



US00D460590S

(12) **United States Design Patent**  
**Hodge et al.**

(10) **Patent No.:** **US D460,590 S**  
(45) **Date of Patent:** **\*\* Jul. 16, 2002**

- (54) **STORAGE BIN FOR RECYCLABLES**
- (76) Inventors: **Edwyn Hodge; George Eric Blue**, both of 1345 5th Ave. Apt 18 D, New York City, NY (US) 10029
- (\*\*) Term: **14 Years**
- (21) Appl. No.: **29/136,917**
- (22) Filed: **Feb. 9, 2001**
- (51) **LOC (7) Cl.** ..... **09-09**
- (52) **U.S. Cl.** ..... **D34/1**
- (58) **Field of Search** ..... D34/1, 5, 6, 7; 220/908, 909, 910, 911; D32/37

5,267,668 A	*	12/1993	Jones	.....	220/908
D344,381 S	*	2/1994	Martin et al.	.....	D34/7
D347,923 S	*	6/1994	Martin et al.	.....	D34/7
D353,248 S	*	12/1994	Brussing	.....	D34/1
D353,249 S	*	12/1994	Hallenbeck	.....	D34/1
5,381,916 A		1/1995	Strawder		
5,392,942 A	*	2/1995	Hanson	.....	220/909
5,547,097 A	*	8/1996	Lyon	.....	220/909
5,558,254 A		9/1996	Anderson et al.		
5,662,235 A		9/1997	Nieto		
5,878,904 A		3/1999	Schweigert		
D430,372 S	*	8/2000	Howard et al.	.....	D34/1
D447,303 S	*	8/2001	Howard et al.	.....	D34/1

\* cited by examiner

*Primary Examiner*—Cynthia E. Ramirez

(56) **References Cited**

**U.S. PATENT DOCUMENTS**

D142,274 S	*	8/1945	Kohen	.....	D32/37
D142,649 S	*	10/1945	Kohen	.....	D32/37
2,573,548 A	*	10/1951	Cunningham	.....	220/908
2,648,495 A	*	8/1953	Borst	.....	220/908
3,958,715 A	*	5/1976	Capelli	.....	220/909
4,834,262 A	*	5/1989	Reed	.....	220/908
D319,519 S	*	8/1991	Keir	.....	D34/7
5,044,644 A	*	9/1991	Duran et al.	.....	220/908
5,118,173 A	*	6/1992	Proctor et al.	.....	220/909
D329,313 S	*	9/1992	Ward et al.	.....	D34/7
D330,618 S	*	10/1992	Browning et al.	.....	D34/7
D331,302 S	*	11/1992	Clapp et al.	.....	D34/7
D332,681 S		1/1993	Waterson et al.		
D332,848 S	*	1/1993	Williams	.....	D34/5
D333,026 S	*	2/1993	Befus	.....	D34/7
5,203,618 A	*	4/1993	Oshall	.....	220/909
D335,730 S	*	5/1993	Tessner et al.	.....	D34/7
D336,696 S	*	6/1993	Bateman et al.	.....	D32/37
D339,891 S	*	9/1993	Simmons et al.	.....	D34/7
D340,333 S	*	10/1993	Duran et al.	.....	D34/7

(57) **CLAIM**

The ornamental design for a storage bin for recyclables, as shown and described.

**DESCRIPTION**

FIG. 1 is a front elevational view of the storage bin for recyclables of the present invention;  
 FIG. 2 is a rear elevational view of the storage bin for recyclables of FIG. 1;  
 FIG. 3 is a right side elevational view of the storage bin for recyclables of FIG. 1, the left view being a mirror image thereof;  
 FIG. 4 is a top plan view of the storage bin for recyclables of FIG. 1;  
 FIG. 5 is a bottom plan view of the storage bin for recyclables of FIG. 1; and,  
 FIG. 6 is a top, front, right side perspective view with one of the bins partially removed.

**1 Claim, 4 Drawing Sheets**

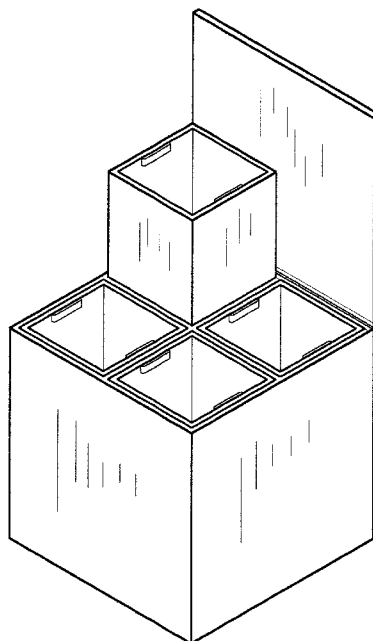

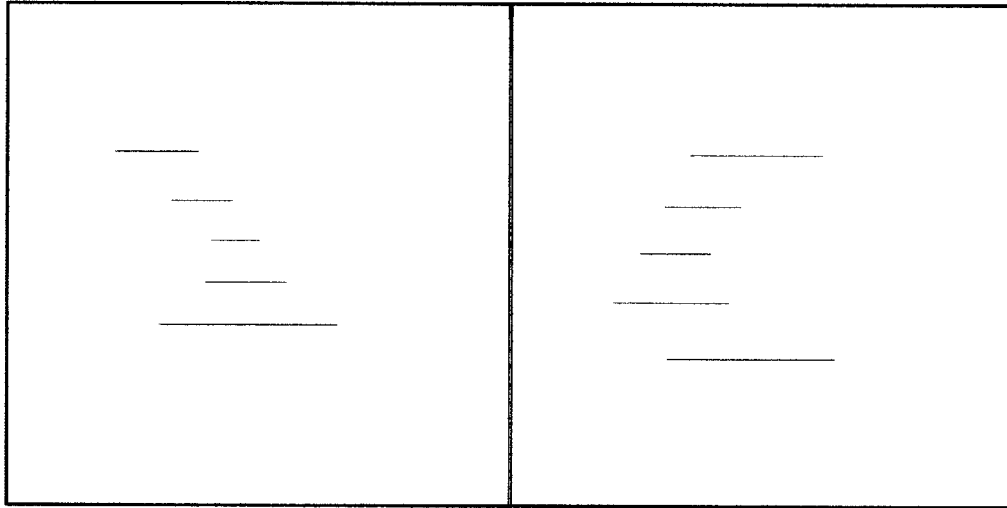

FIG. 2

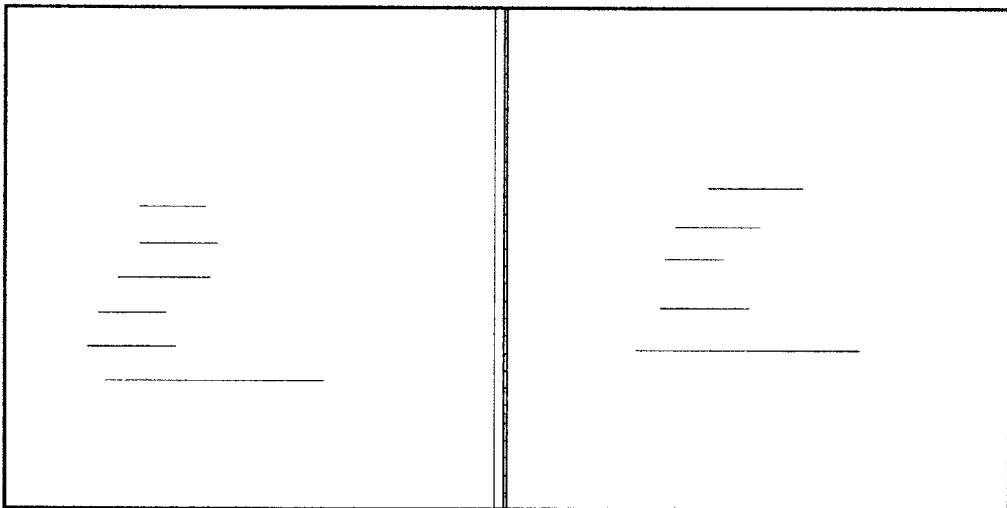

FIG. 1

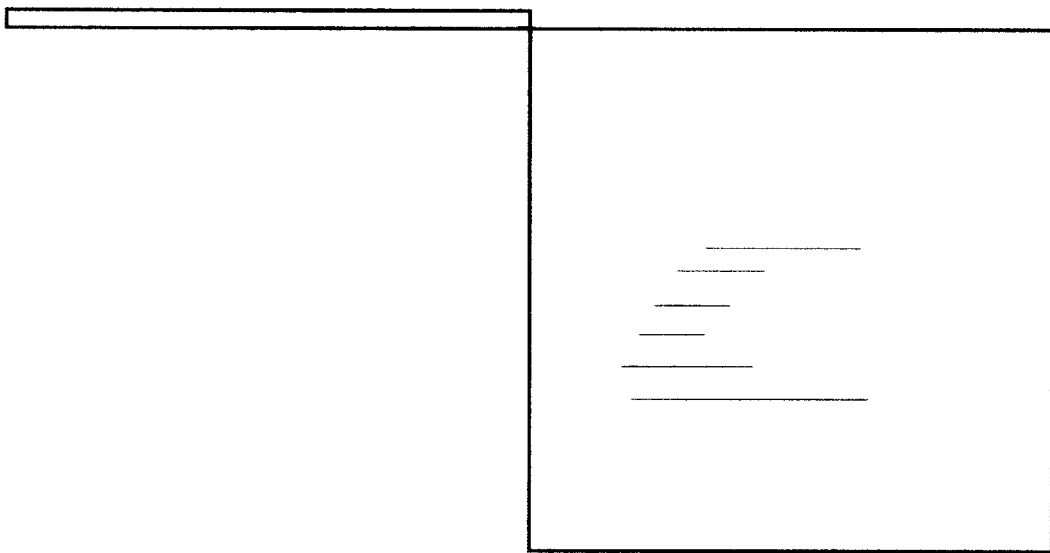

FIG. 3

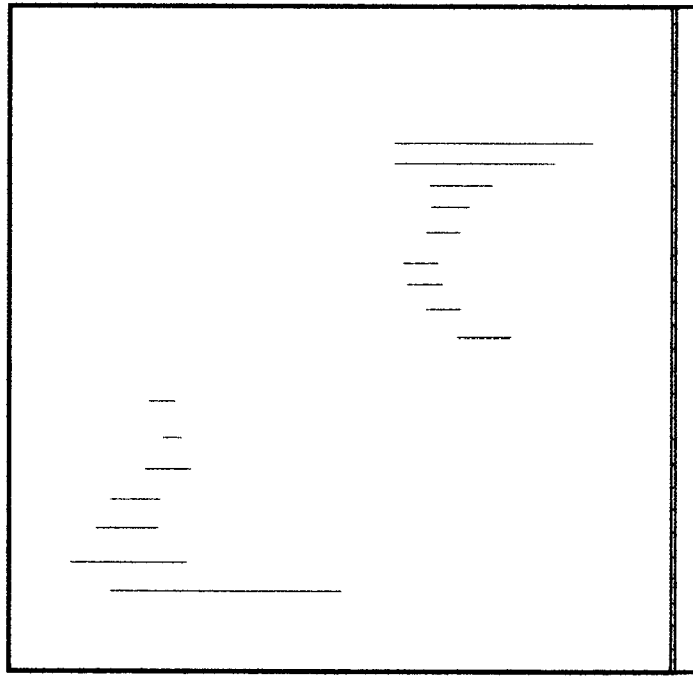

FIG. 5

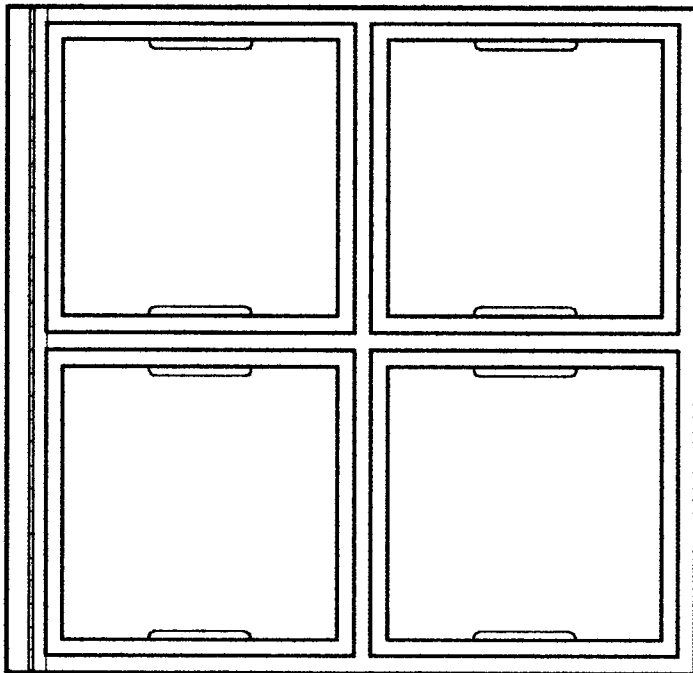

FIG. 4

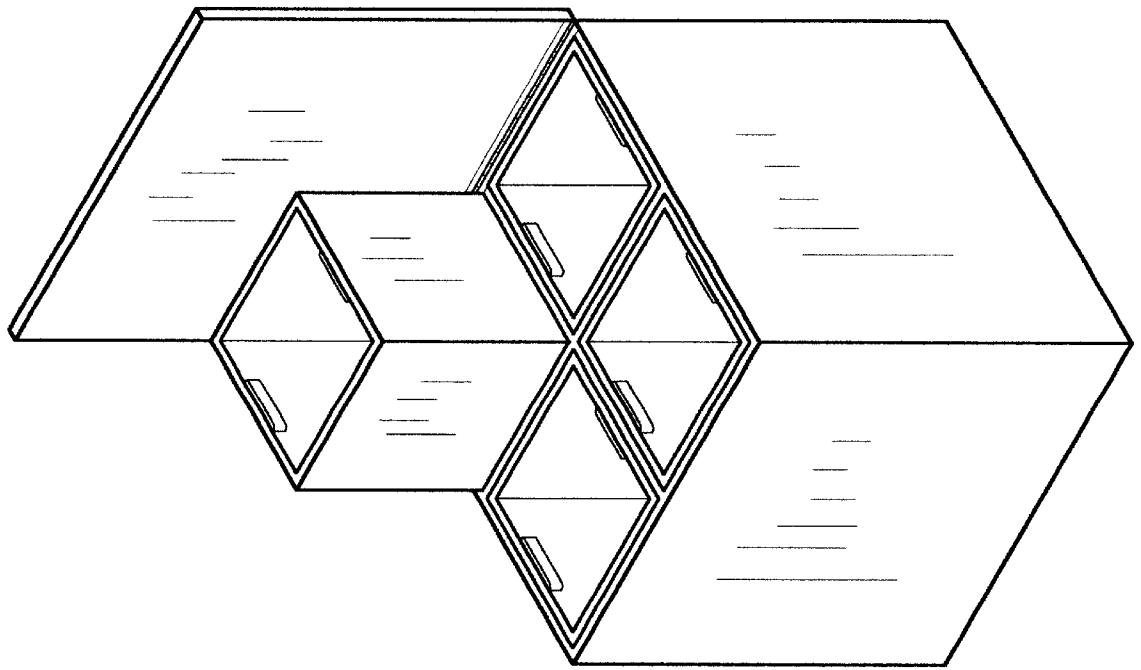

FIG. 6