



(11) **EP 2 165 960 A1**

(12) **EUROPEAN PATENT APPLICATION**  
published in accordance with Art. 153(4) EPC

(43) Date of publication:  
**24.03.2010 Bulletin 2010/12**

(51) Int Cl.:  
**B66B 1/32 (2006.01)**

(21) Application number: **08702998.9**

(86) International application number:  
**PCT/JP2008/050127**

(22) Date of filing: **09.01.2008**

(87) International publication number:  
**WO 2009/008183 (15.01.2009 Gazette 2009/03)**

(84) Designated Contracting States:  
**AT BE BG CH CY CZ DE DK EE ES FI FR GB GR HR HU IE IS IT LI LT LU LV MC MT NL NO PL PT RO SE SI SK TR**  
Designated Extension States:  
**AL BA MK RS**

(72) Inventors:  
• **KONDO, Rikio**  
Tokyo 100-8310 (JP)  
• **KIGAWA, Hiroshi**  
Tokyo 100-8310 (JP)  
• **UEDA, Takaharu**  
Tokyo 100-8310 (JP)  
• **HASHIMOTO, Jun**  
Tokyo 100-8310 (JP)

(30) Priority: **10.07.2007 PCT/JP2007/063707**

(71) Applicant: **Mitsubishi Electric Corporation**  
**Chiyoda-ku**  
**Tokyo 100-8310 (JP)**

(74) Representative: **HOFFMANN EITL**  
**Patent- und Rechtsanwälte**  
**Arabellastrasse 4**  
**81925 München (DE)**

(54) **ELEVATOR**

(57) An elevator apparatus, which can gently stop a car when causing the car normally running to make an emergency stop, and can suddenly stop the car when causing the car running with a door open to make an emergency stop, is provided. For this purpose, when the car of an elevator which is normally running is caused to make an emergency stop, a braking device is caused to

generate a braking force while a deceleration of the car is controlled. Meanwhile, when a predetermined running condition with a door open of the car is determined, the braking device is caused to generate a braking force so that a stopping distance of the car becomes shorter than that in the case of causing the car which is normally running to make an emergency stop.

Fig. 2

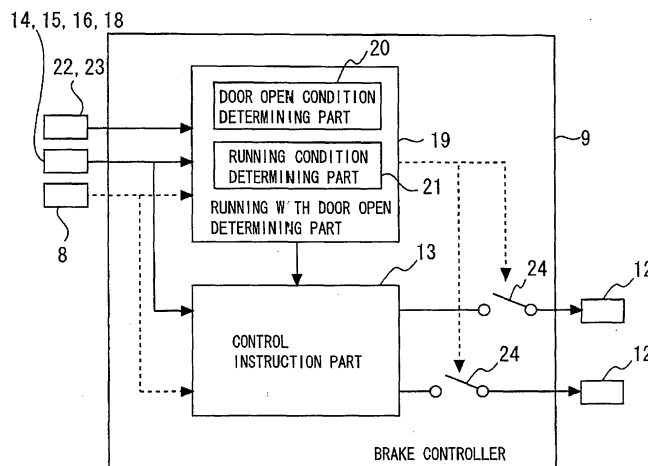

EP 2 165 960 A1

## Description

### Technical Field

[0001] The present invention relates to an elevator apparatus.

### Background Art

[0002] In elevator apparatus, car and counterweight of elevator are generally suspended in a well bucket manner by a main rope, and the main rope is wound on the driving sheave of a traction machine, whereby rotation of the driving sheave is controlled to cause the car to run and stop. Further, when a user gets on and off the elevator of the above described configuration, the above described car is stopped at a predetermined landing position, and the car at this time is stopped and held by a stopping and holding force of a braking device included in the above described traction machine. More specifically, at the time of a normal operation of an elevator, the above described braking device operates at the time of stoppage of the car.

[0003] Meanwhile, at the time of emergency, the above described braking device also operates when the car runs, and causes the car to make an emergency stop. As the prior art of such an elevator apparatus, there is proposed the one that does not give discomfort to a user by controlling the braking force of the braking device so as to stop a car gently, when causing the car to make an emergency stop from the running condition, for example (see Patent Document 1).

[0004] Patent Document 1: Japanese Patent Laid-Open No. 7-206288

### Disclosure of the Invention

#### Problems to be Solved by the Invention

[0005] In an elevator apparatus, the braking device is operated at the time of stoppage of the car as described above, and therefore, the car does not start running with the door open. However, in the elevator apparatus including a releveling function, for example, the car position is corrected when the car lands, and therefore, the car is sometimes caused to run at a low speed with the door open. The releveling function refers to the function of returning the car to the predetermined landing position by automatically correcting the car position, when the extending quantity of the main rope increases and decreases as a result of the number of passengers in the car changing, and the car is in a position different from the predetermined landing position.

[0006] When an emergency stop of the car is required during the releveling operation, if the car is to be stopped gently as the one described in Patent Document 1, the stopping distance of the car naturally becomes long, and there arises the problem that the space between a door

and an elevator hall cannot be sufficiently secured according to circumstances.

[0007] The present invention is made in order to solve the problem as described above, and an object of the present invention is to provide an elevator apparatus which can gently stop a car when the car is caused to make an emergency stop from a normal running condition, and can suddenly stop the car when the car is caused to make an emergency stop from a running condition with a door open, that is, a running condition during a releveling operation.

#### Means for Solving the Problems

[0008] An elevator apparatus of the present invention is an elevator apparatus that comprises a car which ascends and descends in an elevator shaft, a braking device stopping the car at a time of landing of the car in a normal operation, a control instruction part causing the braking device to generate a braking force while controlling a deceleration of the car when causing the car which is normally running to make an emergency stop, and a running with door open determining part causing the braking device to generate a braking force so that a stopping distance of the car becomes shorter than that in a case of causing the car which is normally running to make an emergency stop, upon determining a predetermined running condition with the door of the car open.

[0009] Also, an elevator apparatus of the present invention is an elevator apparatus that comprises a car which ascends and descends in an elevator shaft, a braking device stopping the car at a time of landing of the car in a normal operation, a control instruction part causing the braking device to generate a braking force while controlling a deceleration of the car when causing the car which is normally running to make an emergency stop, door open and close condition detecting means detecting an open and close condition of a door, speed detecting means detecting a speed of the car, and a running with door open determining part changing control of a braking force of the braking device correspondingly to a condition of an elevator at a time of causing the car to make an emergency stop on the basis of a detection result of the door open and close condition detecting means and a detection result of the speed detecting means, and that is **characterized in that** the running with door open determining part causes the braking device to generate a braking force so that a stopping distance of the car becomes shorter than that in a case where a predetermined door open condition is not determined when the predetermined door open condition is determined, and causes the braking device to generate a braking force so that the stopping distance of the car becomes shorter than that in a case where the predetermined door open condition is determined and a speed of the car exceeds a predetermined value when the predetermined door open condition is determined and the speed of the car is the predetermined value or lower.

## Effect of the Invention

**[0010]** According to the present invention, when the car is caused to make an emergency stop from a normal running condition, the car can be gently stopped, and when the car is caused to make an emergency stop from a running condition with a door open, that is, a running condition during a releveling operation, the car can be suddenly stopped.

## Brief of Description of the Drawings

**[0011]**

Figure 1 is a general block diagram showing an elevator apparatus in First Embodiment according to the present invention.

Figure 2 is a block diagram of an essential part showing the elevator apparatus in First Embodiment according to the present invention.

Figure 3 shows diagrams for explaining the operation of the elevator device in First Embodiment according to the present invention.

Figure 4 shows diagrams for explaining the operation of the elevator apparatus in First Embodiment according to the present invention.

Figure 5 is a flowchart showing part of the operation of the elevator apparatus in Fourth Embodiment according to the present invention.

Figure 6 shows diagrams for explaining the operation of the elevator apparatus in Fourth Embodiment according to the present invention.

Figure 7 shows diagrams for explaining the operation at the time of limiting the stopping distance by controlling the safety relay at the time of an emergency stop.

Figure 8 shows diagrams for explaining another operation at the time of limiting the stopping distance by controlling the safety relay at the time of an emergency stop.

Figure 9 shows diagrams for explaining another operation at the time of limiting the stopping distance by controlling the safety relay at the time of an emergency stop.

## Description of symbols

**[0012]**

- 1 car,
- 2 counterweight,
- 3 main rope,
- 4 traction machine,
- 5 driving sheave,
- 6 motor,
- 7 braking device,
- 8 controller,
- 9 brake controller,

- 10 brake wheel,
- 11 brake lining,
- 12 brake coil,
- 13 control instruction part,
- 5 14 accelerometer,
- 15 load weighing device,
- 16 traction machine encoder,
- 17 governor,
- 18 governor encoder,
- 10 19 running with door open determining part,
- 20 door open condition determining part,
- 21 running condition determining part,
- 22 door open and close detection sensor,
- 23 floor position sensor,
- 15 24 safety relay,
- 25 boundary line,
- 26 shaded area,
- 27 boundary line,
- 28 shaded area,
- 20 29 boundary line

## Best Mode for Carrying Out the Invention

**[0013]** In order to describe the present invention in more detail, the present invention will be described in accordance with the attached drawings. In each of the drawings, the same or corresponding parts are assigned with the same reference numerals, and overlaps of description of these parts are appropriately simplified or omitted.

## First Embodiment

**[0014]** Figure 1 is a general block diagram showing an elevator apparatus in First Embodiment according to the present invention, and Figure 2 is a block diagram of an essential part showing the elevator apparatus in First Embodiment according to the present invention. In Figures 1 and 2, reference numeral 1 denotes a car which ascends and descends in an elevator shaft; reference numeral 2 denotes a counterweight which ascends and descends in the direction opposite from the car 1 in the shaft; reference numeral 3 denotes a main rope which suspends the car 1 and the counterweight 2 in a well bucket manner; and reference numeral 4 denotes a traction machine for an elevator which drives the car 1 via the main rope 3. The above described main rope 3 may be other suspending means such as a belt.

**[0015]** The above described traction machine 4 is configured by, for example, a driving sheave 5, a motor 6 and a braking device 7. By controlling the rotation of the driving sheave 5 on which the above described main rope 3 is wound by the motor 6, the car 1 is caused to run (ascend and descend) and stop. Reference numeral 8 is a controller which conducts operation control of the entire elevator, and the operation instruction to the motor 6 is given by the controller 8. Further, at the time of boarding and alighting of users, the car 1 is stopped at a prede-

terminated landing position, and the car 1 at this time is stopped and held by the stopping and holding force of the above described braking device 7. Reference numeral 9 denotes a brake controller which controls the operation of the braking device 7 on the basis of input signals and the like from the controller 8.

**[0016]** Here, the concrete configuration of the above described braking device 7 will be described.

Reference numeral 10 denotes a brake wheel which rotates by relating to the driving sheave 5; reference numeral 11 denotes a brake lining which is always urged to the brake wheel 10 side by a repulsive force of an elastic body not illustrated; and reference numeral 12 denotes a brake coil which generates a electromagnetic force to separate the brake lining 11 from the brake wheel 10. At the time of landing of the car 1 in a normal operation, the braking device 7 inhibits rotation of the driving sheave 5 by the frictional force which occurs as a result of the brake lining 11 being pressed against the brake wheel 10, and stops and holds the car 1. Further, at the time of running of the car 1, the brake lining 11 is separated from the brake wheel 10 by the electromagnetic force which is generated by the brake coil 12 to bring the driving sheave 5 into a rotatable condition.

**[0017]** Meanwhile, when the car 1 which normally runs is caused to make an emergency stop, the above described brake controller 9 operates the braking device 7 on the basis of the instruction received from the controller 8 to brake the car 1. At this time, the brake controller 9 refers to the condition of the car 1, and calculates the speed and deceleration which are required for gently stopping the car 1. The brake controller 9 causes the braking device 7 to generate a braking force while controlling the deceleration so as to stop the car 1 gently on the basis of the calculation result. More specifically, when an electromagnetic brake is adopted as the braking device 7 as in the elevator apparatus shown in Figure 1, the voltage which is applied to the brake coil 12 is controlled to regulate the magnitude of the force (braking force) for pressing the brake lining 11 against the brake wheel 10.

**[0018]** Specifically, the above described operation of the brake controller 9 is performed by a control instruction part 13 which controls the braking force of the braking device 7. The control instruction part 13 compares, for example, the target condition of the car 1 and the present condition, and regulates the magnitude of the braking force so that the car 1 follows the target condition.

**[0019]** The present condition of the car 1 is determined on the basis of the condition signal from the controller 8 and the condition signal from the car 1. Here, for the above described condition signal, a signal of a sensor or the like which is directly placed at the car 1 may be used, or a signal of a sensor or the like which is placed at the part which relates to the car 1 may be used. The sensor which is directly placed at the car 1 means, for example, an accelerometer 14 placed at a ceiling part of the car 1, a load weighing device 15 which is placed between a car

frame and an end portion of the main rope 3, and the like. Further, the sensor provided at the part which relates to the car 1 means, for example, a traction machine encoder 15, a governor encoder 18 which is placed at a governor 17, and the like.

**[0020]** Next, the operation at the time of causing the car 1 which is normally running to make an emergency stop will be described based on Figure 3 (Figures 3a to 3c). Figure 3 shows diagrams for explaining the operation of the elevator device in First Embodiment according to the present invention, Figure 3a shows the change with time of the car position at the time of causing the car which normally runs with the door closed to make an emergency stop, Figure 3b shows the change with time of the car speed at that time, and Figure 3c shows the change with time of the car deceleration at that time.

**[0021]** In Figures 3a to 3c, the condition quantities which are expressed differ, but A to D show the condition quantity changes of the common system conditions of the respective codes. Specifically, in the drawings, A corresponds to the case where in the condition that the weight difference of the car 1 and the counterweight 2 works on the running car 1 to the acceleration side, the braking device 7 is caused to generate the maximum braking force, and the car 1 is suddenly stopped. Further, B corresponds to the case where in the condition that the weight difference of the car 1 and the counterweight 2 works on the running car 1 to the deceleration side, the braking device 7 is caused to generate the maximum braking force, and the car 1 is suddenly stopped. In contrast with this, C corresponds to the case where the braking force of the braking device 7 is controlled in the same condition as A and the car 1 is gently stopped, and D corresponds to the case where the braking force of the braking device 7 is controlled in the same condition as B, and the car 1 is gently stopped.

**[0022]** As is understood from Figures 3a to 3c, by controlling the braking force so as to cause the deceleration of the car 1 to follow the target deceleration, the car 1 can be gently stopped without giving discomfort to users. In such a case, the distance by which the car 1 advances before the car 1 stops naturally becomes long as shown in Figure 3a. However, at the time of normal running, the car door and the hall door are completely closed, and even if the stopping distance becomes long, a problem does not especially occur.

**[0023]** Meanwhile, the brake controller 9 includes a running with door open determining part 19 in addition to the above described control instruction part 13. The running with door open determining part 19 is means for detecting that the car 1 is in a predetermined running condition with a door open, and when determining the above described predetermined running condition with the door open on the basis of the input signal and the like from the controller 8, the running with door opening determining part 19 outputs an instruction for suddenly stopping the car 1 to the control instruction part 13. Specifically, the running with door open determining part 19

causes the braking device 7 to generate a braking force so that the stopping distance of the car 1 becomes shorter than that in the above described case where the car 1 which normally runs is caused to make an emergency stop by detecting that the car 1 is in a predetermined running condition with the door open.

**[0024]** The running with door open determining part 19 is configured by, for example, a door open condition determining part 20 and a running condition determining part 21. The door open condition determining part 20 determines the condition with a door open. Determination of the door open condition can be realized by various methods using door open and close condition detecting means which detects the open and close conditions of a door. The door open condition can be determined by using, for example, a detection signal of a door open and close detection sensor 22 which directly detects the movement of a door, a current and a voltage of an actuator which drives the door, a detection signal of a sensor (not illustrated) which detects the operation of the above described actuator, and the like.

**[0025]** Specifically, when the detection signal of the door open and close detection sensor 22 is used, the door open and close detection sensor 22 may be installed at the car door, or may be installed at the hall door. However, the hall door is installed in each elevator hall, and therefore, when the door open and close detection sensor 22 is installed at the hall door, it needs to be installed at the hall door of each floor. Meanwhile, when the door open and close detection sensor 22 is installed at the car door, it only has to be installed in one spot, and therefore, it can be configured at low cost to provide the advantages of being excellent in installation easiness and maintainability.

**[0026]** Further, the door open condition also can be determined by determining whether torque occurs so as to keep a door close condition, and determining that the door closes by detecting the change with time of the torque at the time of opening and closing operation of the door, from the change in current and voltage of the actuator which drives the door. Further, movement of the door is detected by referring to the encoder which controls the above described actuator and a resolver signal, and the door open condition can be determined.

**[0027]** Meanwhile, the above described running condition determining part 21 determines the running condition of the car 1. Determination of the running condition can be realized by various methods by detecting the position, speed and deceleration of the car 1 by using the running condition detecting means which detects the running condition of the car 1. The running condition of the car 1 can be determined by a signal from, for example, the aforementioned accelerometer 14, load weighing device 15, traction machine encoder 16, governor encoder 18 or a floor position sensor 23. All of these signals are not required. Specifically, if only at least one signal can be obtained, it can be easily determined whether or not the car 1 is in the predetermined running condition by

finding the speed of the car 1.

**[0028]** The above is the description of the case where the running with door open determining part 19 is configured by the door open condition determining part 20 and the running condition determining part 21, but the running with door open determining part 19 only has to have both the functions of the above described determining parts 20 and 21, and the predetermined running condition with the door open also can be detected by the determining method shown as follows, for example. When the signal from the accelerometer 14 is used, it can be determined whether or not the car 1 is in the predetermined running condition with the door open by only the signal from the accelerometer 14, depending on the measure such as use of the signal as the signal corresponding to the speed by integrating the magnitude of the signal. Further, the load weighing device 15 can detect the apparent weight change in the car 1 at the time of acceleration and deceleration of the car 1. Therefore, by detecting the acceleration and deceleration of the car 1 with the door opening and closing operation or the like as the reference by using the signal from the load weighing device 15, it can be determined whether or not the elevator is in a normal running condition. The above described floor position sensor 23 detects that the car 1 is in a position shifting from the landing position by a fixed quantity or more, and detects the shift quantity. Therefore, by determining that the car 1 lands in a position which differs from the landing position by a predetermined distance or more by using the signal from the floor position sensor 23, it can be determined that the car is in a predetermined running condition with the door open.

**[0029]** In this way, the running with door open determining part 19 can determine the running condition with the door open by various methods. Therefore, when the elevator apparatus includes a plurality of detecting devices for determining running with the door open, the running with door open determining part 19 may determine that the predetermined running condition with the door open when the running condition with the door open is detected by all of the detecting devices, or may determine that the car 1 is in the predetermined running condition with the door open when the running condition with the door open is detected by any one of the detecting devices. Alternatively, it may be configured to determine whether or not the car 1 is in the running condition with the door open on the basis of the number of detecting devices which detect the running condition with the door open, or decision by majority.

**[0030]** In the case shown in Figure 2, the running with door open determining part 19 determines that the car 1 is in the running condition with the door open when the predetermined door open condition is determined by the door open condition determining part 20 and the predetermined running state of the car 1 is determined by the running condition determining part 21, for example. When the running condition with the door open of the car 1 is detected by the running with door open determining

part 19, the control instruction part 13 controls the braking force of the braking device 7 so that the car 1 can stop within the necessary and sufficient short distance, or stops the control of the braking force to cause the braking device 7 to generate the maximum braking force.

**[0031]** Specifically, when the predetermined running condition with the door open is determined by the running with door open determining part 19 is determined, the control instruction part 13 sets the target deceleration at a larger value than the case of the emergency stop in the running condition with the door closed, or cuts off the energization to the electromagnetic brake, so that a large braking force is generated. Further, when a safety relay 24 is provided in the energization part as in the brake controller 9 shown in Figure 2, the safety relay 24 may be configured to be opened in accordance with the instruction from the control instruction part 13 or the running with door open determining part 19 to cut off energization to the electromagnetic brake reliably.

**[0032]** Here, Figure 4 (Figures 4a to 4c) shows diagrams for explaining the operation of the elevator apparatus in First Embodiment according to the present invention. Specifically, Figure 4a shows the change with time of the car position when the car 1 which runs with door open is caused to make an emergency stop, Figure 4b shows the change with time of the car speed at that time, and Figure 4c shows the change with time of the car deceleration at that time.

**[0033]** In Figures 4a to 4c, the condition quantities which are expressed differ, but E and F express the condition quantity changes of the common system conditions of the respective codes. More specifically, E corresponds to the case where the car 1 is gently stopped while the braking force of the braking device 7 is controlled in the condition in which the car 1 starts running with the door open after it stops at the regular landing position. F corresponds to the case where the braking device 7 is caused to generate the maximum braking force in the same condition as E, and the car 1 is suddenly stopped. The time bases of Figures 4a to 4c are common, the point at which running with the door open is started is set as the running with the door open starting point, a predetermined running condition with the door open is detected by the brake controller 9, and the point at which the emergency stop by the braking device 7 is started is set as an emergency stop operation starting point.

**[0034]** As is known from Figures 4a to 4c, by causing the braking device 7 to generate the maximum braking force by stopping control of the braking force (or controlling the braking force of the braking device 7 by the predetermined method), the stopping distance of the car 1 can be significantly reduced as compared with the case of gently stopping the car 1. Accordingly, even if the elevator apparatus is brought into an emergency stop condition during a releveling operation, the car 1 can be immediately stopped, and the space between the door and the elevator hall can be sufficiently secured.

**[0035]** According to First Embodiment of the present

invention, when the car 1 which normally runs is caused to make an emergency stop, the car 1 can be gently stopped, and the situation which gives discomfort to a user does not occur. Further, when the car 1 which runs with the door open is caused to make an emergency stop, the car 1 can be suddenly stopped, and the space between the door and the elevator hall can be sufficiently secured. In the above described First Embodiment, the case where the running with door open determining part 19 is provided inside the brake controller 9 is described, but the means having the similar function may be provided outside. Further, for example, when the signals from the controller 8 include the signal corresponding to the determining signal of running with the door open, the predetermined running condition with the door open is determined from only the signal, and this can be reflected in transmission to the control instruction part 13 and the operation of the safety relay 24.

## 20 Second Embodiment

**[0036]** When the car 1 in the predetermined running condition with the door open is caused to make an emergency stop, a maximum speed  $V$  the car 1 can have (hereinafter, called "running with door open upper limit speed") can be calculated by the following expression.

**[0037]**

[Expression 1]

$$V = \int_{t_1}^{t_2} \alpha(t) dt$$

$$\alpha(t) = F_{mot} + F_{nub} - F(t)$$

Each constant in the above described expressions, and each constant in the expressions shown as follows are based on the operation of the car 1. Here,  $\alpha(t)$  represents the acceleration of the car 1 with a time  $t$  as the argument,  $t_1$  represents a time at which a releveling operation starts,  $t_2$  represents a time at which the car speed becomes maximum after the running with door open determining part 19 outputs an emergency stop instruction,  $F_{mot}$  is the maximum value of the force of the power of the traction machine 4, which accelerates the car 1 and the part relating to it,  $F_{nub}$  is the maximum value of the force of the weight imbalance of the car 1 and the counterweight 2, which accelerates the car 1 and the part relating to it, and  $F(t)$  represents the minimum value of the braking force by the brake with the time  $t$  as the argument. Further, the argument  $t$  in each function is the time with the time of starting an emergency stop being set as a reference time 0. The part relating to the above described car 1 refers to the drive parts of the car 1, the counterweight 2, the traction machine rotor, the rope and the like. Further, the following expression is an equilibrium equation after an emergency stop instruction is output, and

thereby, the above described t2 is determined.

[Expression 2]

$$F_{mot} + F_{nub} - F(t2) = 0$$

In the above described expression, the term  $F_{mot}$  which represents the power of the traction machine 4 is present, but at the time of an emergency stop operation, the power transmission of the traction machine 4 is cut off, and therefore, in a normal elevator,  $F_{mot}=0$  is set. Further, t1 is determined from the following equation.

[Expression 3]

$$t1 = -\sqrt{\frac{2MX}{F_{nub} + F_{mot}}}$$

M represents a total inertial mass with respect to the car 1 and the part relating to it, and X represents a maximum moving quantity of the car 1 until the running with door open determining part 19 outputs an emergency stop instruction after a releveling operation is started.

[0038] Further, since the above described moving quantity (displacement quantity) X is usually a short distance, the running with door open upper limit speed V is calculated as a low speed from the above described expression. Therefore, in the case of an emergency stop from a normal running condition, the initial speed of the car 1 becomes larger than the running with door open upper limit speed V in many cases (see Figure 3b). Further, in the case of an emergency stop from running with the door open, the initial speed of the car 1 becomes smaller than the running with door open upper limit speed V in any case (see Figure 4b).

[0039] Accordingly, the running with door open determining part 19 can determine the predetermined running condition with the door open of the car 1 with the above described running with door open upper limit speed V as the reference. In this case, speed detecting means that detects the speed of the car 1 is required. When the running with door open determining part 19 causes the car 1 to make an emergency stop (for example, when receiving an emergency stop instruction from the controller 8, and when detecting running when the car 1 should stop originally), if the speed of the car 1 detected by the above described speed detecting means is a predetermined speed or higher, and is the above described running with door open upper limit speed V or lower, the running with door open determining part 19 determines that there is the possibility of running with the door open, and causes the braking device 7 to generate a braking force so that

the stopping distance of the car 1 becomes shorter than the case where the speed of the car 1 is detected as larger than the running with door open upper limit speed V. Specifically, in such a case, the running with door open determining part 19 determines that the car 1 is in the predetermined running condition with the door open irrespective of the actual door open condition, and suddenly stops the car 1. By such an operation, determination of the door open condition on the basis of a signal or the like from the door open and close detection sensor 22 becomes unnecessary.

[0040] In the above described determining method, even when the car 1 which normally runs is caused to make an emergency stop, the situation can happen, in which it is determined as running with the door open and the car 1 is suddenly stopped. However, in such a case, the car 1 which is to be suddenly stopped runs at a very low speed. Therefore, the time until stop is short, and the car 1 can be stopped before the breaking force sufficiently works. Accordingly, discomfort is not given to the users.

Third Embodiment

[0041] When an emergency stop instruction is issued from the controller 8 or the like, if the running with door open determining part 19 (door open condition determining part 20) determines a predetermined door open condition, the brake controller 9 causes the braking device 7 to generate a braking force so that the stopping distance of the car 1 becomes shorter than the case where the door open condition is not detected. Specifically, in such a case, the brake controller determines that the car 1 is in the predetermined running condition with the door open irrespective of the actual running condition of the car 1, and always stops the car 1 suddenly. Thereby, the car 1 can be stopped with the space between the door and the elevator hall being sufficiently secured. According to Third Embodiment of the present invention, the brake controller 9 does not have to determine the running condition, and the advantage of being capable of simplifying the configuration is obtained.

Fourth Embodiment

[0042] In an elevator, the door is completely closed during normal running. However, in an elevator, the situation is assumed, in which a passenger in the car 1 deliberately opens the door while the car 1 is running. In such a case, in the elevator, the safety system operates to cause the car 1 to make an emergency stop.

[0043] On the occasion of the emergency stop which is made for such a reason, if the method shown in Second Embodiment is applied, the car 1 is likely to run a long distance while it is in a door open condition according to circumstances. For example, when the speed of the car 1 when the door is deliberately opened by a passenger is the predetermined speed such as the running with door open upper limit speed V, or lower, the car 1 stops in a

short stopping distance by the control for sudden stop being performed. Therefore, a problem does not especially occur. However, when the speed of the car 1 at the time of door open exceeds the above described predetermined speed, the braking force of the braking device 7 is controlled without a special limitation for gently stopping the car 1, and therefore, the distance before the car 1 stops, that is, the running distance with the door open sometimes becomes long.

**[0044]** Meanwhile, if the method shown in Third Embodiment is applied when the above described emergency stop is made, when the door open condition is determined, control for sudden stop is performed irrespective of the speed of the car 1 at that time. Therefore, there is the fear of occurrence of deceleration which is excessively higher than necessary. For example, in an ordinary elevator as shown in Figure 1, that is, an elevator of the configuration in which the car 1 and the counterweight 2 are suspended by the main rope 3 in the well bucket manner, sudden stop is made by forcefully braking the rotating driving sheave 5. Namely, by suddenly braking the driving sheave 5, the car 1 is decelerated and stopped by using the frictional force of the driving sheave 5 and the main rope 3 which is wound on the driving sheave 5.

**[0045]** Therefore, at the time of an emergency stop of the car 1, slipping occurs between the driving sheave 5 and the main rope 3 according to circumstances. The slipping quantity, namely, the difference between the rotating quantity of the driving sheave 5 and the moving quantity (advancing quantity) of the main rope 3 generally becomes larger as the speed of the car 1 is higher. Accordingly, when the speed of the car 1 when the door is opened by a passenger is high, the stopping distance of the car 1 sometimes becomes long due to slipping which occurs between the driving sheave 5 and the main rope 3.

**[0046]** Fourth Embodiment has an object to solve the aforementioned problem by properly changing control for the braking device 7 at the time of an emergency stop of the car 1 correspondingly to three conditions of an elevator. Hereinafter, a concrete operation of the elevator apparatus in this embodiment will be described.

**[0047]** Figure 5 is a flowchart showing part of the operation of the elevator apparatus in Fourth Embodiment according to the present invention. In the brake controller 9, when an emergency stop instruction is issued from the controller 8 or the like (S101), the open and close condition of the door is determined first in the running with door open determining part 19 (S102). When a predetermined door open condition is not determined by the door open condition determining part 20 here (No in S102), the brake controller 9 performs control corresponding to the first elevator condition (hereinafter, called "case 1") for the braking device 7.

**[0048]** Meanwhile, when the door open condition determining part 20 determines the predetermined door open condition, the running with door open determining part 19 determines whether or not the speed of the car 1 is higher than the running with door open upper limit

speed V (S103). If the running condition determining part 21 determines that the speed of the car 1 is the running with door open upper limit speed V or lower (Yes in S103), the brake controller 9 performs control corresponding to a second elevator condition (hereinafter, also called "case 2") for the braking device 7. Further, when the running condition determining part 21 determines that the speed of the car 1 is higher than the running with door open upper limit speed V (No in S103), the brake controller 9 carries out the control corresponding to a third elevator condition (hereinafter, also called "case 3") for the braking device 7.

Hereinafter, the concrete control performed by the brake controller 9 in the cases 1 to 3 will be described.

<Case 1 (case where the car 1 in the door close condition is caused to make an emergency stop)>

**[0049]** The brake controller 9 controls the braking force of the braking device 7 without a special limitation in order to stop the car 1 gently. This is because if the door is in the completely closed condition, there is no problem if the stopping distance of the car 1 becomes long, and if a limitation is placed on the stopping distance, there is the case of being incapable of sufficiently obtaining the effect corresponding to the original object of controlling the braking device 7, that is, gently stopping the car 1.

**[0050]** When the car 1 is excessively gently decelerated without a special limitation in the vicinity of the terminal floor, the car 1 enters the edge of the shaft, and the car 1 may be considered to stop by the safety device such as a buffer. Even in such a case, a problem does not especially occur to safety. However, in order not to operate the above described safety device, the stopping distance may be restrained from being long within the range from which the effect of gently stopping the car 1 can be obtained.

<Case 2 (case where the car 1 which runs in the predetermined door open condition, and at a predetermined speed such as the running with door open upper limit speed V, or lower is caused to make an emergency stop)>

**[0051]** The brake controller 9 controls the braking force of the braking device 7 so that the car 1 can stop in a necessary and sufficient short distance, or stops the control of the braking force to cause the braking device 7 to generate the maximum braking force. In such a case, the speed of the car 1 at the time of an emergency stop is low, and therefore, the car 1 stops before the braking force of the braking device 7 rises to the maximum. Accordingly, the deceleration which occurs at the time of an emergency stop is small, and slipping hardly occurs between the driving sheave 5 and the main rope 3. Further, since the speed of the car 1 is low, even if slipping occurs between both of the above described driving sheave 5 and the main rope 3, the slipping quantity is small, and the stopping distance does not become long.

Further, the car 1 is suddenly decelerated intentionally, and therefore, a sufficient space is secured between the door and the elevator hall.

<Case 3 (case where the car 1 which runs in the predetermined door open condition and at a speed exceeding the predetermined speed such as the running with door open upper limit speed V is caused to make an emergency stop)>

**[0052]** The brake controller 9 controls the braking force of the braking device 7 so that the car 1 decelerates at a deceleration at which slipping does not occur between the driving sheave 5 and the main rope 3 while controlling the stopping distance so that the car 1 stops within the allowable distance. This is for preventing the stopping distance from being long by adding restriction to the distance by which the car 1 runs with the door open, and for preventing the stopping distance from being long by slipping which occurs between the driving sheave 5 and the main rope 3.

**[0053]** As above, when the predetermined door open condition is determined at the time of the emergency stop of the car 1, the brake controller 9 (running with door open determining part 19) causes the braking device 7 to generate a braking force so that the stopping distance of the car 1 becomes shorter than that in the case where the predetermined door open condition is not determined. Further, even when the predetermined door open condition is determined, if the speed of the car 1 is the predetermined speed such as the running with door open upper limit speed V, or lower, the brake controller 9 causes the braking device 7 to generate a braking force so that the stopping distance of the car 1 becomes shorter than that in the case in which the speed of the car 1 exceeds the above described predetermined speed.

**[0054]** Since such a function is included, in the above described case 3, a limitation is placed on the stopping distance unlike the case 1. Hereinafter, a concrete method at the time of setting a limitation to the stopping distance will be described.

Figure 6 (Figures 6a to 6c) shows diagrams for explaining the operation of the elevator apparatus in Fourth Embodiment according to the present invention. Specifically, Figure 6a shows a change with time of the car position when the car 1 is caused to make an emergency stop, Figure 6b shows a change with time of the car speed at that time, and Figure 6c shows a change with time of a car deceleration at that time.

**[0055]** In Figures 6a to 6c, the condition quantities which are expressed differ, but A to D express the condition quantity changes of the common system conditions of the respective codes. Specifically, in the drawings, A corresponds to the case where the car 1 is suddenly stopped by causing the braking device 7 to generate the maximum braking force without performing control of the braking force. B corresponds to the case where the car 1 is stopped by performing control of the braking force

which is performed in the above described case 3 for the braking device 7. Further, C corresponds to the case where the car 1 is stopped by performing control of the braking force which is performed in the above described case 1 for the braking device 7.

**[0056]** As is understood from Figures 6a to 6c, in the case shown by B, a limitation is placed on the stopping distance of the car 1, and therefore, the target deceleration is set to be the value higher than the target deceleration in C. The control instruction part 13 controls the braking device 7 so that the actual deceleration follows the set target deceleration in both of B and C. Accordingly, the speed change of the car 1 at the time of an emergency stop has a larger inclination (inclination in Figure 6b) in the case of B than C, and the stopping distance of B naturally becomes shorter than the stopping distance of C.

**[0057]** The case where the control of the braking force which is performed in the above described case 2 is performed for the braking device 7, and the car 1 is stopped corresponds to the case of F which is described in First Embodiment by citing Figure 4. In the case 2, when a sufficient space can be reliably secured between the door and the elevator hall, the braking force of the braking device 7 may be configured to be controlled by setting the high target deceleration as shown in the case 3.

**[0058]** The limitation on the stopping distance shown in the case 3 may be performed by the operation of the control instruction part 13. Further, when the brake controller 9 has the configuration shown in Figure 2, the function of limiting the above described stopping distance may be realized by operating (controlling) the safety relay 24 by the running with door open determining part 19 or the like.

Hereinafter, a concrete method and its effect when limiting the stopping distance by performing open and close control of the safety relay 24 will be described based on Figures 7 to 9.

**[0059]** Figure 7 (Figures 7a to 7c) shows diagrams for explaining the operation at the time of limiting the stopping distance by controlling the safety relay at the time of an emergency stop. Specifically, Figure 7a shows a change with time of the car position at the time of causing the car 1 to make an emergency stop, Figure 7b shows a change with time of the car speed at that time, and Figure 7c shows a change with time of the car deceleration at that time. In Figures 7a to 7c, the expressed condition quantities differ, but A to D and B' express the state quantity changes of the common system conditions of the respective codes. Further, Figure 7b shows a boundary line 25 and a speed area which is lower than the boundary line 25, and is shown by a shaded area 26. Details of the above described boundary line 25 will be described later.

**[0060]** Open and close control of the safety relay 24 is performed on the basis of the result of comparing the present speed of the car 1 detected by the speed detecting means and the speed shown in the above described

boundary line 25. Specifically, the operation instruction is output to the safety relay 24 from the running with door open determining part 19 to close the safety relay 24 when the present speed of the car 1 is lower than the speed shown by the boundary line 25, and to open the safety relay 24 when the present speed of the car 1 is higher than the speed shown by the boundary line 25.

**[0061]** Next, the respective condition changes of A to D and B' in Figures 7a to 7c will be described.

A corresponds to the case where the weight difference of the car 1 and the counterweight 2 works on the running car 1 most to the acceleration side and the case where the car 1 is suddenly stopped by causing the braking device 7 to generate the maximum braking force without performing control of the braking force. B corresponds to the case where the traction ability reduces in the condition of A, and slipping occurs between the driving sheave 5 and the main rope 3. Specifically, B represents the condition in the case where the car 1 does not decelerate most in this elevator system. B' represents the condition quantity of the driving sheave 5 at the time of the condition quantity of the car 1 becoming B.

**[0062]** C corresponds to the case where the weight difference of the car 1 and the counterweight 2 works on the running car 1 to the decelerating side and the case where the car 1 is gently stopped by controlling the braking force of the braking device 7 so that the deceleration follows the target deceleration. Here, in C, if the speed of the car 1 which is detected by the speed detecting means exceeds the boundary line 25, that is, the speed becomes higher than the speed shown by the boundary line 25, the car 1 is decelerated by causing the braking device 7 to generate the maximum braking force by opening the safety relay 24.

**[0063]** The boundary line 25 is in the condition in the case where the car 1 does not decelerate most as described above, and therefore, even if the car 1 which runs at the speed on the boundary line 25 is decelerated by the above described maximum braking force, the speed does not exceed the speed change line shown by B of Figure 2. For example, D shows the condition quantity of the case where the car 1 is brought into the condition where the car 1 does not decelerate most in the elevator system at a point i of C (the point at which the speed of the car 1 exceeds the boundary line 25 in C). In the case shown by D, the speed of the car 1 does not exceed B. Specifically, the boundary line 25 is determined as the relationship of each time and speed at which the speed does not exceed the speed of B when the speed change line corresponding to D is assumed from the predetermined speed on the boundary line 25 which corresponds to each time.

**[0064]** By performing open and close control of the safety relay 24 with the boundary line 25 thus set as a reference, the speed of the car 1 can be kept at the speed in the case where the car 1 does not decelerate most in the elevator system, or at a speed lower than this, and the stopping distance at the time of an emergency stop

becomes reliably shorter than the case shown by B. Specifically, in the design of an elevator, occurrence of the stopping distance as shown by B is planned, and when the stopping distance becomes shorter than this, the stopping distance which is longer than planned is not likely to occur due to the influence by control of the braking force of the braking device 7.

**[0065]** At the time of determining the boundary line 25, the shaded area 26 which is under the boundary line 25 can be taken to be large by setting each speed for each time on the line to be high. Thereby, the condition in which the braking force of the braking device 7 can be relieved by closing the safety relay 24 becomes large, and the deceleration reduction effect which is the original function can be exhibited well.

The above is the example of the case of shortening the stopping distance by setting the boundary line 25 so as not to exceed the speed in the case where the car 1 does not decelerate most when the braking device 7 is caused to generate the maximum braking force.

**[0066]** Next, based on Figure 8, another setting method of the boundary line 25 will be described.

Figure 8 (Figures 8a and 8b) shows diagrams for explaining another operation at the time of limiting the stopping distance by controlling the safety relay at the time of an emergency stop. Specifically, Figure 8 shows an example of the open and close operation of the safety relay 24 which allows the stopping distance longer than the case where the car 1 does not decelerate most in the case 1, but prevents entry of the car 1 into the edge of the shaft by stopping the car 1 within the range of the predetermined distance. In the open and close operation of the safety relay 24 shown here, the safety relay 24 is opened and closed with a boundary line 27 of Figure 8b as a reference. Figure 8b shows the case where a shaded area 28 showing the speed area lower than the boundary line 27 shows a trapezoidal shape.

**[0067]** In such a case, when the braking device 7 is caused to generate the maximum braking force by opening the safety relay 24 on the boundary line 27 in the condition in which the car 1 does not decelerate most, the speed change occurs as shown by F, F' and F", for example. Therefore, the speed change does not exceed the speed change line shown by E. Accordingly, when the safety relay 24 is opened and closed with the above described boundary line 27 as a reference, the car 1 can be stopped in the distance shorter than the stopping distance which occurs in the state quantity change of E.

**[0068]** Further, when the car 1 is stopped by causing the braking device 7 to generate the maximum braking force without limiting the stopping distance in the case 2, open and close control of the safety relay 24 can be performed with a boundary line 29 shown in Figure 9b as a reference. The boundary line 29 has the dimension of the speed 0 from the starting point of the emergency stop operation. The condition changes at the time of stop in this case are similar to A, B and B' in Figure 7 as shown by A, B and B' in Figure 9.

**[0069]** From above, the elevator having the configuration of the present embodiment provides the effect that the car 1 can be stopped by placing a limitation on the stopping distance at the time of an emergency stop when the door opens during running, in addition to the effect that the car 1 can be decelerated and stopped at a sufficiently gentle deceleration at the time of an emergency stop in the case where the door is closed, and the effect that the space between the door and the elevator hall can be sufficiently secured at the time of running with the door open.

#### Industrial Applicability

**[0070]** The above described configuration can be applied to all the elevator apparatus without being limited to a predetermined elevator apparatus.

#### Claims

##### 1. An elevator apparatus, comprising:

a car which ascends and descends in an elevator shaft;  
 a braking device stopping the car at a time of landing of the car in a normal operation;  
 a control instruction part causing the braking device to generate a braking force while controlling a deceleration of the car when causing the car which is normally running to make an emergency stop; and  
 a running with door open determining part causing the braking device to generate a braking force so that a stopping distance of the car becomes shorter than that in a case of causing the car which is normally running to make an emergency stop, upon determining a predetermined running condition with the door open.

##### 2. The elevator apparatus according to claim 1, further comprising:

door open and close condition detecting means detecting an open and close condition of a door; and  
 running condition detecting means detecting a running condition of the car, and **characterized in that**  
 when the predetermined door open condition is determined on the basis of a detection result of the door open and close condition detecting means, and a predetermined running condition of the car is determined on the basis of a detection result of the running condition detecting means, the running with door open determining part determines that the car is in a running condition with a door open.

##### 3. The elevator apparatus according to claim 1, further comprising:

speed detecting means detecting a speed of the car, and **characterized in that**  
 when the speed of the car which is detected by the speed detecting means is determined to be lower than a predetermined value when the car is caused to make an emergency stop, the running with door open determining part determines that the car is in a running condition with a door open, irrespective of a door open condition.

##### 4. The elevator apparatus according to claim 1, further comprising:

door open and close condition detecting means detecting an open and close condition of a door, and **characterized in that**  
 when a predetermined door open condition is determined based on a detection result of the door open and close condition detecting means when causing the car to make an emergency stop, the running with door open determining part determines that the car is in a running condition with door open, irrespective of a running state of the car.

##### 5. An elevator apparatus, comprising:

a car which ascends and descends in an elevator shaft;  
 a braking device stopping the car at a time of landing of the car in a normal operation;  
 a control instruction part causing the braking device to generate a braking force while controlling a deceleration of the car when causing the car which is normally running to make an emergency stop;  
 door open and close condition detecting means detecting an open and close condition of a door; speed detecting means detecting a speed of the car; and  
 a running with door open determining part changing control of a braking force of the braking device correspondingly to a condition of an elevator at a time of causing the car to make an emergency stop on the basis of a detection result of the door open and close condition detecting means and a detection result of the speed detecting means, and **characterized in that**  
 the running with door open determining part causes the braking device to generate a braking force so that a stopping distance of the car becomes shorter than that in a case where a predetermined door open condition is not determined when the predetermined door open condition is determined, and

causes the braking device to generate a braking force so that the stopping distance of the car becomes shorter than that in a case where the predetermined door open condition is determined and a speed of the car exceeds a predetermined value when the predetermined door open condition is determined and the speed of the car is the predetermined value or lower.

5

10

15

20

25

30

35

40

45

50

55

Fig. 1

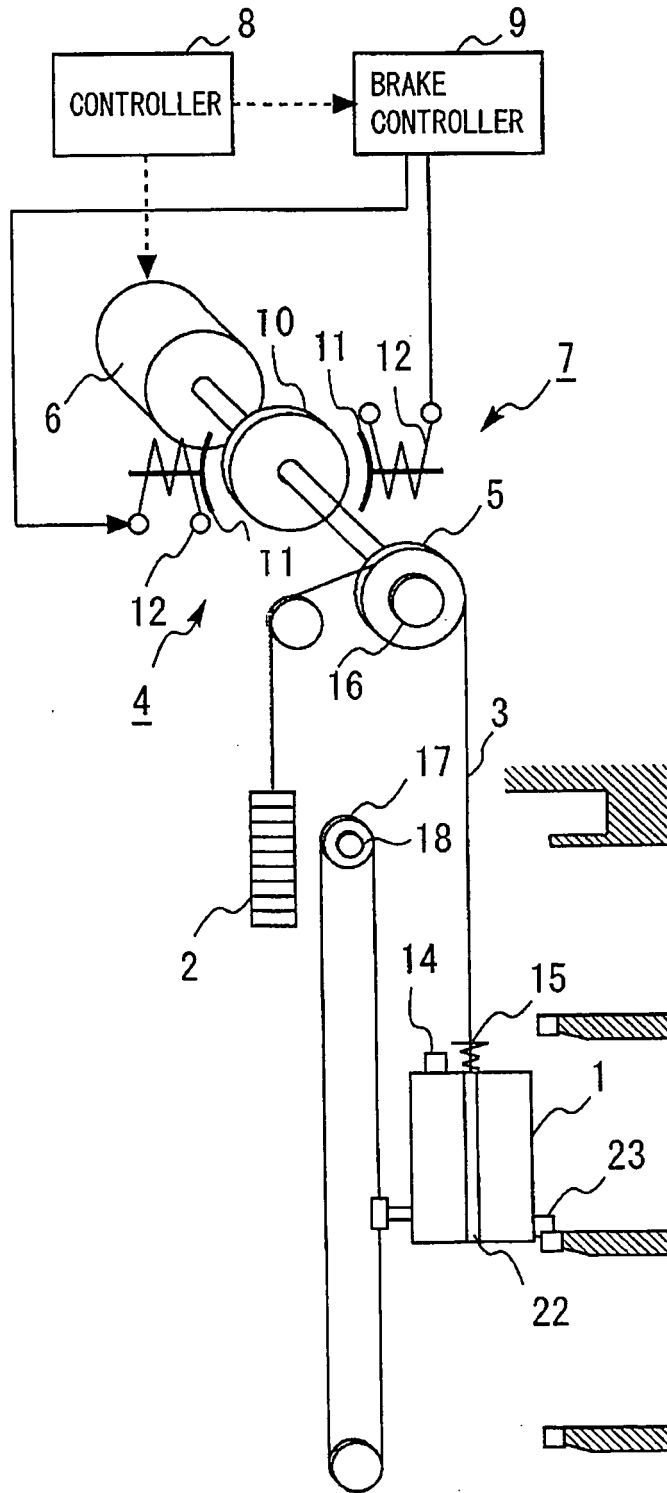

Fig. 2

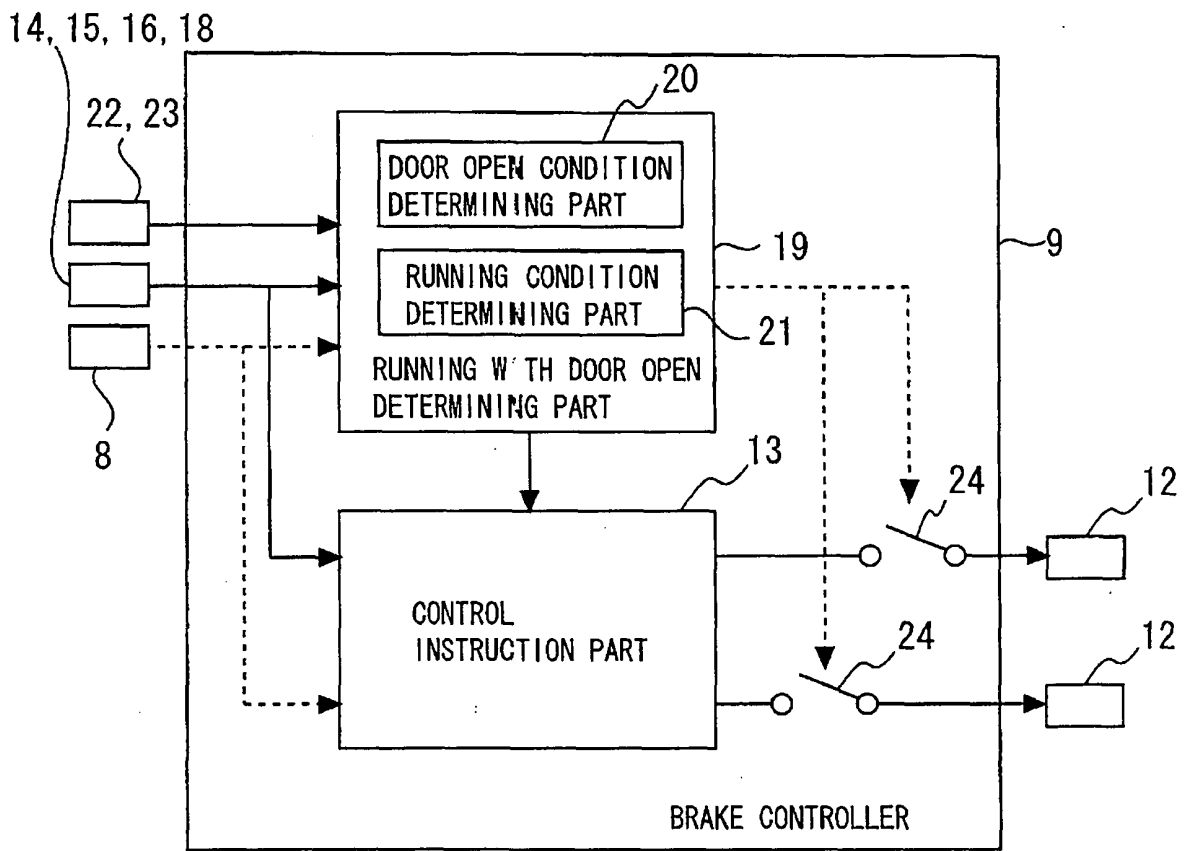

Fig. 3a

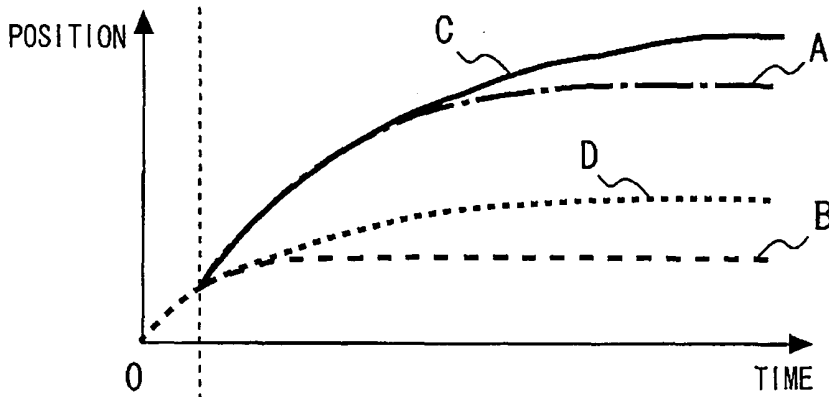

Fig. 3b

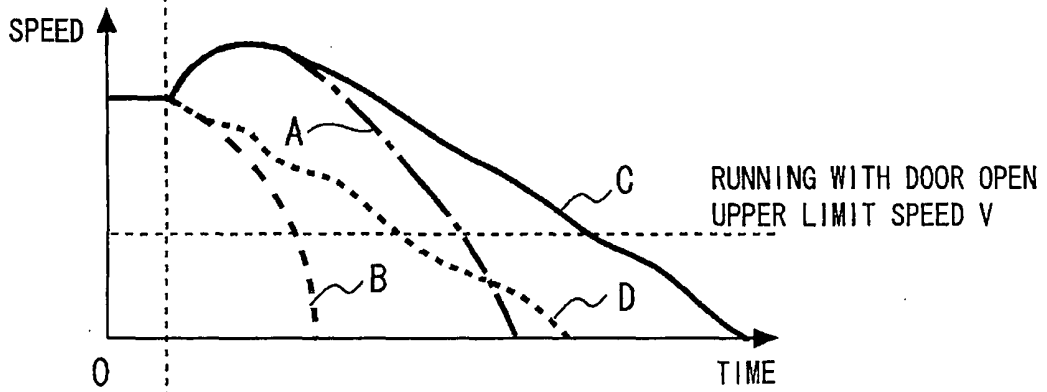

Fig. 3c

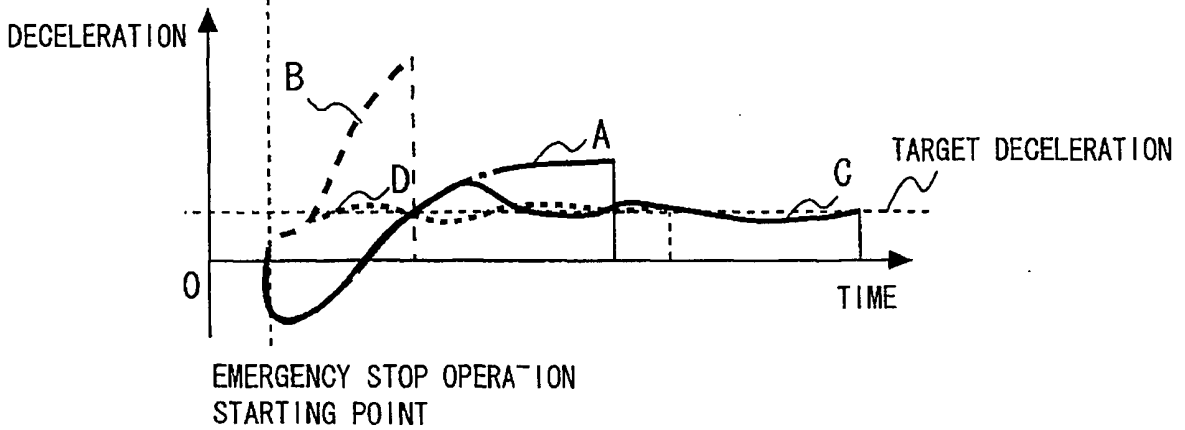

Fig. 4a

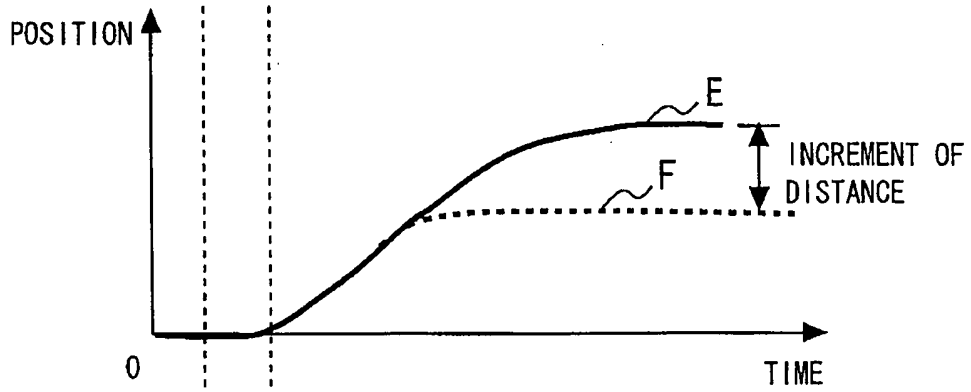

Fig. 4b

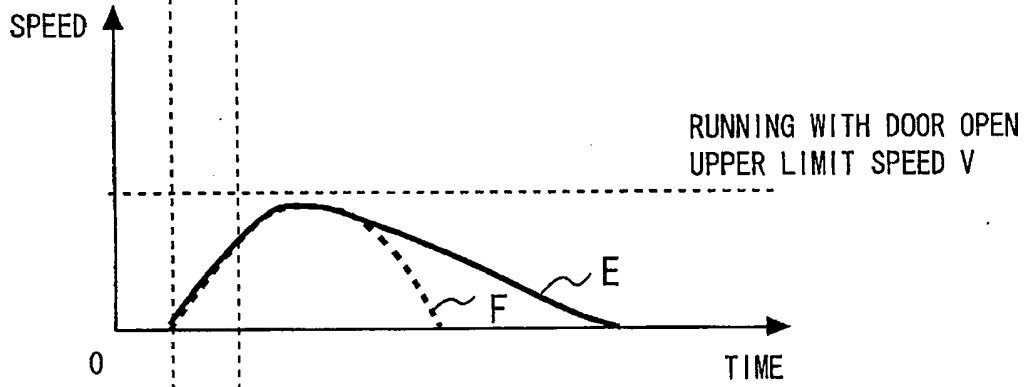

Fig. 4c

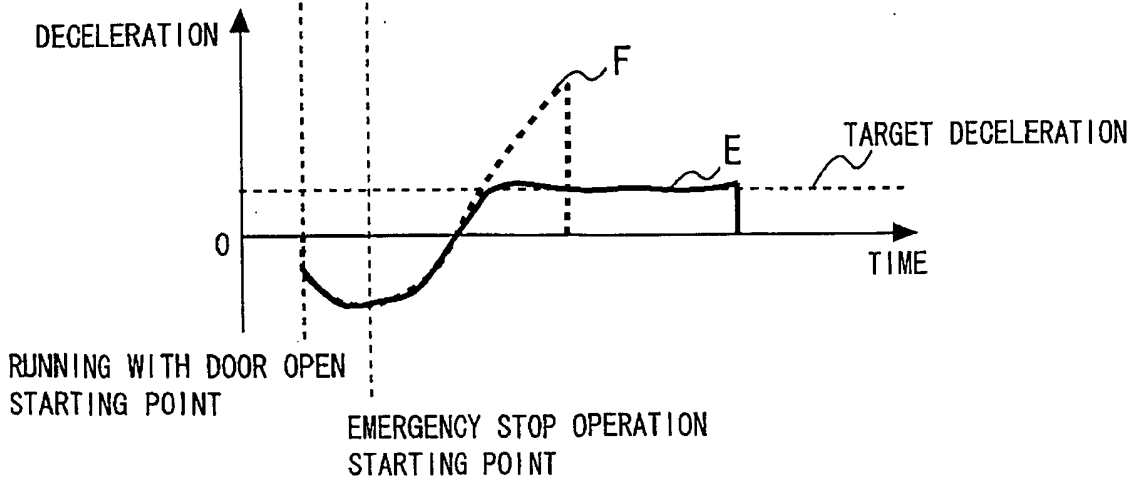

Fig. 5

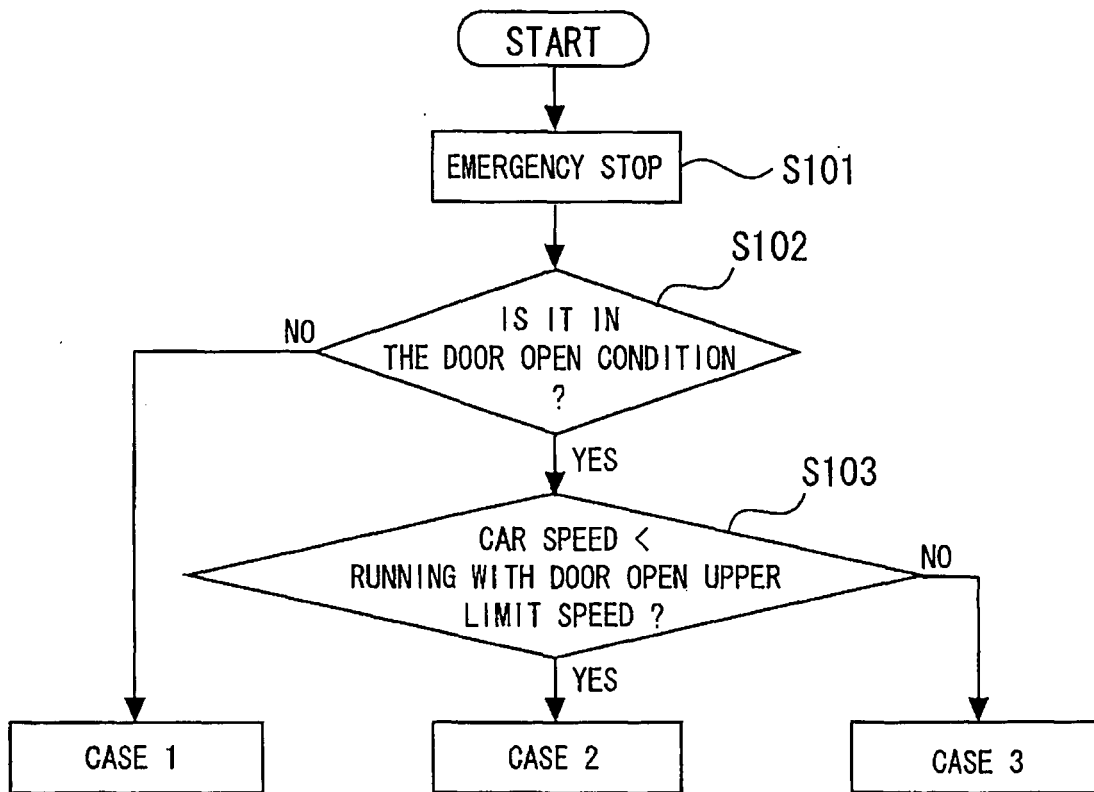

Fig. 6a

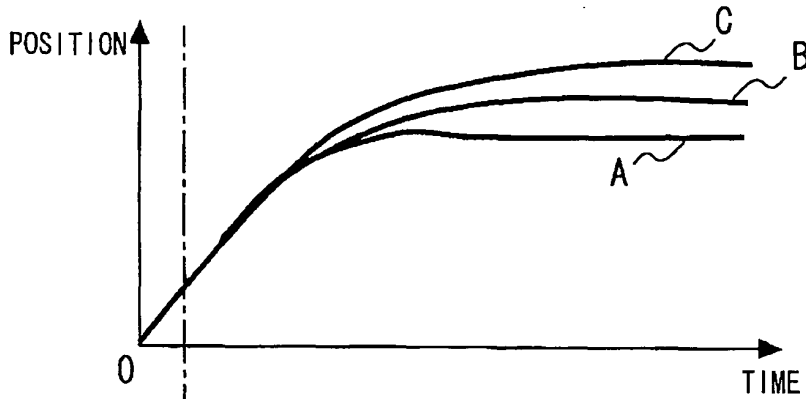

Fig. 6b

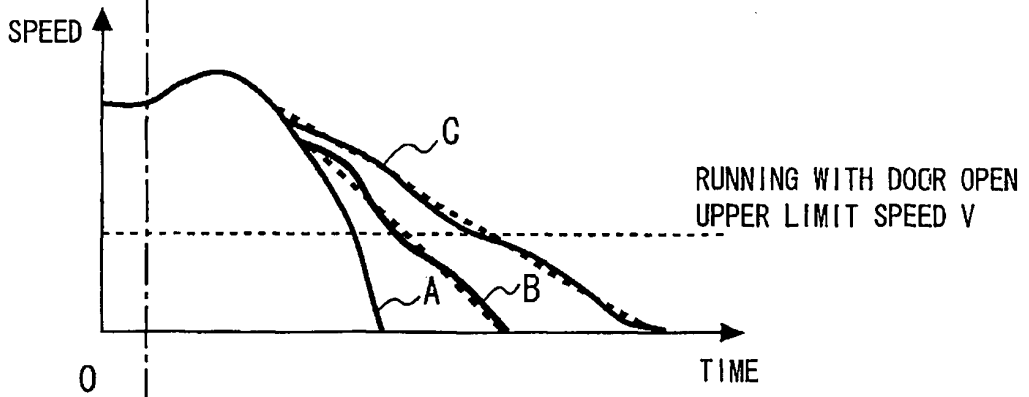

Fig. 6c

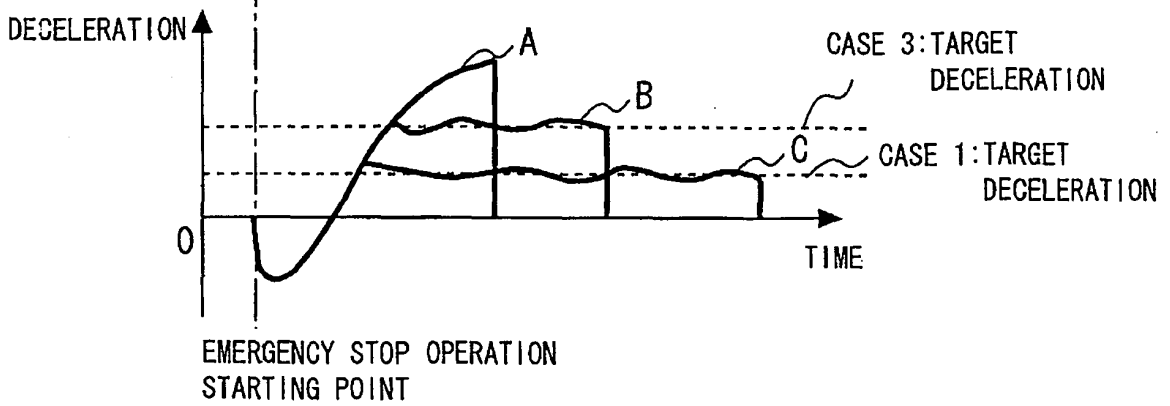

Fig. 7a

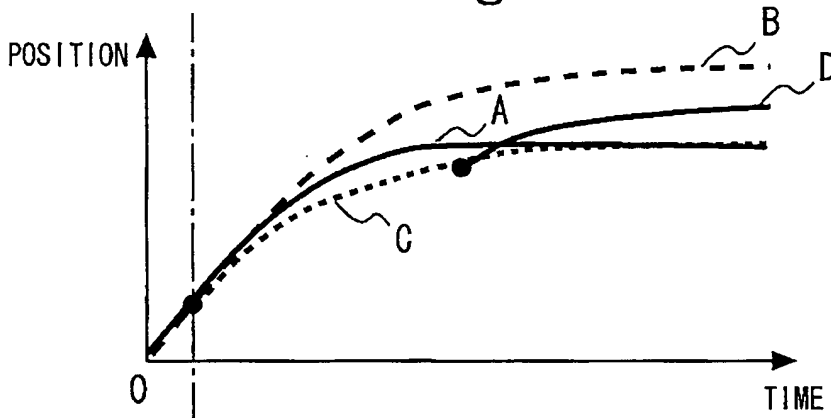

Fig. 7b

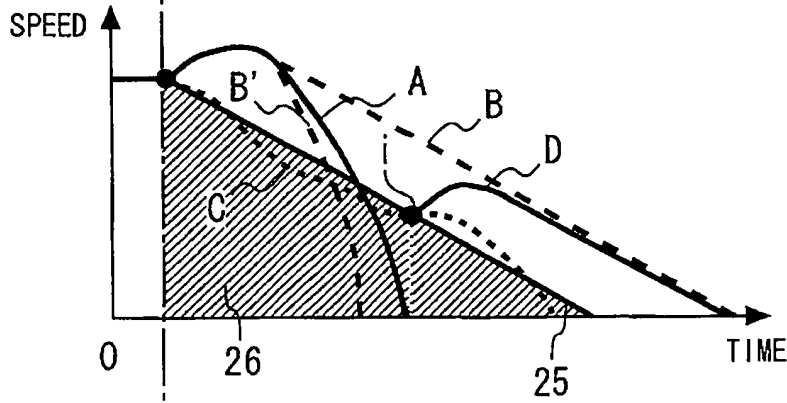

Fig. 7c

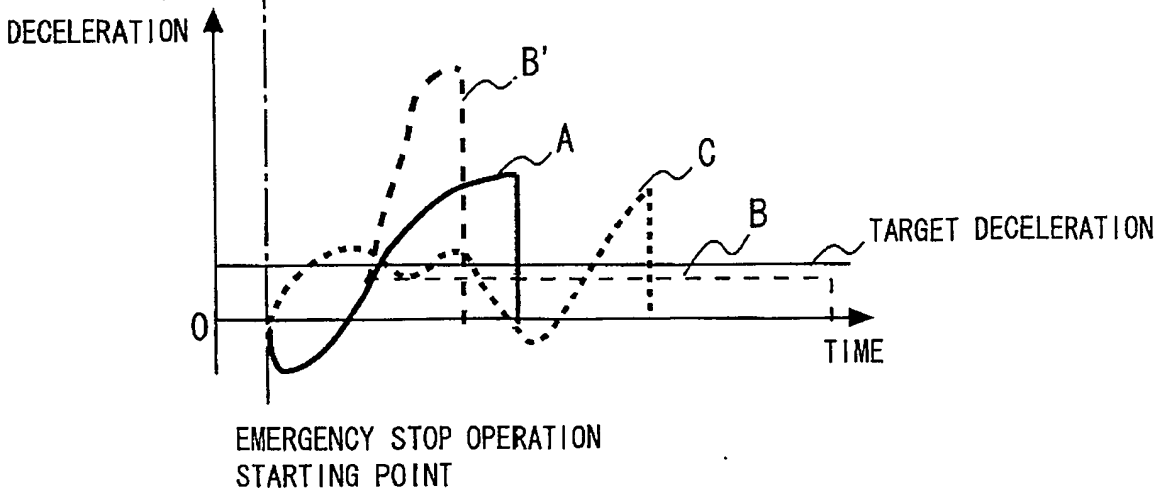

Fig. 8a

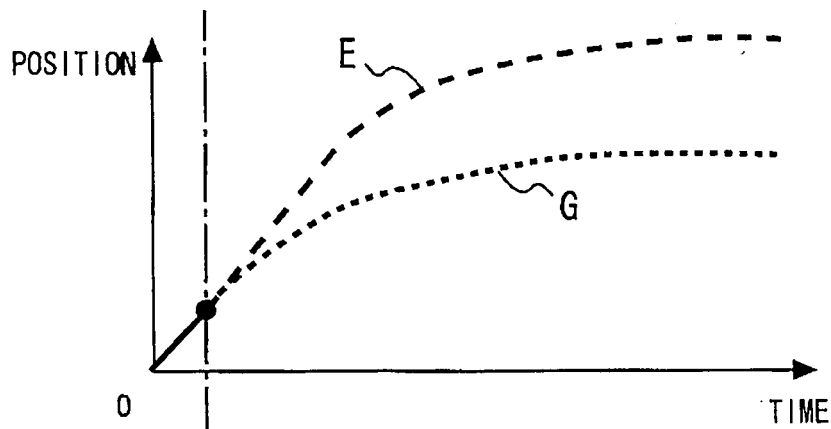
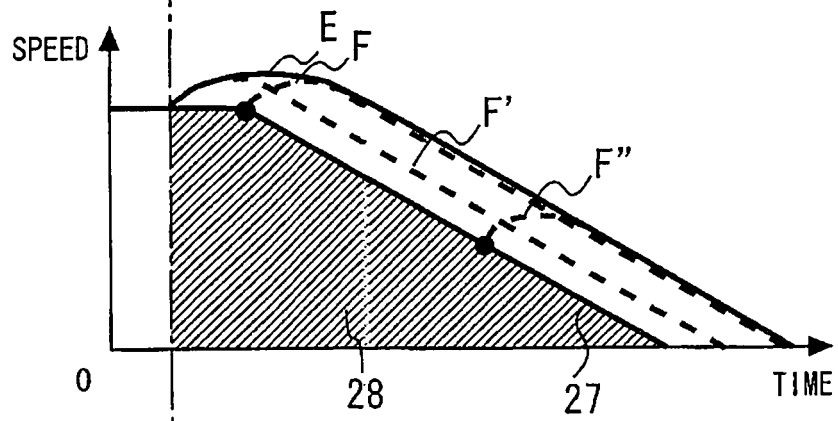

Fig. 8b



EMERGENCY STOP OPERATION  
STARTING POINT

Fig. 9a

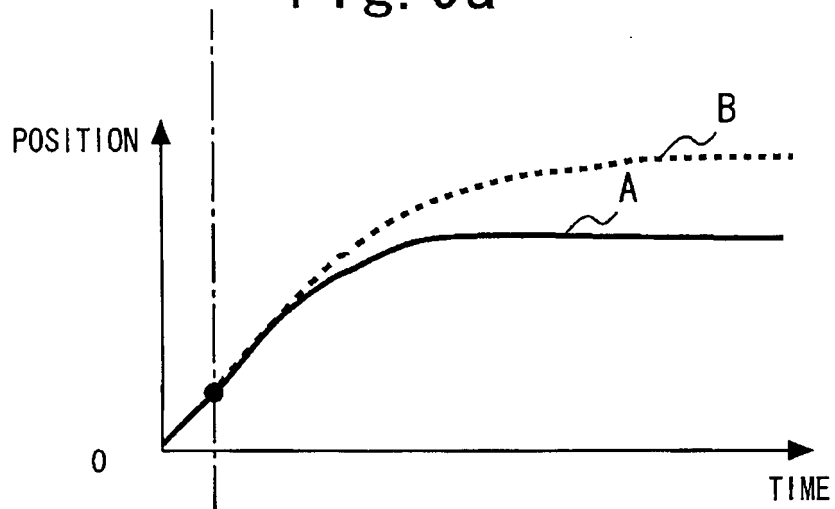
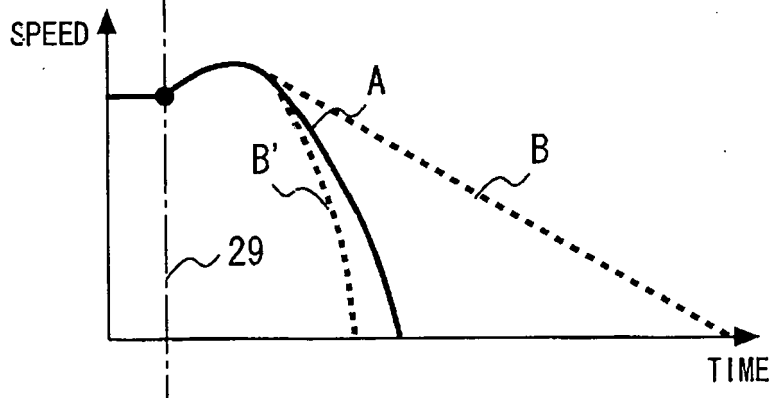

Fig. 9b



EMERGENCY STOP OPERATION  
STARTING POINT

## INTERNATIONAL SEARCH REPORT

International application No.

PCT/JP2008/050127

A. CLASSIFICATION OF SUBJECT MATTER B66B1/32 (2006.01) i		
According to International Patent Classification (IPC) or to both national classification and IPC		
B. FIELDS SEARCHED		
Minimum documentation searched (classification system followed by classification symbols) B66B1/32		
Documentation searched other than minimum documentation to the extent that such documents are included in the fields searched Jitsuyo Shinan Koho 1922-1996 Jitsuyo Shinan Toroku Koho 1996-2008 Kokai Jitsuyo Shinan Koho 1971-2008 Toroku Jitsuyo Shinan Koho 1994-2008		
Electronic data base consulted during the international search (name of data base and, where practicable, search terms used)		
C. DOCUMENTS CONSIDERED TO BE RELEVANT		
Category*	Citation of document, with indication, where appropriate, of the relevant passages	Relevant to claim No.
X Y A	JP 56-117966 A (Mitsubishi Electric Corp.), 16 September, 1981 (16.09.81), (Family: none)	1, 4 2-3 5
X Y A	JP 04-153174 A (Mitsubishi Electric Corp.), 26 May, 1992 (26.05.92), (Family: none)	1, 4 2-3 5
Y A	JP 04-235887 A (Otis Elevator Co.), 24 August, 1992 (24.08.92), & US 5002158 A & CA 2042753 A	2 5
Y A	JP 60-148879 A (Hitachi, Ltd.), 06 August, 1985 (06.08.85), (Family: none)	3 5
<input checked="" type="checkbox"/> Further documents are listed in the continuation of Box C. <input type="checkbox"/> See patent family annex.		
* Special categories of cited documents: "A" document defining the general state of the art which is not considered to be of particular relevance "E" earlier application or patent but published on or after the international filing date "L" document which may throw doubts on priority claim(s) or which is cited to establish the publication date of another citation or other special reason (as specified) "O" document referring to an oral disclosure, use, exhibition or other means "P" document published prior to the international filing date but later than the priority date claimed "T" later document published after the international filing date or priority date and not in conflict with the application but cited to understand the principle or theory underlying the invention "X" document of particular relevance; the claimed invention cannot be considered novel or cannot be considered to involve an inventive step when the document is taken alone "Y" document of particular relevance; the claimed invention cannot be considered to involve an inventive step when the document is combined with one or more other such documents, such combination being obvious to a person skilled in the art "&" document member of the same patent family		
Date of the actual completion of the international search 04 April, 2008 (04.04.08)		Date of mailing of the international search report 15 April, 2008 (15.04.08)
Name and mailing address of the ISA/ Japanese Patent Office		Authorized officer
Facsimile No.		Telephone No.

INTERNATIONAL SEARCH REPORT

International application No.  
PCT/JP2008/050127

C (Continuation). DOCUMENTS CONSIDERED TO BE RELEVANT		
Category*	Citation of document, with indication, where appropriate, of the relevant passages	Relevant to claim No.
A	JP 2004-231355 A (Mitsubishi Electric Corp.), 19 August, 2004 (19.08.04), & CN 1519187 A	5

Form PCT/ISA/210 (continuation of second sheet) (April 2007)

**REFERENCES CITED IN THE DESCRIPTION**

*This list of references cited by the applicant is for the reader's convenience only. It does not form part of the European patent document. Even though great care has been taken in compiling the references, errors or omissions cannot be excluded and the EPO disclaims all liability in this regard.*

**Patent documents cited in the description**

- JP 7206288 A [0004]