



US00D960682S

(12) **United States Design Patent**
Xiang

(10) **Patent No.:** **US D960,682 S**

(45) **Date of Patent:** **** Aug. 16, 2022**

(54) **DOOR HANDLE**

(71) Applicant: **Dezhao Xiang**, Shenzhen (CN)

(72) Inventor: **Dezhao Xiang**, Shenzhen (CN)

(**) Term: **15 Years**

(21) Appl. No.: **29/717,967**

(22) Filed: **Dec. 20, 2019**

(51) **LOC (13) Cl.** **08-06**

(52) **U.S. Cl.**
USPC **D8/315**

(58) **Field of Classification Search**
USPC D8/316, 315, 317, 319, 320, 321, 331,
D8/337, 338, 341; D28/41, 42
CPC . Y10T 16/498; Y10T 16/476; Y10T 16/4644;
Y10T 16/513; Y10T 16/509
See application file for complete search history.

(56) **References Cited**

U.S. PATENT DOCUMENTS

D332,905 S *	2/1993	Dannenberg	D8/321
D377,596 S *	1/1997	Simon	D8/315
D384,569 S *	10/1997	Simon	D8/305
D631,270 S *	1/2011	O'Brien	D6/519
D631,272 S *	1/2011	O'Brien	D6/533

D631,273 S *	1/2011	O'Brien	D6/524
D676,946 S *	2/2013	O'Brien	D23/304
D679,925 S *	4/2013	O'Brien	D6/519

* cited by examiner

Primary Examiner — Keli L Hill

Assistant Examiner — Harold E Blackwell, II

(57) **CLAIM**

The ornamental design for a door handle, as shown and described.

DESCRIPTION

FIG. 1 is a top, front and right side perspective view of a door handle showing my new design;
FIG. 2 is a front view thereof;
FIG. 3 is a rear view thereof;
FIG. 4 is a left side view thereof;
FIG. 5 is a right side view thereof;
FIG. 6 is a top view thereof;
FIG. 7 is a bottom view thereof; and,
FIG. 8 is an enlarged view of the encircled portion 8 in FIG. 1.

The broken lines in the drawings illustrate portions of the door handle or environmental subject matter which form no part of the claimed design. The dot dash broken lines surrounding the detail areas in FIG. 1 denote the boundaries of the detail areas and form no part of the claim design.

1 Claim, 8 Drawing Sheets

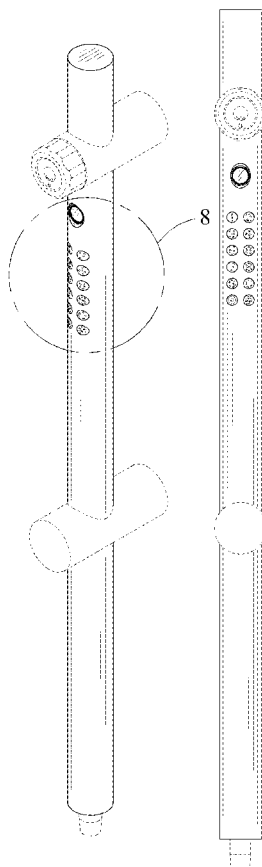

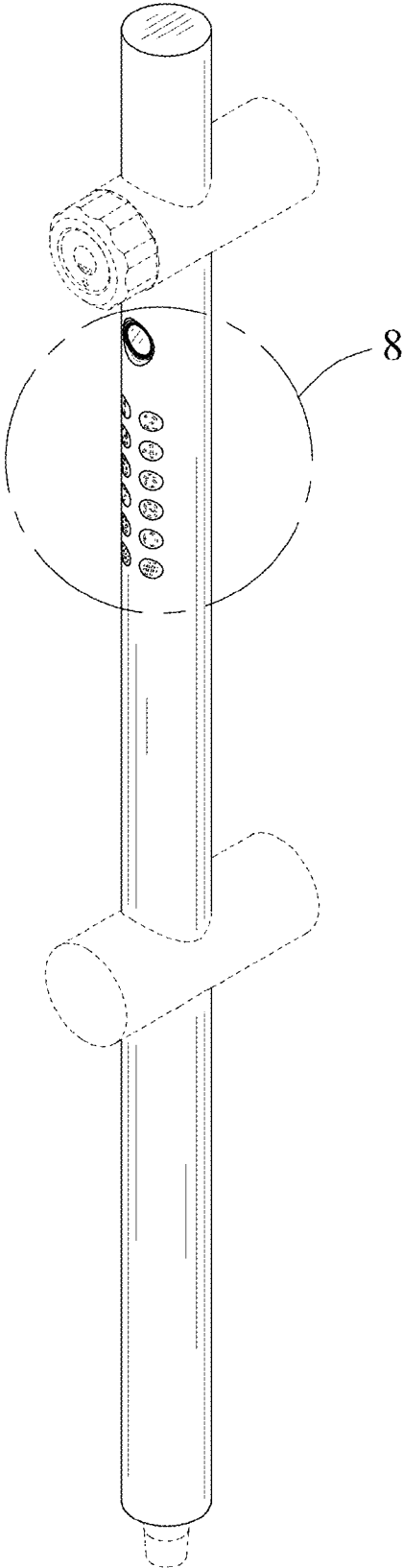

FIG. 1

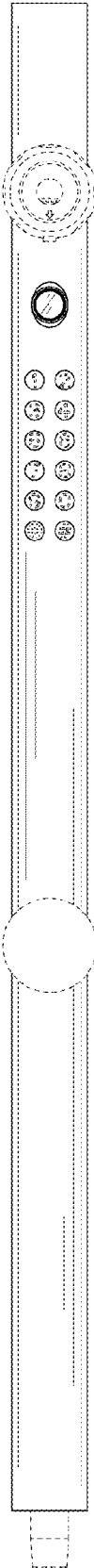

FIG. 2

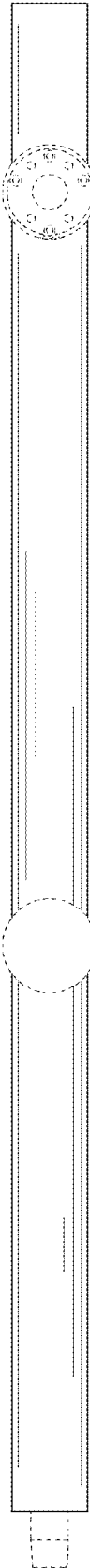

FIG. 3

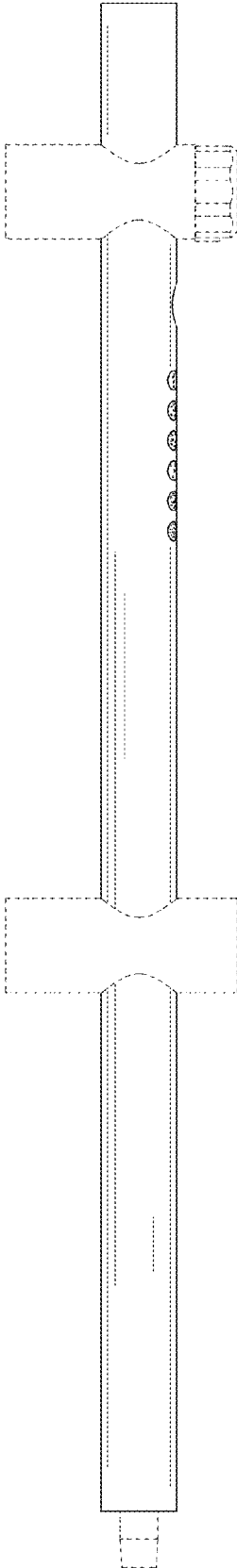

FIG. 4

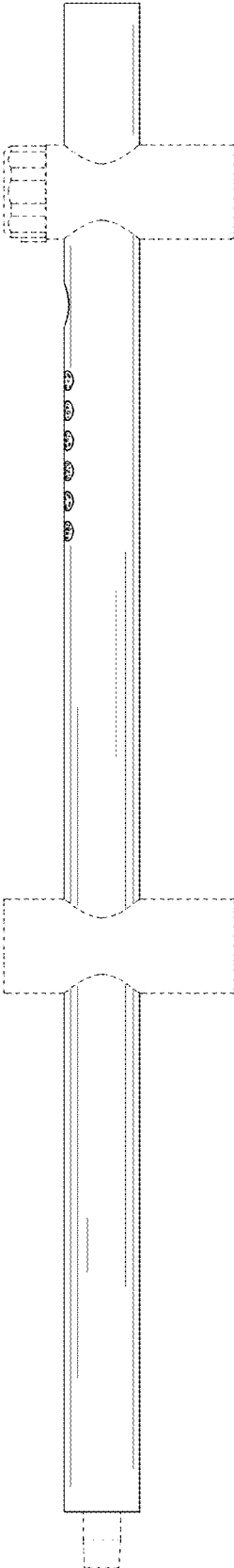

FIG. 5

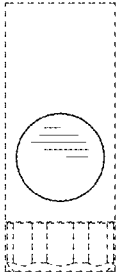

FIG. 6

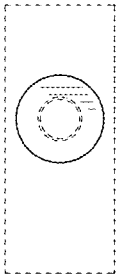

FIG. 7

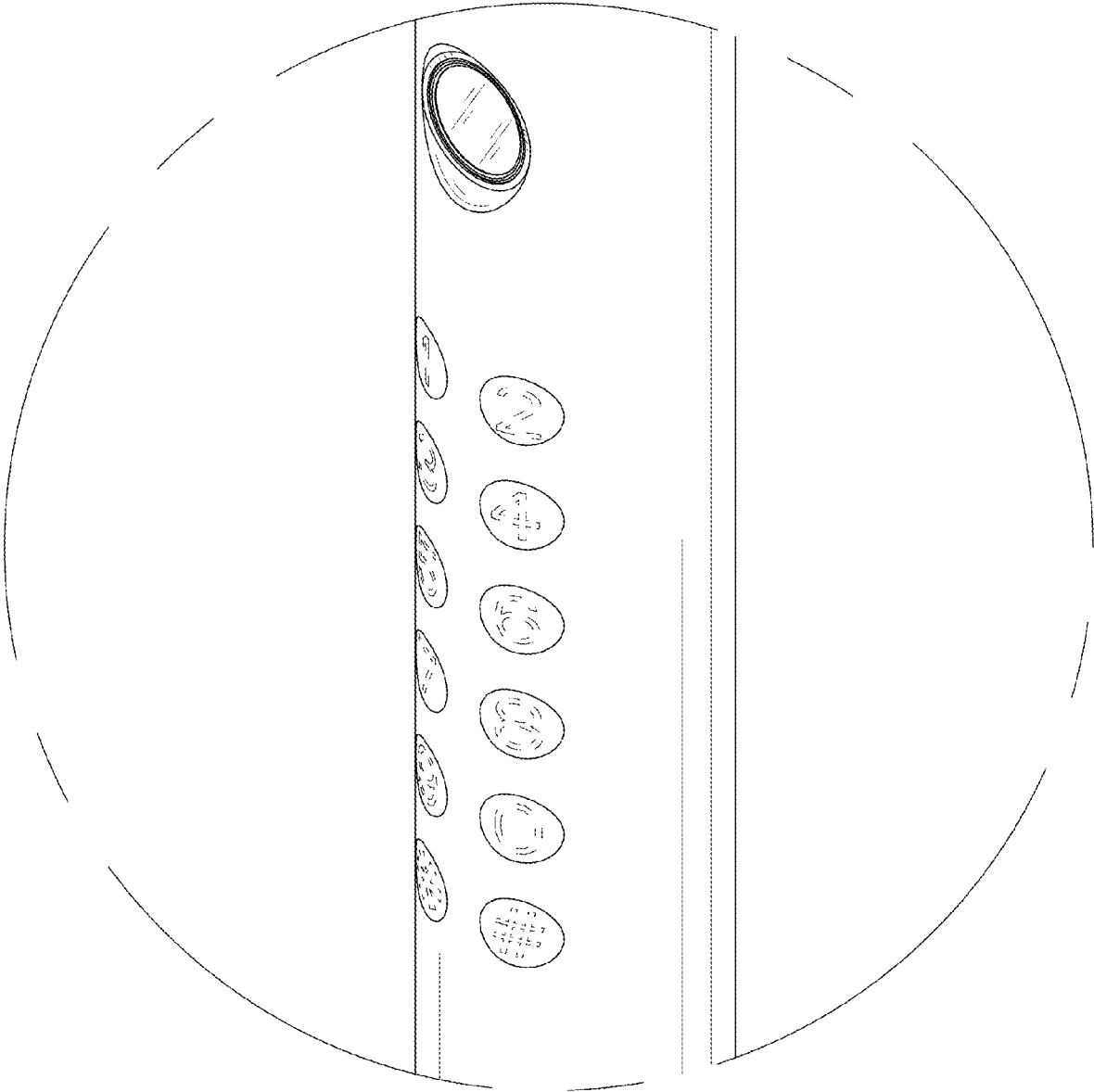

FIG. 8