

US00D549779S

(12) **United States Design Patent**
Shimizu

(10) **Patent No.:** **US D549,779 S**

(45) **Date of Patent:** **** Aug. 28, 2007**

(54) **GRIP FOR A WRITING INSTRUMENT**

(75) Inventor: **Kazuhisa Shimizu**, Tokyo (JP)

(73) Assignee: **Pentel Kabushiki Kaisha** (JP)

(**) Term: **14 Years**

(21) Appl. No.: **29/252,955**

(22) Filed: **Jan. 31, 2006**

(30) **Foreign Application Priority Data**

Aug. 5, 2005 (JP) 2005-022786

(51) **LOC (8) Cl.** **19-06**

(52) **U.S. Cl.** **D19/55**

(58) **Field of Classification Search** D19/35,
D19/36, 41-51, 53-57; 24/11 R, 11 F, 11 P;
401/52, 99, 100, 104, 105, 106, 107, 108,
401/109, 192, 195, 196
See application file for complete search history.

(56) **References Cited**

U.S. PATENT DOCUMENTS

D414,807 S	*	10/1999	Baudino et al.	D19/55
D482,071 S	*	11/2003	Kennedy et al.	D19/55
D496,963 S	*	10/2004	Losel	D19/49
D501,030 S	*	1/2005	Lecce	D19/51
D535,692 S	*	1/2007	Gobbo	D19/49

OTHER PUBLICATIONS

Stilolinea, 247 Trasparente Effetto Gomma Satinata Argento, 2002, 2 pages.*

Solid SchreibenWrite Ecrire, 10.869, p. 10, 2003, 2 pages.*

* cited by examiner

Primary Examiner—Elizabeth A. Albert

(74) *Attorney, Agent, or Firm*—Adams & Wilks

(57) **CLAIM**

The ornamental design for a grip for a writing instrument, as shown and described.

DESCRIPTION

FIG. 1 is a perspective view of a grip for a writing instrument showing my new design;

FIG. 2 is a front view thereof;

FIG. 3 is a bottom view thereof;

FIG. 4 is a rear view thereof;

FIG. 5 is a right side view thereof;

FIG. 6 is a left side view thereof; and,

FIG. 7 is another perspective view thereof, shown in a state of use.

The broken lines showing a pen in FIG. 7 are included for the purpose of illustrating environment and form no part of the claimed design.

1 Claim, 1 Drawing Sheet

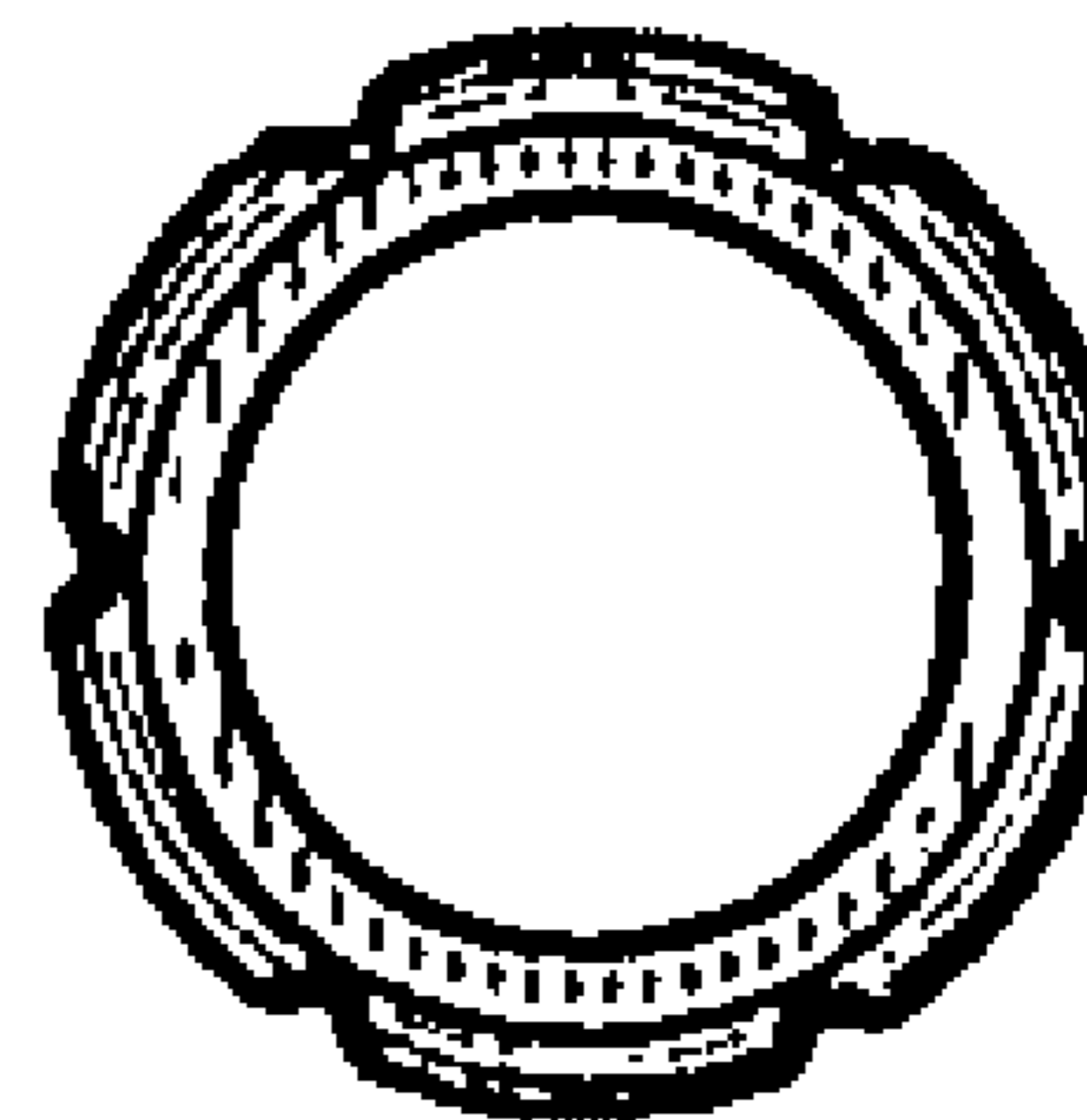
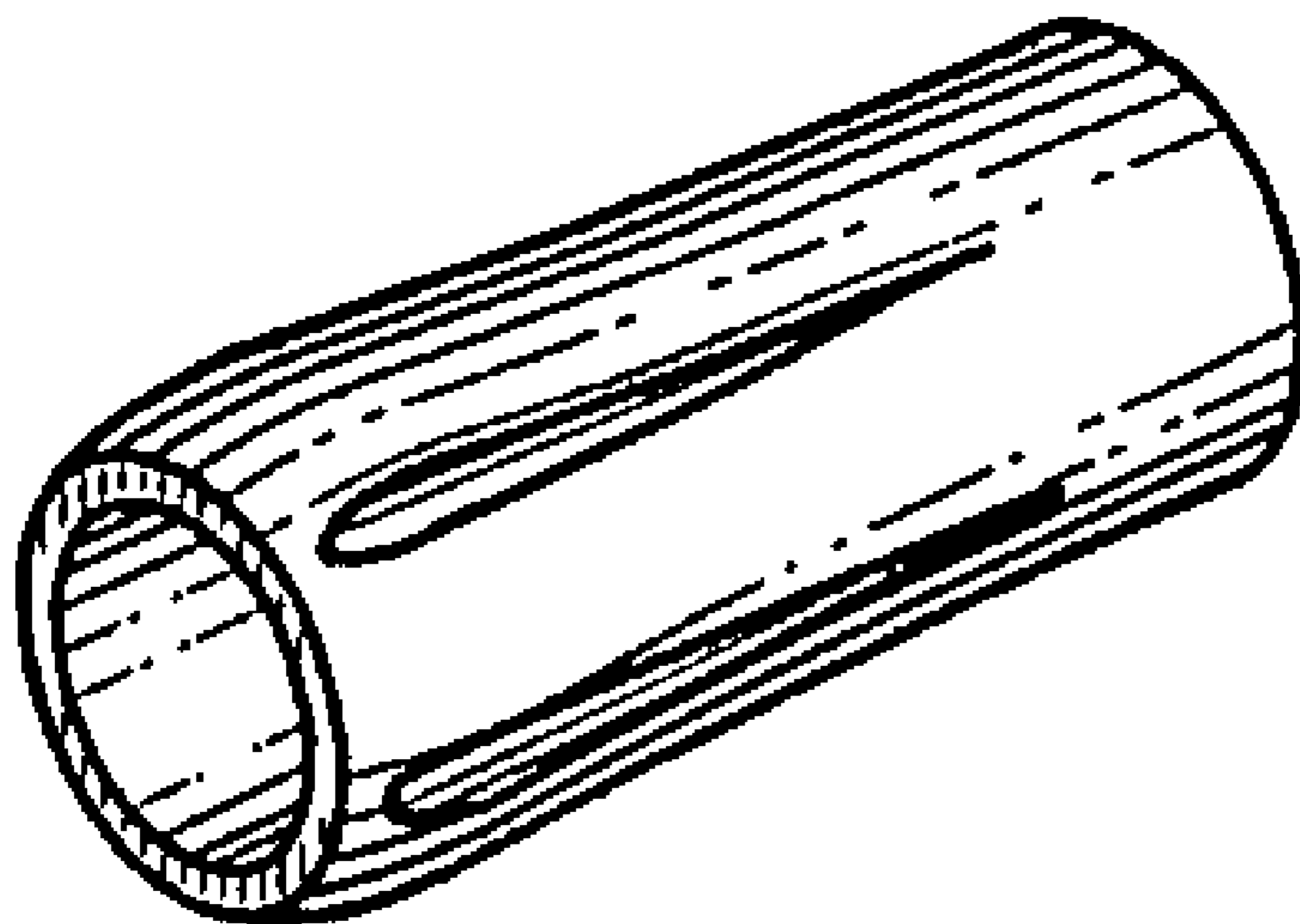

FIG. 1

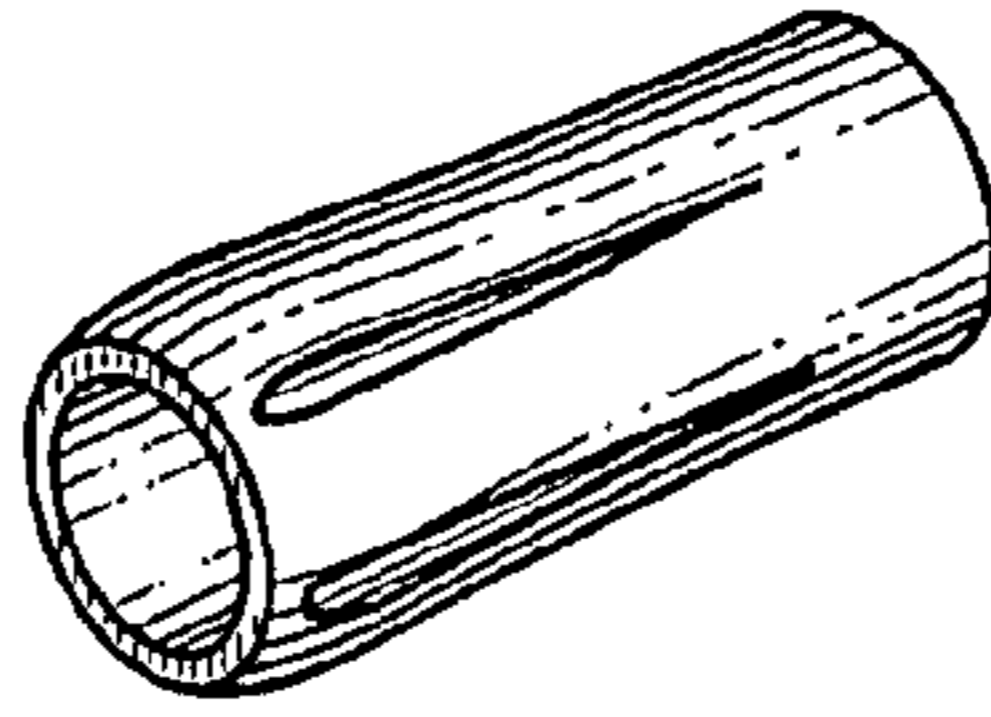

FIG. 2

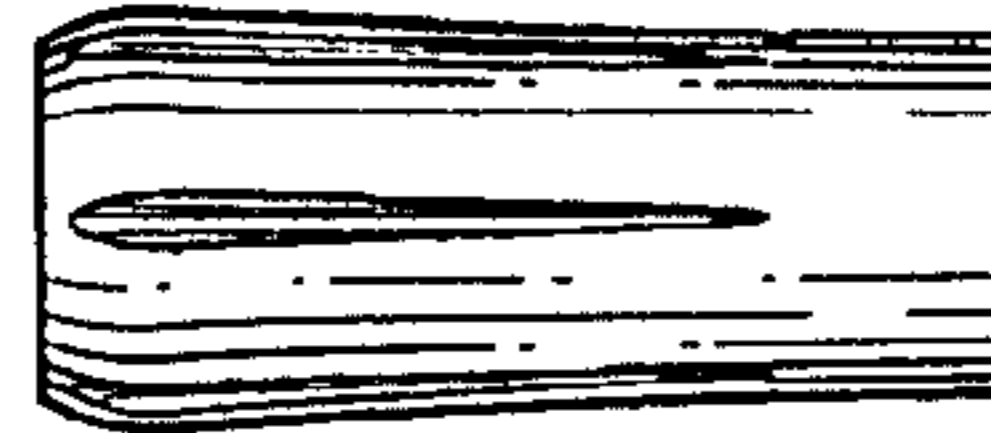

FIG. 3

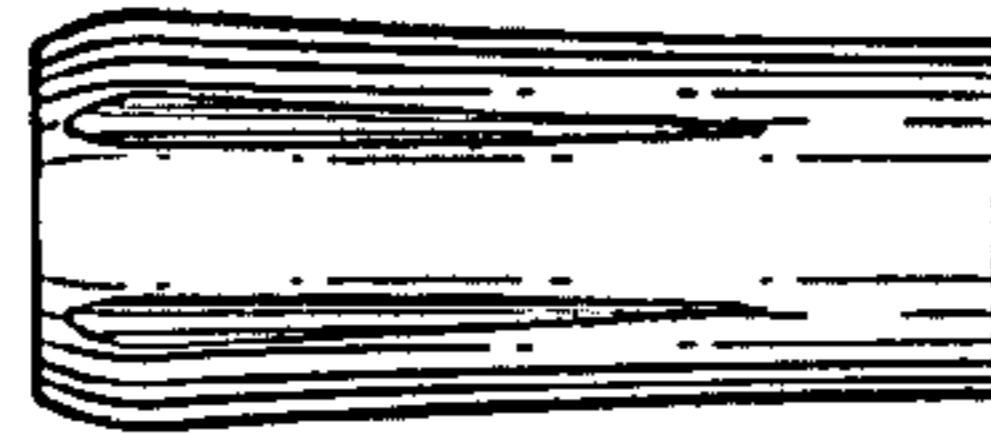

FIG. 4

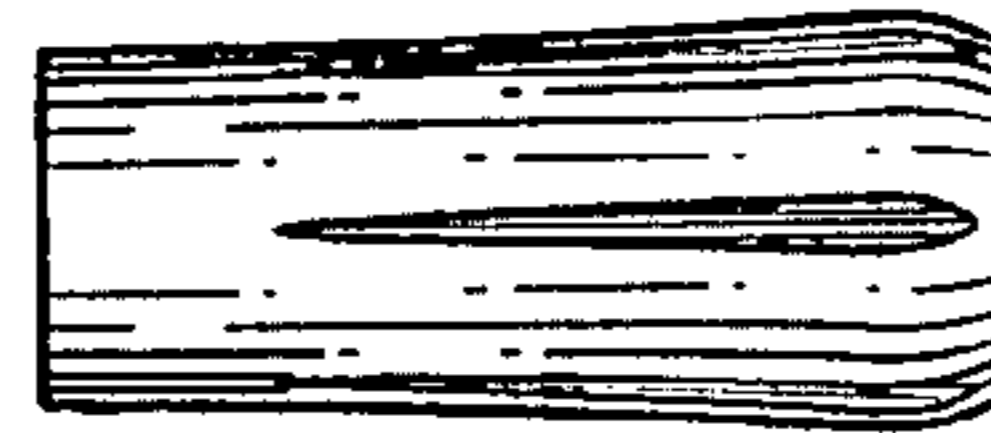

FIG. 5

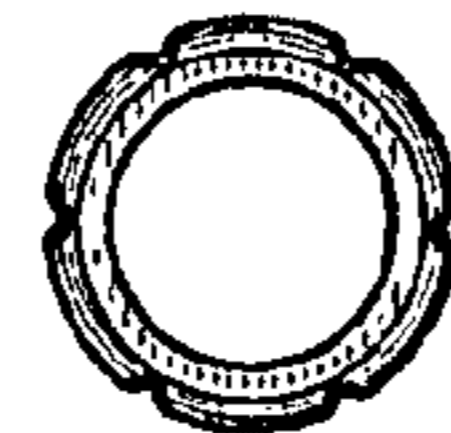

FIG. 6

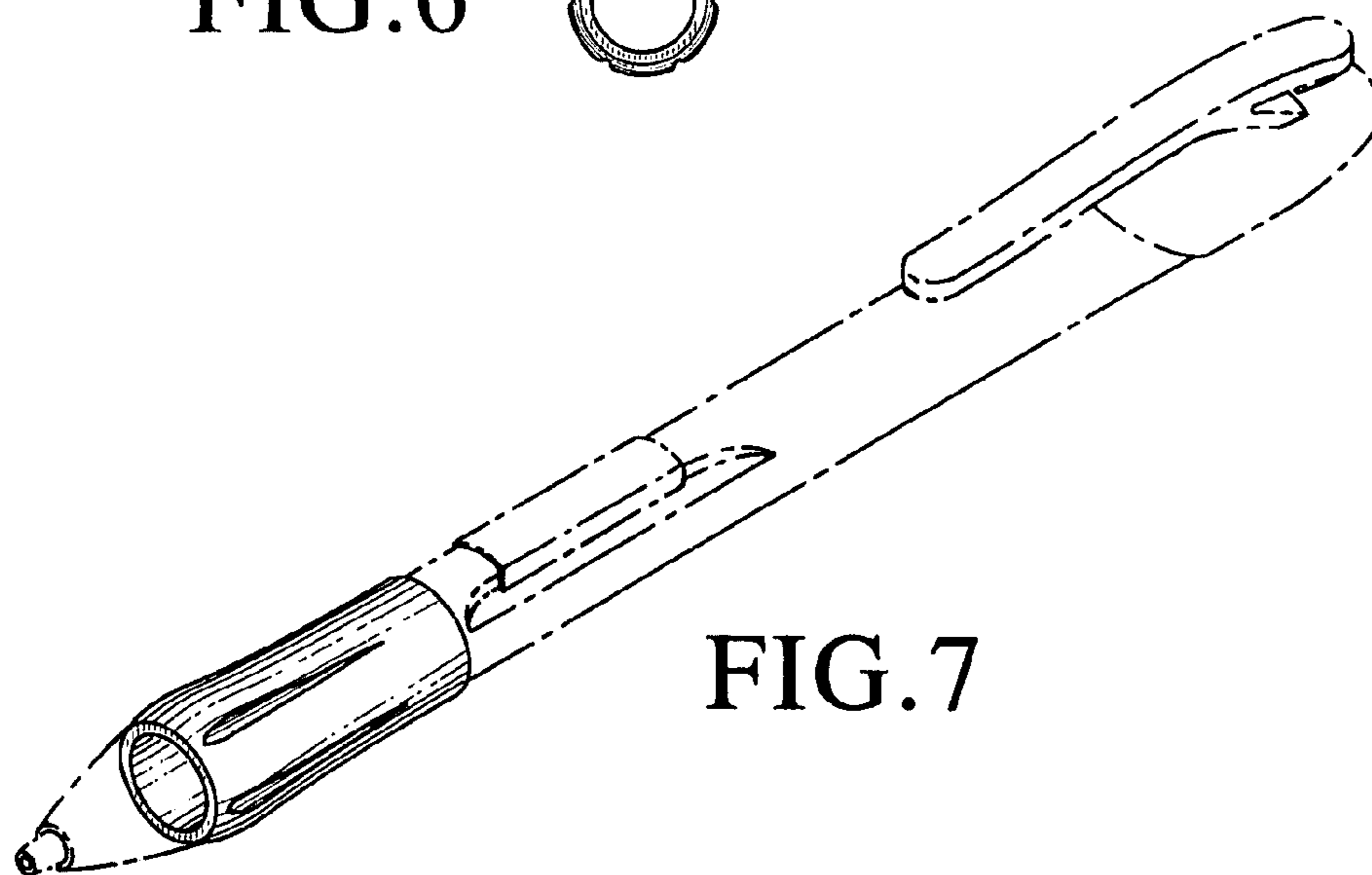
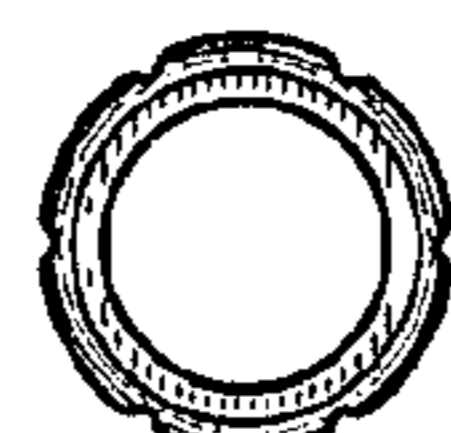

FIG. 7