



US00D802154S

(12) **United States Design Patent**
Ceccarelli

(10) **Patent No.:** **US D802,154 S**

(45) **Date of Patent:** **** Nov. 7, 2017**

- (54) **KNEE WRAP**
- (71) Applicant: **Brian J. Ceccarelli**, Xenia, OH (US)
- (72) Inventor: **Brian J. Ceccarelli**, Xenia, OH (US)
- (**) Term: **15 Years**

8,784,349 B1 * 7/2014 Nelson A61F 5/0109
602/23
D716,954 S * 11/2014 Forbes D24/190
D716,956 S * 11/2014 Ortega D24/190
9,044,053 B1 6/2015 Osatchuck
(Continued)

- (21) Appl. No.: **29/554,044**
- (22) Filed: **Feb. 8, 2016**
- (51) **LOC (10) Cl.** **24-01**
- (52) **U.S. Cl.**
USPC **D24/190**
- (58) **Field of Classification Search**
USPC D24/188-192; D29/120.1, 121.1
CPC A61F 5/0109; A61F 2005/0176; A61F
5/0106; A61F 5/0123; A61F 13/101;
A61F 5/0118; A61F 13/08; A61F 13/06;
A61F 5/0125; A41D 13/065; A41D
13/08; A41D 13/0568
See application file for complete search history.

OTHER PUBLICATIONS

Product Information featuring "FootSmart Nighttime Osteoarthritis Knee Sleeve", <http://www.amazon.com/FootSmart-Nighttime-Osteoarthritis-Knee-Sleeve/dp/B000OFBS...> (at least as early as Nov. 30, 2012).

(Continued)

Primary Examiner — George D Kirschbaum
Assistant Examiner — Jennifer Watkins
(74) *Attorney, Agent, or Firm* — Thompson Hine LLP

(57) **CLAIM**

The ornamental design for a knee wrap, as shown and described.

DESCRIPTION

FIG. 1 is a perspective view of a knee wrap showing my new design;
FIG. 2 is a front elevation view thereof;
FIG. 3 is a back elevation view thereof;
FIG. 4 is a left side elevation view thereof;
FIG. 5 is a right side elevation view thereof;
FIG. 6 is a top view thereof;
FIG. 7 is a bottom view thereof; and,
FIG. 8 is a perspective view thereof with the pocket thereof in an open position.

The broken lines showing stitches on claimed surfaces is for the purpose of illustrating portions of the article and form no part of the claim. The broken lines in FIGS. 1 and 6-8, with respect to the inseam padding, illustrate environmental subject matter and form no part of the claim.

1 Claim, 7 Drawing Sheets

(56) **References Cited**

U.S. PATENT DOCUMENTS

3,322,118	A *	5/1967	Sotherlin	A61F 13/069 128/881
4,905,715	A	3/1990	Johnson		
D333,403	S	2/1993	Perrone		
5,377,693	A	1/1995	Loper et al.		
D366,801	S	2/1996	Gray		
D393,073	S	3/1998	Downing et al.		
D405,558	S	2/1999	Campisi et al.		
D439,342	S	3/2001	Seip, Jr.		
D448,084	S *	9/2001	Hopwood	D24/190
6,327,713	B1	12/2001	Gomez		
6,745,406	B2	6/2004	Ruane		
D501,927	S *	2/2005	McCormick	D24/190
7,296,313	B2	11/2007	Hense		
D663,563	S	7/2012	Szeto		
D683,859	S *	6/2013	Forbes	D24/190
D703,824	S *	4/2014	Ferguson, Jr.	D21/683

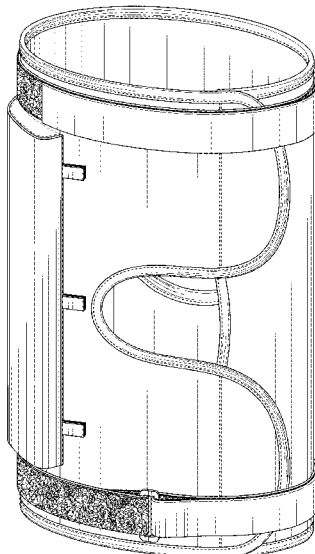

(56)

References Cited

U.S. PATENT DOCUMENTS

D750,790 S * 3/2016 Ortega D24/190
2003/0135917 A1 7/2003 Ruane
2004/0225245 A1* 11/2004 Nelson A61F 5/0123
602/26
2005/0038367 A1* 2/2005 McCormick A61F 5/0106
602/26

OTHER PUBLICATIONS

Product Information featuring “DonJoy Deluxe Hinged Knee Brace,
Drytex Sleeve, Open Popliteal, Large”, [http://www.amazon.com/
DonJoy-Deluxe-Hinged-Drytex-Popliteal/dp/BOOP3D1HWE](http://www.amazon.com/DonJoy-Deluxe-Hinged-Drytex-Popliteal/dp/BOOP3D1HWE)
(least as early as Apr. 9, 2015).

* cited by examiner

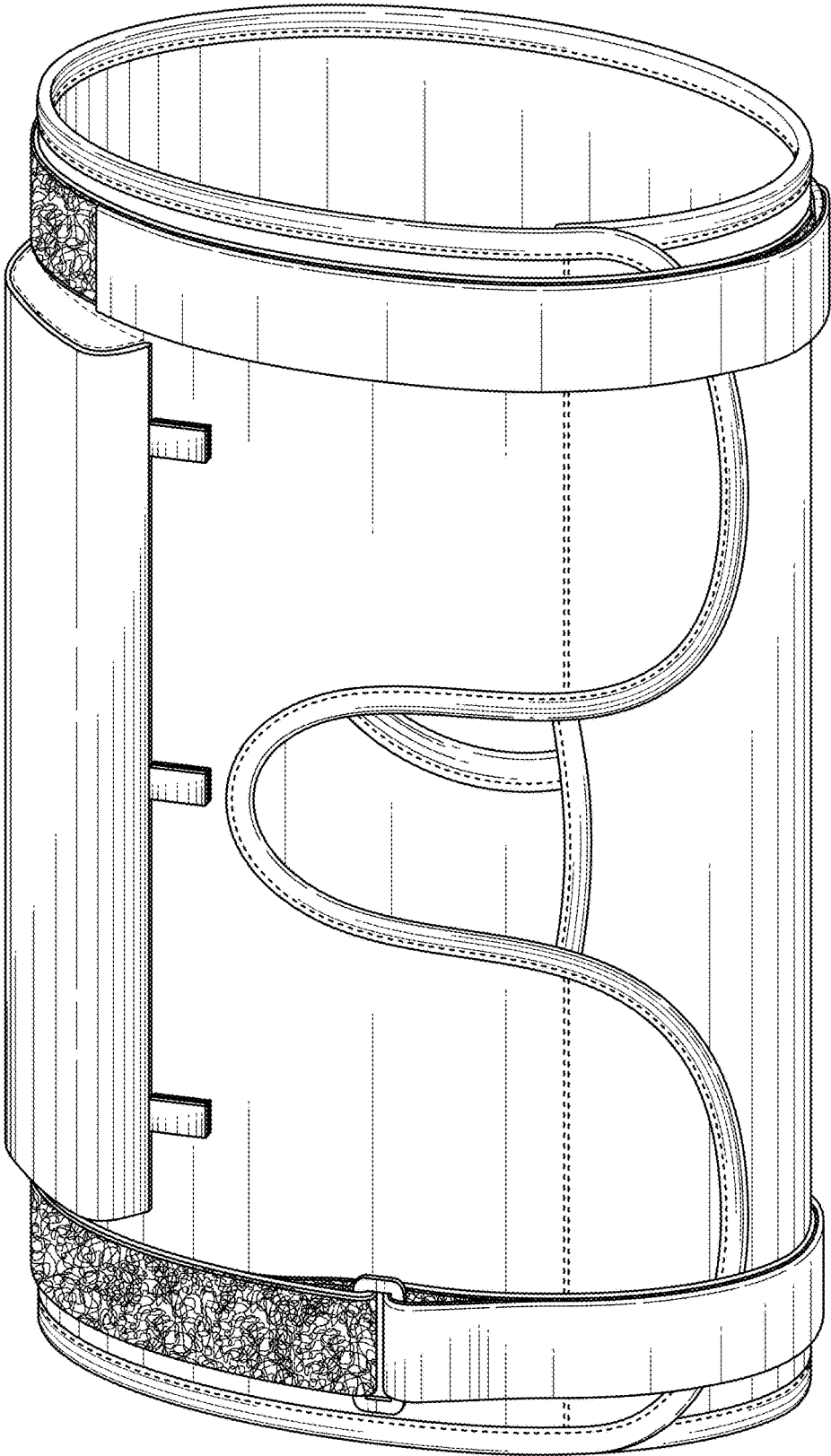

FIG. 1

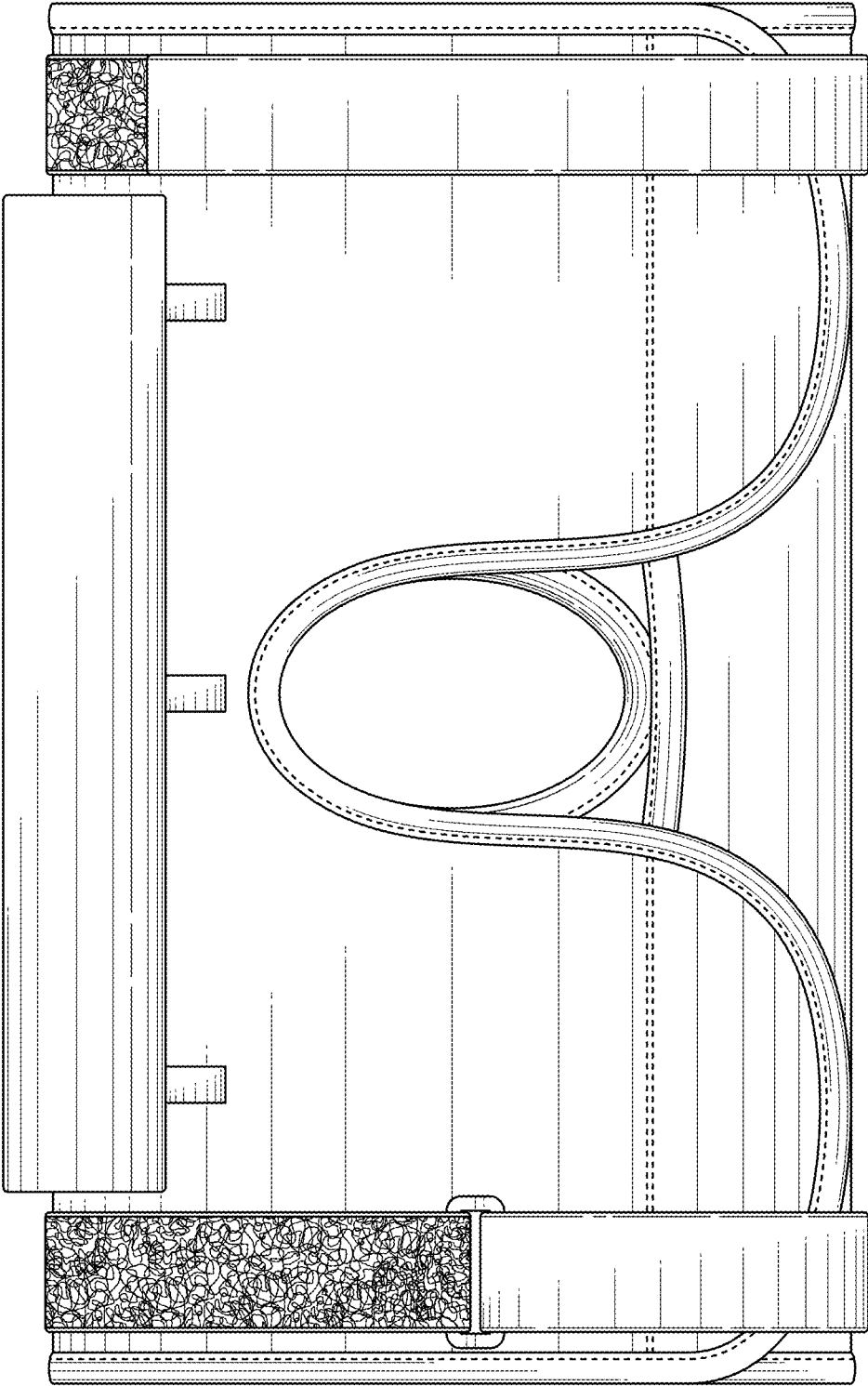

FIG. 2

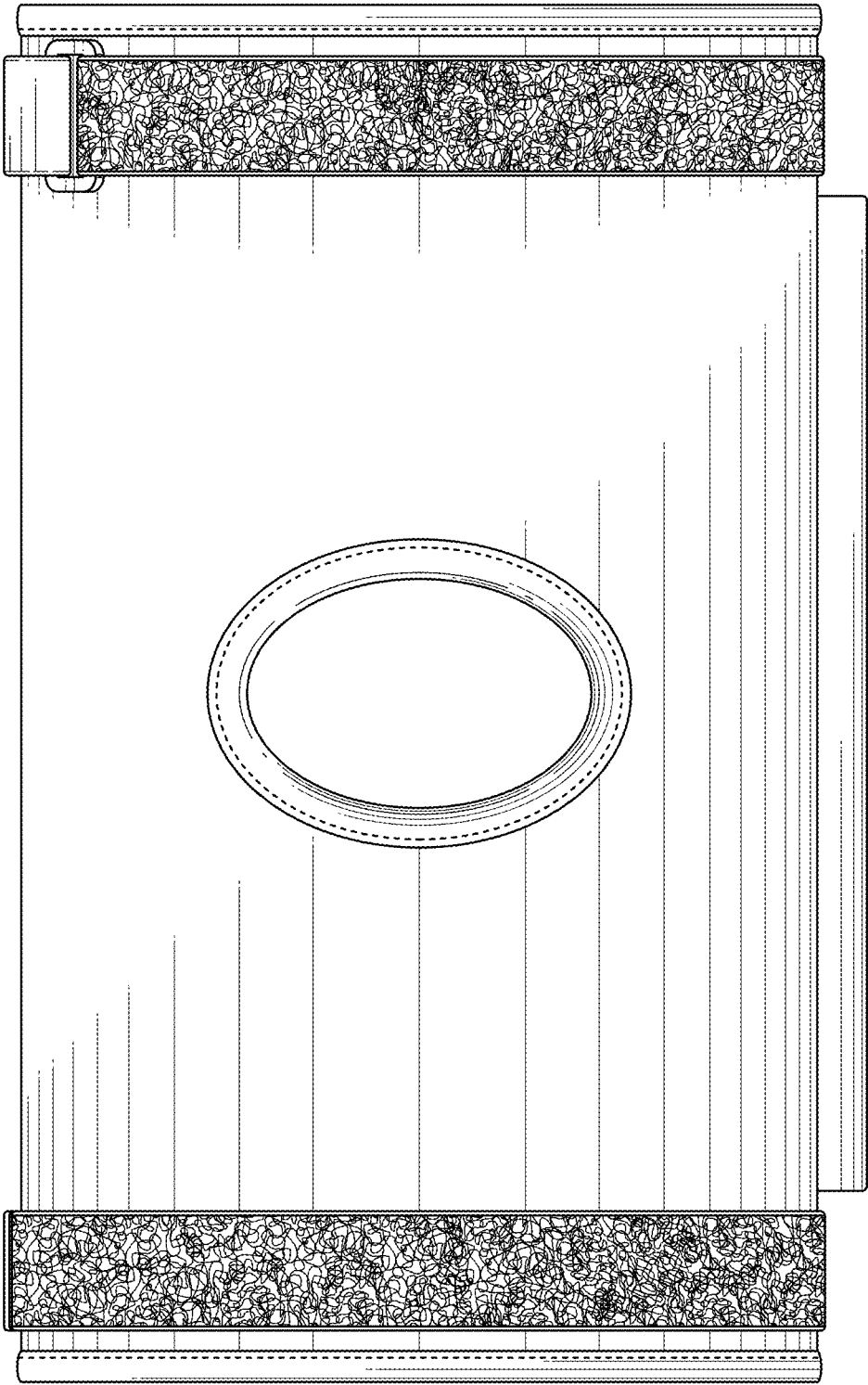

FIG. 3

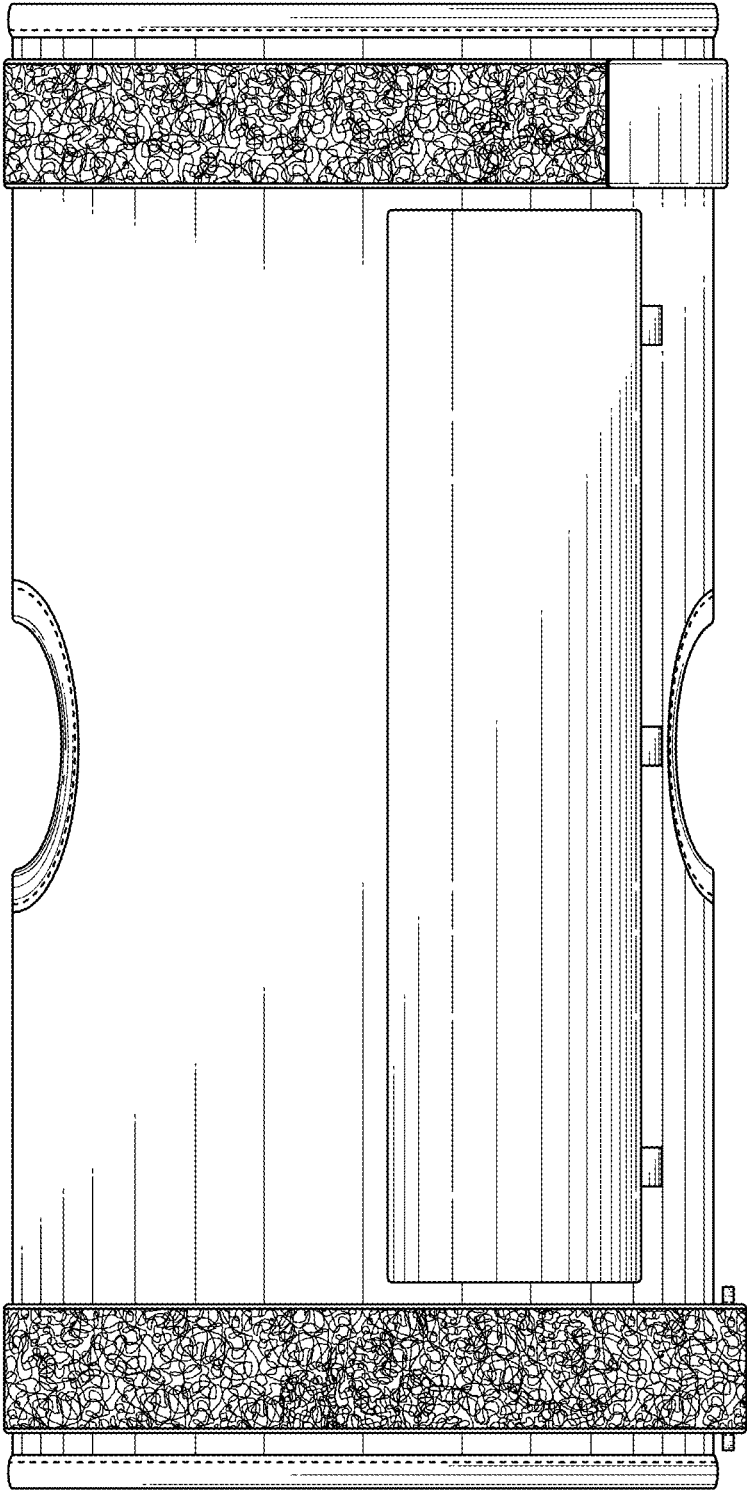

FIG. 4

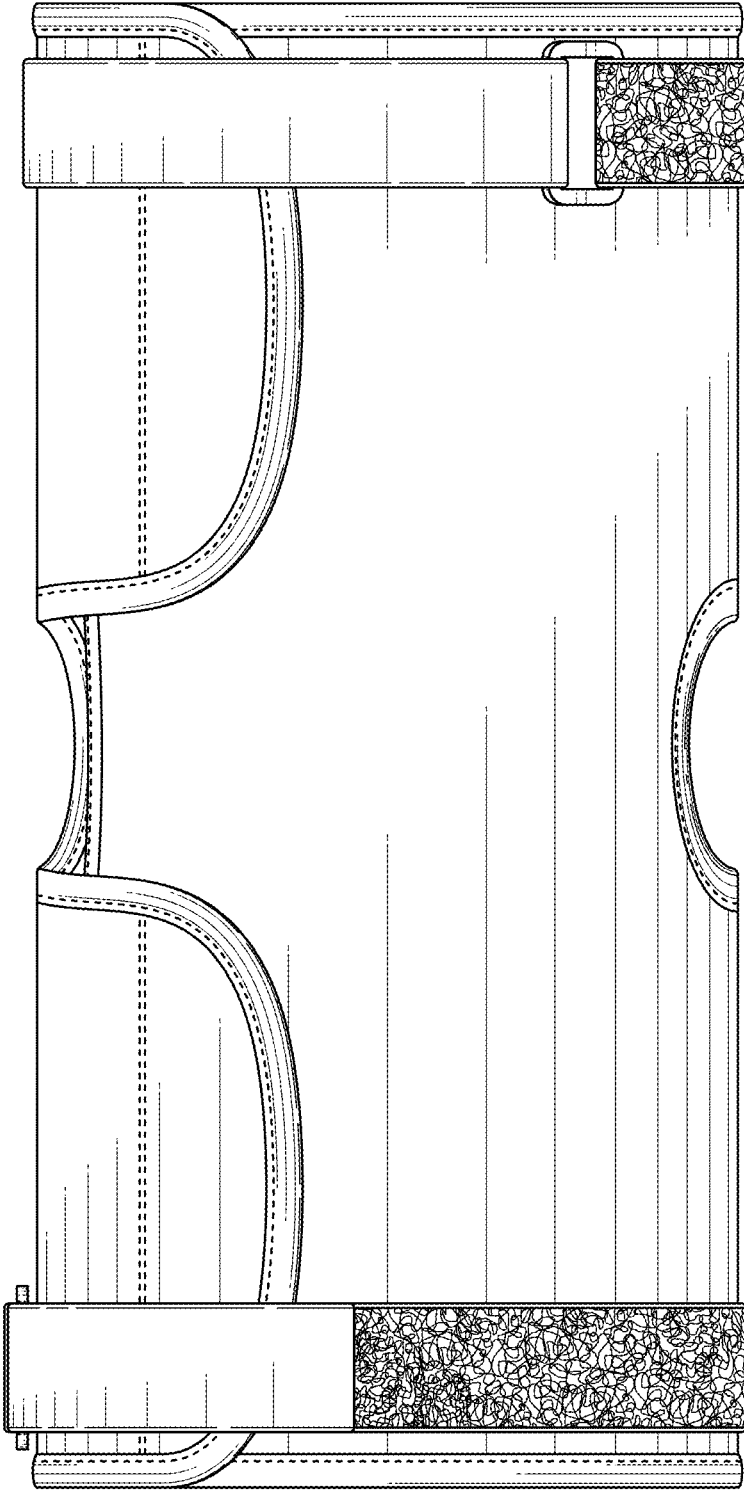

FIG. 5

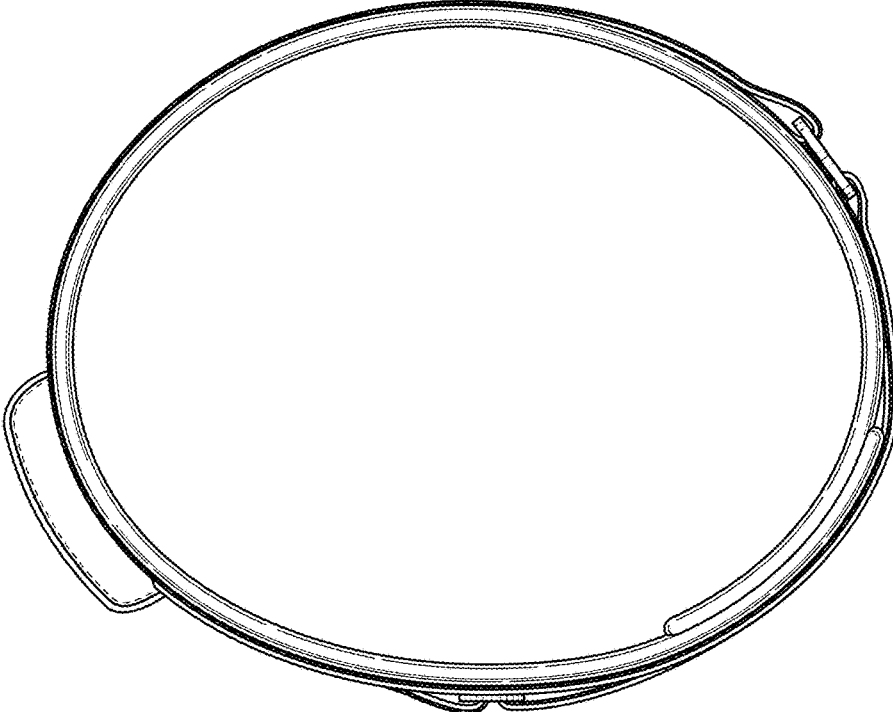

FIG. 6

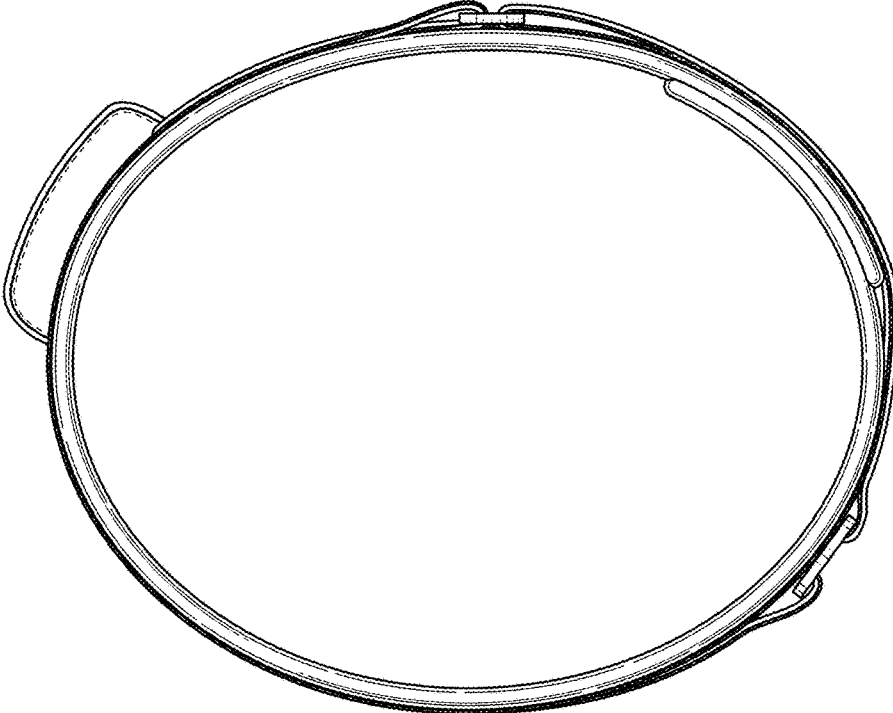

FIG. 7

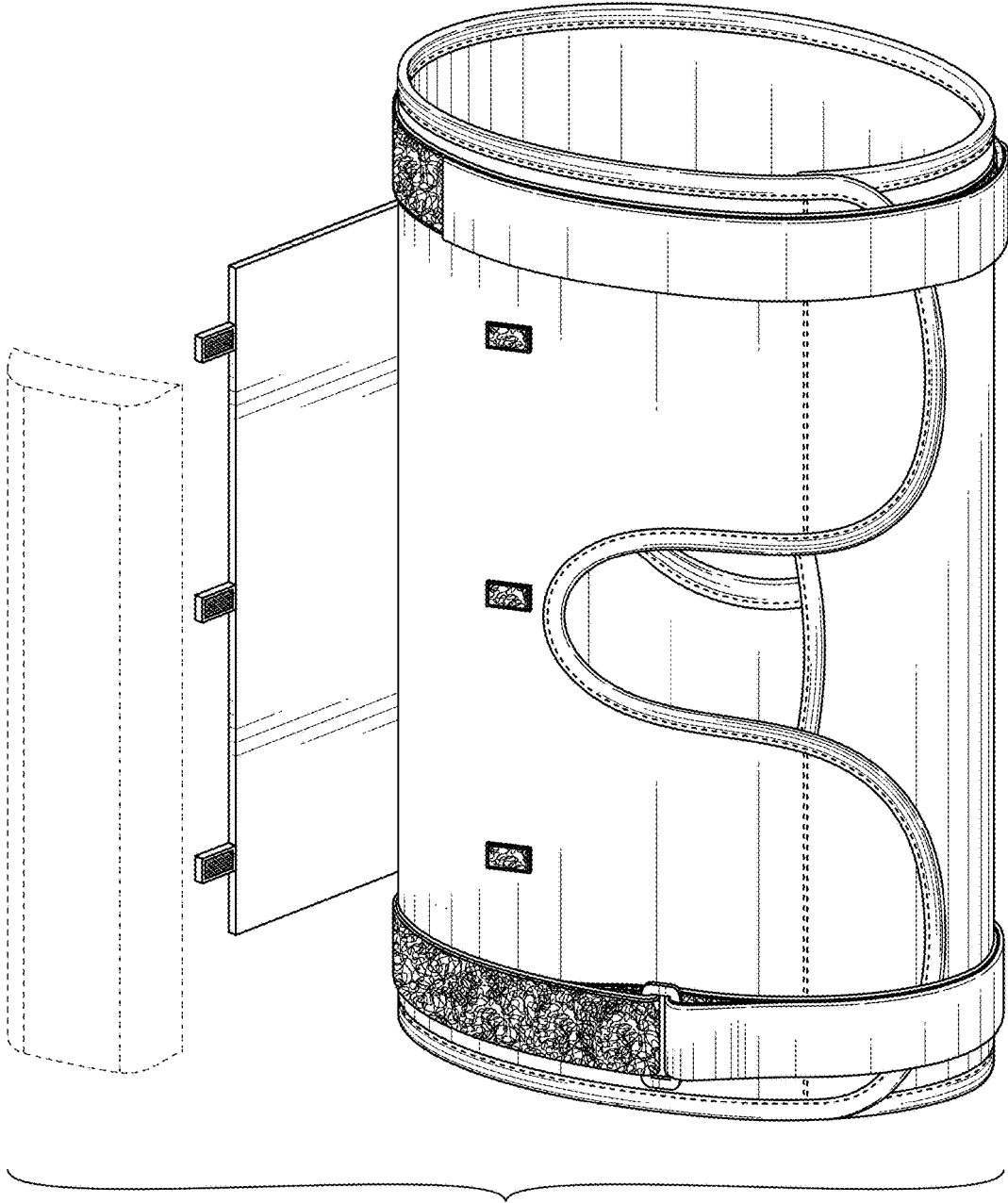

FIG. 8