



(12) **United States Design Patent**
Burgett et al.

(10) **Patent No.:** **US D717,274 S**
(45) **Date of Patent:** **** Nov. 11, 2014**

(54) **CINCH FOR EARBUD AND EARPHONE CORDS**

(71) Applicants: **Seth D Burgett**, Glen Carbon, IL (US);
Effrosini A. Karayiannis, Saint Louis, MO (US); **Aaron Gorga**, Saint Louis, MO (US)

(72) Inventors: **Seth D Burgett**, Glen Carbon, IL (US);
Effrosini A. Karayiannis, Saint Louis, MO (US); **Aaron Gorga**, Saint Louis, MO (US)

(73) Assignee: **Verto Medical Solutions, LLC**, St. Louis, MO (US)

(**) Term: **14 Years**

(21) Appl. No.: **29/466,561**

(22) Filed: **Sep. 9, 2013**

(51) **LOC (10) Cl.** **14-01**

(52) **U.S. Cl.**
USPC **D14/205**

(58) **Field of Classification Search**
CPC H04R 1/1033
USPC D14/205, 223; D8/356; D13/133, 154;
181/129, 130, 135; 379/430, 431;
381/380, 381, 384, 74; 24/122.6,
24/115 H, 712.2

See application file for complete search history.

(56) **References Cited**

U.S. PATENT DOCUMENTS

1,527,802 A	2/1925	Huggins	
1,893,474 A	1/1933	Lieber	
2,148,477 A	2/1939	Koch	
2,325,590 A	7/1943	Carlisle et al.	
2,344,023 A	3/1944	Carlisle et al.	
2,430,229 A	11/1947	Kelsey	
2,549,629 A	4/1951	Nelson	
2,641,327 A *	6/1953	Balmer	181/129
3,047,089 A	7/1962	Zwislocki	

D196,654 S	10/1963	Van Den Berg	
3,527,487 A *	9/1970	Payne	403/210
3,539,031 A	11/1970	Scanlon	
D242,810 S	12/1976	Rynearson	
4,069,400 A	1/1978	Johanson et al.	
D249,508 S	9/1978	Coughlin et al.	
D262,617 S *	1/1982	Shumate	D13/156
D266,590 S	10/1982	Bennett	
4,375,016 A	2/1983	Harada	
D273,707 S	5/1984	McCall	
D287,280 S	12/1986	Topholm	
D287,764 S	1/1987	Topholm	
D287,765 S	1/1987	Topholm	
D288,093 S	2/1987	Fujiyama et al.	
4,646,872 A *	3/1987	Kamon et al.	181/129
4,972,492 A	11/1990	Tanaka et al.	
5,146,051 A	9/1992	Hermann	
D340,286 S	10/1993	Seo	
5,412,736 A	5/1995	Keliiliki	
D363,487 S	10/1995	Thurnau	
D368,309 S	3/1996	Narisawa	
5,625,171 A	4/1997	Marshall	
5,659,156 A	8/1997	Mauney et al.	

(Continued)

Primary Examiner — Paula Greene

(74) *Attorney, Agent, or Firm* — Harness, Dickey & Pierce, P.L.C.

(57) **CLAIM**

The ornamental design for a cinch for earbud and earphone cords, as shown and described.

DESCRIPTION

FIG. 1 is a perspective view of a cinch for earbud and earphone cords in accordance with our new design; FIG. 2 is a front elevation view thereof; FIG. 3 is a rear elevation view thereof; FIG. 4 is a top plan view thereof; FIG. 5 is a bottom plan view thereof; FIG. 6 is a left side elevation view thereof; and, FIG. 7 is a right side elevation view thereof. The dashed lines in the drawings are for illustrative purposes only and form no part of the claimed design.

1 Claim, 4 Drawing Sheets

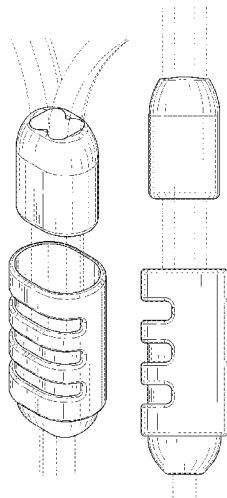

(56)

References Cited

U.S. PATENT DOCUMENTS

D388,093 S	12/1997	Frengley	
5,712,453 A	1/1998	Bungardt et al.	
D391,576 S	3/1998	Mullin et al.	
D392,979 S *	3/1998	Inukai	D14/228
D405,528 S	2/1999	Shennib et al.	
6,363,158 B1	3/2002	Lu	
6,396,935 B1	5/2002	Makkonen	
6,427,018 B1	7/2002	Keliiliki	
D470,479 S	2/2003	Skulley et al.	
D471,537 S	3/2003	Ham	
D474,178 S	5/2003	Eroma	
D478,991 S	8/2003	Dyer et al.	
D479,226 S	9/2003	Beauregard, Jr.	
D480,073 S	9/2003	Jensen et al.	
D480,711 S	10/2003	Kuan	
6,688,421 B2	2/2004	Dyer et al.	
6,690,807 B1	2/2004	Meyer	
D497,613 S	10/2004	Gwee	
D501,196 S	1/2005	Dyer et al.	
D504,673 S	5/2005	Dyer et al.	
D505,132 S	5/2005	Linville et al.	
D506,462 S	6/2005	Han et al.	
D514,094 S	1/2006	Griffin	
D519,985 S	5/2006	Wikel et al.	
7,106,877 B1	9/2006	Linville	
D532,110 S	11/2006	Bailey et al.	
D543,968 S	6/2007	Wong	
D574,361 S	8/2008	Sasaki	
D575,772 S	8/2008	Schultz et al.	
D578,966 S *	10/2008	Grimm	D13/153
D585,836 S *	2/2009	Lee et al.	D13/154
D585,881 S	2/2009	Nam et al.	
D589,152 S	3/2009	Champkins	
D589,945 S	4/2009	Esses	
D593,077 S	5/2009	Williams et al.	
D593,537 S	6/2009	Arimoto	
D597,069 S	7/2009	Wengreen	
D601,134 S	9/2009	Elabidi et al.	
D603,837 S *	11/2009	Martin	D14/206
D605,628 S *	12/2009	Ando	D14/205
D618,218 S	6/2010	Burgett et al.	
D618,219 S	6/2010	Burgett et al.	
D622,697 S *	8/2010	Kolton	D14/205
D622,705 S	8/2010	Fahrendorff et al.	
D624,902 S *	10/2010	Kolton	D14/205
D639,787 S	6/2011	Quek	
D643,404 S *	8/2011	Lee et al.	D14/205
D643,414 S *	8/2011	Lee et al.	D14/223
D643,418 S	8/2011	Lee et al.	
D645,022 S *	9/2011	Lee et al.	D14/205
D645,455 S	9/2011	Manhard et al.	
D648,316 S *	11/2011	Lee et al.	D14/205
D651,180 S *	12/2011	Lee et al.	D13/154
D652,817 S *	1/2012	Lee et al.	D14/205
D654,057 S	2/2012	Burgett et al.	
8,111,863 B2	2/2012	Oliveira et al.	
8,111,864 B2	2/2012	Oliveira et al.	
D669,882 S *	10/2012	Prisciandaro	D14/205
8,290,193 B2 *	10/2012	Pang et al.	381/374
D673,530 S	1/2013	Feng et al.	
8,345,913 B2 *	1/2013	Pang et al.	381/384
D678,868 S	3/2013	Feng et al.	
D685,764 S *	7/2013	Coulter	D14/205
2009/0238395 A1 *	9/2009	Jubelirer et al.	381/370
2010/0027831 A1 *	2/2010	Lee et al.	381/384
2012/0170790 A1 *	7/2012	Pang et al.	381/384
2013/0188804 A1	7/2013	Burgett	

* cited by examiner

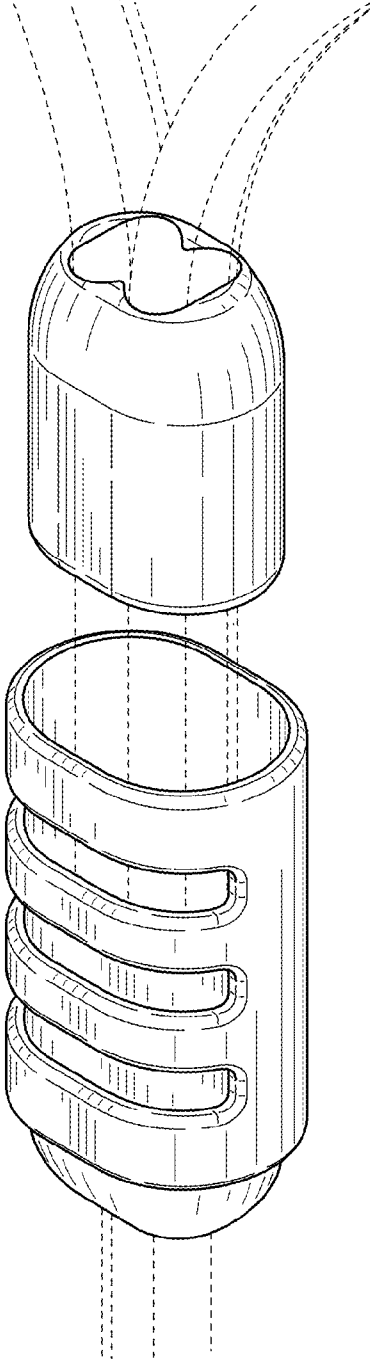

FIG. 1

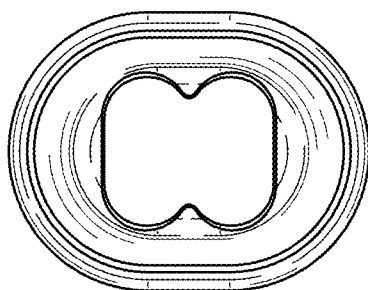

FIG. 2

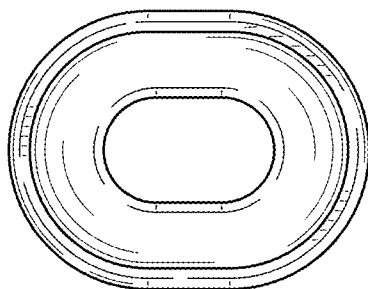

FIG. 3

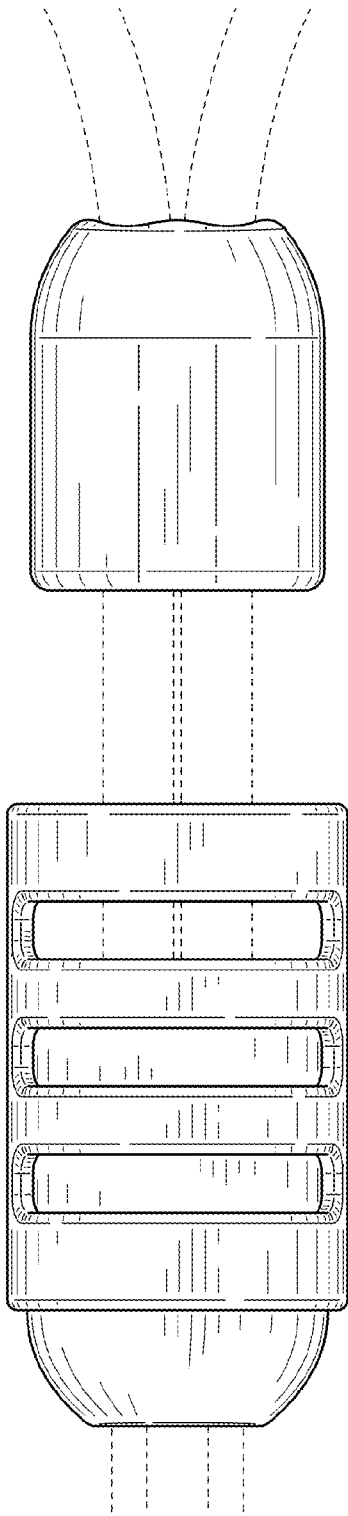

FIG. 4

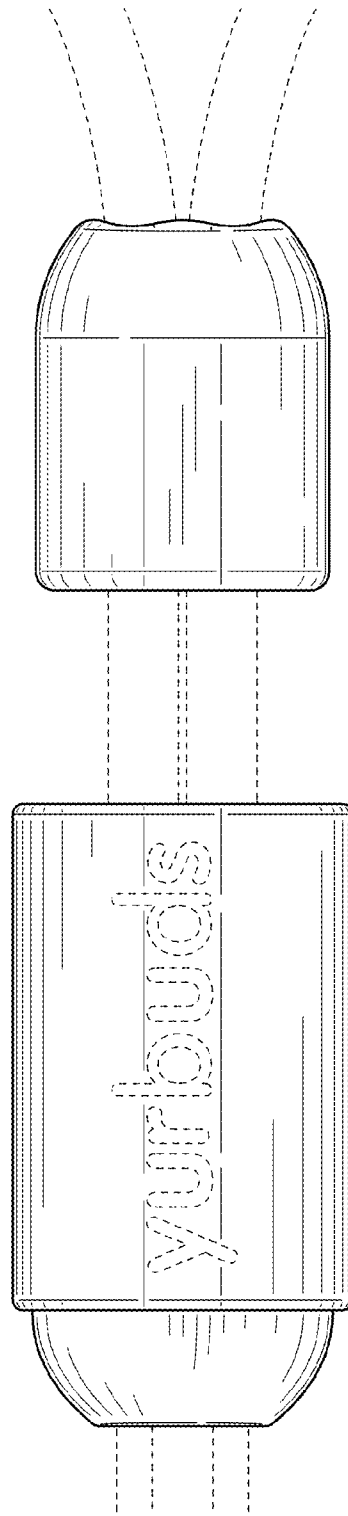

FIG. 5

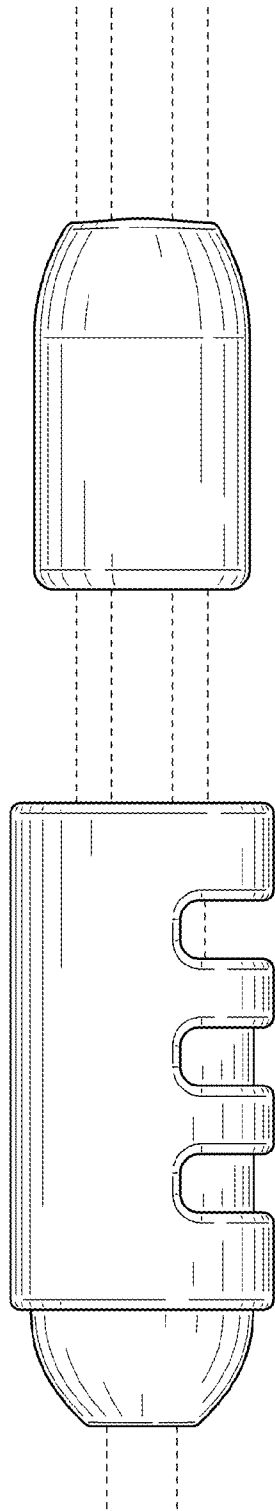

FIG. 6

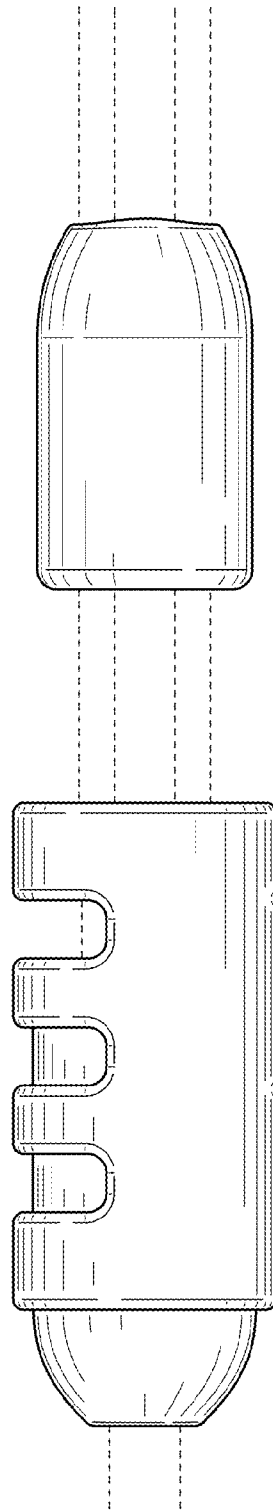

FIG. 7