



(12) **United States Design Patent**
Nguyen et al.

(10) **Patent No.:** **US D750,378 S**
(45) **Date of Patent:** **** Mar. 1, 2016**

(54) **TOOTHBRUSH**

(71) Applicant: **Children Oral Care, LLC**, Buena Park, CA (US)

(72) Inventors: **Huy Kha Nguyen**, Anaheim, CA (US);
Kari Kimiko Nishimura, Northridge, CA (US); **Geoff Carroll**, Los Angeles, CA (US); **Gloria Shen**, Huntington Beach, CA (US)

(73) Assignee: **CHILDREN ORAL CARE, LLC**, Buena Park, CA (US)

(**) Term: **14 Years**

(21) Appl. No.: **29/504,797**

(22) Filed: **Oct. 9, 2014**

(51) **LOC (10) Cl.** **28-03**

(52) **U.S. Cl.**
USPC **D4/101; D4/138**

(58) **Field of Classification Search**
USPC D4/101, 104–113, 138
CPC A46B 3/00; A46B 9/00; A46B 9/02; A46B 9/04; A46B 9/045; A46B 2200/10; A46B 2200/1026; A46B 2200/1046; A46B 2200/1053; A46B 2200/1066; A46B 2200/1073; A46B 2200/108; A46B 2200/1086

See application file for complete search history.

(56) **References Cited**

U.S. PATENT DOCUMENTS

1,860,911	A *	5/1932	Trimble	A46B 11/0027
					15/176.1
5,305,490	A *	4/1994	Lundgren	A46B 5/02
					15/143.1
5,617,884	A *	4/1997	Allison	A46B 5/0095
					132/308
D401,069	S *	11/1998	Lamond	D4/104
D401,413	S *	11/1998	Porter	D4/104
D464,489	S *	10/2002	Emerick	D4/108
D631,255	S *	1/2011	Vilain	D4/100
D658,883	S *	5/2012	Winkler	D4/101
8,534,950	B2 *	9/2013	Sylvester	A46B 11/0024
					401/172
D724,235	S *	3/2015	Kuneyl	D24/215

* cited by examiner

Primary Examiner — Clare E Heflin

(74) *Attorney, Agent, or Firm* — Snell & Wilmer LLP

(57) **CLAIM**

We claim the ornamental design for a toothbrush, as shown and described.

DESCRIPTION

FIG. 1 is a front view of the toothbrush showing our new design; FIG. 2 is a right side view of the toothbrush; FIG. 3 is a left side view of the toothbrush; FIG. 4 is a top view of the toothbrush; FIG. 5 is a bottom view of the toothbrush; FIG. 6 is a rear view of the toothbrush; and, FIG. 7 is a front perspective view of the toothbrush. The broken lines shown in the figures represent portions of the toothbrush that form no part of the claimed design.

1 Claim, 7 Drawing Sheets

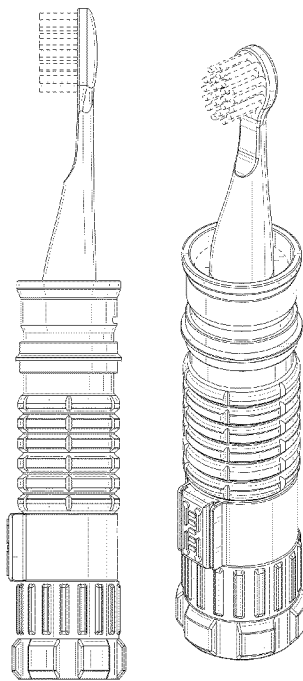

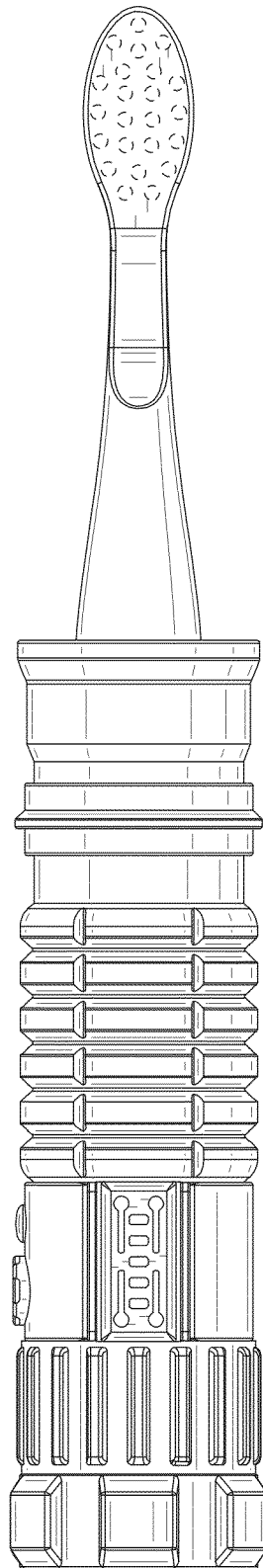

Fig. 1

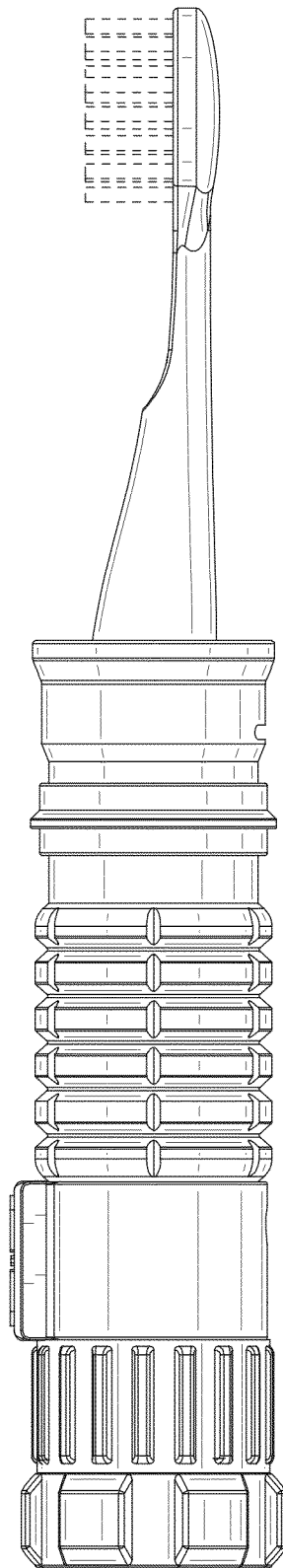

Fig. 2

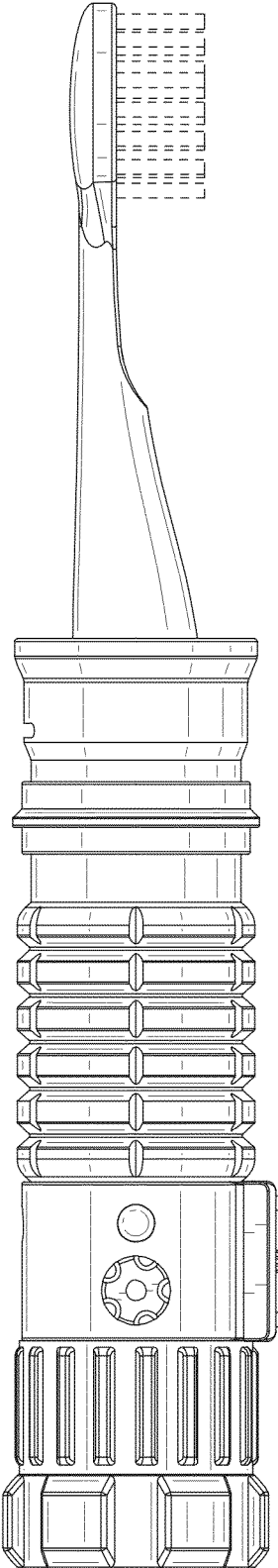

Fig. 3

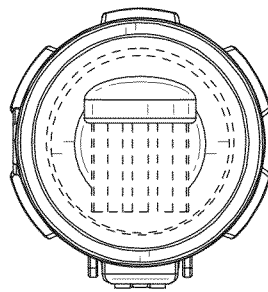

Fig. 4

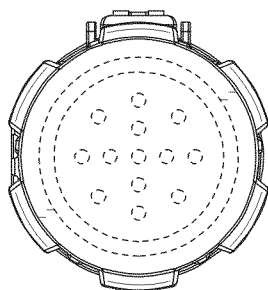

Fig. 5

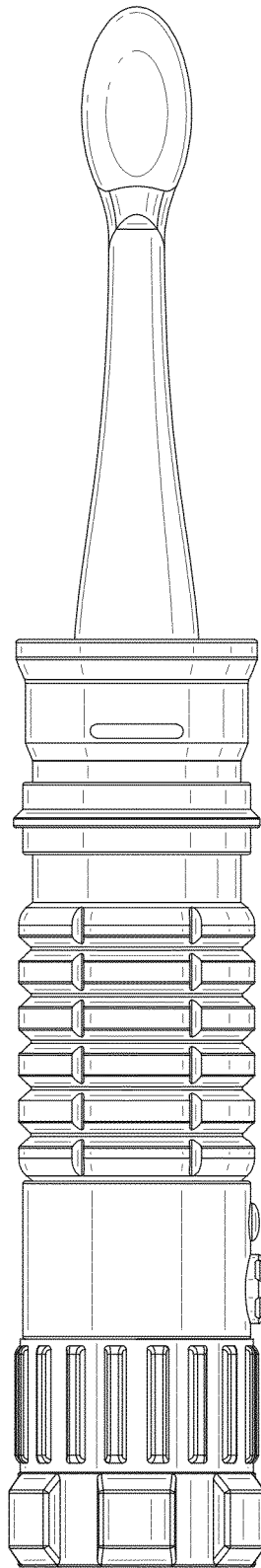

Fig. 6

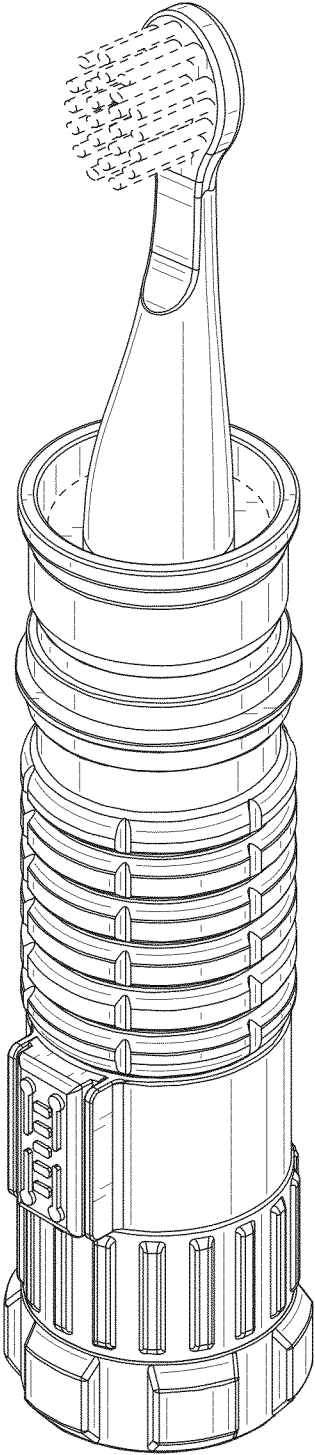

Fig. 7