



US00D473314S

(12) **United States Design Patent** (10) **Patent No.:** **US D473,314 S**  
Since (45) **Date of Patent:** **\*\* Apr. 15, 2003**

- (54) **CONTROL UNIT**
- (75) Inventor: **Guillaume Since**, Tseung Kwan O (HK)
- (73) Assignee: **Salton Inc.**, Lake Forest, IL (US)
- (\*\*) Term: **14 Years**
- (21) Appl. No.: **29/153,428**
- (22) Filed: **Jan. 8, 2002**
- (51) **LOC (7) Cl.** ..... **24-04**
- (52) **U.S. Cl.** ..... **D24/200; D13/162**
- (58) **Field of Search** ..... D13/162, 168; D24/200, 215; 5/632; 601/69, 70, 71, 72, 73, 150

*Primary Examiner*—James Gandy  
*Assistant Examiner*—Selina Sikder  
(74) *Attorney, Agent, or Firm*—Sonnenschein Nath & Rosenthal

(57) **CLAIM**

The ornamental design for a control unit, as shown and described.

**DESCRIPTION**

FIG. 1 illustrates a front elevational view of a control unit embodying the present design.

FIG. 2 illustrates a rear elevational view of the control unit of FIG. 1.

FIG. 3 illustrates a front perspective view of the control unit of FIG. 1.

FIG. 4 illustrates a rear perspective view of the control unit of FIG. 1.

FIG. 5 illustrates a side elevational view of the control unit of FIG. 1, the reverse side being a mirror image thereof.

FIG. 6 illustrates a bottom plan view of the control unit of FIG. 1; and,

FIG. 7 illustrates a top plan view of the control unit of FIG. 1.

The broken lines in FIGS. 1-7 are for illustrative purposes only and form no part of the claimed invention.

(56) **References Cited**  
**U.S. PATENT DOCUMENTS**

D352,358 S	*	11/1994	Yan	.....	D24/200
5,611,722 A	*	3/1997	Fujimoto et al.	.....	601/149
D389,124 S	*	1/1998	Givati	.....	D13/184
5,876,359 A	*	3/1999	Bock et al.	.....	601/150
5,951,502 A	*	9/1999	Peeler et al.	.....	601/149
5,970,545 A	*	10/1999	Garman et al.	.....	5/615
D452,570 S	*	12/2001	Since	.....	D24/200
6,375,630 B1	*	4/2002	Cutler et al.	.....	601/57

\* cited by examiner

**1 Claim, 7 Drawing Sheets**

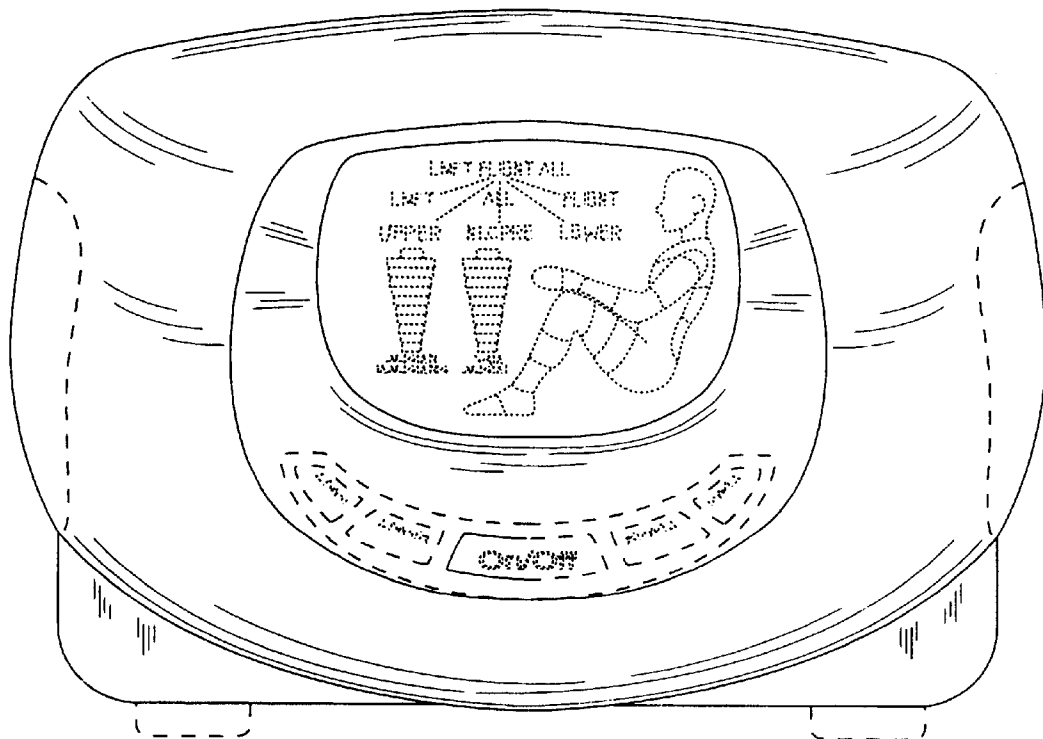

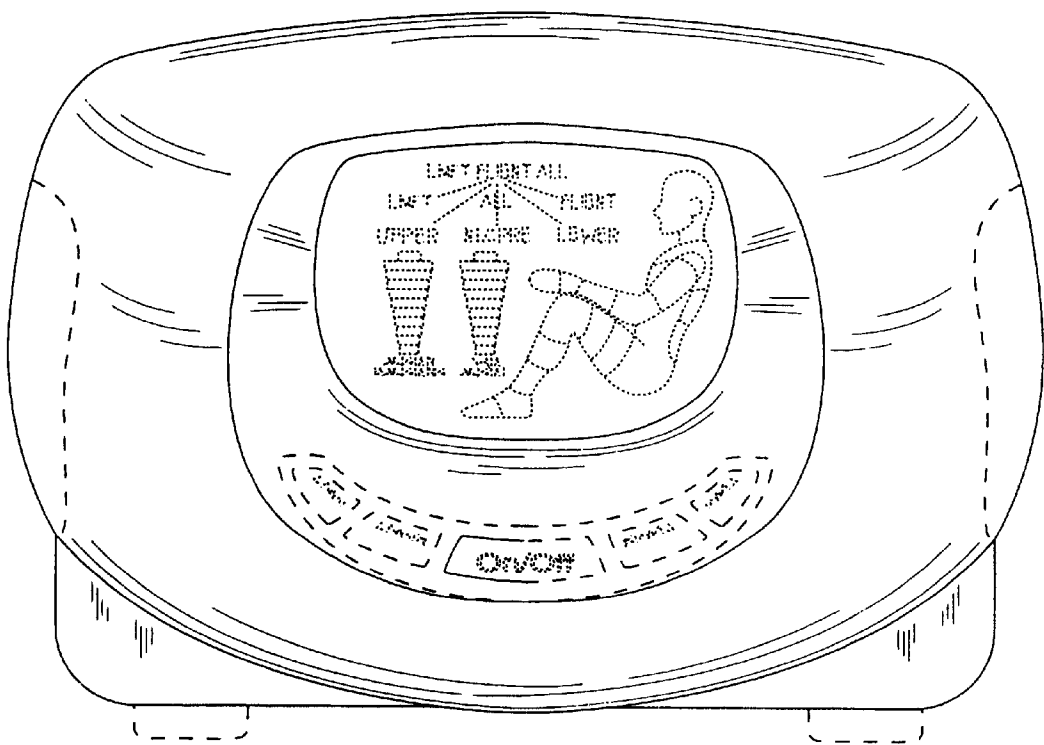

Fig. 1

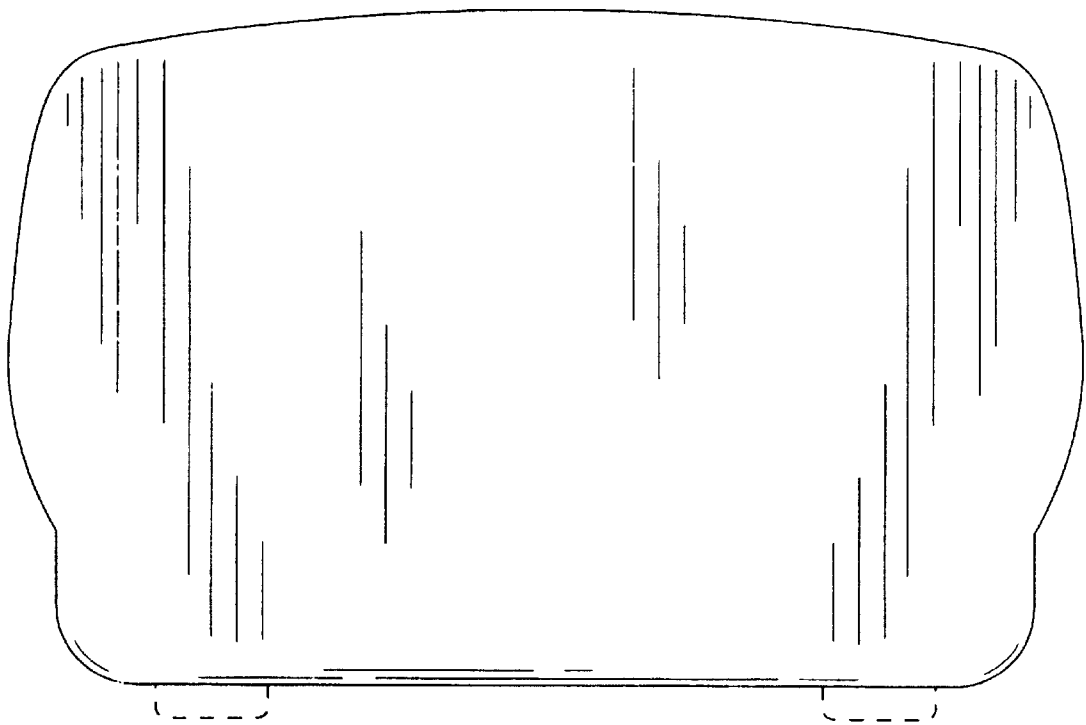

Fig. 2

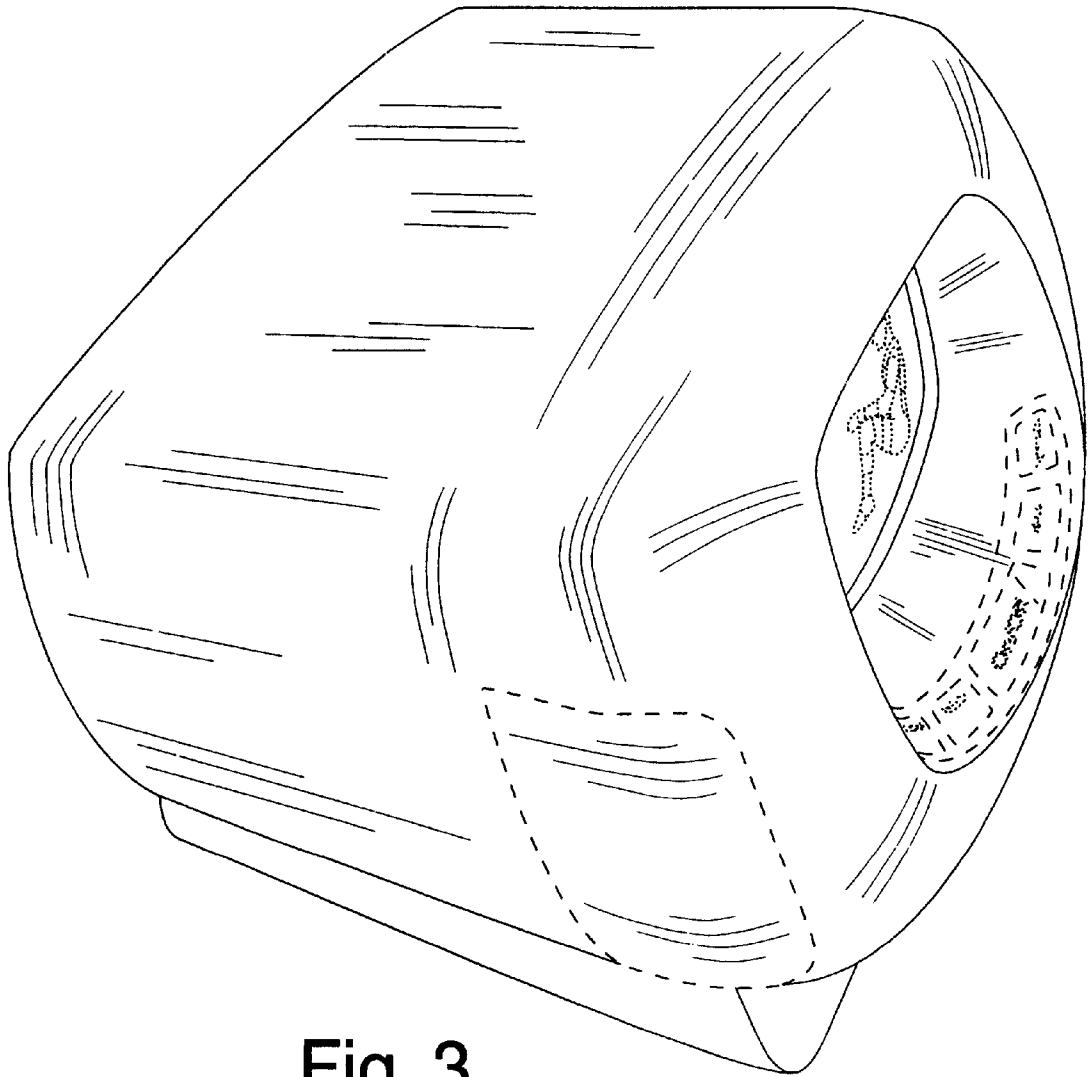

Fig. 3

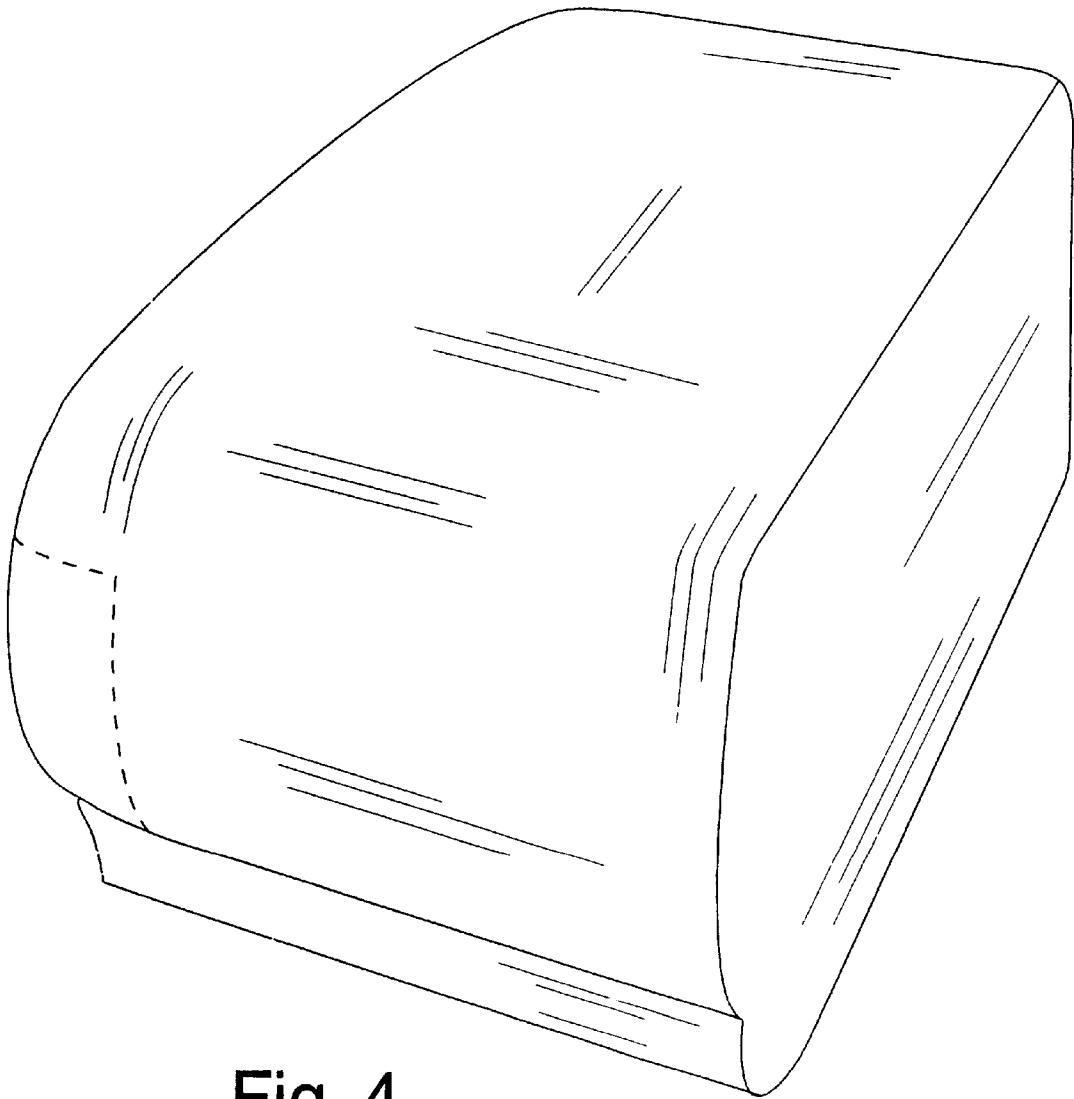

Fig. 4

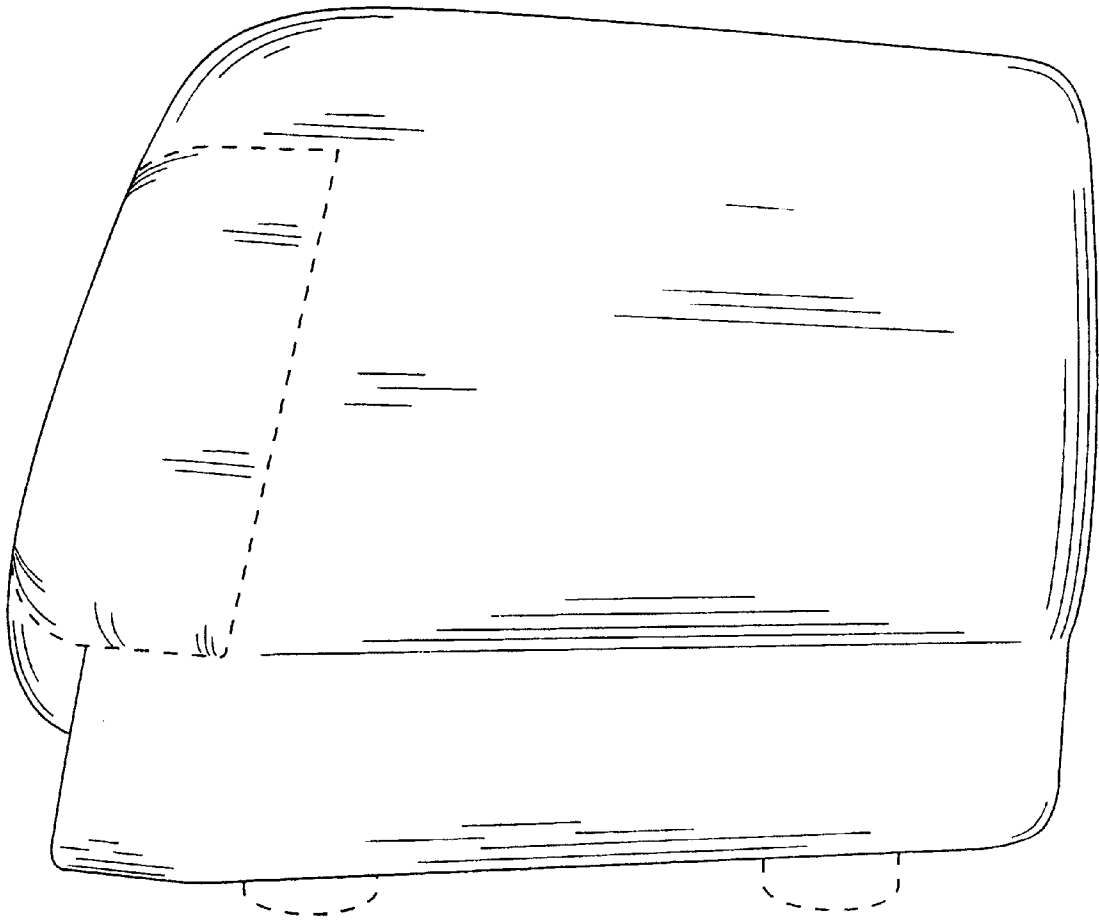

Fig. 5

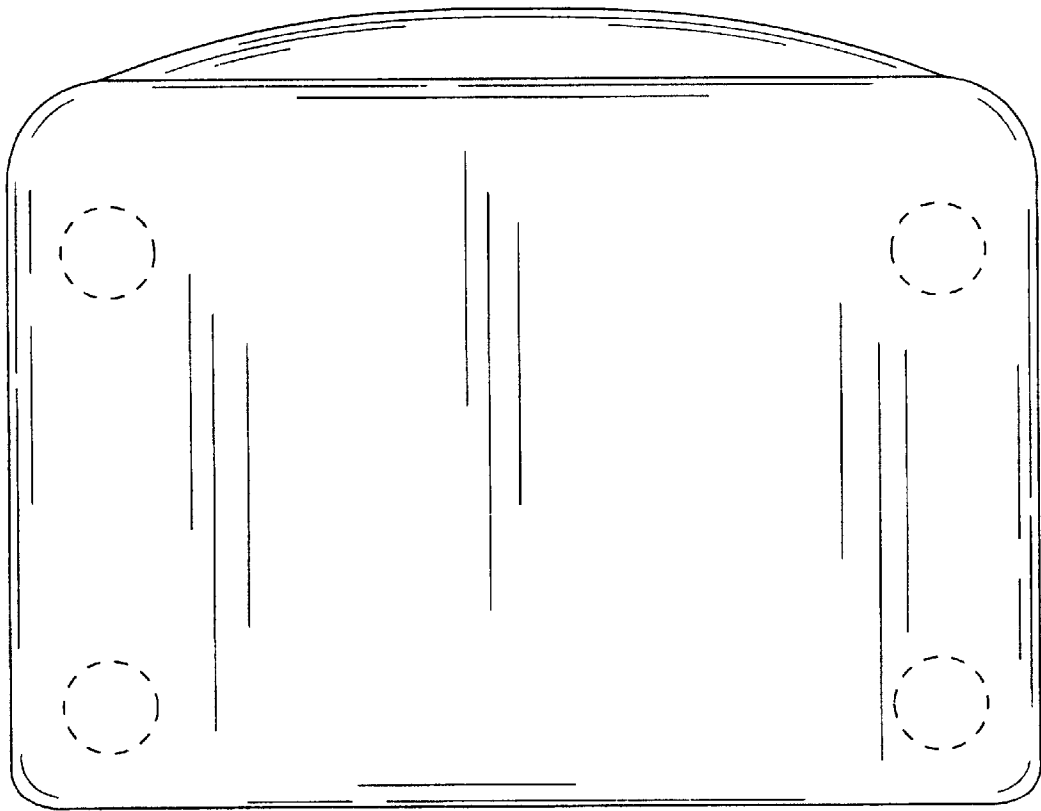

Fig. 6

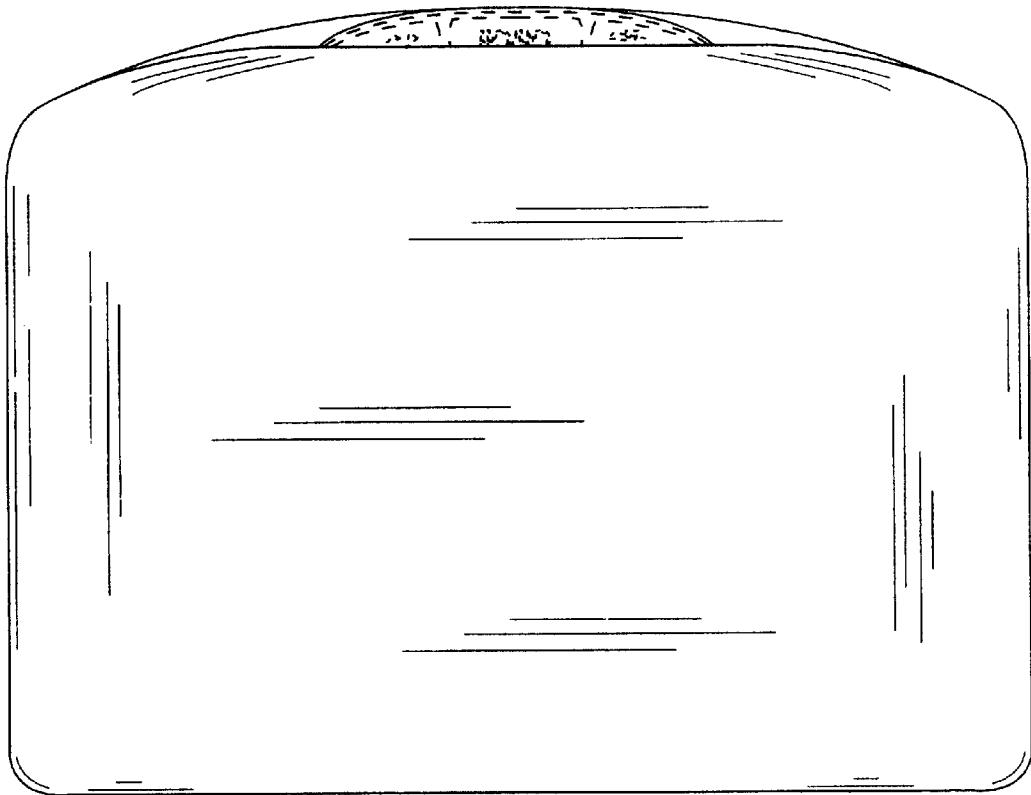

Fig. 7