



US00D632452S

(12) **United States Design Patent**  
**Elhaj**

(10) **Patent No.:** **US D632,452 S**

(45) **Date of Patent:** **\*\* \*Feb. 8, 2011**

(54) **BROKEN HEART SHAPED COFFIN**

(76) Inventor: **Antoine Elhaj**, 3712 Columbus Ave., Sandusky, OH (US) 44870

(\* ) Notice: This patent is subject to a terminal disclaimer.

(\*\*) Term: **14 Years**

(21) Appl. No.: **29/332,651**

(22) Filed: **Feb. 20, 2009**

(51) **LOC (9) Cl.** ..... **99-00**

(52) **U.S. Cl.** ..... **D99/3**

(58) **Field of Classification Search** ..... D99/1-24; 27/1-8, 14, 27, 30; 52/103; 40/124.5

See application file for complete search history.

(56) **References Cited**

U.S. PATENT DOCUMENTS

D355,065	S	*	1/1995	Hicks	.....	D99/5
D437,670	S	*	2/2001	Rivera et al.	.....	D99/5
D470,991	S	*	2/2003	Goldstein	.....	D99/5
D476,130	S	*	6/2003	Joy et al.	.....	D99/5
D509,637	S	*	9/2005	Wozniak	.....	D99/5
D515,267	S	*	2/2006	Wozniak	.....	D99/5
D543,005	S	*	5/2007	Pertz	.....	D99/5

\* cited by examiner

*Primary Examiner*—T. Chase Nelson  
*Assistant Examiner*—Michael A Pratt  
(74) *Attorney, Agent, or Firm*—Ronald J Koch

(57) **CLAIM**

The ornamental design for a broken heart shaped coffin, as shown and described.

**DESCRIPTION**

The present application is related to the co-pending patent application Ser. No. 12/390,400 of Antoine Elhaj, filed Feb. 20, 2009, entitled "Broken Heart Shaped Coffin", and based on which priority is herewith claimed under 35 U.S.C. 120 and the disclosure of which is incorporated herein by reference in its entirety as if fully rewritten herein.

FIG. 1 depicts a perspective view slightly from above.

FIG. 2 depicts a perspective view slightly from below.

FIG. 3 depicts the view from a first end.

FIG. 4 depicts the view from a second end opposite the first end.

FIG. 5 depicts a top view.

FIG. 6 depicts a bottom view; and,

FIG. 7 depicts a side view.

**1 Claim, 5 Drawing Sheets**

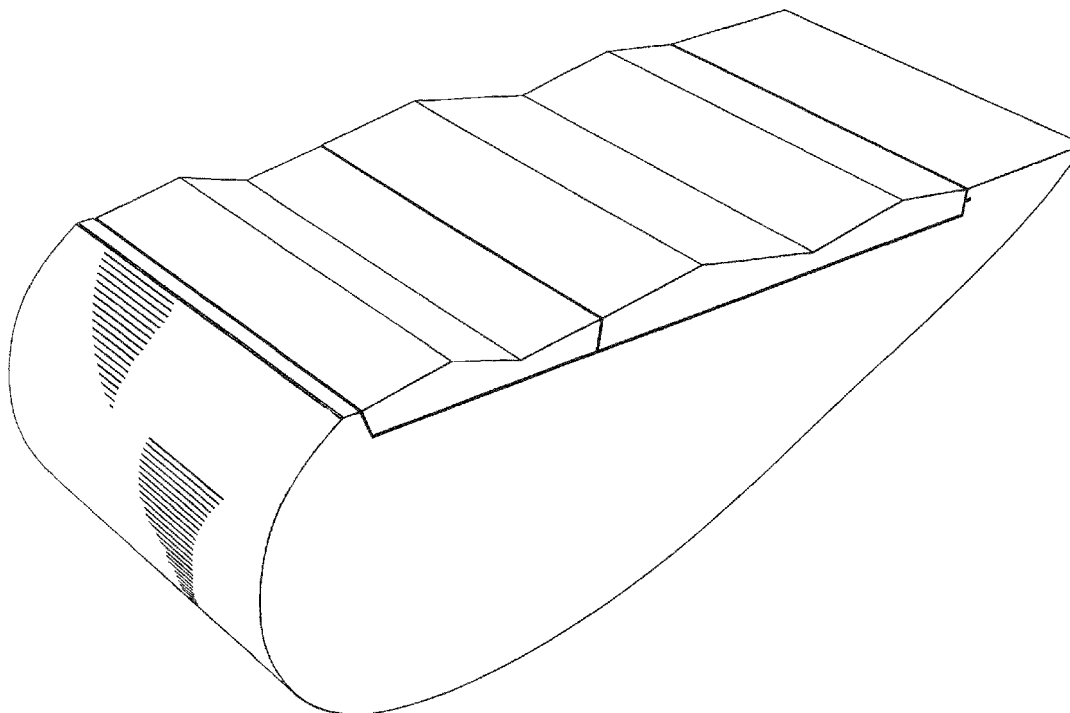

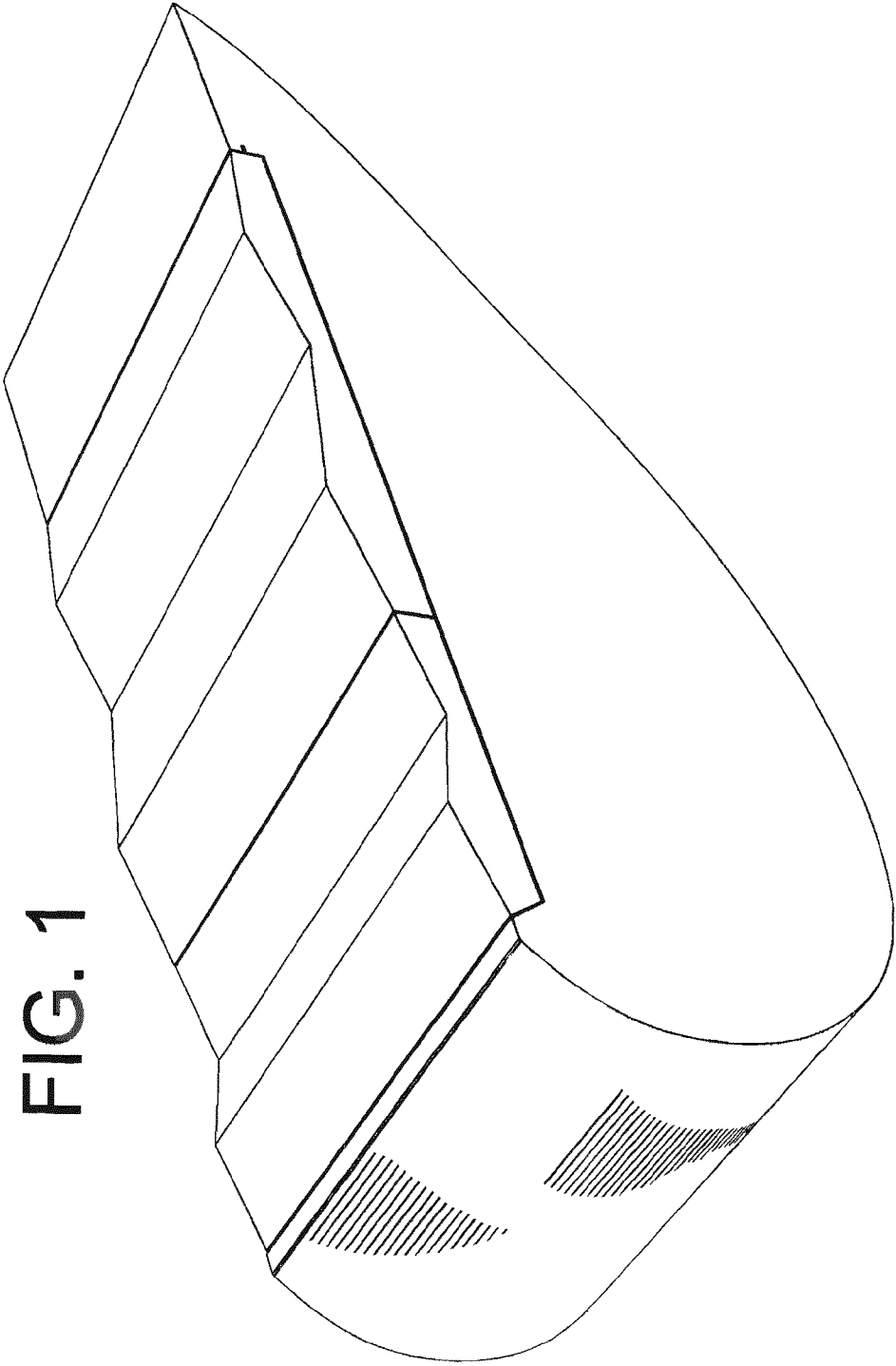

FIG. 1

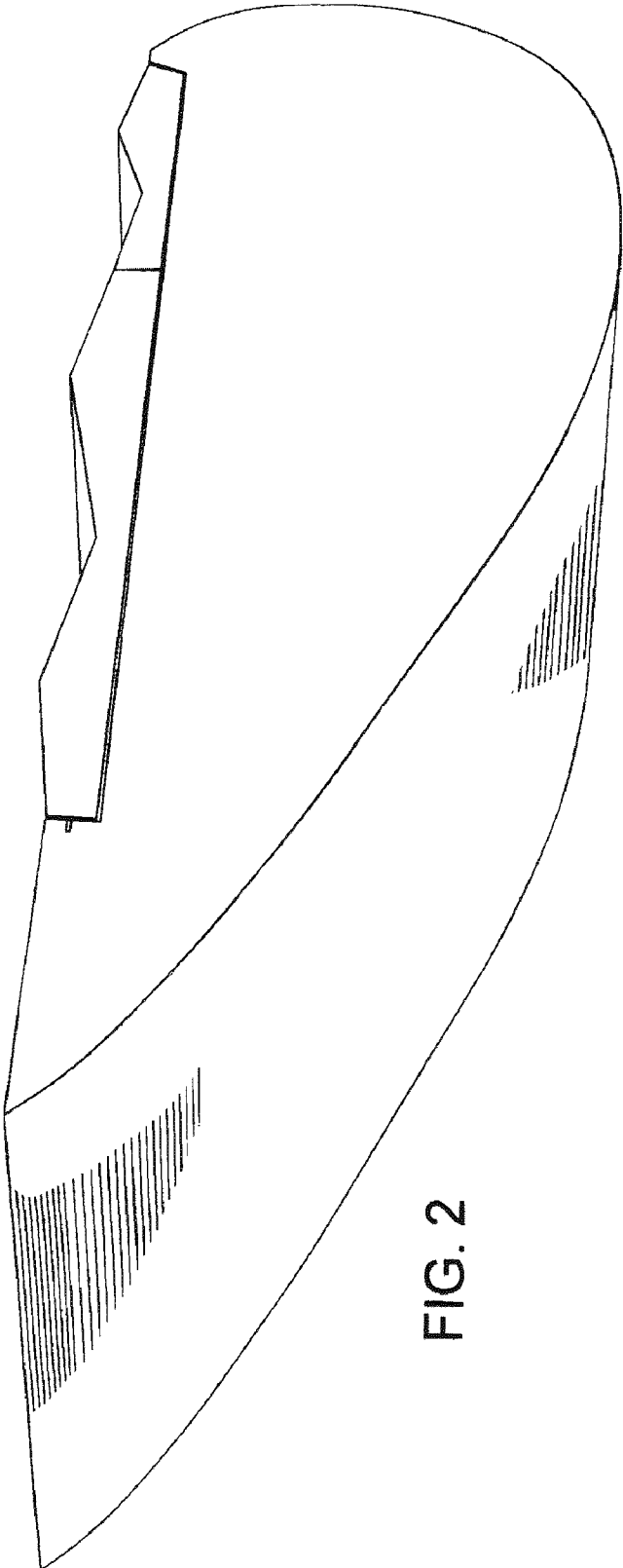

FIG. 2

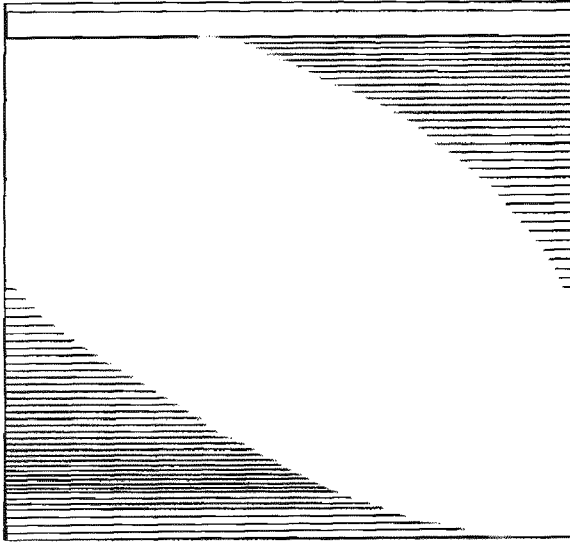

FIG. 3

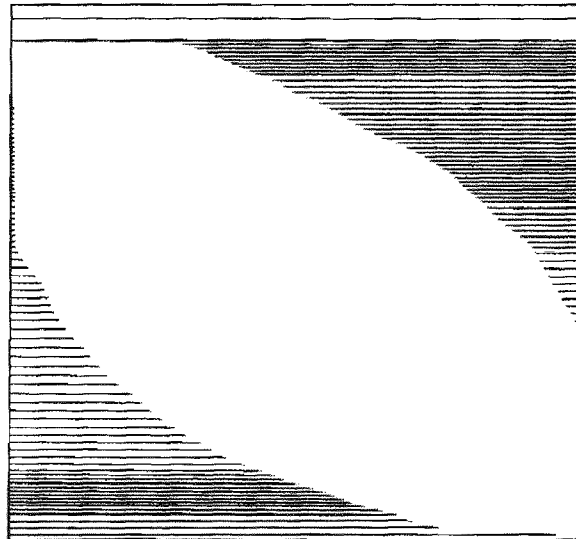

FIG. 4

FIG. 5

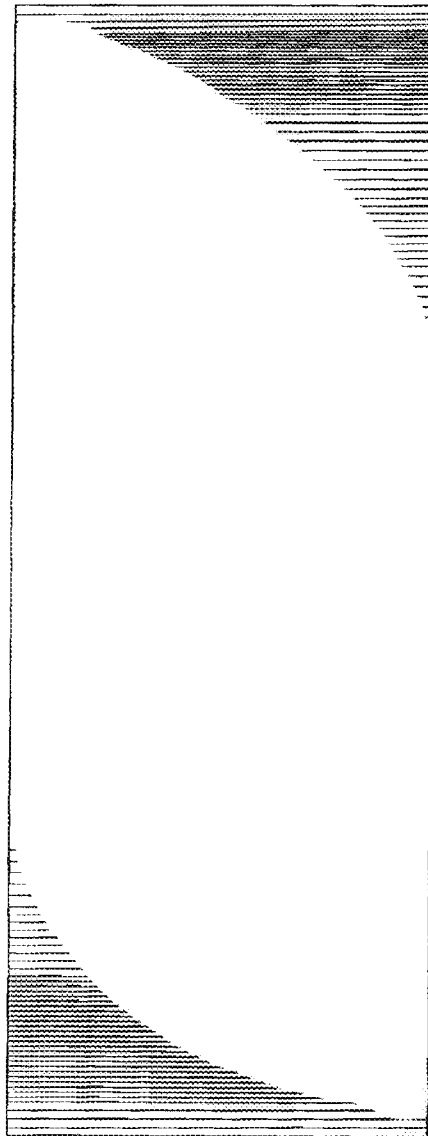
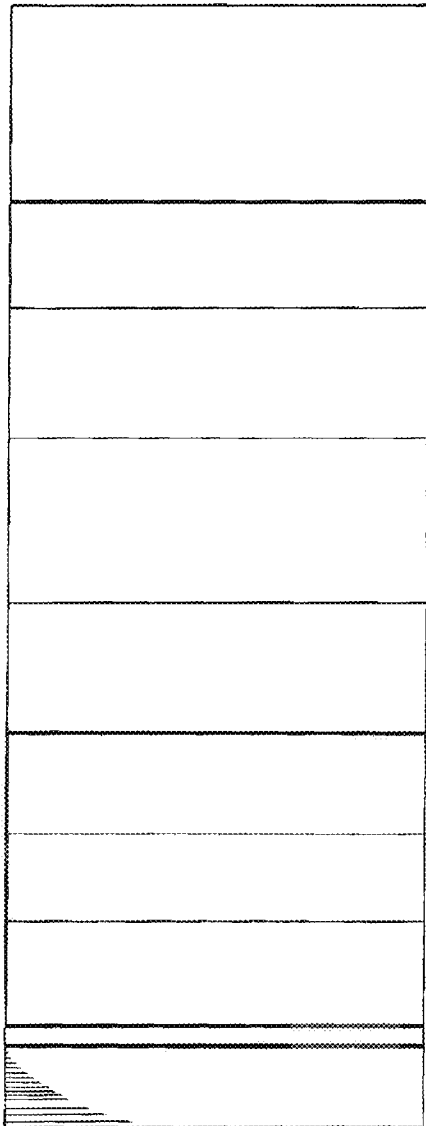

FIG. 6

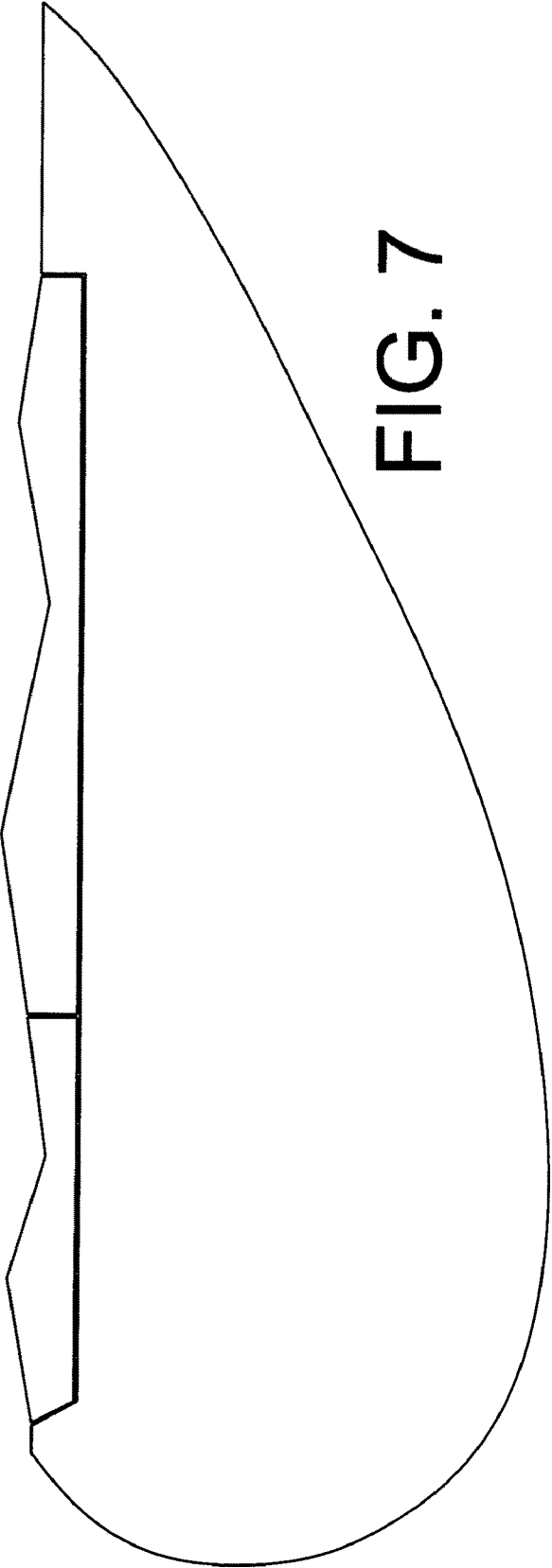

FIG. 7