



US00D474626S

(12) **United States Design Patent** (10) **Patent No.:** **US D474,626 S**
Landsberger et al. (45) **Date of Patent:** **** May 20, 2003**

(54) **MODULAR LABORATORY CABINET**

Primary Examiner—Cathron C. Brooks
(74) *Attorney, Agent, or Firm*—Lawrence G. Fridman

(75) Inventors: **David Landsberger**, Caldwell, NJ (US); **Paul Thom**, Clifton, NJ (US); **Francis Gomes**, Jersey City, NJ (US)

(57) **CLAIM**

The ornamental design for modular laboratory cabinet, as shown and described.

(73) Assignee: **Bel-Art Products, Inc.**, Pequannock, NJ (US)

DESCRIPTION

(**) Term: **14 Years**

(21) Appl. No.: **29/157,744**

(22) Filed: **Mar. 25, 2002**

(51) **LOC (7) Cl.** **06-04**

(52) **U.S. Cl.** **D6/432**

(58) **Field of Search** D6/432, 440, 441, D6/448; D3/273; D9/414, 423, 432; D99/28; 206/503, 511; 312/209

FIG. 1 is a perspective view of one embodiment of the modular laboratory cabinet according to our new design; FIG. 2 is a perspective view of another embodiment of the invention, the sole difference residing in the color coordination that is shown;

FIG. 3 is a front elevational view thereof;

FIG. 4 is a rear elevational view thereof;

FIG. 5 is a top plan view thereof;(a bottom plan view is a mirror image of FIG. 5);

FIG. 6 is a left-hand side elevational view thereof;

FIG. 7 is a right-hand side elevational view thereof;

FIG. 8 is a front elevational view of another embodiment of the invention having two modular units;

FIG. 9 is a rear elevational view thereof;

FIG. 10 is a top plan view thereof;

FIG. 11 is a bottom plan view thereof;

FIG. 12 is a left-hand side elevational view thereof;

FIG. 13 is a right-hand side elevational view thereof;

FIG. 14 is a front elevational view of a further embodiment of the invention having three modular units;

FIG. 15 is a rear elevational view thereof;

FIG. 16 is a top plan view thereof; (a bottom plan view is a mirror image of FIG. 16);

FIG. 17 is a left-hand side elevational view thereof;

FIG. 18 is a right-hand side elevational view thereof;

FIG. 19 is a front elevational view showing still another embodiment of the invention having four modular units;

FIG. 20 is a rear elevational view thereof;

FIG. 21 is a top plan view thereof; (a bottom plan view thereof is a mirror image of the view shown in FIG. 21);

FIG. 22 is a left-hand side elevational view thereof; and,

FIG. 23 is a right-hand side elevational view thereof.

The broken lines shown are for illustrative purposes only and form no part of the claimed design.

(56)

References Cited

U.S. PATENT DOCUMENTS

3,305,287	A	2/1967	Rait	
4,226,488	A	10/1980	Vincent	
4,277,120	A	7/1981	Drake et al.	
4,288,136	A	9/1981	Le Mer	
4,453,789	A	6/1984	Gullong	
D293,746	S	* 1/1988	Sayward	D6/448
5,305,187	A	4/1994	Umezue et al.	
5,407,074	A	* 4/1995	Brightbill et al.	206/511
D360,778	S	* 8/1995	Apt, III et al.	D6/448
D371,962	S	* 7/1996	Petruzzi	D9/423
D380,120	S	* 6/1997	Matos et al.	D6/629
D398,472	S	* 9/1998	Worrell et al.	D6/632
5,810,459	A	9/1998	Barrett et al.	
5,839,806	A	11/1998	Liu	
5,913,580	A	* 6/1999	Liu	312/108
5,975,660	A	11/1999	Tisbo et al.	
D421,685	S	* 3/2000	Carrabba	D6/432
6,099,092	A	8/2000	Uffner et al.	
D432,330	S	* 10/2000	Stettes et al.	D6/432
6,193,340	B1	2/2001	Schenker et al.	
D445,234	S	* 7/2001	Isaacs et al.	D99/28
D464,795	S	* 10/2002	Lin et al.	D3/273

OTHER PUBLICATIONS

Terra Universal, Inc. catalog, pp.: 107, 112, 116, 118, 128, 129, 143, 144 and 151 Bel-Art Products, Inc. catalog 198, pp. 98-112.

* cited by examiner

1 Claim, 17 Drawing Sheets

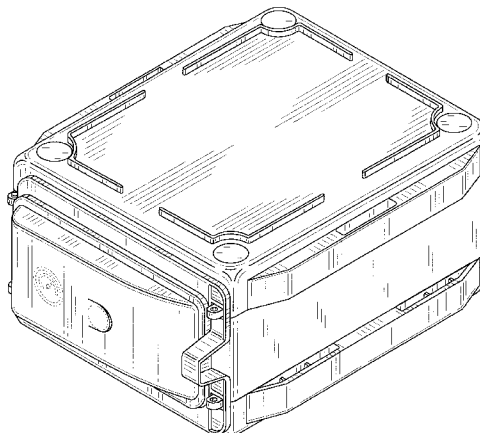

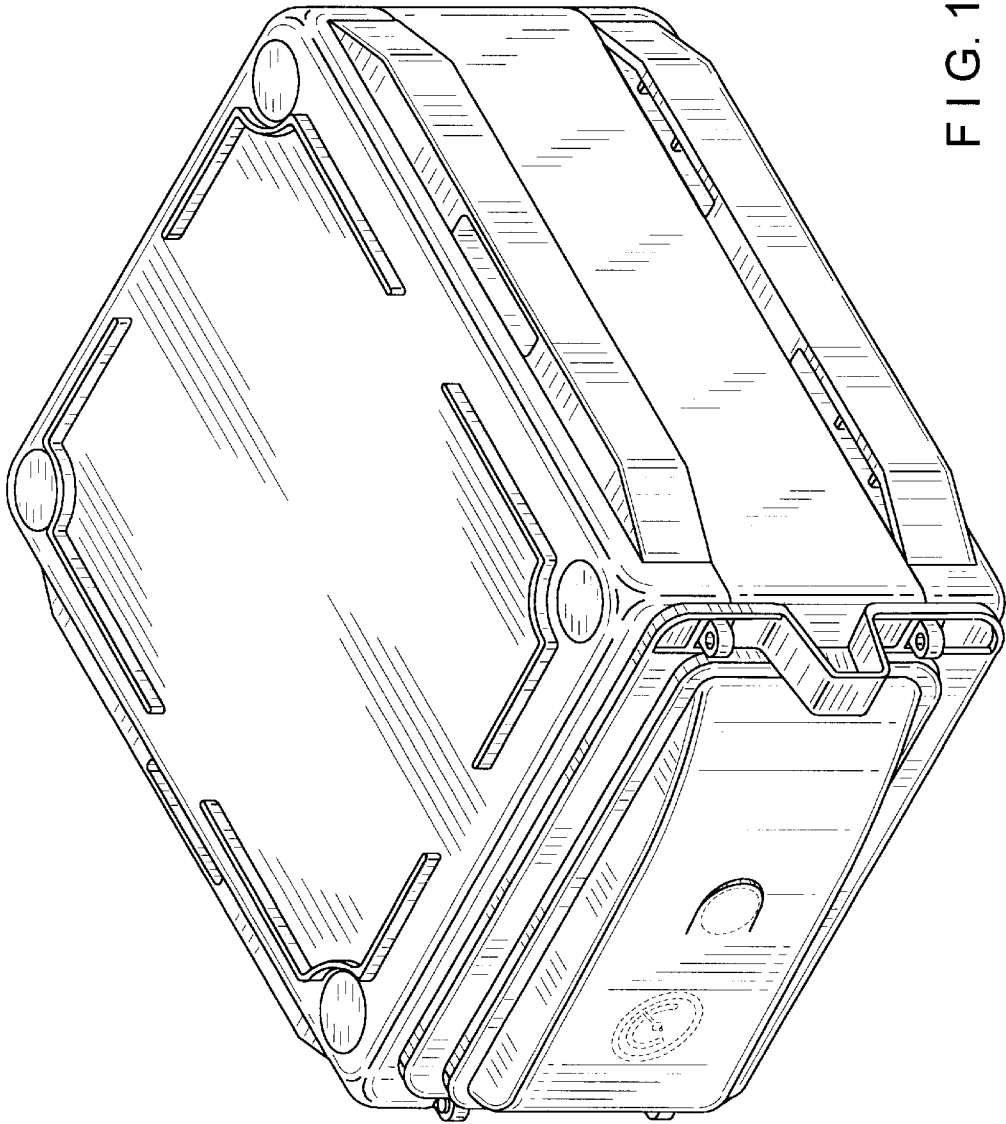

FIG. 1

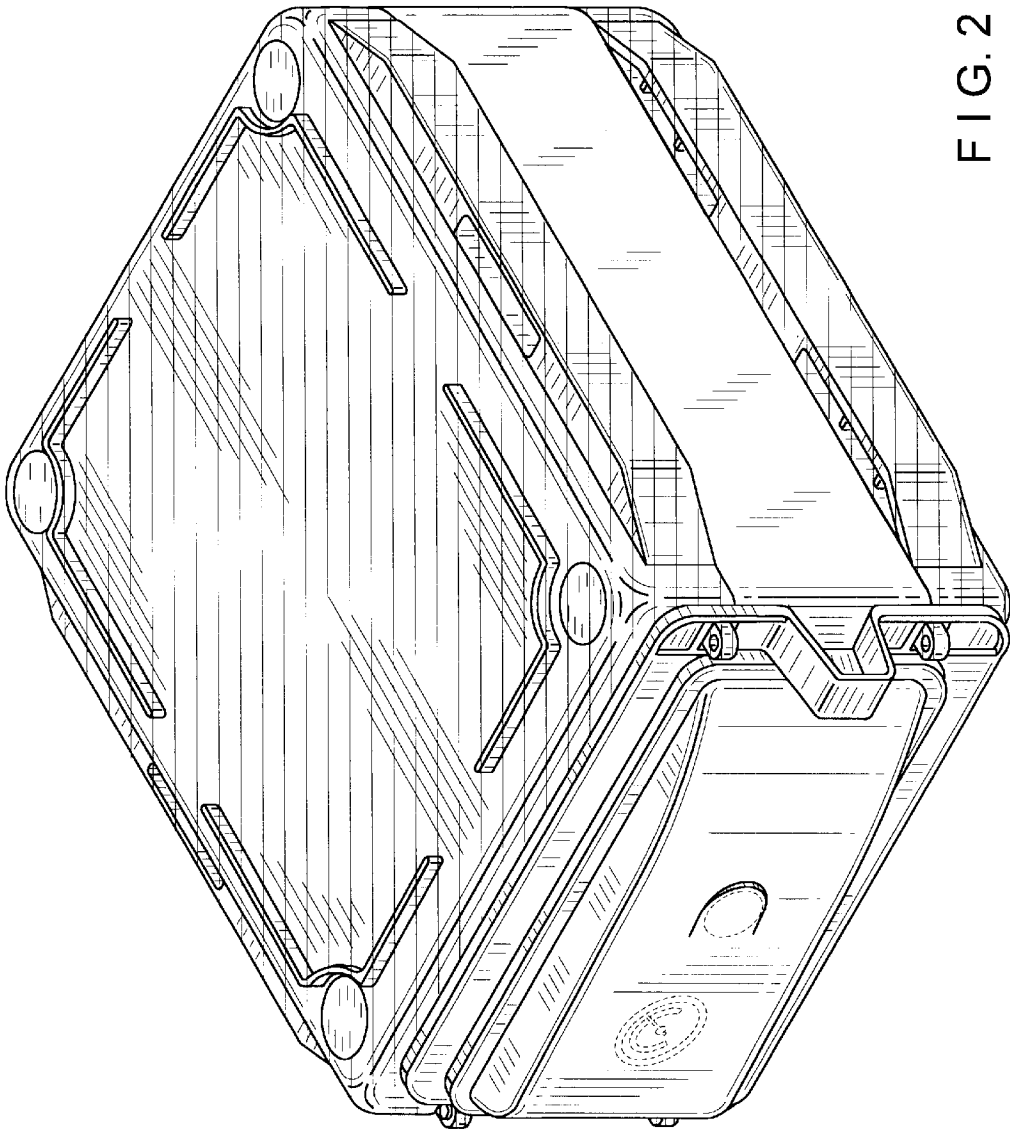

FIG. 2

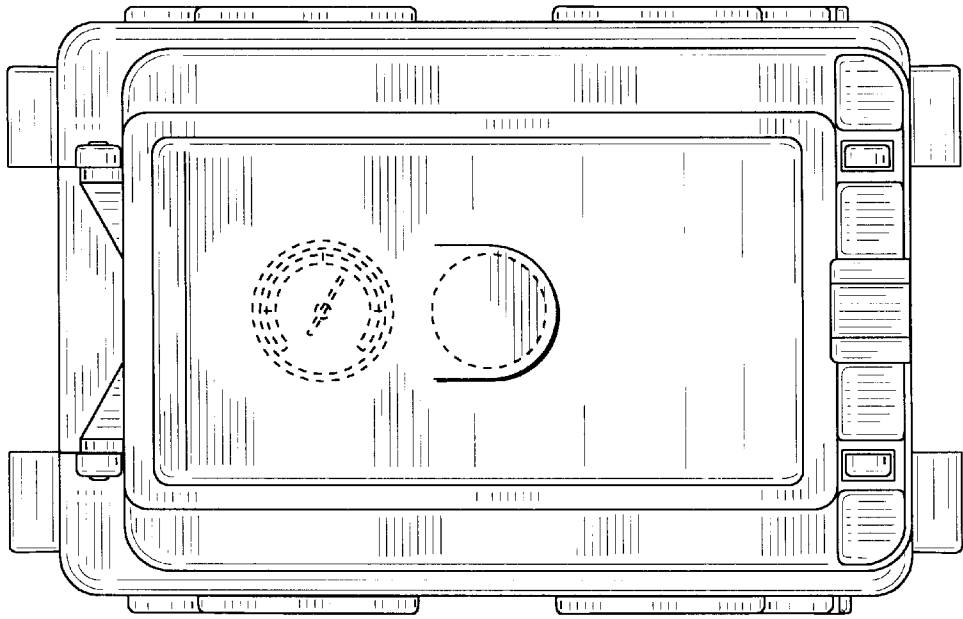

FIG. 3

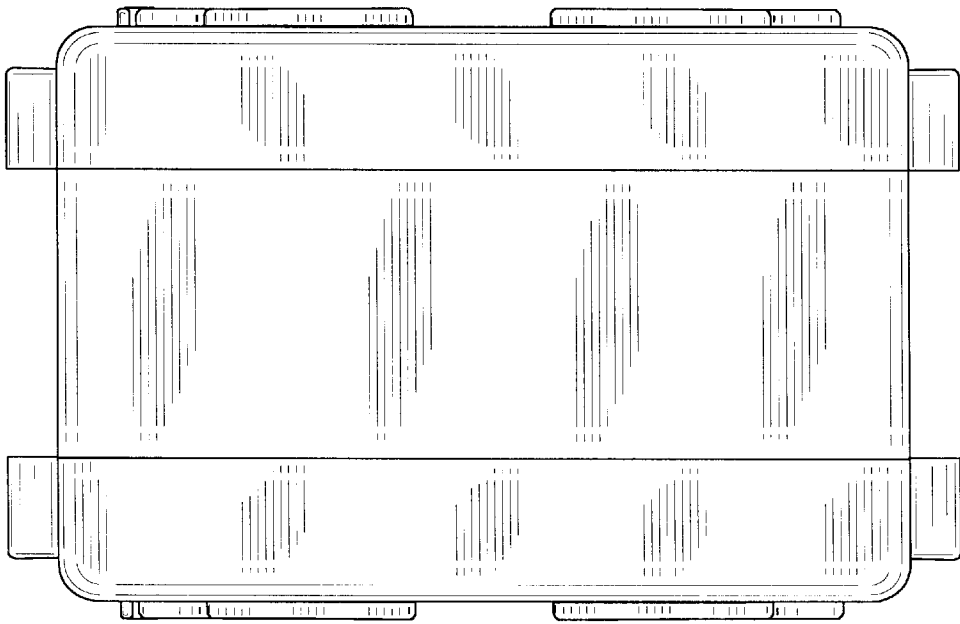

FIG. 4

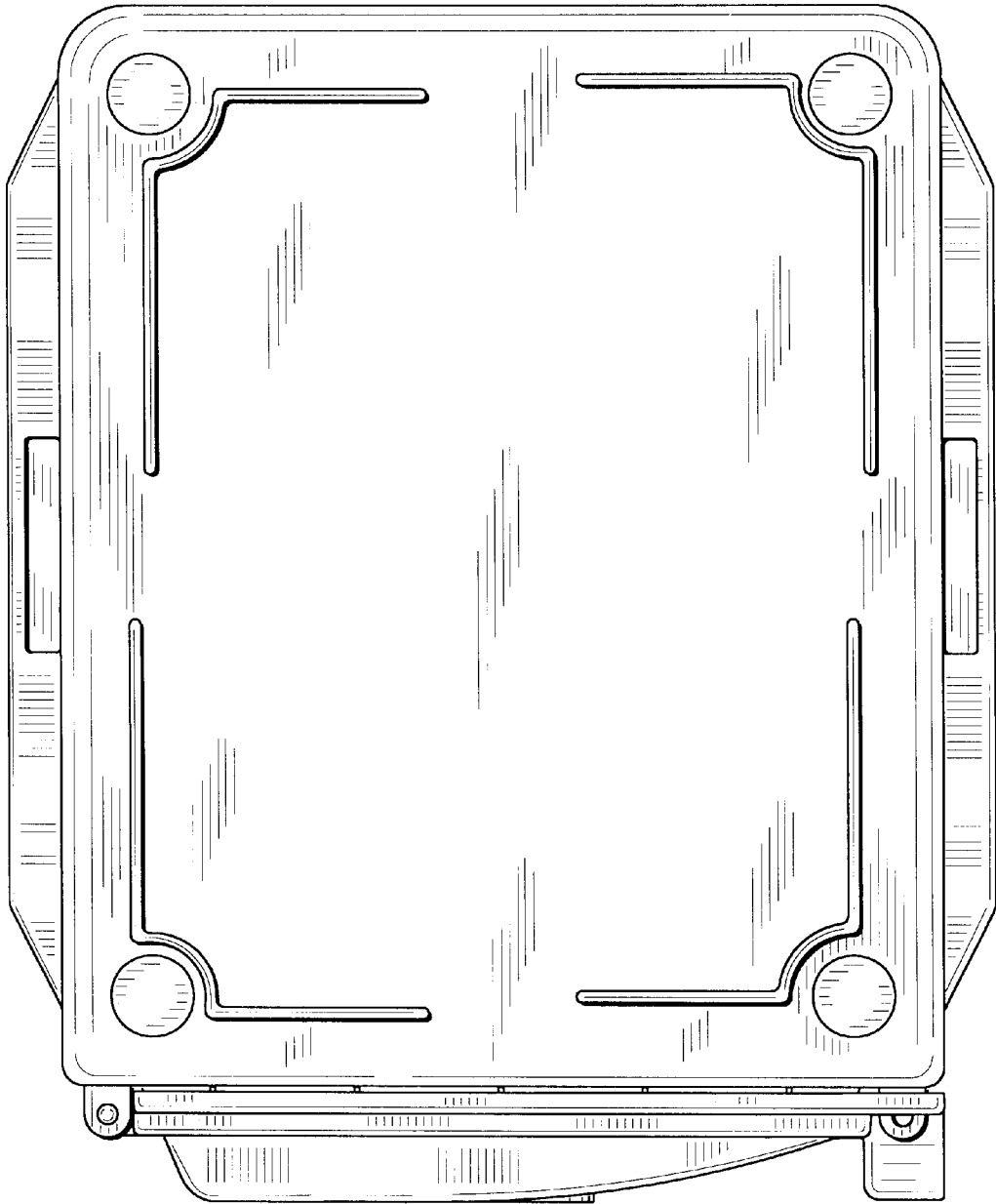

FIG. 5

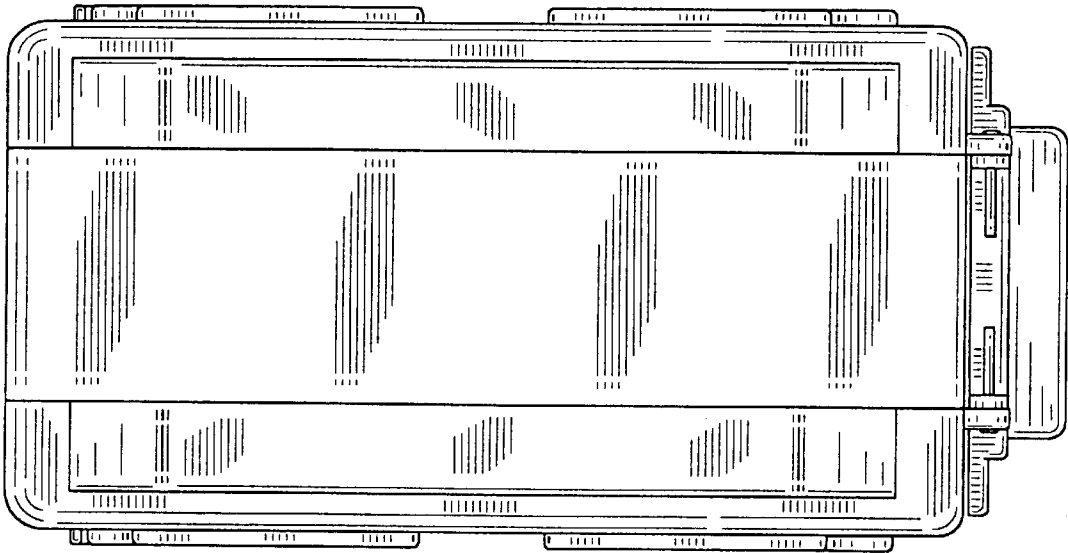

FIG. 6

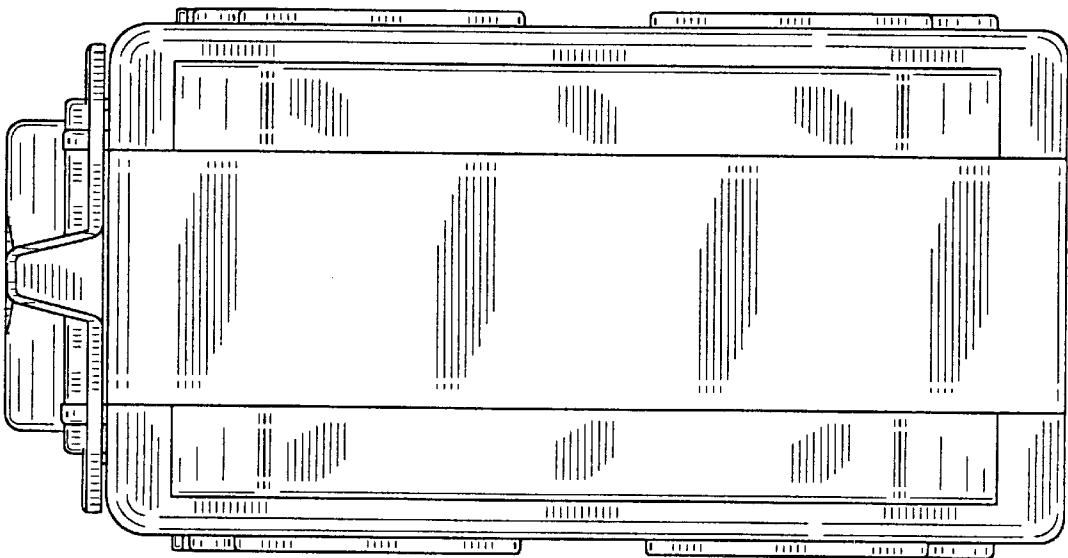

FIG. 7

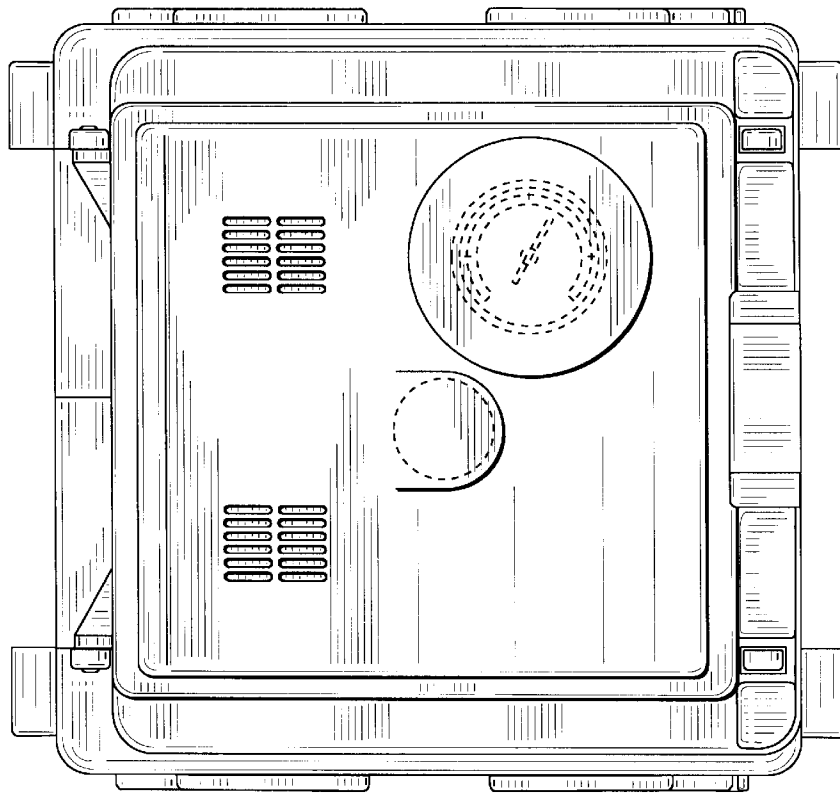

FIG. 8

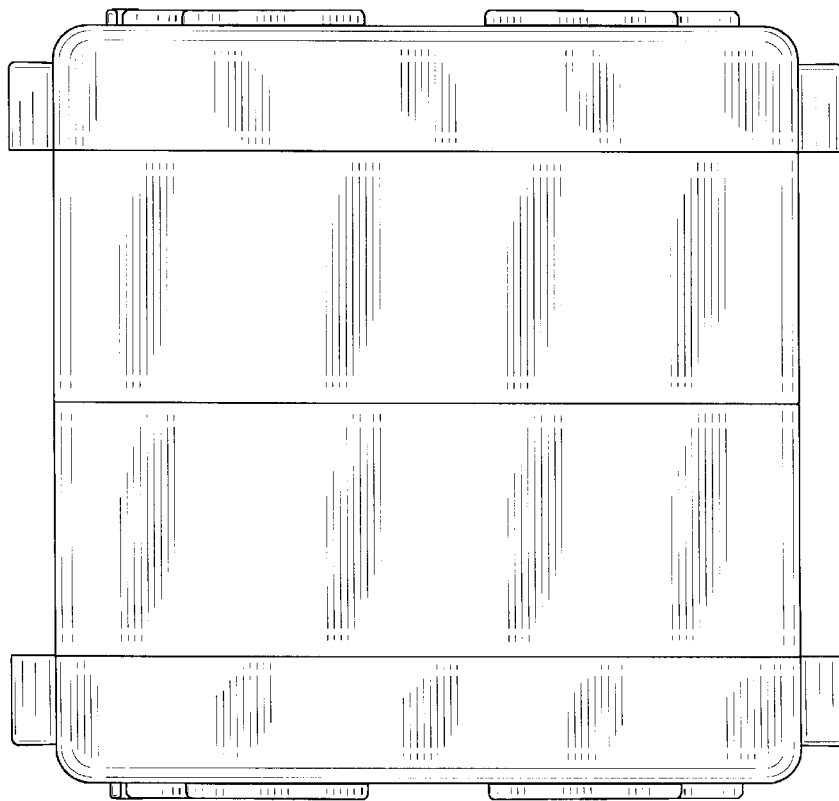

FIG. 9

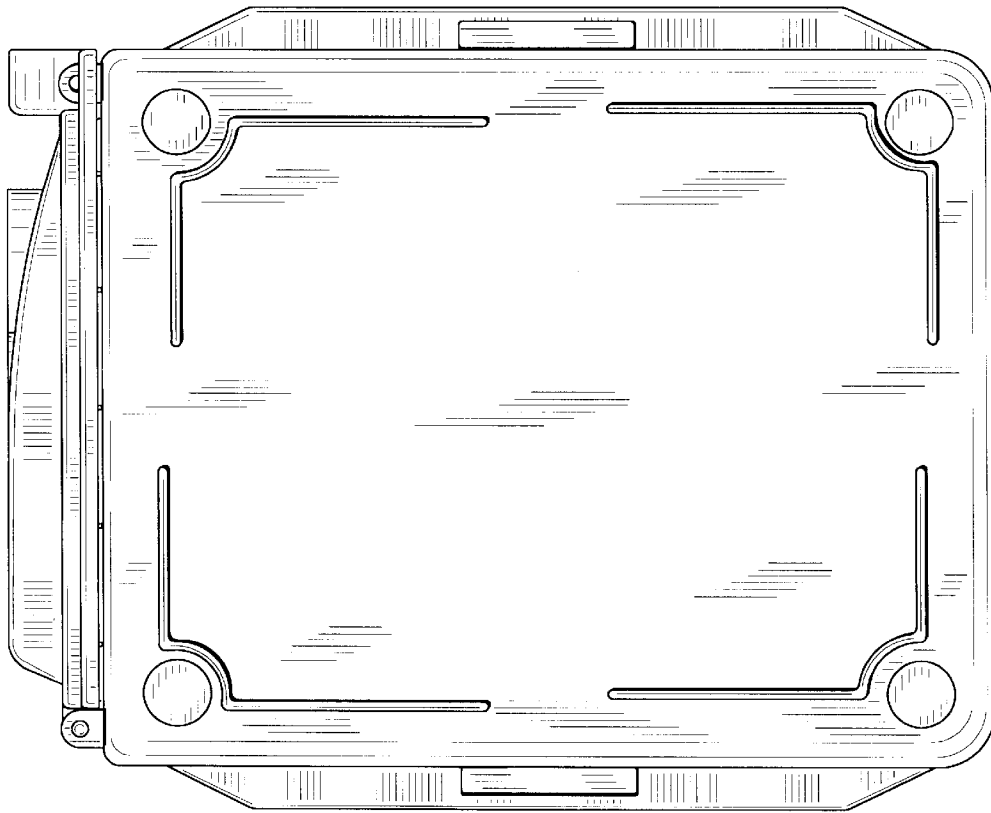

FIG. 11

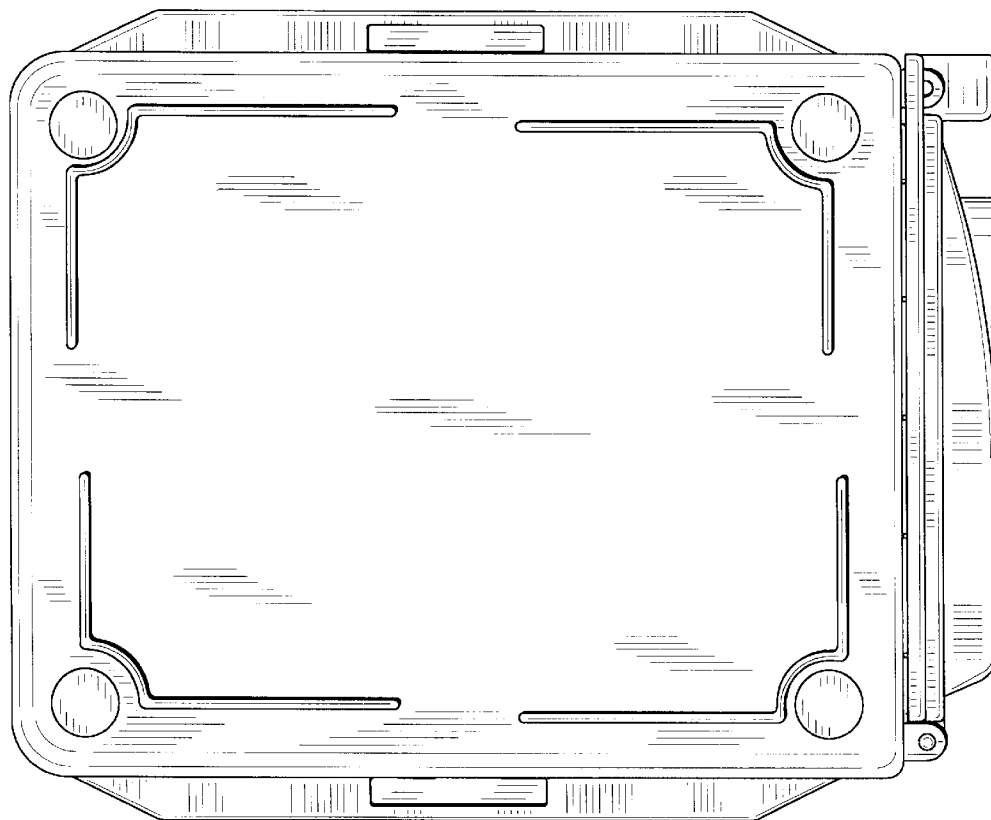

FIG. 10

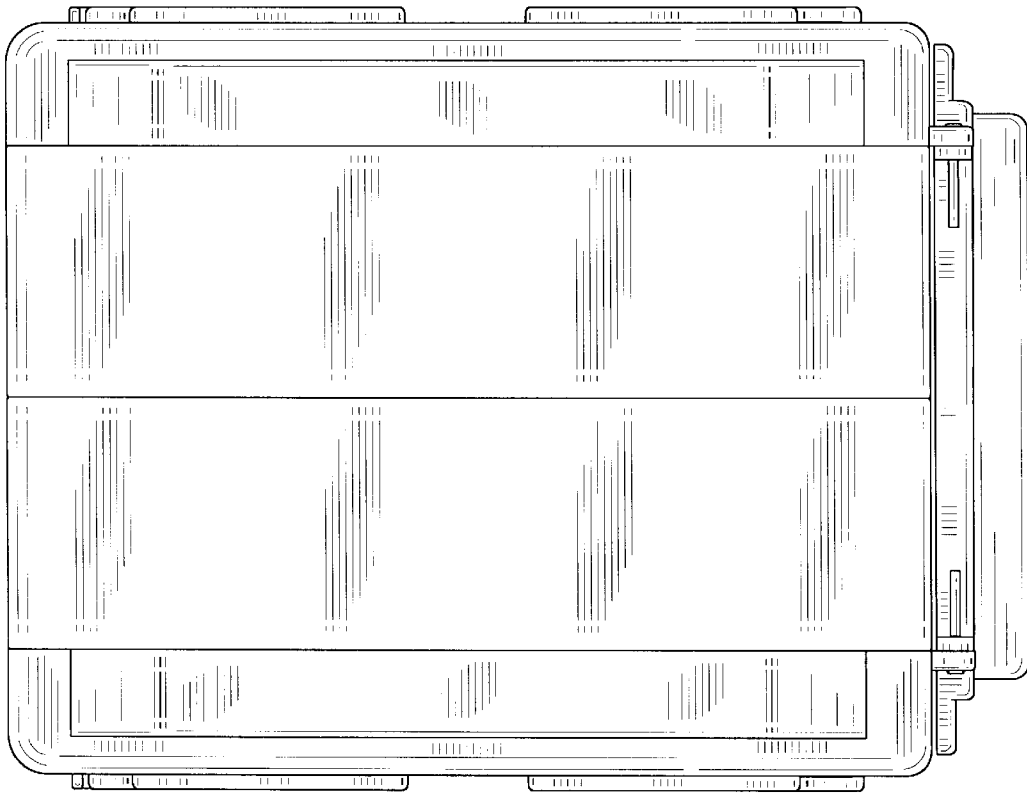

FIG. 12

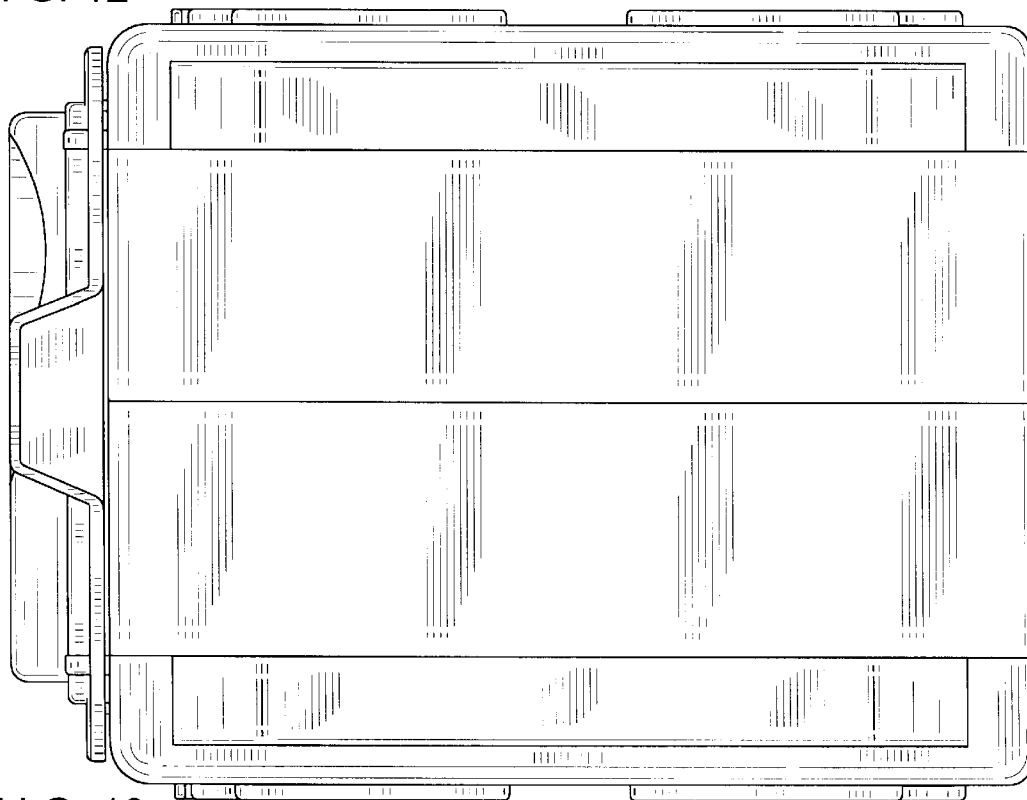

FIG. 13



FIG. 15

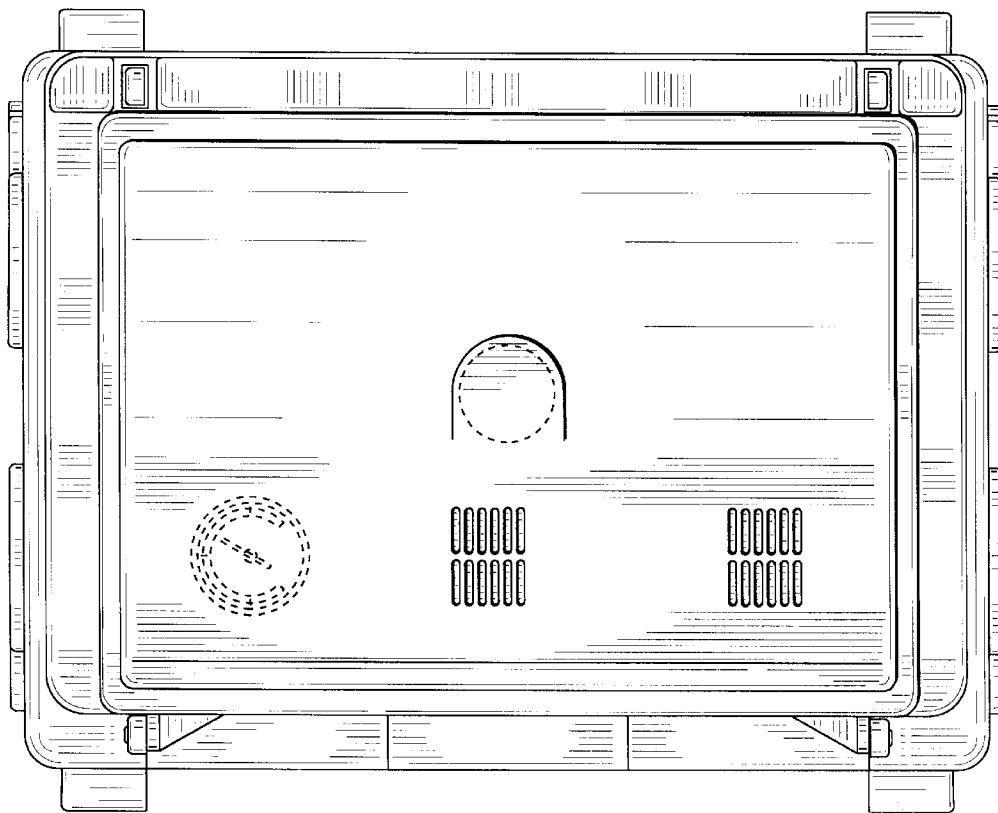

FIG. 14

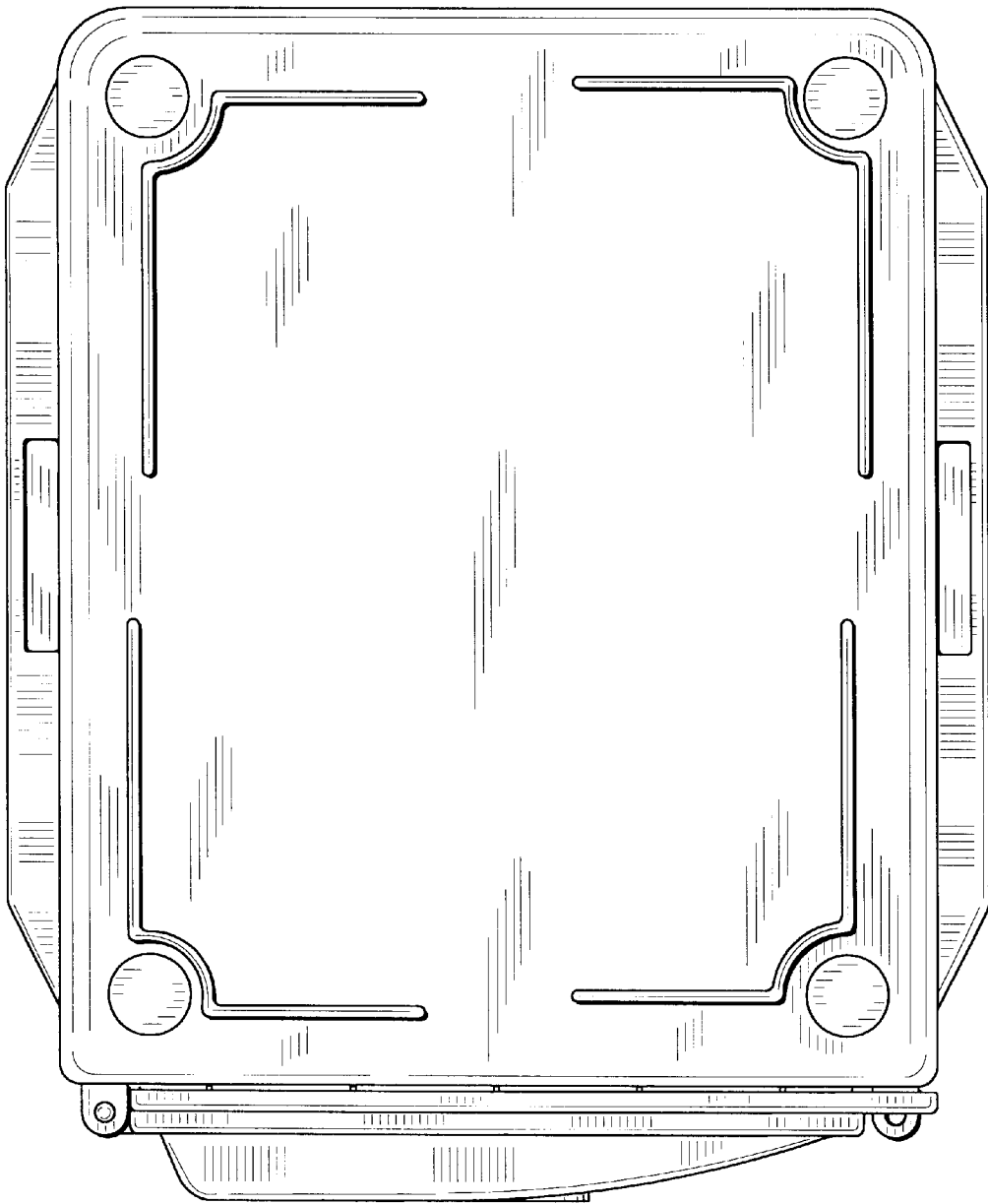

FIG. 16

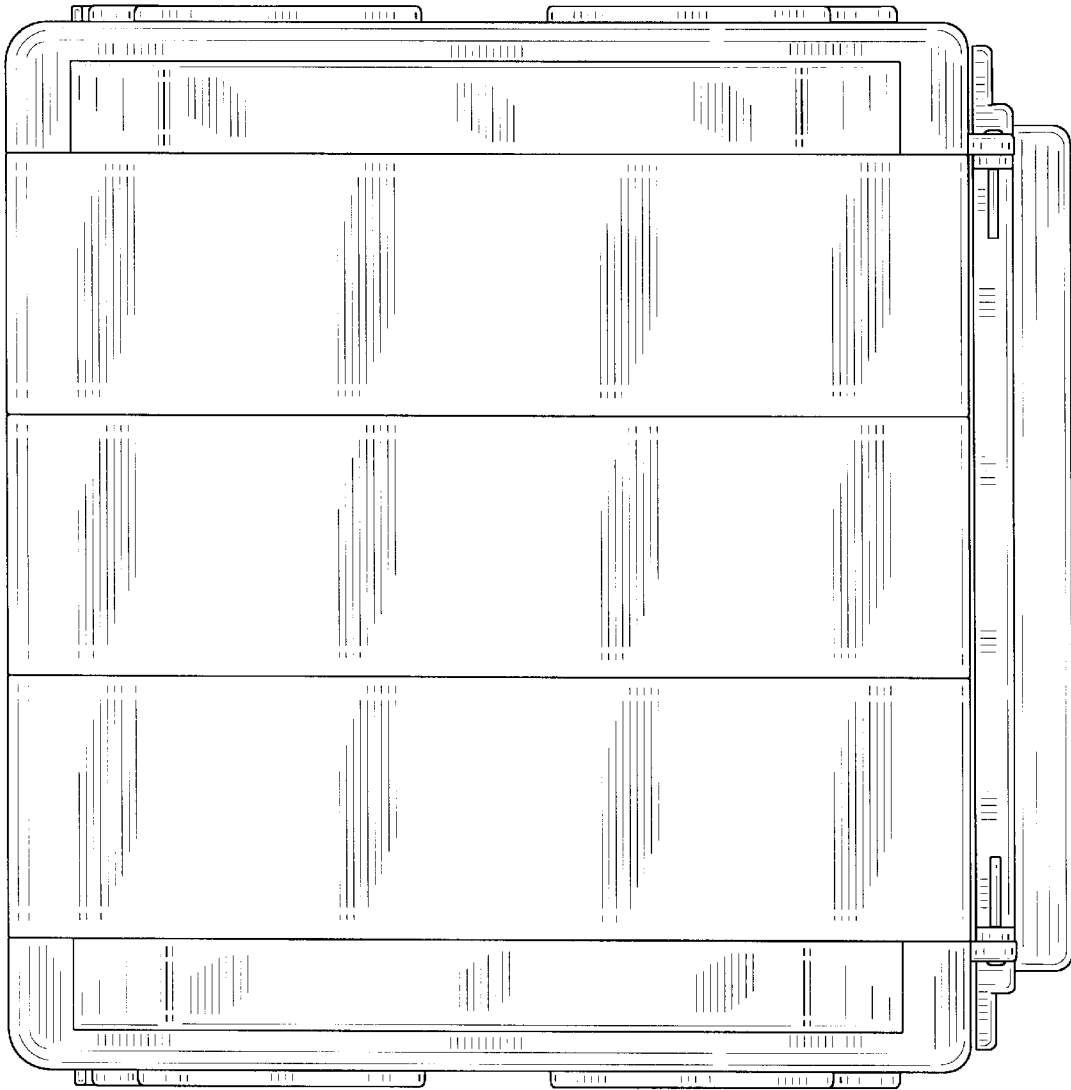

FIG. 17

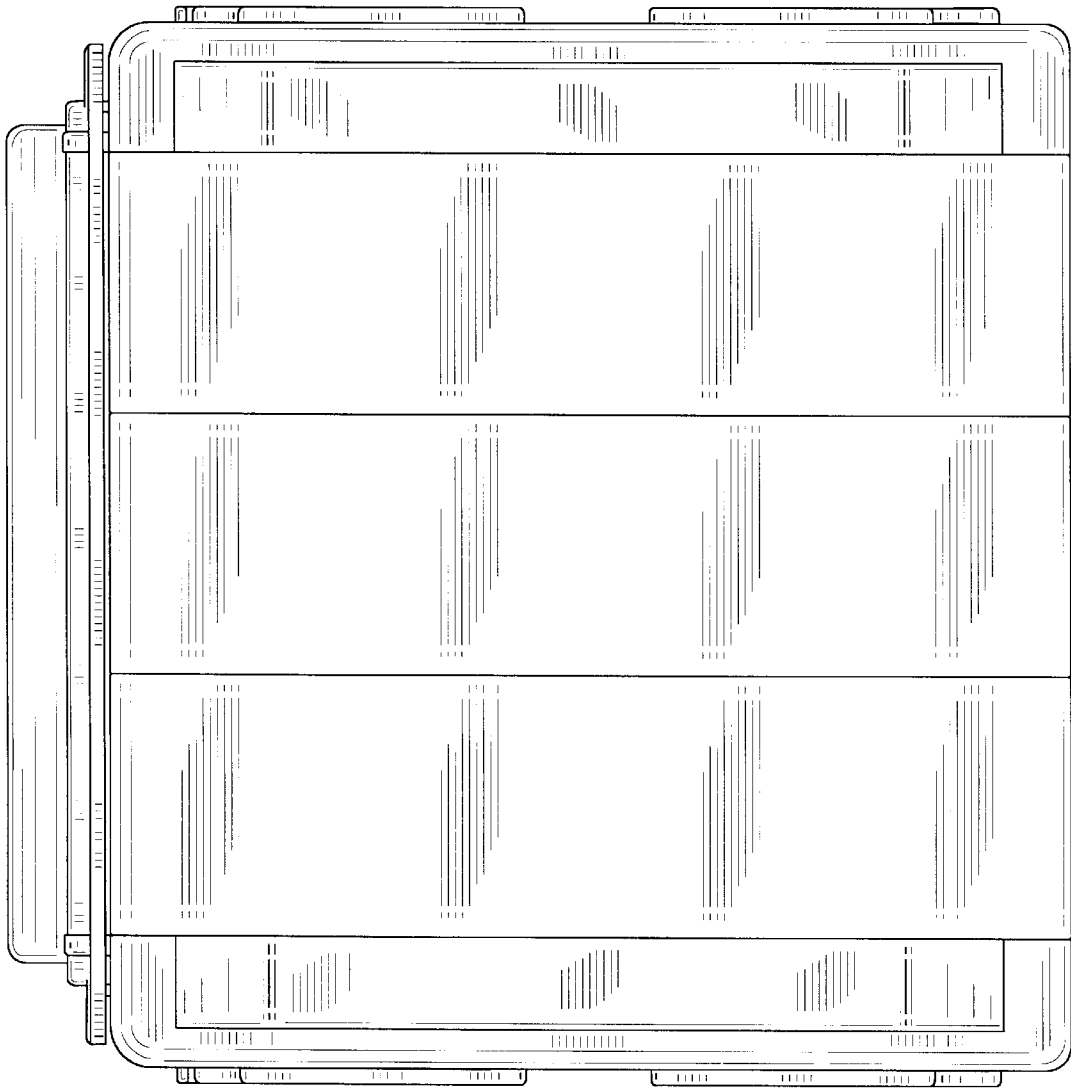

FIG. 18

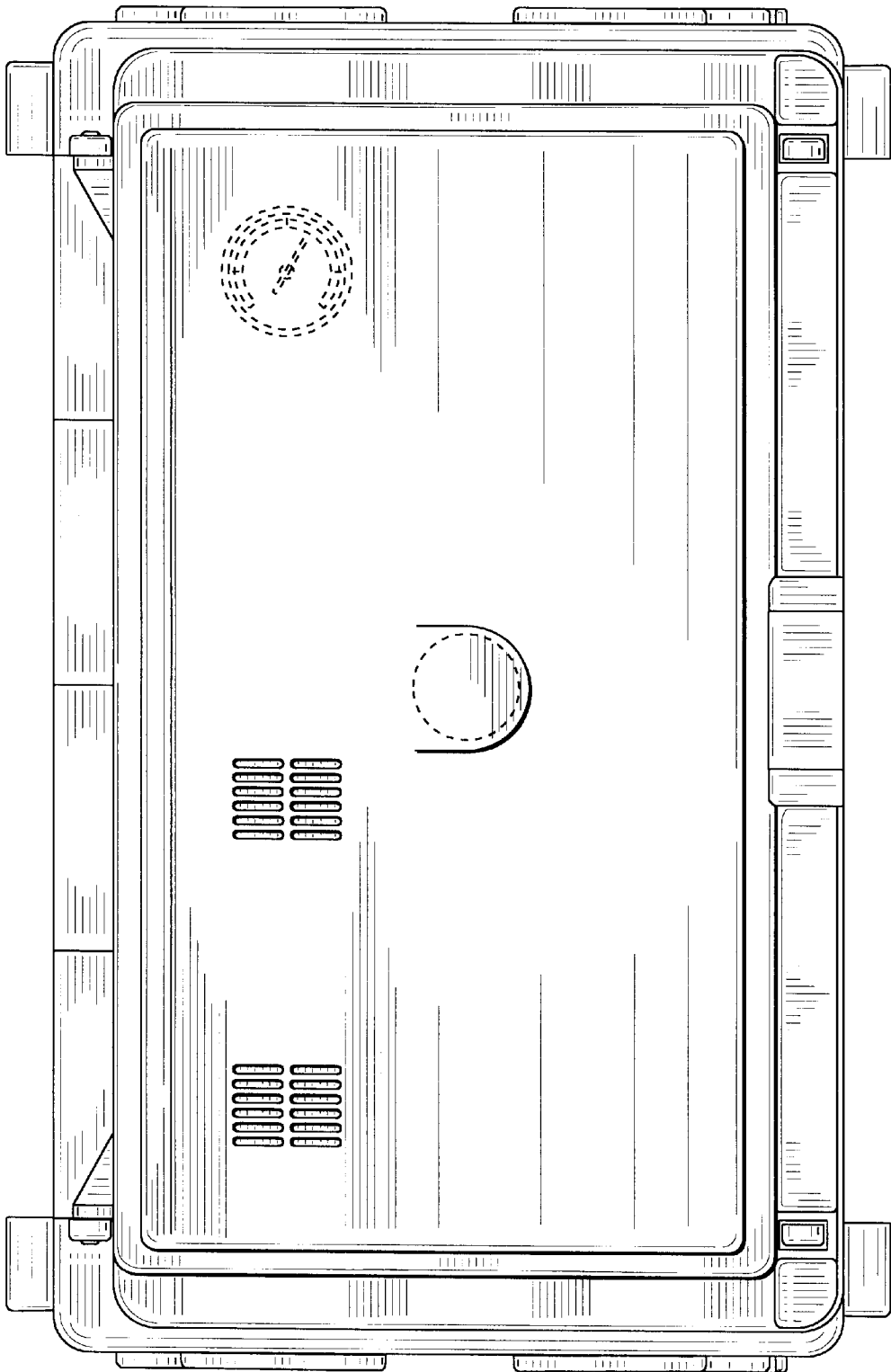

FIG. 19

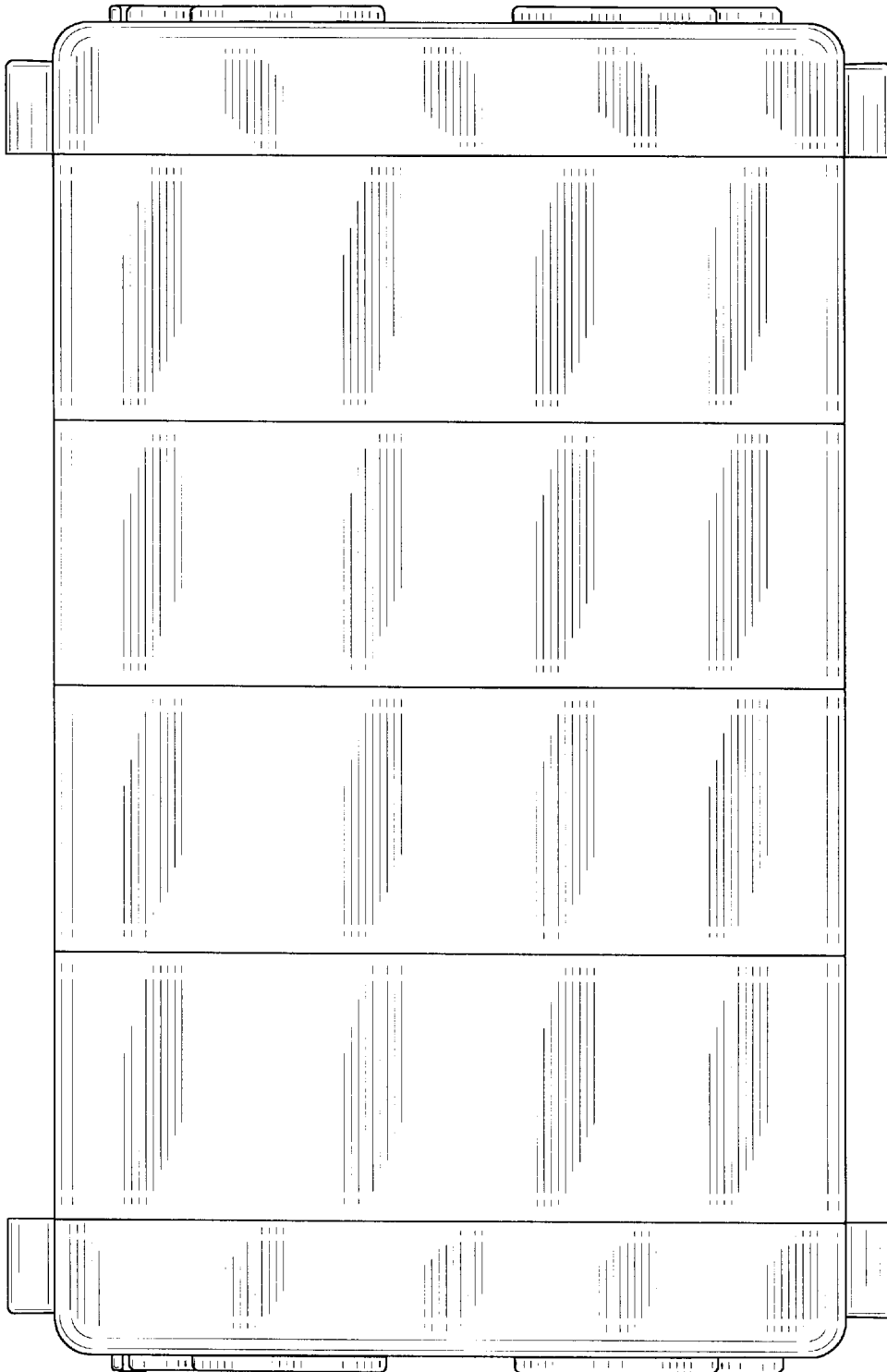

FIG. 20

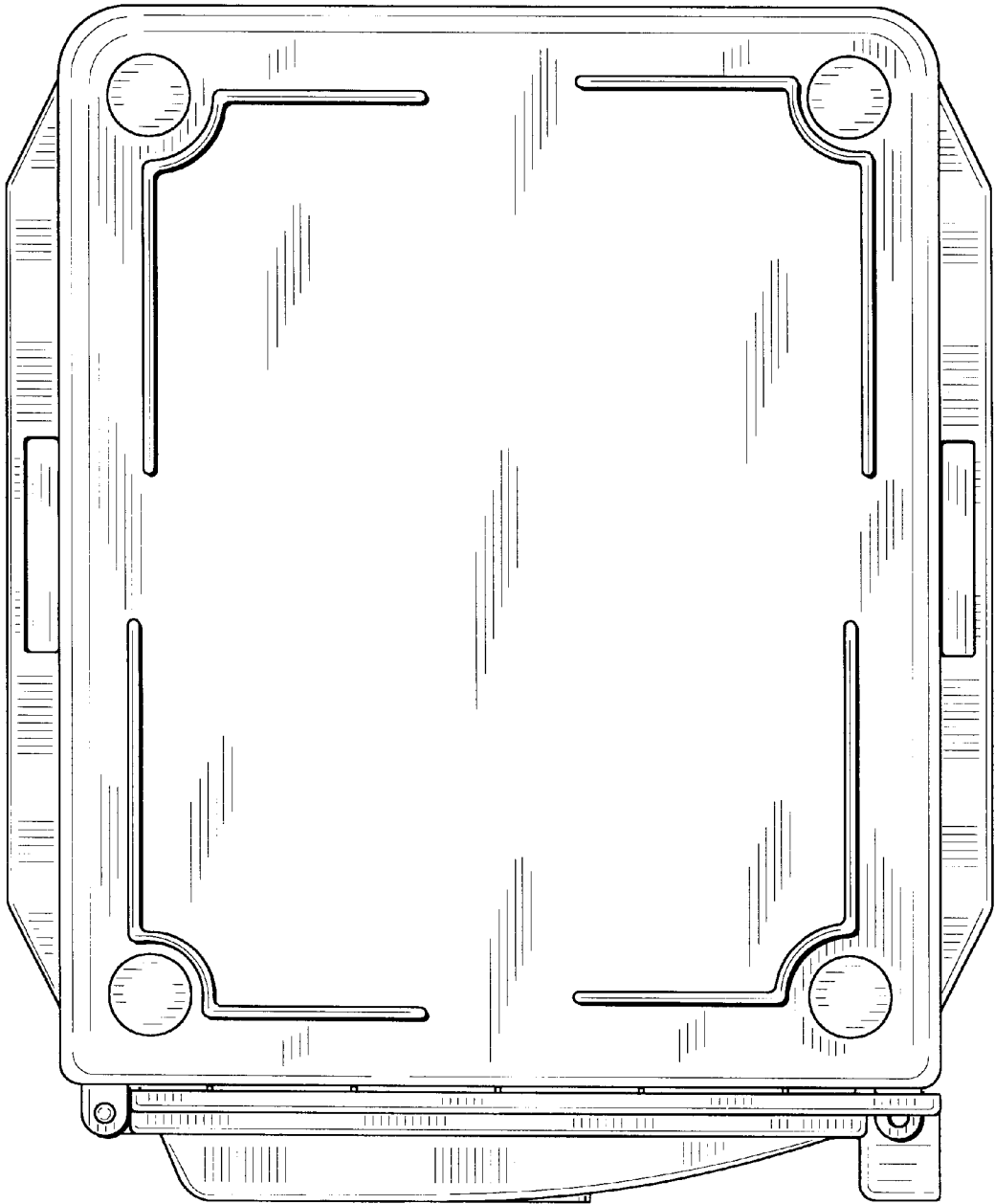

FIG. 21

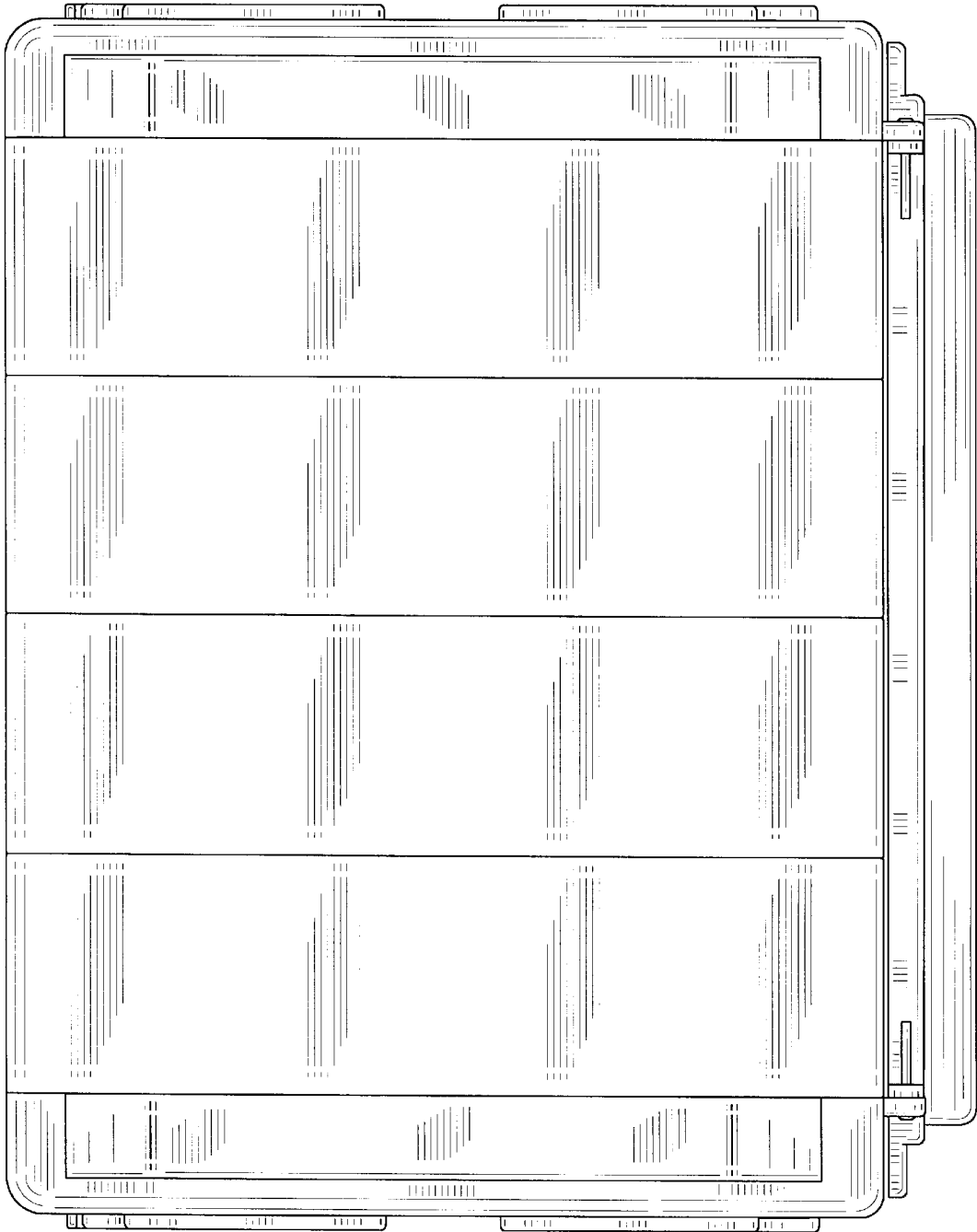

FIG. 22

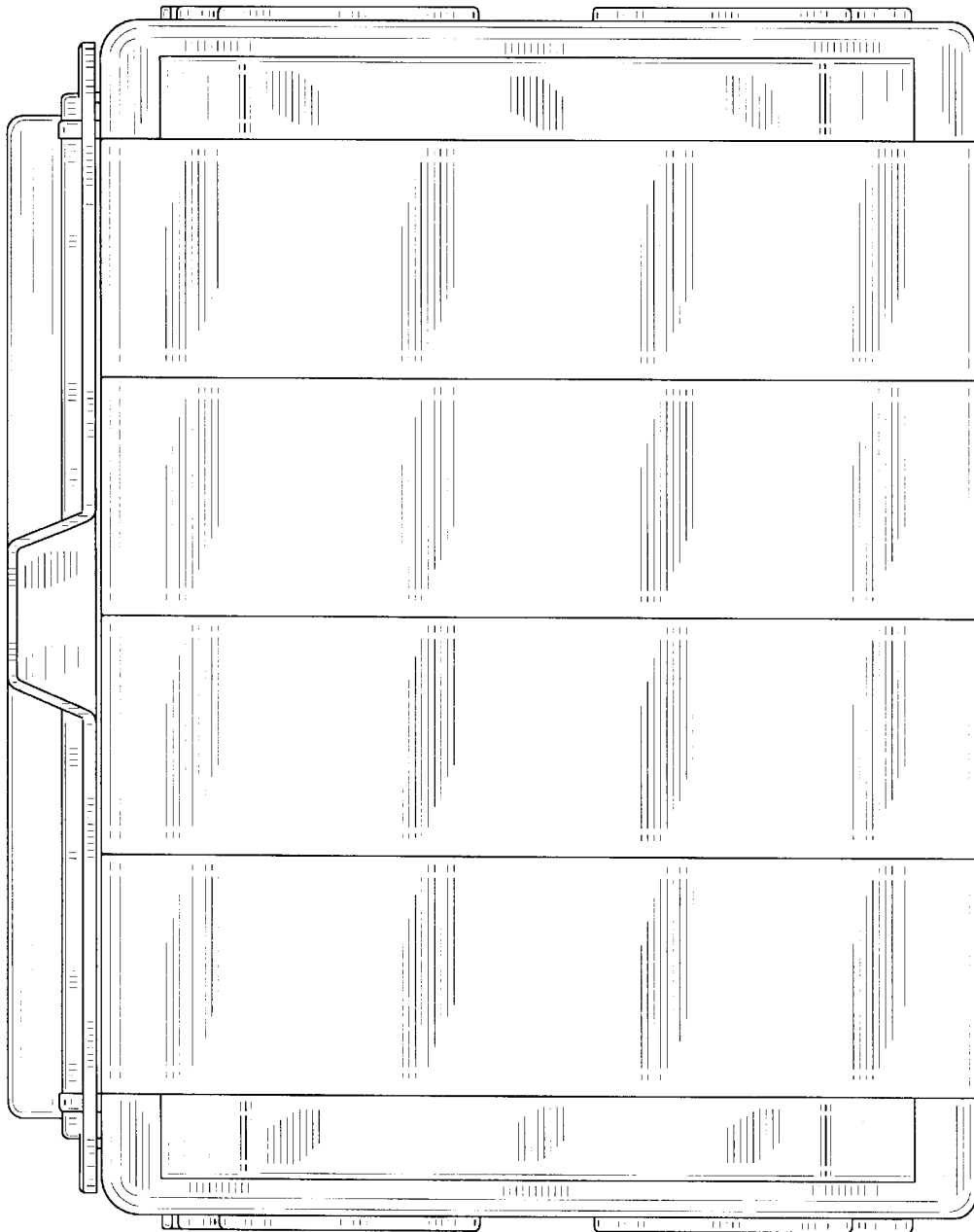

FIG. 23