



(12) PATENT ABRIDGMENT (11) Document No. AU-B-25382/95
(19) AUSTRALIAN PATENT OFFICE (10) Acceptance No 688049

- (54) Title
MULTIPLEX RECEIVER AND MULTIPLEX RECEIVING SYSTEM BROADCASTING
- International Patent Classification(s)
(51)⁶ **H04H 001/00 H04H 009/00**
- (21) Application No. : **25382/95** (22) Application Date **26.05.95**
- (87) PCT Publication Number : **WO95/33318**
- (30) Priority Data
- | (31) Number | (32) Date | (33) Country |
|-----------------|-----------------|-----------------|
| 6-115615 | 27.05.94 | JP JAPAN |
| 7-33602 | 22.02.95 | JP JAPAN |
- (43) Publication Date : **21.12.95**
- (44) Publication Date of Accepted Application : **05.03.98**
- (71) Applicant(s)
KABUSIKI KAISHA MEDIA MARKETING NETWORK
- (72) Inventor(s)
HIROMICHI SUZUKI
- (74) Attorney or Agent
WRAY & ASSOCIATES , PO Box 6292, Hay Street, EAST PERTH WA 6004
- (56) Prior Art Documents
JP 5-83216
JP 4-14918
- (57) Claim

1. A multibroadcast received for receiving an identification code related to the contents of a broadcasting program in a data signal carried by an information radio wave in a multibroadcasting radio wave and extracting information desired by an audience from the data signal, based on the identification code, comprising:

extracting means for extracting the identification code related to the contents of the broadcasting program from the data signal;

an insert portion for inserting therethrough a card with a predetermined identification code recorded thereon;

reading means for reading the identification code from the card inserted into said insert portion;

recording means for writing necessary information included in the data signal into the inserted card; and

(11) AU-B-25382/95
(10) 688049

-2-

control means for checking the identification code extracted from the data signal against the identification code read from the card, and controlling said recording means in accordance with the check result.



<p>(51) 国際特許分類6 H04H 1/00, 9/00</p>	<p>A1</p>	<p>(11) 国際公開番号 WO95/33318 (43) 国際公開日 1995年12月7日(07.12.95)</p>
---	-----------	--

<p>(21) 国際出願番号 PCT/JP95/01017 (22) 国際出願日 1995年5月26日(26.05.95) (30) 優先権データ 特願平6/115615 1994年5月27日(27.05.94) JP 特願平7/33602 1995年2月22日(22.02.95) JP (71) 出願人 (米国を除くすべての指定国について) 株式会社 メディア・マーケティング・ネットワーク (KABUSIKI KAISHA MEDIA MARKETING NETWORK)[JP/JP] 〒108 東京都港区白金6丁目14番15号 Tokyo, (JP) 8th Floor, (72) 発明者; および 1-6, Kojimachi, Chiyoda-Lu, Tokyo 102 Japan (75) 発明者/出願人 (米国についてのみ) 鈴木博道(SUZUKI, Hiromichi)[JP/JP] 〒228 神奈川県相模原市鞆野森2丁目11番9号 Kanagawa, (JP) (74) 代理人 弁理士 高月 猛(TAKATSUKI, Takeshi) 〒105 東京都港区虎ノ門3丁目1番10号 第2虎ノ門電気ビル 高月国際特許事務所 Tokyo, (JP)</p>	<p>(81) 指定国 AU, BG, BR, CA, CN, CZ, FI, HU, JP, KE, KR, MX, NO, NZ, PL, RO, RU, SK, US, VN, 欧州特許(AT, BE, CH, DE, DK, ES, FR, GB, GR, IE, IT, LU, MC, NL, PT, SE). 添付公開書類 国際調査報告書 </p>
--	--

(54) Title : MULTIPLEX RECEIVER AND MULTIPLEX RECEIVING SYSTEM BROADCASTING

(54) 発明の名称 多重放送受信装置及び多重放送受信システム

(57) Abstract

A multiplex receiver comprises a stereophonic receiving section (4), a code extractor section (7) which extracts such information as the identification code related to the contents of a broadcasting program and necessary character codes from data signals contained in broadcast radio waves, a printing section (10) which records information extracted from the section (7), a slot (12) for inserting a card (11), a reading section (13) which reads a prescribed identification code recorded on a card (11) inserted into the slot (12), and a control section (8) which collates the identification code recorded on the card (11) with an identification code from the section (7) and records necessary information contained in the data signals on the card (11) by operating the printing section (10) in accordance with collated results. The control section (8) collates input data from a selectively provided key input section (16) with prescribed data from the code extractor section (7)

- | | |
|--------------------------------------|-------------------------------|
| 2 ... FM tuner | 9 ... displaying section |
| 3 ... audio amplifier | 10 ... printing section |
| 4 ... stereophonic receiving section | 11 ... card |
| 5 ... L-MSK demodulator | 12 ... card inserting section |
| 6 ... error correcting decoder 6 | 13 ... reading section |
| 7 ... fetching section | 16 ... key input section |
| 8 ... control section | M ... storing section |

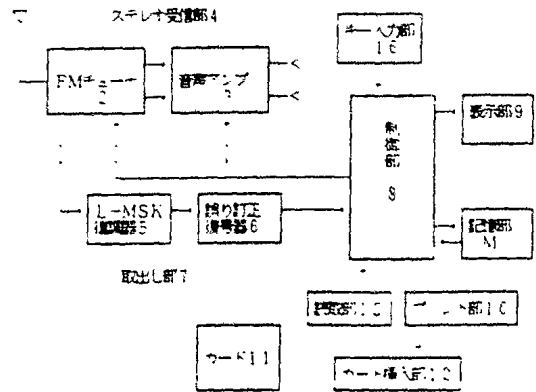

DESCRIPTION

MULTIBROADCAST RECEIVER AND MULTIBROADCAST RECEIVING SYSTEM

TECHNICAL FIELD

The present invention relates to a multibroadcast receiver with a card, and to a multibroadcast receiving system capable of more effectively utilizing a radio massmedia system with a card as a medium between the audience side and the broadcasting station side.

BACKGROUND ART

A radio massmedia system using a normal broadcast receiver such as a television, a radio or the like basically provides information through a unilateral or unidirectional communication made from a broadcasting station or a program sponsor (hereinafter called "broadcasting station side") to an audience/listener (hereinafter called "audience side"). It is necessary for the broadcasting station side to continue to send information to many and unspecified persons or parties at all times while whether or not the viewers are watching and listening in fact, remains unknown. Further, the audience side must select necessary information from random and massive amounts of information given by broadcasting. Therefore, the degree of information transfer to the audience side can be actually said low. The broadcasting station side repeatedly sends increasingly massive amounts of information to the audience side to overcome the low degree of information transfer, thereby causing a vicious circle that a further increase in labors or trouble occurs to select information. Thus, the broadcasting station side incurs a result that even when the amount of information to be given is increased, commercial effects which are commensurate with that cannot be

achieved.

A broadcast for transmitting a digital data signal using a multibroadcasting radio wave or PCM broadcasting radio wave used for a television and a radio has been recently put to practical use. This type of broadcast is of a system capable of simultaneously transmitting ~~additive~~ information based on the digital data signal together with a general broadcasting program and has a potential that a problem developed due to the unidirection of the aforementioned information transfer can be reduced by using such ~~additive~~ information.

The present invention has been made from the foregoing points of view, and it is an object of the present invention to solve the aforementioned problems developed in radio mass media, i.e., the increase in trouble incident to the selection of information and the decrease in commercial effects due to the reduction in the degree of information transfer by effectively utilizing a multibroadcasting system.

DISCLOSURE OF THE INVENTION

In order to achieve the above object, the present invention provides a multibroadcast receiver for ~~including~~ ^{receiving} an identification code related to the contents of a broadcasting program in a data signal carried by an ~~additive~~ information radio wave in a multibroadcasting radio wave and extracting information desired by an audience from the data signal, based on the identification code, comprising:

means for extracting the identification code related to the contents of the broadcasting program from the data signal;

a portion for inserting therethrough a card with a predetermined identification code recorded thereon;

means for reading the identification code from the card inserted into



the insert portion;

recording means for writing necessary information included in the data signal into the inserted card; and

control means for checking the identification code extracted from the data
5 signal against the identification code read from the card and controlling the recording means in accordance with the check result.

Further, the present invention provides a broadcast receiving system comprising:

a broadcasting station for including an identification code related to the
10 contents of a broadcasting program in a data signal carried by an information radio wave in a multibroadcasting radio wave and broadcasting the same;

a card having the identification code recorded thereon in advance;

a multibroadcast receiver having an insert portion for inserting the card
therethrough and constructed so that information necessary to identify the
15 contents of the broadcasting program is extracted from the data signal and is recorded on the card, based on the identification code recorded on the card; and

card recovery locations scattered within a broadcasting area so as to recover the card;

whereby high value-added information or physical services such as a
20 premium, present, etc. are provided at the card recovery locations based on the records on the card, while the records on the card which are collected through the card recovery locations are used for statistical processing.

The multibroadcasting receiver and multibroadcast receiving system can be used as described below and can reduce labors made when the audience side
25 selects information, according to the way of using them.



A card on which an identification code corresponding to "Artist name", for example, is recorded is inserted into the insert portion of the multibroadcast receiver. When the card is inserted into the insert portion, the reading means reads the identification code from the card. The extracting means of the multibroadcast receiver takes out the identification code (which is transmitted so as to be included in a broadcasting radio wave as a data signal in unison with a piece of music being on air by a broadcasting station) corresponding to the artist name from the data signal in the multibroadcasting radio wave. The control means checks the identification code read from the card against the identification code taken out of the data signal in the radio wave. When the identification codes coincide with each other, the usage of the multibroadcast receiver and the multibroadcast receiving system is made possible that, for example, information (e.g., entertainment information about a singer, words of a song, etc.) about music being on air at that time from the data signal carried by the ~~additive~~ information radio wave along with the identification code of the artist name is recorded on the card inserted into the insert portion (as an alternative to the recording of the information on the card, a character code sent as a data signal may be printed in the form of characters or magnetically recorded).

Similarly, a card having a predetermined identification code obtained by combining a "traffic information program code" and a "by-geographic area/by-route code" together is inserted into the insert portion. A traffic information program included in the data signal in the multibroadcasting radio wave is checked against an identification code related to a by-geographic area/route to thereby limitatively receive traffic information about a predetermined area only. As a result, the received traffic



information can be recorded on the card. When the audience is scheduled to buy certain merchandise, a card having an identification code related to the merchandise, e.g., "merchandise commercial classification code" is inserted into the insert portion. The above "merchandise commercial classification code" is included in the data signal in the multibroadcast radio wave so as to correspond to a broadcasted commercial. Similarly to the above, the identification code taken out by the extracting means is checked against the identification code read by the reading means. When they coincide with each other, the usage of the multibroadcast receiver and the multibroadcast receiving system is made possible that, for example, detailed information about the usage, price and selling locations of merchandise advertised at that time from the data signal carried by the additive-information radio wave along with the "merchandise commercial classification code", is recorded on the card.

Namely, when they are used in this way, the audience can automatically take out his/her desired information from random and massive amounts of information by simply selecting a card having an identification code that satisfies his/her own desire and inserting it into the multibroadcast receiver. It is therefore possible to save labors or efforts required to select the information. Since the taken-out information is recorded on the card, the audience can carry the information and re-use it whenever they like.

On the other hand, if a predetermined identification code fit for the purpose of the broadcasting station side is recorded on a card and the card is distributed to the audience side, then the broadcasting station side can substantially broadcast to a limited audience. One example will be described. A program or advertisement sponsor distributes cards each having an identification code corresponding to its own company, e.g., a "sponsor code"

recorded thereon, to the audience side in advance. The sponsor ties up with the broadcasting station so that the "sponsor code" is broadcasted simultaneously with a program or commercial thereof with the "sponsor code" included in a data signal. Thus, the multibroadcast receiver and the multibroadcast receiving system can provide the usage that when both identification codes coincide with each other in the same manner as described above, the sponsor provides only the audience having the cards with advantageous information such as new-product information, a discount price, the term of a discount sale, etc. Namely, the broadcasting station side can restrict suitable commercials only to persons who often watch the program or commercial for the sponsor or to persons who use the sponsor's goods habitually.

Similarly, for example, such contents as a man in his twenties whose hobby is skiing are coded and recorded on a card as a "age/sex/hobby limitation code". The broadcasting station side distributes the card to the audience side in advance. Thus, the multibroadcast receiver and the multibroadcast receiving system can provide the usage that, for example, a company for selling ski goods cooperates with a broadcasting station so that the broadcasting station broadcasts a commercial about the ski goods along with a data signal including the above identification code therein. Namely, since the company can advertise the ski goods intended for only persons who consider skis as hobbies, a higher commercial effect can be expected.

Further, cards having a "XX fan-club membership code" and a "XX company staff code" recorded thereon as identification codes are distributed to members of a fan club or staffs of a special enterprise in advance. Thereafter, detailed information is recorded on the corresponding card through the multibroadcast receiver in which the card having the

identification codes has been inserted. In some cases, the reception and reproduction of a general broadcast can be controllably constituted. Thus, the broadcasting station side can substantially realize a private broadcast.

In using the multibroadcast receiver according to the present invention, the broadcasting station side may tie up with a number of convenience stores in a broadcasting area so as to provide card recovery locations. Namely, a file server is disposed in each card recovery location so that information unable to be directly recorded or recorded on a card is secondarily recorded or printed out on the card by using the file server.

Namely, for example, a "pamphlet desired code", a "by-geographic area/by-route code", etc., each of which indicates an output instruction made to the server, are set so as to be included in a data signal carried by an ~~additive~~ information radio wave in a multibroadcast radio wave. When a certain program or commercial is received based on a predetermined identification code recorded on a card and necessary information is taken out from the data signal so as to be recorded on the card again, the aforementioned "pamphlet desired code" and "by-geographic area/by-route code" are also recorded on the same card along with the necessary information. Next, the audience brings the card to its corresponding card recovery location where the "pamphlet desired code" and "by-geographic area/by-route code" are read by a suitable reader. Thereafter, a merchandise pamphlet and a road map displayed with color images, for example, are outputted from the corresponding file server.

Thus, the card on which the identification code related to the broadcasting program is recorded from the data signal in the multibroadcast radio wave by the multibroadcast receiver, can be regarded as evidence (audiovisual certification) that the audience was really watching or



listening to a broadcasting program. Thus, if the card is recovered by a suitable method such as mailing or the like and the contents recorded on the card are confirmed at the card recovery location, then high value-added information, e.g., valuable physical service such as a premium, a sample, a benefit, a square piece of fancy paper, a concert ticket, etc. can be easily offered only to the persons who was really watching or listening to the broadcasting program.

Namely, when a certain sponsor invites an application to the audience for providing the audience with a sample or present during a broadcasting program, the sponsor cannot exclude persons who do not really watch or listen to the program from making applications or one person from making a plurality of applications. However, the sponsor can strictly select one of applicants by using a card as an audiovisual certification.

Another advantage of the card that serves as the audiovisual certification is that various data recorded on the card can be used for an audience trend survey (such as an audience rating of a program, seizing of distribution of an audience age group, an audience preference survey or the like).

The following usage is also made possible if an external input means is further added to the above multibroadcast receiver and the control means performs control for checking data input from the external input means against predetermined data included in a received data signal and recording necessary information taken out of the data signal on a card in accordance with the result of check.

Namely, for example, a broadcasting station provides quizzes through a broadcasting program for a radio or television and sends a correct answer to the each quiz through a data signal. Thus, the usage is made possible that



the audience checks his answer input through the external inputting means against the correct answer to the quiz and the result of check is recorded on a card for display.

In doing so, various uses that, for example, the audience can recognize a correctness or incorrectness relative to the answer to the set quiz substantially in real time and the audience can bring the card to the card recovery location to receive the premium, can be realized, thereby making possible to provide a very interesting broadcasting program capable of arousing the interest of the audience.

Further, the following usage is also made possible, if a write instruction signal and a read instruction signal for the recording means and the reading means are included in a data signal carried by an additive-information radio wave sent from a broadcasting station; and the control means controls the recording means and the reading means in accordance with the write and read instruction signals to perform the reading and writing of information from and into a card.

Namely, after a quiz has been set through a broadcasting program, the broadcasting station sends the write instruction signal after the elapse of a predetermined time interval so that the multibroadcast receiver temporarily records an audience answer issued from the external inputting means on the card. Next, the broadcasting station sends a correct answer to the quiz and transmits the read instruction signal to allow the reading means to read the audience answer so as to be checked against the above correct answer.

In doing so, the broadcasting station side can actively restrict the time (answer reception time) between setting and answering the quiz. Thus, the broadcasting station side can provide a quiz program at quick tempo in

unison with the program progress. Further, after an audience answer issued from the external input means has been temporarily recorded on a card by a certain multibroadcast receiver, the audience brings the card to other multibroadcast receiver where the correctness or incorrectness relative to the answer to the quiz can be confirmed. Thus, the usage is made possible that the audience makes an answer to a quiz at his/her own house in the morning and the correctness or incorrectness relative to its answer is confirmed at the workplace in the noon recess.

The above usage can be applied to the guess of the issue about matches such as baseball, basket, soccer, etc., replies submitted to a questionnaire and applications for a premium, a ticket, various samples, a benefit, etc., as well as to the setting of quizzes. Alternatively, the usage can be applied to an audience entry-type game by suitably varying the contents of a message printed on a card based on data given from an external input means. Further, various uses such as a radio-television shopping program, an educational program, etc. can be considered.

The following are considered as the recording of the information on the card according to the above usage. Namely, the information is magnetically or electrically recorded on a pet card or an IC card. Alternatively, the information is printed out onto a card such as paper by using a callular code, a bar code or characters. The former is desirable in that the information storage capacity per unit area of the card can be made great, whereas the latter is desirable in that the manufacturing cost of the card is cheap and the contents recorded on the card are visible to the naked eye.

BRIEF DESCRIPTION OF THE DRAWINGS

Fig. 1 is a perspective view showing a first embodiment of a multibroadcast receiver according to the present invention;

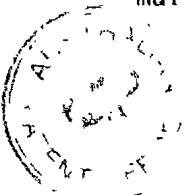

Fig. 2 is a block diagram showing the first embodiment according to the present invention;

Fig. 3 is a view showing a state prior to the use of a card employed in the first embodiment;

Fig. 4 is a view showing a state subsequent to the use of the card employed in the first embodiment;

Fig. 5 is a view showing a modification of the card employed in the first embodiment;

Fig. 6 is a perspective view showing a second embodiment of a multibroadcast receiver according to the present invention;

Fig. 7 is a block diagram showing the second embodiment according to the present invention;

Fig. 8 is a view showing a card employed in the second embodiment shown in Fig. 6;

Fig. 9 is a view showing another example of the card employed in the second embodiment; and

Fig. 10 is a flowchart for explaining one example of how to use the second embodiment.

BEST MODE FOR CARRYING OUT THE INVENTION

[First embodiment]

A first embodiment according to the present invention will be described with reference to Figs. 1 through 5. As shown in Figs. 1 and 2, a multibroadcast receiver 1 according to the present invention comprises a stereo receiving unit 4, an extractor 7, a controller 8, a display 9, a print unit 10, an insert portion 12 for inserting a card 11 therethrough, a reader 13 and an unillustrated memory.

The stereo receiving unit 4 receives a broadcasting wave by an FM tuner

2 and outputs sound or voices from a speaker through an audio amplifier 3. The extractor 7 takes out necessary data included in a binary data signal carried by an additive-information radio wave in the multibroadcasting wave. The extractor 7 comprises an L-MSK demodulator 5 (Level Controlled Minimum Shift Keying; digital modulation system for varying a multilevel according to a modulation factor of a stereo difference signal) and an error correcting decoder 6. The controller 8 processes an identification code related to the contents of a broadcasting program extracted from the extractor 7, various control signals and signals inputted from other peripheral devices, converts them into predetermined character codes or control codes and performs necessary various controls on peripheral devices. The display 9 uses a liquid crystal display element and suitably displays necessary information under the control of the controller 8. The print unit 10 is composed of a thermal printer and receives necessary data from the controller 8 so as to print it on the card 11 inserted into the insert portion 12. The insert portion 12 is used to insert the card 11 to be described later therethrough and is selectively provided with a sensor for detecting whether the card 11 exists. The reader 13 is composed of an optical reader, which reads an identification code on the card 11 in the insert portion 12 and sends it to the controller 8.

As shown in Fig. 3, the card 11 is shaped in the form of a thin plate-like card printable by the print unit 10. A hexadecimal 4-digit callular code 14 is printed on an upper stage of the card 11 as an identification code. The callular code 14 is read when inserted into the insert portion 12 and is stored in an unillustrated memory by the controller 8. Further, a recording space S for printout of the print unit 10 is provided at a lower stage of the card 11. The recording space S is of a recording space for printing

characters (such as a program name, a quiz name, the date and hour of a broadcast) related to the contents of a program taken out of a data signal in the broadcasting wave and callular codes 15 indicated by coded identification codes, such as instructions for outputting words relative to a file server located in a card recovery location, etc.

Although not shown in Fig. 3 nor 4, a postcard form or format having a space for entering an address and characters is printed on the reverse side of the card 11 so as to facilitate mailing the card from an audience to a broadcasting station or vice versa. The size of the card 11 is set to the order of that of the postcard as shown in Fig. 5. About the half of the card 11 is inserted into the insert portion 12, whereas the other half may be used as a space for entering characters or an advertisement space for a sponsor.

Incidentally, the callular codes 14 and 15 may be printed on the card 11 by magnetic ink or special ink so as to prevent unauthorized usage of the card 11. The callular codes 14 and 15 are illustrated as the 4-digit codes. However, they are suitably set as 5-digit or more codes according to the magnitude of an audible broadcasting area, the number of audience or the quantity of information to be included.

The way of using the multibroadcast receiver 1 will now be described. An identification code corresponding to a certain specific singer is printed on the card 11 as the callular code 14 in advance.

When the card 11 is inserted into the insert portion 12 in a state in which a power switch (not shown) is being turned ON, the reader 13 located in the position corresponding to the card 11 reads the callular code 14 and sends the result of reading to the controller 8. The controller 8 converts the input into checkable identification data by referring to a conversion

table and the identification data is suitably stored in the memory.

The extractor 7 takes out an identification code related to the contents of a broadcasting program included as header information indicative of a data signal in the multibroadcasting wave and sends it to the controller 8. The controller 8 checks the identification code supplied from the extractor 7 against the identification code stored in the memory. When they coincide with each other (they may be made inconsistent with each other according to the condition), the controller 8 receives predetermined data in a general-purpose data area, which is sent subsequently to the header, from the extractor 7 and causes the print unit 10 to print the data within the recording space 5 on the card 11 in the form of the characters and the callular code 15.

Thus, when the card 11 is set in the insert portion 12 of the multibroadcast receiver 1, the audience can automatically print necessary data on the card 11 when a piece of music sung by a specific singer is played on air. Further, the audience refers to the card 11 at the card recovery location as needed and acquires entertainment information about the specific singer or words from the file server based on the callular code 15. In the illustrated embodiment, the contents recorded on the card 11 include characters for identifying a program and instructions for outputting words to the file server. However, character codes indicative of words may be included in the general-purpose data area so that the words are directly set out on the card 11.

The data signal employed in the present embodiment is constructed with a bit string composed of, for example, 16Kbps as one group and includes identification codes related to the contents of a broadcasting program, numerical data, text data, graphic-element (mosaic set for map drawing) data,

other additive information, and the like are included in an information word area of 6.83Kbps excluding a check word area of 9.17Kbps. The data signal is multiplexed at the broadcasting station so as to be transmitted synchronously with the progression of a normal broadcasting program.

[Second embodiment]

A second embodiment will now be described with reference to Figs. 6 through 10. As is understood from Figs. 6 and 7, a key input unit 16 used as an external inputting means is added to the second embodiment in addition to the structure of the first embodiment. In the figure, the key input unit 16 is directly mounted on the upper surface of a multibroadcast receiver 1. However, the key input unit 16 may be connected to a controller 8 so as to be able to perform remote control using infrared rays, a weak radio wave, etc. Incidentally, a memory M is simply shown in the second embodiment although not shown in the first embodiment.

As shown in Figs. 8 and 9, a card 17 is basically identical to the card 11 employed in the first embodiment. A callular code 18 equivalent to the callular code 14 employed in the first embodiment is recorded on an upper stage of the card 17. A recording space (not shown) for printing of a print unit 10 is provided at a lower stage of the card 17 in the same manner as the first embodiment. When the card 17 is inserted into an insert portion 12, callular codes 19 corresponding to the callular codes 15 employed in the first embodiment are printed on the recording space. The callular codes 19 include data input from the key input unit 16 as will be described later. A callular code 20 provided at the lowest stage of the recording space will be described later.

One example of the way of using the second embodiment will now be described with reference to Fig. 10. A program identification code for

identifying a broadcasting program called "XX quiz" is printed on the card 17 in advance as the callular code 18. When the card 17 is first inserted into the insert portion 12 in an ON state of a power switch as the preceding stage, a reader 13 located in a position corresponding to the card 17 reads the callular code 18 and sends the result of reading to the controller 8. The controller 8 converts the read information into checkable identification data by using a conversion table or the like and allows the converted data to be stored in the memory M. Further, the controller 8 recognizes that the data is of identification data for a quiz program and enters into an external input reception mode.

An extractor 7 takes out a program identification code (corresponding to the identification code associated with the "XX quiz" in the present embodiment) related to the contents of a broadcasting program included as a header for a data signal in a multibroadcasting wave and sends it to the controller 8. The controller 8 checks the identification code taken out from the extractor 7 against the identification code stored in the memory M. When they coincide with each other, the controller 8 suitably performs receiver control (setup) such as an increase in volume or sound level and is thereafter brought into an input standby state S1.

The proceeding of the controller 8 to the input standby state S1 can be executed by various methods. The controller 8 may be manually shifted to the input standby state S1 by an additionally-provided switch, for example. Alternatively, the controller 8 may be automatically shifted to the input standby state S1 simultaneously with the turning ON of the power. Further, an instruction signal for a shift to an external input reception mode is included in predetermined data within the general-purpose data area, which is sent subsequently to the header. When the shift instruction signal is

taken out through the extractor 7 subsequently to the header in this state, the controller 8 may be caused to control the shift to the input standby state.

Next, when the controller 8 is in the input standby state S1, for example, a quiz is set during a broadcasting program and an audience is urged to answer by numbers using the key input unit 16 (S2). When, for example, "3" in the key input unit 16 is pressed (S3), it is checked whether "3" is a key input signal (S4) and "3" is displayed on the display 9 as an answer (S5). When a confirmation or acknowledge button of the key input unit 16 is next depressed (S6), the data indicative of "3" is stored in the memory 15 through the controller 8 (S7) and the controller 8 returns to the input standby state S1.

After the elapse of a predetermined time (i.e., after a time required to restrict the answer to the quiz has elapsed), a broadcasting station sends a print instruction signal (write instruction signal) (S8). When the print instruction signal is taken out from the data signal in the multibroadcasting wave through the extractor 7 in the input standby state S1 (S9), it is checked whether the record of the answer stored in the state S7 exists (S10). If the answer is found exist at S10, then random-number data "1" sent subsequently to the print instruction signal from the broadcasting station is added to the data indicative of "3" taken out from the memory 15 (S11 and S12). As shown in Figs. 3 and 4, the character information sent subsequently to the random-number data from the broadcasting station and the callular code 19 indicative "4" are printed onto the card 17 (S13). When the above printing is finished, the controller 8 is brought into the input standby state (S1) again and the above operation is similarly repeated in unison with the progress of the broadcasting program.

Thereafter, the broadcasting station may send a read instruction signal

to the reader 13 (before the completion of a program or during other program after the completion of the program or during the same program as broadcasted a week later according to the contents of a quiz or the like) (S14). When the read instruction signal is received through the extractor 7 (S15), the controller 8 controls the reader 13 to read "4" of the callular code 19 printed on the card 17 (S16). The controller 8 receives a check or collation data signal indicating "4" (i.e., a correct answer) sent after the read instruction signal from the broadcasting station therein (S17) and checks it against the callular code 19 read at S16 (S18). The result of check is printed on the lowest stage of the recording space on the card 17 in the form of characters and a predetermined callular code 20 (S19), then the routine procedure is finished. Incidentally, the characters and the callular code 20 indicating the result of check (correctness or incorrectness relative to the answer) may be variously stored and suitably outputted by referring to the conversion table. Alternatively, they may be taken out from a data signal carried by an additive-information radio wave and then printed as necessary.

Thereafter, the audience brings the card 17 to card recovery locations scattered within a broadcasting area. Further, the audience allows a suitable reader disposed at each card recovery location to read the callular code 20 or presents characters indicative of the correctness or incorrectness relative to the answer to an employee, whereby the audience accepts physical services such as gifts, benefits, merchandise coupons, tickets, etc.

The second embodiment shows, as an example, the case where after the answer (S3) has been issued from the key input unit 16, the check data signal indicative of the correct answer is sent (S17). However, the following

procedure may be also considered. Namely, a check data signal is transmitted and stored in the memory M simultaneously with the setting of the quiz (S2). Further, a count-down start signal is sent to count the time that elapsed from the setting of a problem, on the multibroadcast receiver 1 side. After the elapse of a predetermined time interval, the answer given from the key input unit 16 is automatically checked against the check data stored in the memory M and the result of check is printed on the card 17. This can prevent such accidents that the state of a radio wave becomes worse after the setting of a quiz so that a print instruction signal cannot be received. Therefore such a problem as, "Although the quiz has been set, the time required to restrict the reception of an answer cannot be reliably set off" will be eliminated.

Even if the broadcasting station does not actively transmit the print instruction signal and the read instruction signal as in the second embodiment, the audience can check the answer to the quiz program, which is inputted by the use of the external inputting means 16, and can record the result of check on the card 17.

Briefly described, namely, the card 17 having the identification code for the quiz program is inserted into the insert portion 12 of the multibroadcast receiver 1 to thereby bring the controller 8 into the external input reception mode. The broadcasting station sends the identification code for the quiz program as header information and transmits it inclusive of the data indicative of the correct answer to the quiz within the general-purpose data area, which is sent subsequently to the header. The extractor 7 takes out the identification code related to the contents of the broadcasting program from the header information of the data signal in the multi-broadcasting radio wave, and sends the code to the controller 8. The

controller 8 checks the identification code taken out from the extractor 7 against the identification code stored in the memory M. When they coincide with each other, the controller 8 receives therein the data indicating the correct answer within the general-purpose data area sent subsequently to the header through the extractor 7 and checks the data against the data inputted from the key input unit 16. Finally, the result of check is printed onto the recording spaces on the card 17 through the print unit 10.

INDUSTRIAL APPLICABILITY

With the use of a multibroadcast receiver and a multibroadcast receiving system according to the present invention, as has been described above, a program and the contents of the program can be automatically selected based on an identification code recorded on a card so that necessary information can be recorded on the card. Therefore, the labor of selecting information can be saved and audio-visualized information can be easily stored. Further, the program can be broadcasted under the substantial limitations to an audience by distributing cards fit for the purpose of the broadcasting station side to the audience in advance. The recording of the information on the card can be utilized not only as an audiovisual certification for a broadcasting program but also as a statistical process such as an audience rating, a preference research of an audience, or the like. Since the audience can answer to a quiz or a questionnaire or the like by using an external inputting means, a more interesting program can be provided. Thus, both the audience side and the broadcasting station side can more effectively utilize the radio mass media.

The Claims defining the invention are as follows:

1. A multibroadcast receiver for receiving an identification code related to the contents of a broadcasting program in a data signal carried by an information radio wave in a multibroadcasting radio wave and extracting information desired by an audience from the data signal, based on the identification code, comprising:

extracting means for extracting the identification code related to the contents of the broadcasting program from the data signal;

an insert portion for inserting therethrough a card with a predetermined identification code recorded thereon;

reading means for reading the identification code from the card inserted into said insert portion;

recording means for writing necessary information included in the data signal into the inserted card; and

control means for checking the identification code extracted from the data signal against the identification code read from the card, and controlling said recording means in accordance with the check result.

2. A multibroadcast receiver according to claim 1, further comprising external input means and wherein said control means checks data inputted from said external means against predetermined data taken out of the data signal and records on the card the necessary information extracted from the data signal.

3. A multibroadcast receiver according to claim 2, wherein the data signal carried by the information radio wave in the multibroadcasting radio wave includes a write instruction signal and a read instruction signal, said recording means and reading means being controlled by said controlling means in accordance with the write instruction signal and the read instruction signal.



4. A multibroadcast receiver according to any one of claims 1 through 3, wherein said reading means comprises an optical reader, and said recording means comprises printer means and records the necessary information on the card by a two-dimensional code and characters.
5. A multibroadcast receiver according to any one of claims 1 through 3, wherein each of said reading means and said recording means comprises a magnetic reader recorder and the card is a magnetic recording card.
6. A multibroadcast receiver according to any one of claims 1 through 5, wherein said external input means is connected by wireless.
- 10 7. A multibroadcast receiver according to any one of claims 1 through 6, wherein the card has thereon a preliminarily-printed postcard format with a space for entering an address and characters.
8. A broadcast receiving system comprising:
- 15 a broadcasting station for including and broadcasting an identification code related to the contents of a broadcasting program in a data signal carried by an information radio wave in a multibroadcasting radio wave;
- a card having the identification code recorded thereon in advance;
- a multibroadcast receiver having an insert portion for inserting said card therethrough and constructed so that information necessary to identify the contents of the broadcasting program is extracted from the data signal and is recorded on said card based on the identification code recorded on said card;
- 20 and;
- card recovery locations scattered within a broadcasting area so as to recover said card;
- 25 whereby high value-added information or physical services such as a premium, present, or the like are provided at the card recovery locations based on the records on said card, while the records on said card which are

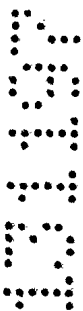
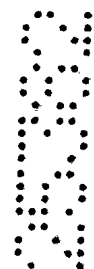

collected through the card recovery location, are used for statistical processing

9 A multibroadcast received substantially as hereinbefore described with reference to any one of the accompanying drawings.

5

Dated this THIRTEENTH day of NOVEMBER 1997

Kabushiki Media Marketing Network

Applicant

10 Perth, Western Australia
Wray & Associates
patent attorneys for the applicant

8

6
7
9



ABSTRACT

A multibroadcast receiver 1 comprises a stereo receiving unit 4, an extractor 7 for taking out information about an identification code related to the contents of a broadcasting program and a necessary character code or the like from a data signal in a broadcasting radio wave, a print unit 10 for recording the information extracted from the extractor 7 thereon, an insert portion 12 for inserting a card 11 therethrough, a reader 13 for reading a predetermined identification code recorded on the card 11 inserted in the insert portion 12, and a controller 8 for checking the identification code on the card 11 against the identification code extracted from the extractor 7 and recording by the print unit 10 the necessary information taken out of the data signal on the card 11 in accordance with the result of check. Further, the controller 8 checks data inputted through a selectively-provided key input unit 16 against predetermined data taken out from the extractor 7.

Drawings:

Figure 2:

- 2 ... FM tuner
- 3 ... audio amplifier
- 4 ... stereo receiving unit
- 5 ... L-MSK demodulator
- 6 ... error correcting decoder
- 7 ... extractor
- 8 ... controller
- 9 ... display
- 10 ... print unit
- 11 ... card
- 12 ... card insert portion
- 13 ... reader

Figure 3:

artist information card
(specified singer; Mr. XX)
(detailed information OP; words card)

Figure 4:

artist information card
(specified singer; Mr. XX)
(detailed information OP; words card)

- 94.05.05 song request
- 94.05.07 million quiz
- 94.05.10 Mr. XX DJ
- 94.05.17 Japan Pop Rock

Figure 5:

artist information card
(specified singer; Mr. XX)
(detailed information OP; words card)

- 94.05.05 song request
- 94.05.07 million quiz
- 94.05.10 Mr. XX DJ
- 94.05.17 Japan Pop Rock

Figure 7:

- 2 ... FM tuner
- 3 ... audio amplifier
- 4 ... stereo receiving unit
- 5 ... L-MSK demodulator
- 6 ... error correcting decoder
- 7 ... extractor
- 8 ... controller
- 9 ... display
- 10 ... print unit
- 11 ... card
- 12 ... card insert portion
- 13 ... reader
- 16 ... key input unit
- M ... memory

Figure 8:

- XX quiz entry card
- 94.06.18 first question answer 3
 - 94.06.18 second question answer 2
 - 94.06.18 third question answer 5

result of correctness or incorrectness correct answer 0

sorry to fail in quiz

please try next

Figure 9:

on-the-spot quiz application card

94.06.18 00xDPmatch

prospect of difference between runs scored

victory to home team due to two-run difference

top of third inning home run one

second at bat uniform number 3 one-base hit

fourth at bat uniform number 55 two-base hit

result of correctness or incorrectness bit hit!

drop in at closer

convenience store

right away

Figure 10:

start

set up multibroadcast receiver

<..... transmit program identification code

<---- card 17 (callular code 18)

S1 ... input standby state

S2 ... set problem in general broadcasting

program (input call)

S3 ... key input unit

S4 ... key input signal ?

S5 ... display answer

S6 ... acknowledge button ?
S7 ... store answer
S8 ... transmit print instruction signal
S9 ... Is print instruction signal received ?
S10 ... Is answer stored ?
S11 ... transmit random-number data signal
S12 ... add random number
S13 ... print answer
<----- card 17 (callular code 19)
S14 ... transmit read instruction signal
S15 ... Is read instruction signal received ?
S16 ... read card
card 17 (callular code 19) ----->
S17 ... transmit check data signal
S18 ... check
S19 ... print result of check
card 17 (callular code 20) <-----
End

第 1 図

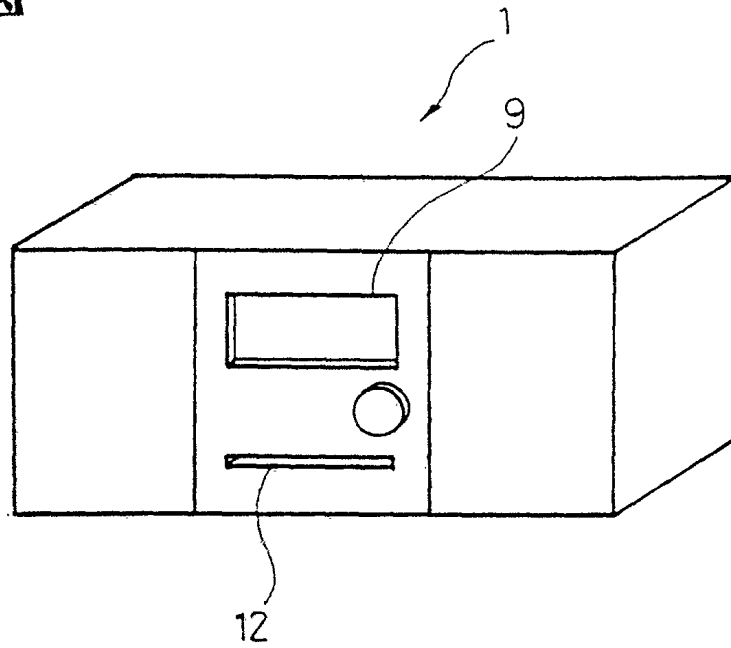

第 2 図

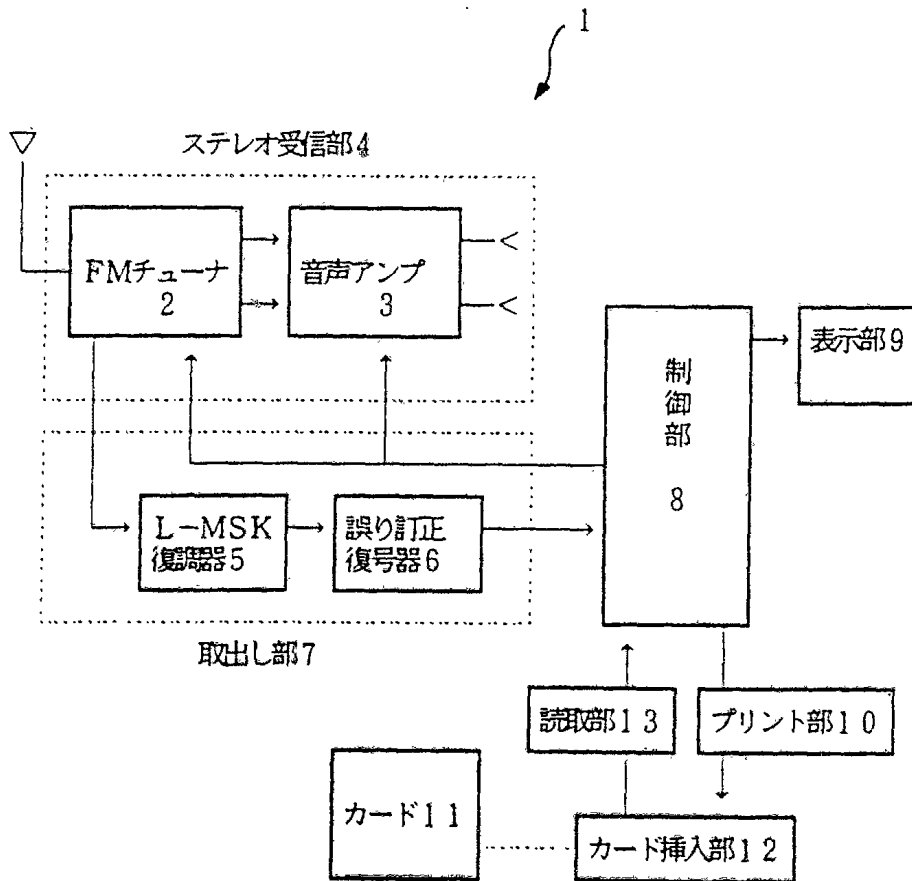

第 3 図

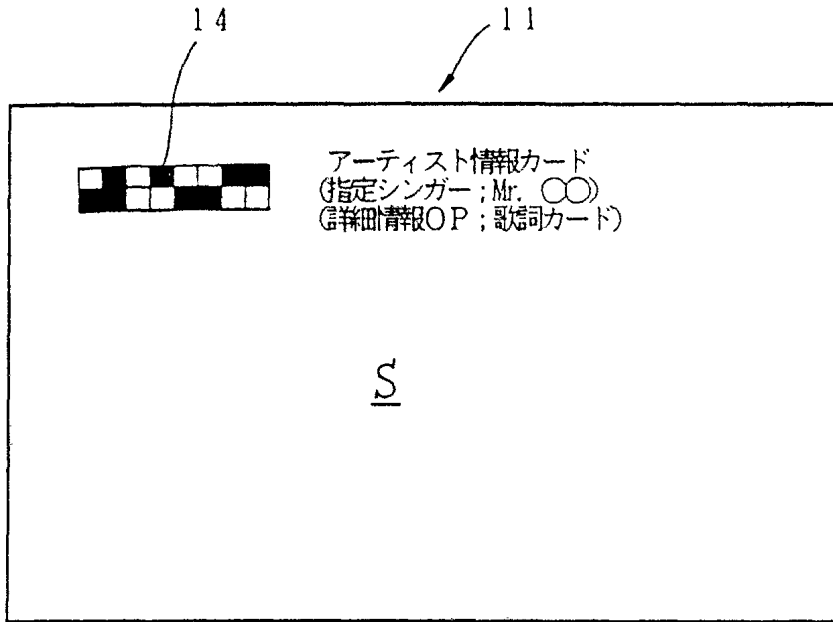

第 4 図

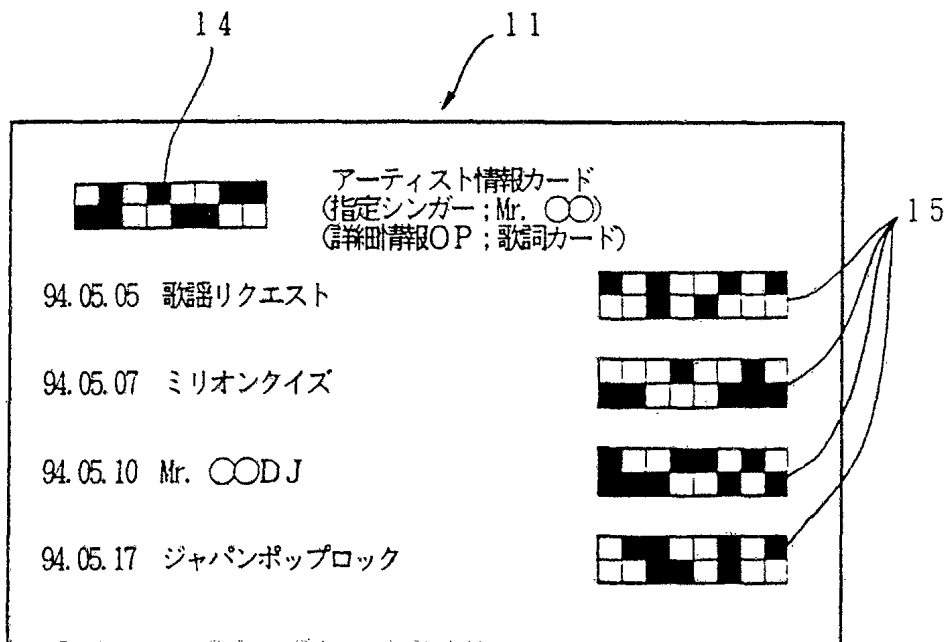

第 5 図

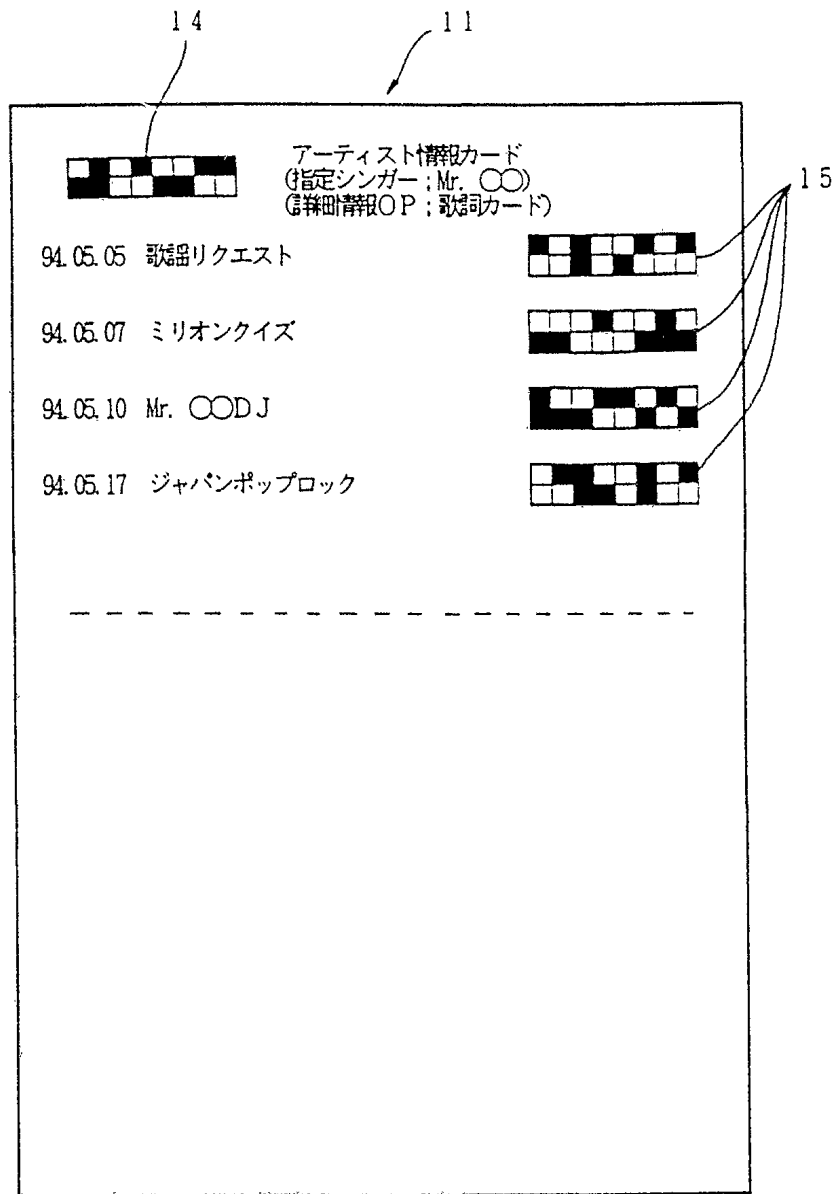

第 6 図

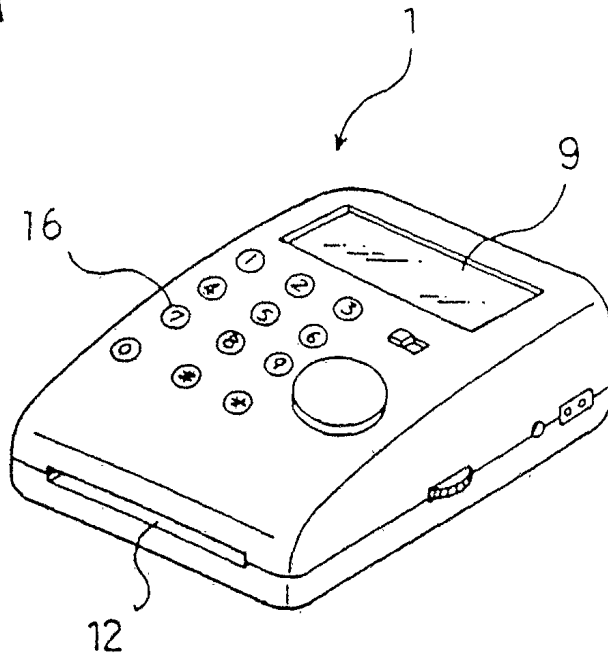

第 7 図

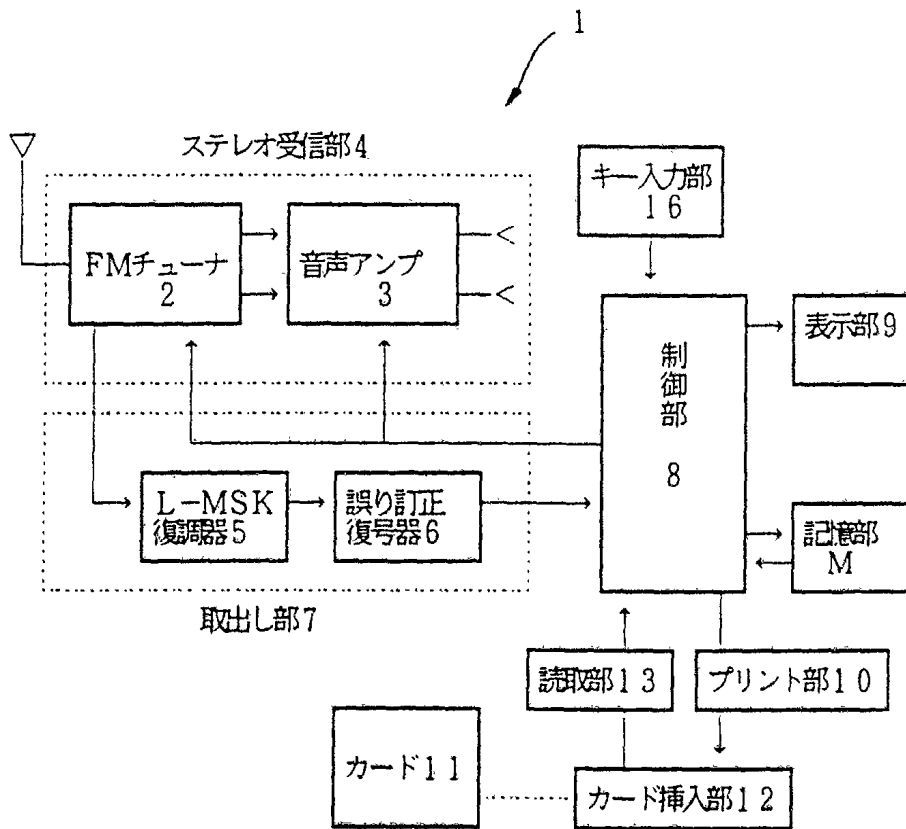

第 8 図

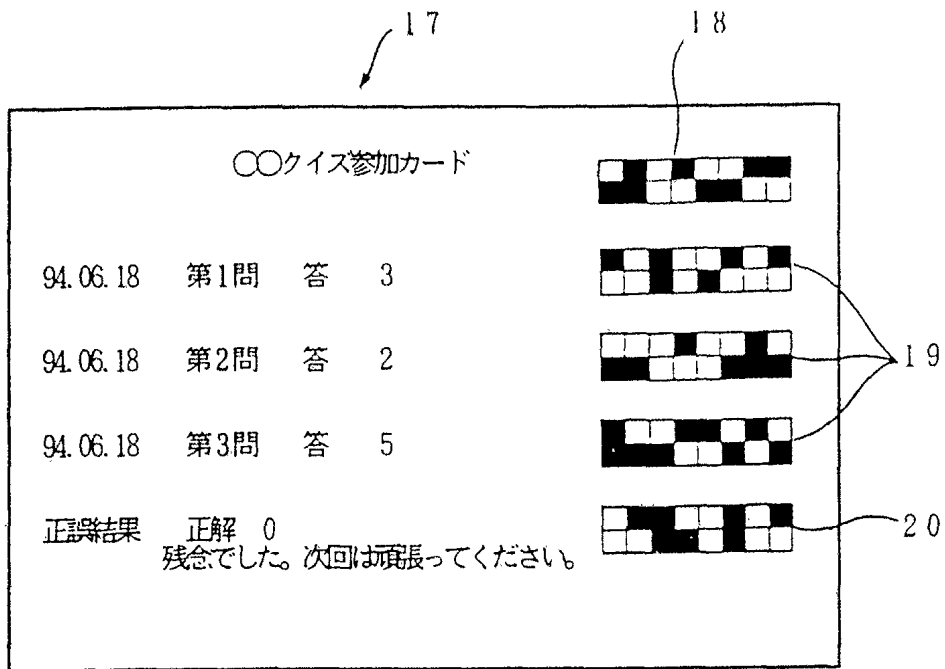

第 9 図

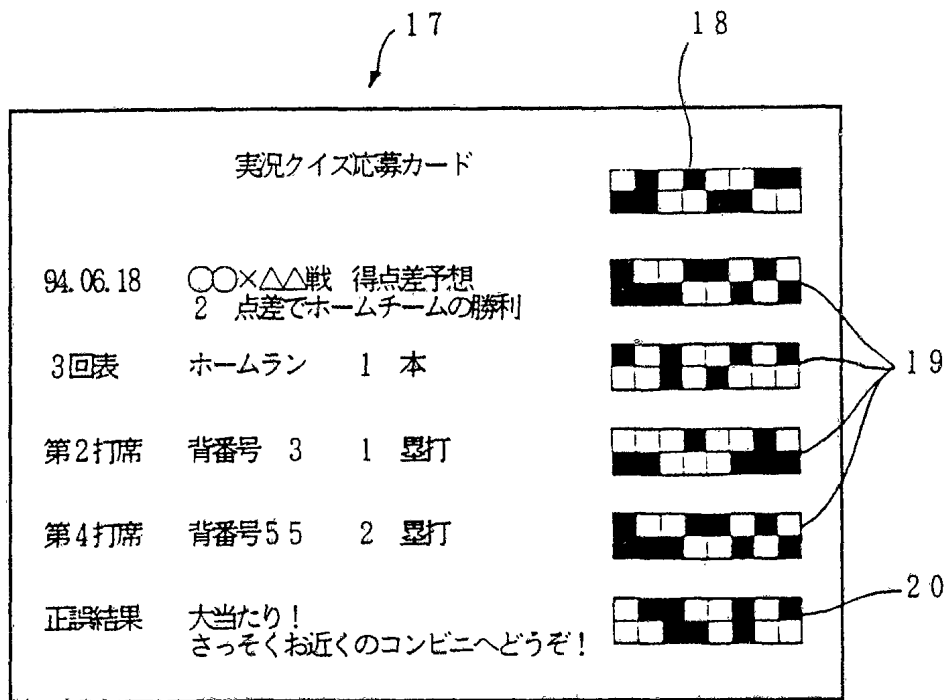

第 10 図

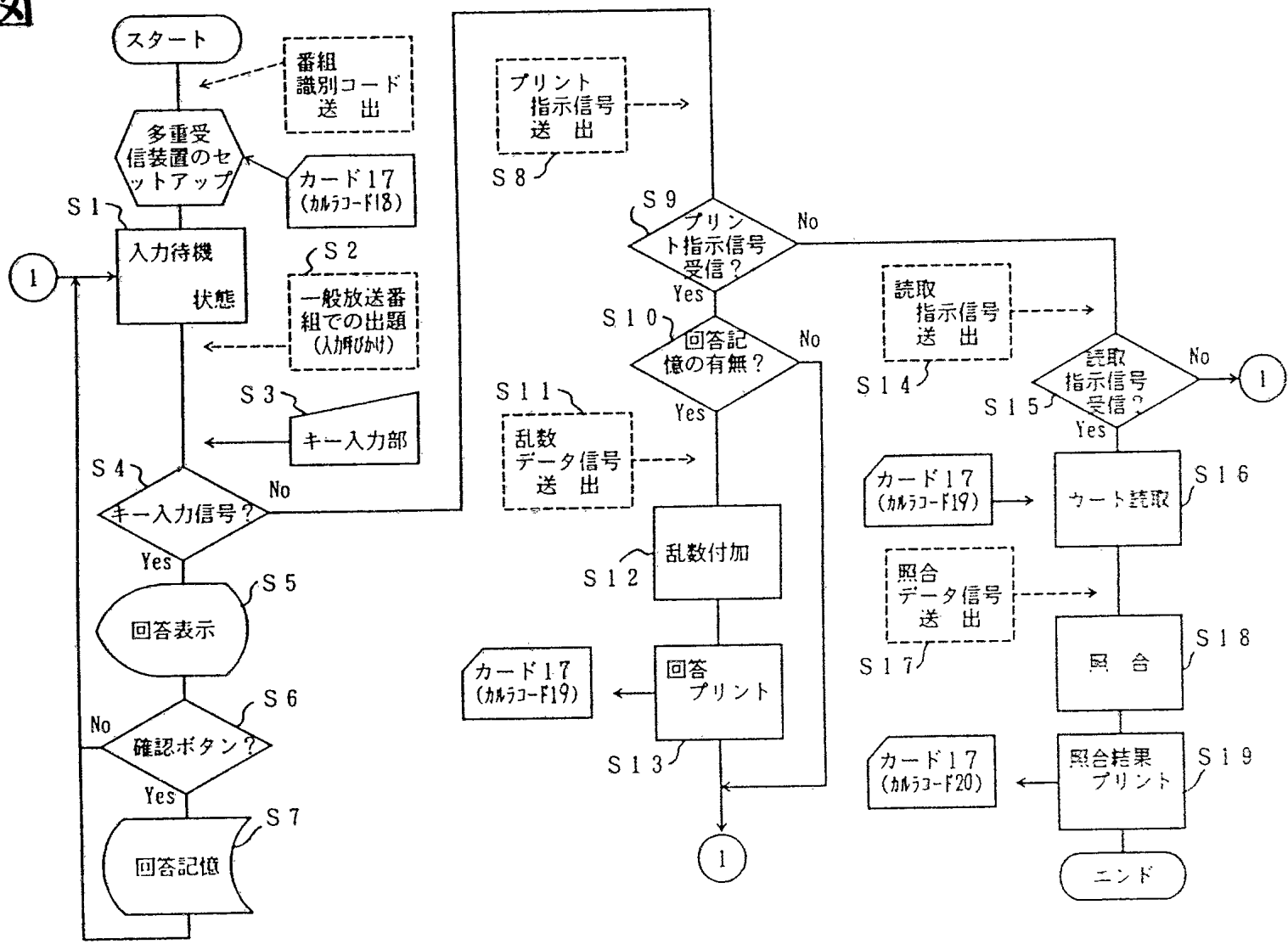

6/9

INTERNATIONAL SEARCH REPORT

International application No

PCT/JP95/01017

A. CLASSIFICATION OF SUBJECT MATTER

Int. Cl⁶ H04H1/00, H04H9/00

According to International Patent Classification (IPC) or to both national classification and IPC

B. FIELDS SEARCHED

Minimum documentation searched (classification system followed by classification symbols)

Int. Cl⁶ H04H1/00, H04H9/00

Documentation searched other than minimum documentation to the extent that such documents are included in the fields searched

Jitsuyo Shinan Koho 1926 - 1995

Kokai Jitsuyo Shinan Koho 1971 - 1995

Electronic data base consulted during the international search (name of data base and, where practicable, search terms used)

C. DOCUMENTS CONSIDERED TO BE RELEVANT

Category*	Citation of document, with indication, where appropriate, of the relevant passages	Relevant to claim No.
Y	JP, 1-115232, A (SJS-Thomson Microelectronics S.A.), May 8, 1989 (08. 05. 89), Line 3, upper right column to line 9, lower right column, page 3, line 14, lower right column, page 5 to line 20, upper left column, page 6 & EP, 309326, A1	1-7, 8
Y	JP, 5-83216, A (Nippon Hoso Kyokai), April 2, 1993 (02. 04. 93) Columns (0017) to (0020) (Family: none)	1-7, 8
Y	JP, 4-14918, A (Mitsubishi Electric Corp.), January 20, 1992 (20. 01. 92), Claim (Family: none)	1-7, 8

 Further documents are listed in the continuation of Box C. See patent family annex.

* Special categories of cited documents:

"A" document defining the general state of the art which is not considered to be of particular relevance

"E" earlier document but published on or after the international filing date

"L" document which may throw doubts on priority claim(s) or which is cited to establish the publication date of another citation or other special reason (as specified)

"O" document referring to an oral disclosure, use, exhibition or other means

"P" document published prior to the international filing date but later than the priority date claimed

"T" later document published after the international filing date or priority date and not in conflict with the application but cited to understand the principle or theory underlying the invention

"X" document of particular relevance; the claimed invention cannot be considered novel or cannot be considered to involve an inventive step when the document is taken alone

"Y" document of particular relevance; the claimed invention cannot be considered to involve an inventive step when the document is combined with one or more other such documents, such combination being obvious to a person skilled in the art

"&" document member of the same patent family

Date of the actual completion of the international search
August 4, 1995 (04. 08. 95)Date of mailing of the international search report
August 29, 1995 (29. 08. 95)Name and mailing address of the ISA/
Japanese Patent Office

Authorized officer

Facsimile No.

Telephone No.

A 発明の属する分野の分類 (国際特許分類 (IPC))

Int. Cl.⁸ H04H1/00, H04H9/00

B 調査を行つた分野

調査を行つた最小限資料 (国際特許分類 (IPC))

Int. Cl.⁸ H04H1/00, H04H9/00

最小限資料以外の資料で調査を行つた分野に含まれるもの

日本国実用新案公報 1926-1995年
日本国公開実用新案公報 1971-1995年

国際調査で使用した電子データベース (データベース) (の名称、調査に使用した用語)

C 関連すると認められる文献

引用文献の カテゴリ *	引用文献名 及び 一部の箇所が関連するときは その関連する箇所の表示	関連する 請求の範囲の番号
Y	JP, 1-115232, A (エスジエー エーストムソン マイクロエレクトロニクス エス. アー.), 8. 5月, 1989 (08. 05. 89), 第3頁右上欄第3行-同右F欄第9行, 第5頁右下欄 第14行-第6頁左上欄第20行 & EP, 309326, A1	1-7, 8
Y	JP, 5-83216, A (日本放送協会). 2. 4月, 1993 (02. 04. 93) [0017]-[0020] 欄 (ファミリーなし)	1-7, 8

C欄の続きにも文献が列挙されている。 パラグラフ (に関する別紙を参照)

* 引用文献のカテゴリ

- 「A」 特に関連のある文献ではなく、一般的技術水準を示すもの
- 「E」 先行文献ではあるが、国際出願日以後に公表されたもの
- 「L」 優先権主張に疑義を提起する文献又は他の文献の発行日若しくは他の特別な理由を確立するために引用する文献 (理由を付す)
- 「O」 口頭による開示、使用、展示等に言及する文献
- 「P」 国際出願日前で、かつ優先権の主張の基礎となる出願の日の後に公表された文献

- 「T」 国際出願日又は優先日後に公表された文献であって出願と矛盾するものではなく、発明の原理又は理論の理解のために引用するもの
- 「X」 特に関連のある文献であって、当該文献のみで発明の新規性又は進歩性がないと考えられるもの
- 「Y」 特に関連のある文献であって、当該文献と他の1以上の文献との、当業者にとって自明である組合せによって進歩性がないと考えられるもの
- 「&」 同一パテントファミリー文献

国際調査を完了した日
04. 08. 95

国際調査報告の発送日
29.08.95

名称及びあて先
日本国特許庁 (ISA/JP)
郵便番号100
東京都千代田区霞が関三丁目4番3号

特許庁審査官 (権限のある職員)

吉見信明

5 K 2 1 1 6

電話番号 03-3581-1101 内線 3557

C (続き)、 関連すると認められる文献

引用文献の カテゴリー*	引用文献名 及び一部の箇所が関連するときは、その関連する箇所の表示	関連する 請求の範囲の番号
Y	JP, 4-14918, A (三菱電機株式会社), 20, 1月, 1992 (20, 01, 92), 特許請求の範囲 (ファミリーなし)	1-7, 8