



US00D832425S

(12) **United States Design Patent** (10) **Patent No.:** **US D832,425 S**
Adams, III (45) **Date of Patent:** **** Oct. 30, 2018**

(54) **URINAL**

D578,211 S * 10/2008 Maze D24/122
D685,465 S * 7/2013 Reda D24/122
2017/0312157 A1* 11/2017 Solazzo A61G 9/006

* cited by examiner

(71) Applicant: **GMAX Industries, Inc.**, Hauppauge, NY (US)

(72) Inventor: **Adam Edward Adams, III**, Naperville, IL (US)

Primary Examiner — David G Muller
(74) *Attorney, Agent, or Firm* — Vinson & Elkins LLP

(73) Assignee: **GMAX Industries, Inc.**, Hauppauge, NY (US)

(57) **CLAIM**

I claim the ornamental design for a urinal, as shown and described.

(**) Term: **15 Years**

DESCRIPTION

(21) Appl. No.: **29/584,669**

FIG. 1 is a rear view of my urinal design with the lid attached in an assembled state.

(22) Filed: **Nov. 16, 2016**

FIG. 2 is a bottom perspective view of my urinal design with the lid attached in an assembled state.

(51) **LOC (11) Cl.** **24-04**

FIG. 3 is a rear view of my urinal design with the lid detached.

(52) **U.S. Cl.**

USPC **D24/122**

(58) **Field of Classification Search**

USPC D24/121–123, 117, 224; D23/276, 295, D23/302, 274, 309, 200; 4/450–460, 4/144.1–144.4, DIG. 5; 600/573, 574; 604/329, 317, 318, 334

CPC A61G 9/00; A61G 9/006; A61G 9/003

See application file for complete search history.

FIG. 4 is a top view of my urinal design.

FIG. 5 is a left side view my urinal design.

FIG. 6 is a rear view my urinal design.

FIG. 7 is a right side view my urinal design.

FIG. 8 is a rear view my urinal design.

FIG. 9 is top front perspective view of my urinal design.

FIG. 10 is a top rear perspective view of my urinal design.

FIG. 11 is a bottom view of my urinal design.

FIG. 12 is an alternative perspective view of my urinal design.

FIG. 13 is a top view of the lid of my urinal design.

FIG. 14 is a side view of the lid of my urinal design.

FIG. 15 is a bottom view of the lid of my urinal design.

FIG. 16 is a bottom perspective view of the lid of my urinal design; and,

FIG. 17 is an alternative bottom perspective view of the lid of my urinal design.

Broken lines in the figures indicate boundaries that form no part of the claimed design.

(56) **References Cited**

U.S. PATENT DOCUMENTS

D297,462 S * 8/1988 Meunchen D24/122
D304,373 S * 10/1989 Floyd D24/122
D348,315 S * 6/1994 Hanifl D24/117
D360,943 S * 8/1995 Lafond D24/122
D371,842 S * 7/1996 Pilsworth D24/122
D389,240 S * 1/1998 Corona D24/121
D390,657 S * 2/1998 Asta D23/302
D399,308 S * 10/1998 Garlock D24/122
6,021,530 A * 2/2000 Davis A61G 9/006
4/144.1
D439,970 S * 4/2001 Fisher D24/121

1 Claim, 17 Drawing Sheets

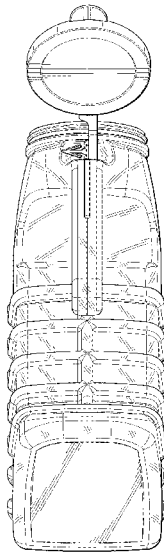

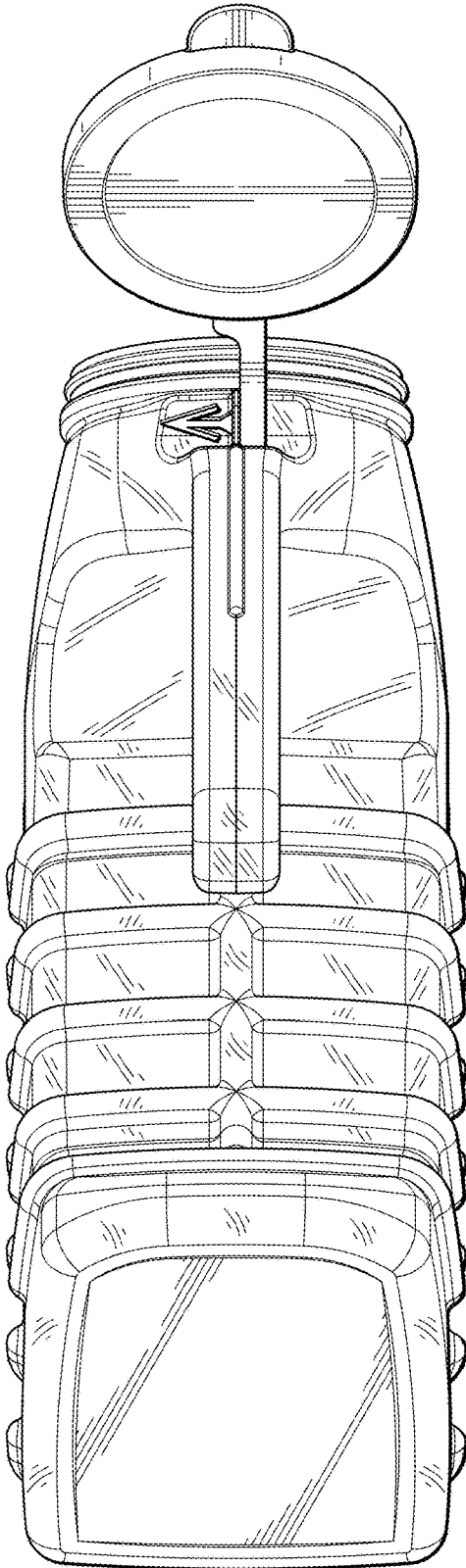

FIG. 1

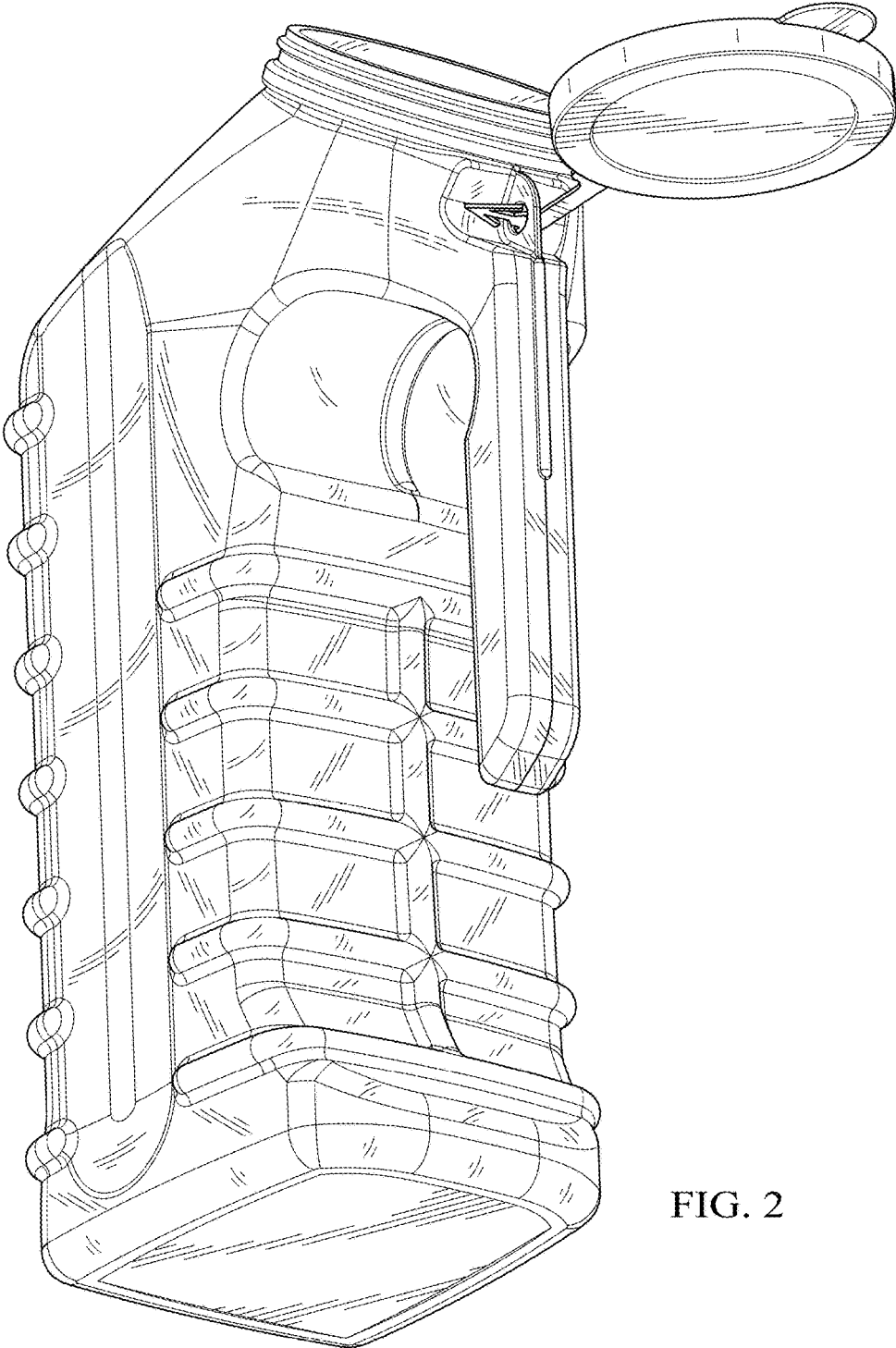

FIG. 2

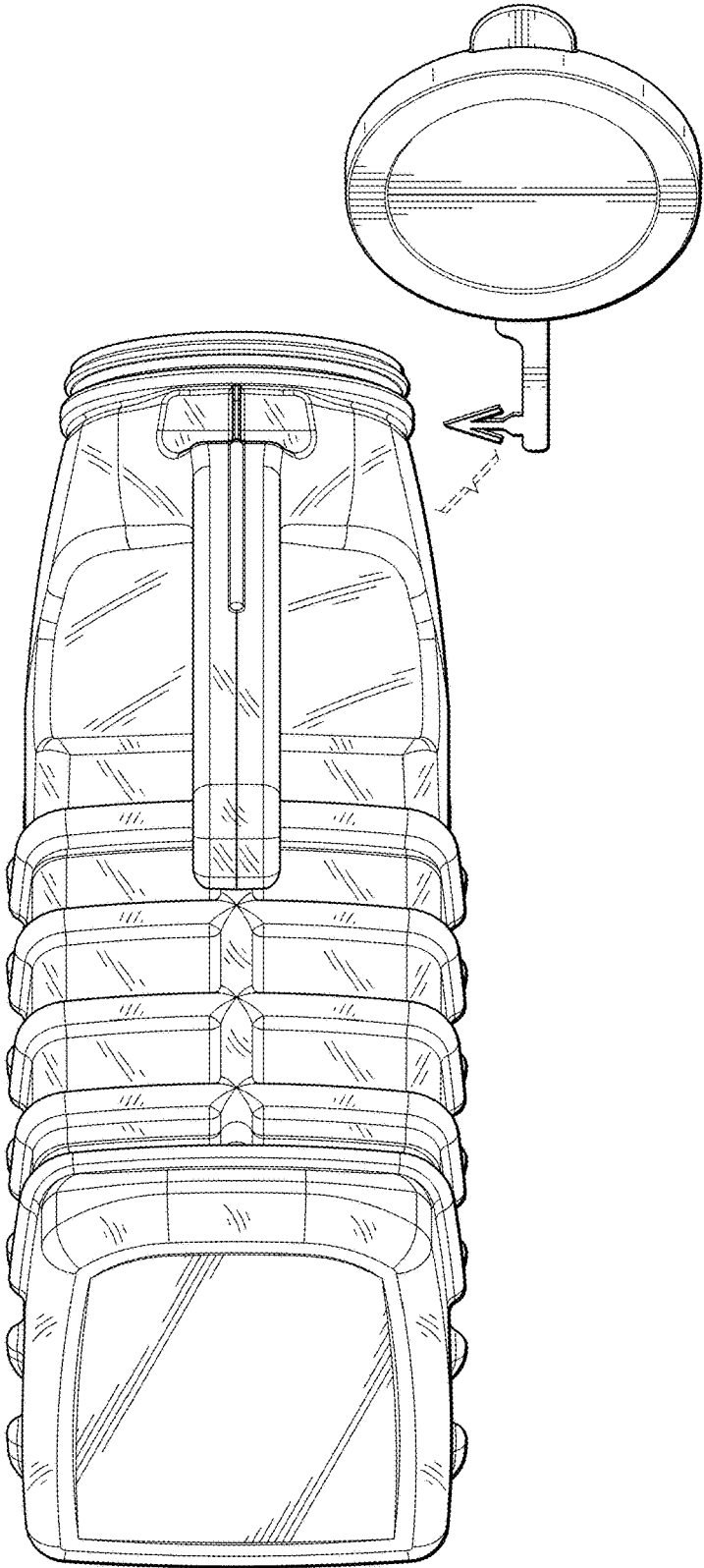

FIG. 3

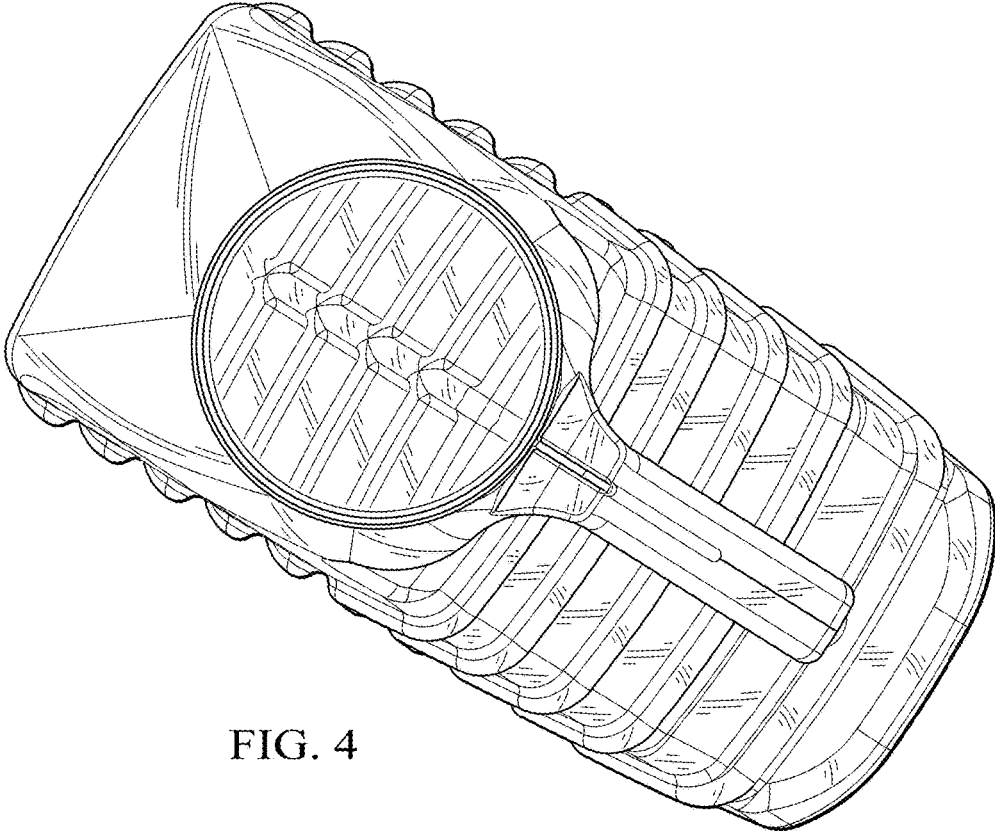

FIG. 4

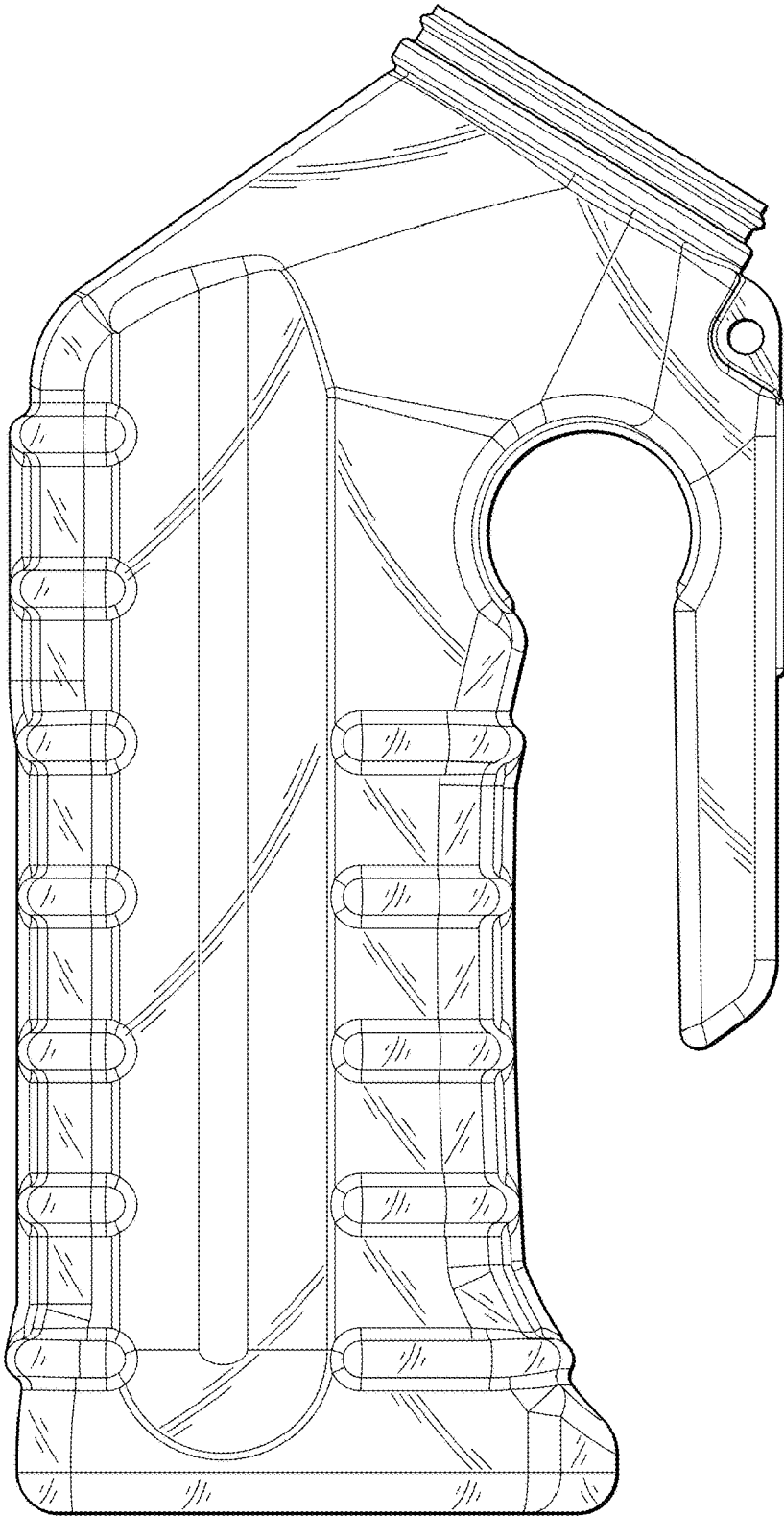

FIG. 5

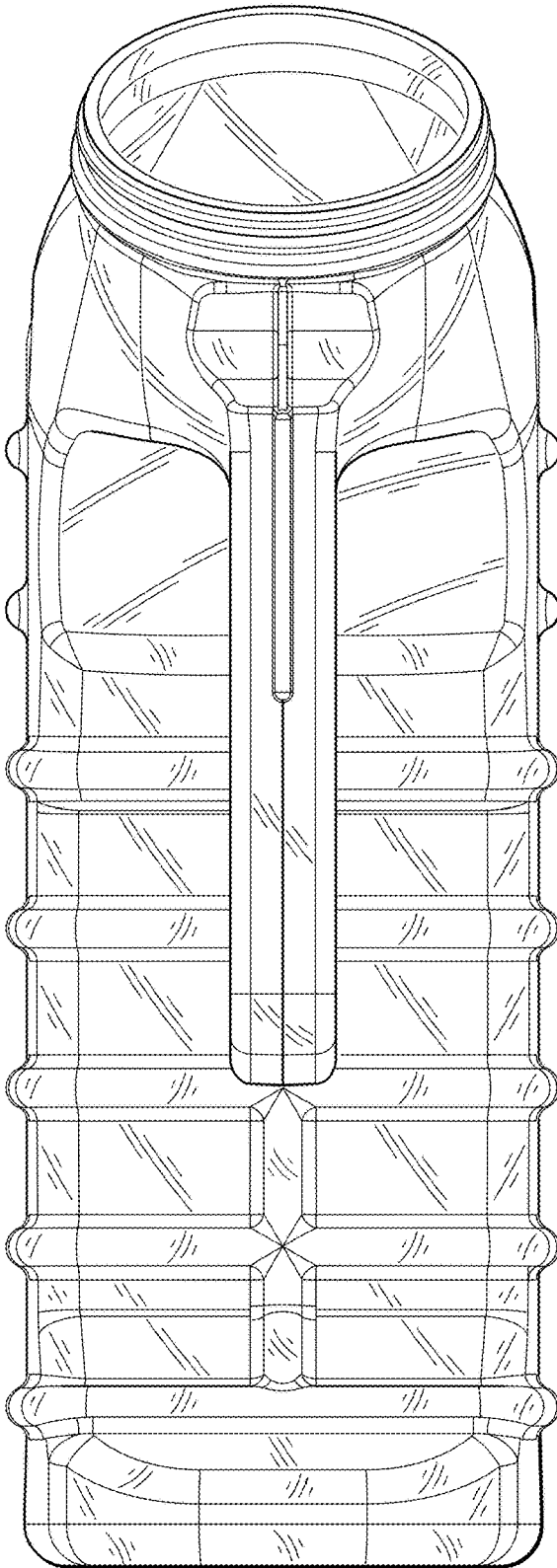

FIG. 6

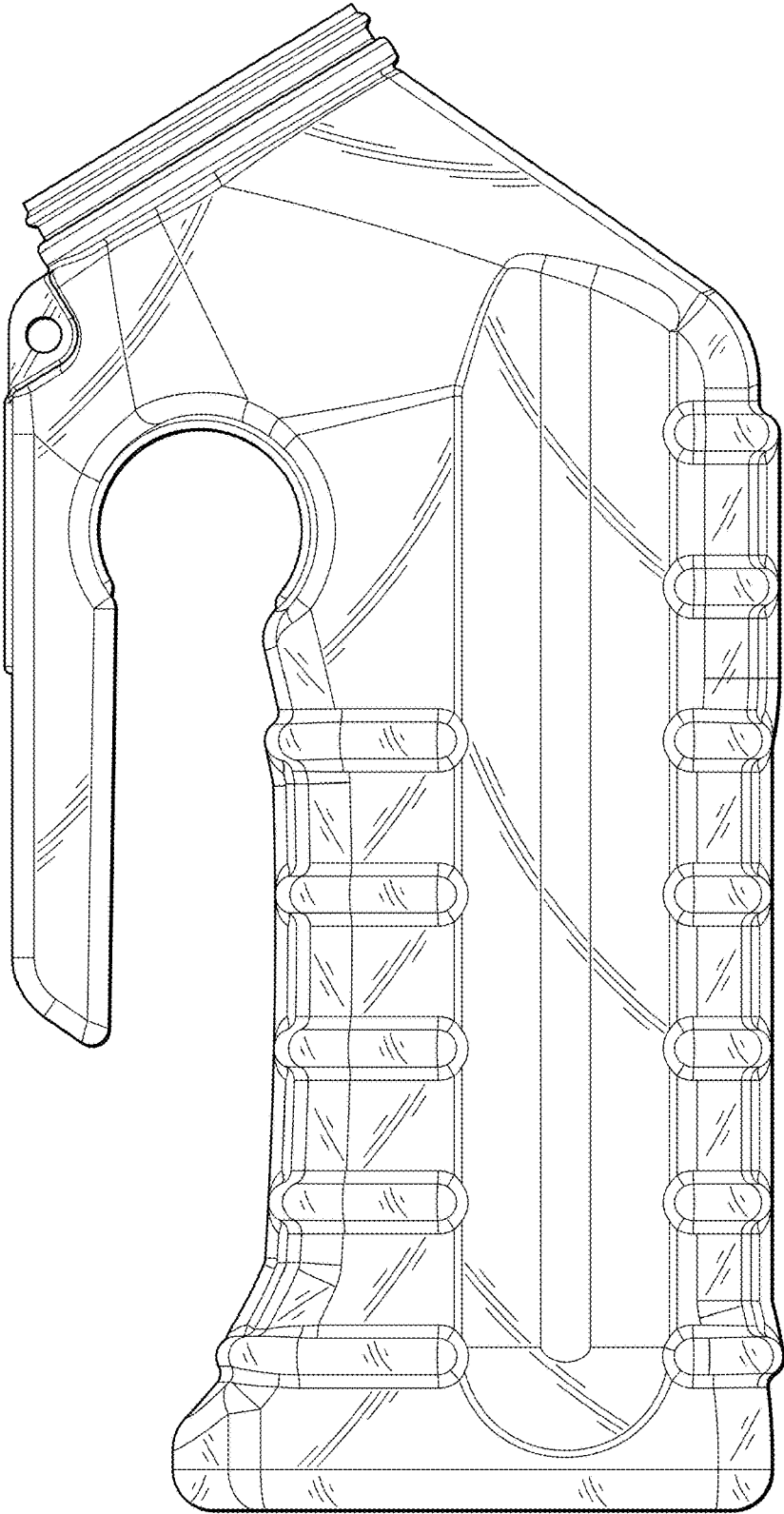

FIG. 7

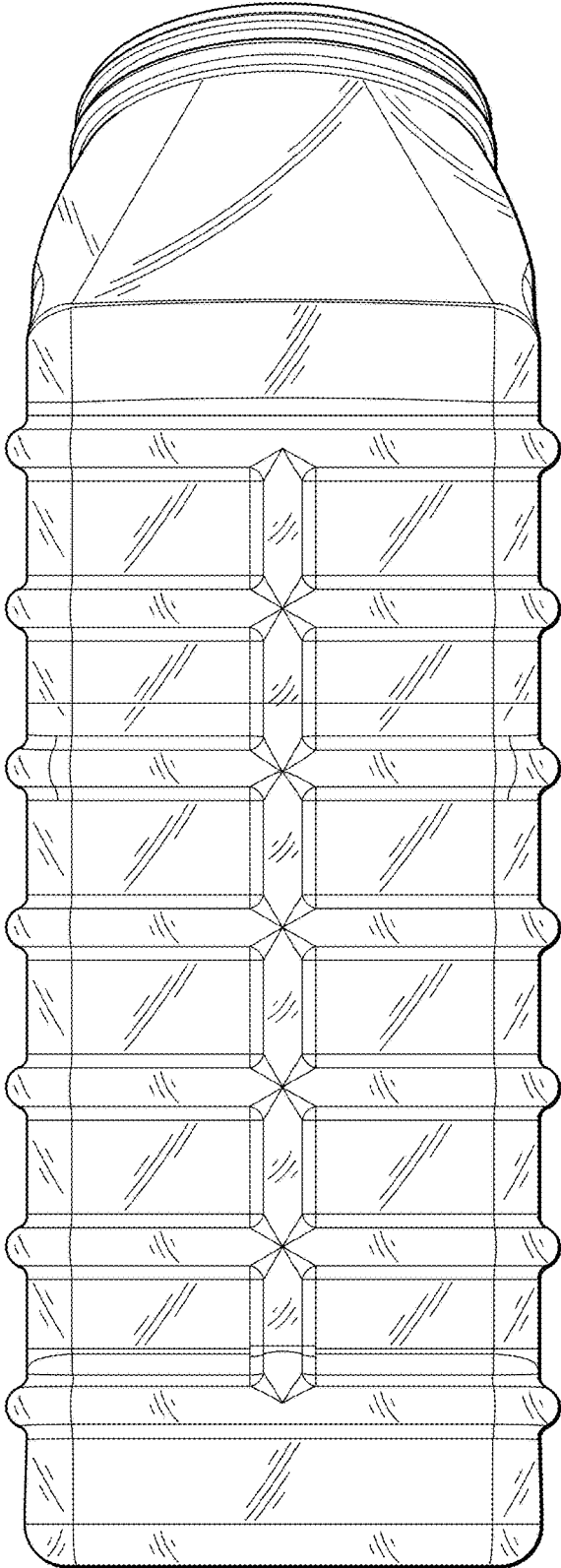

FIG. 8

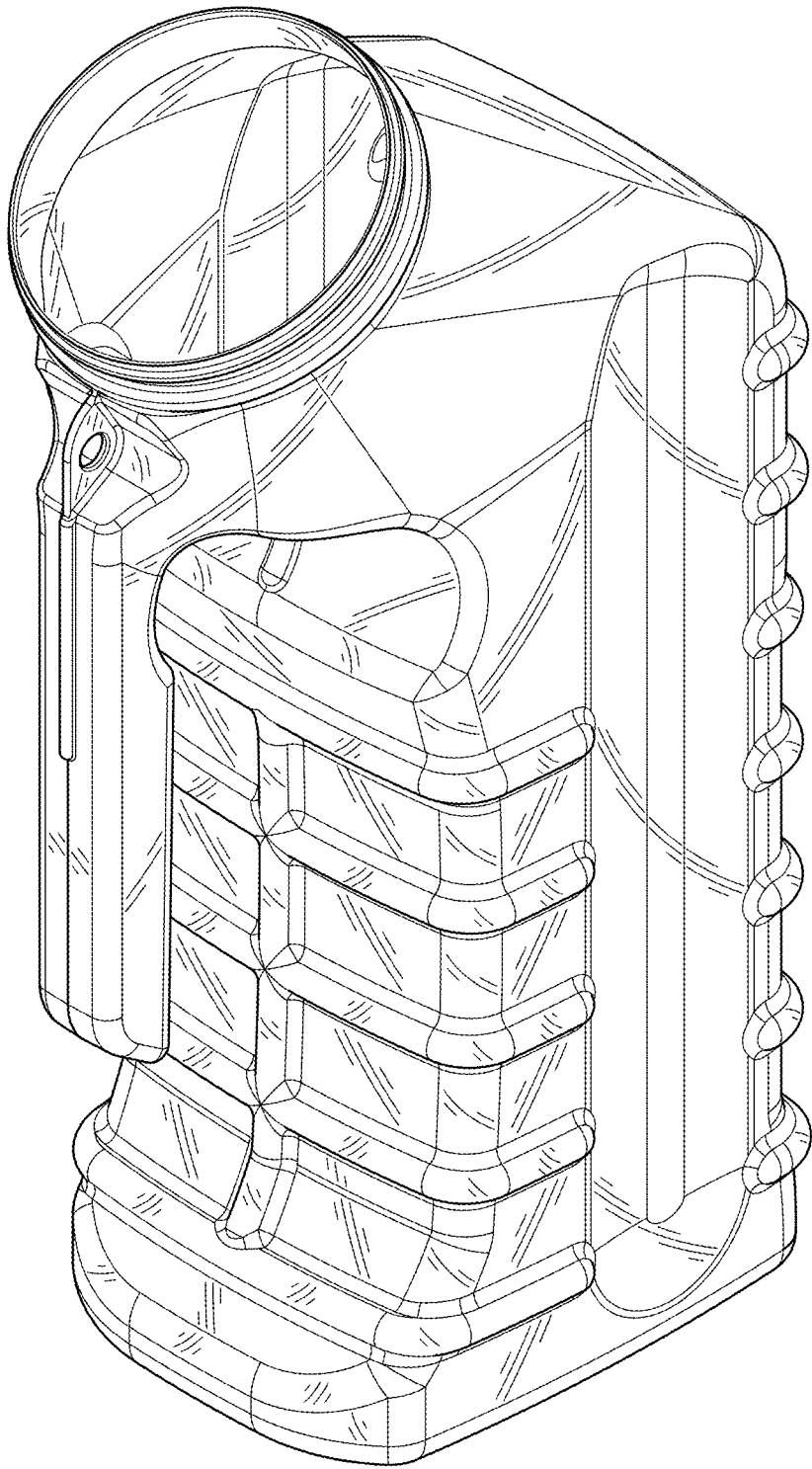

FIG. 9

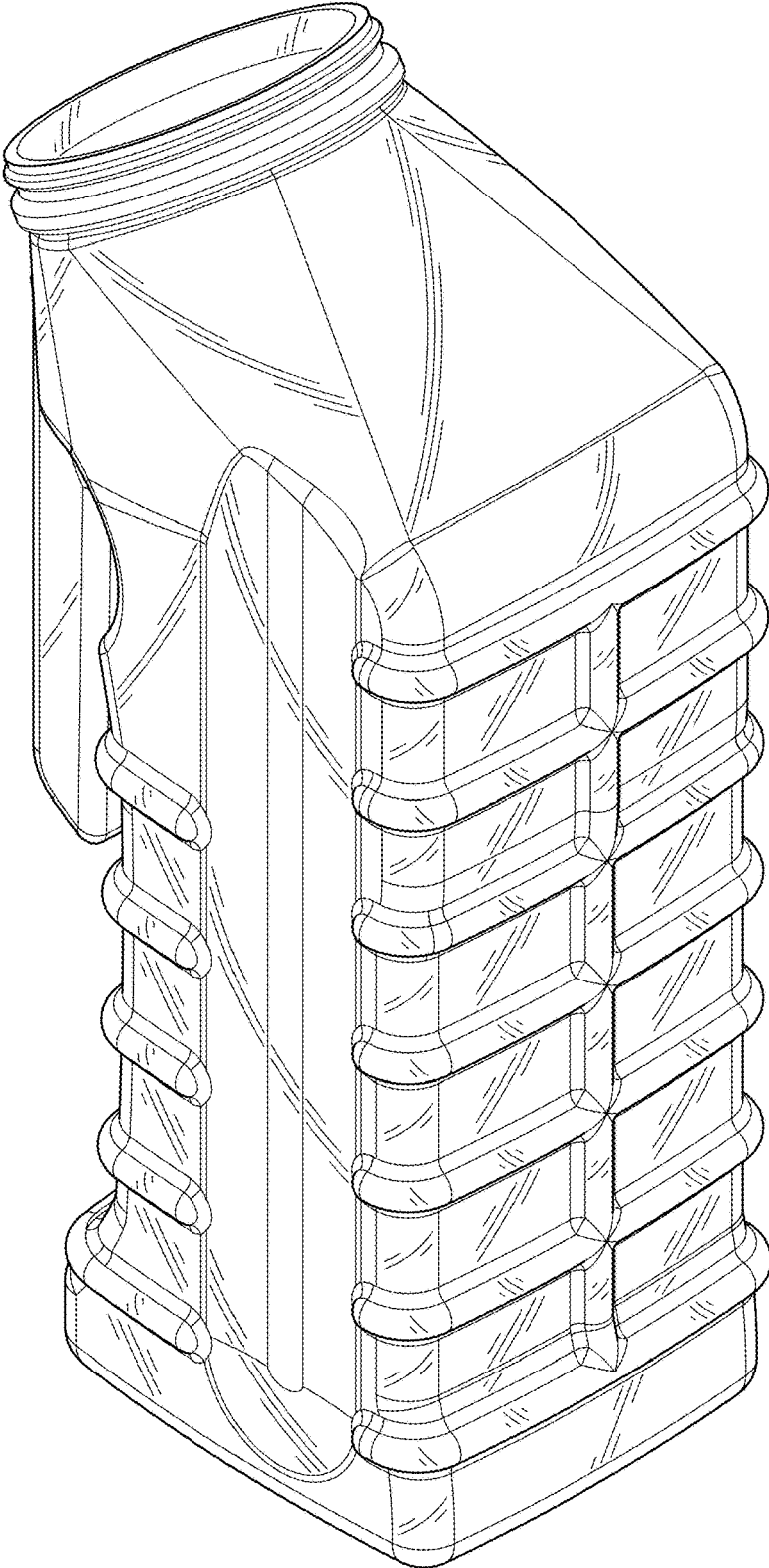

FIG. 10

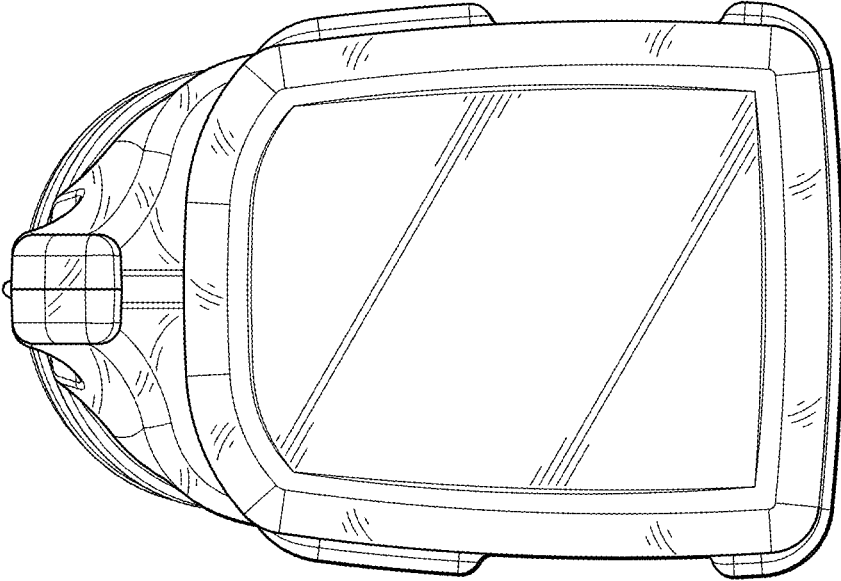

FIG. 11

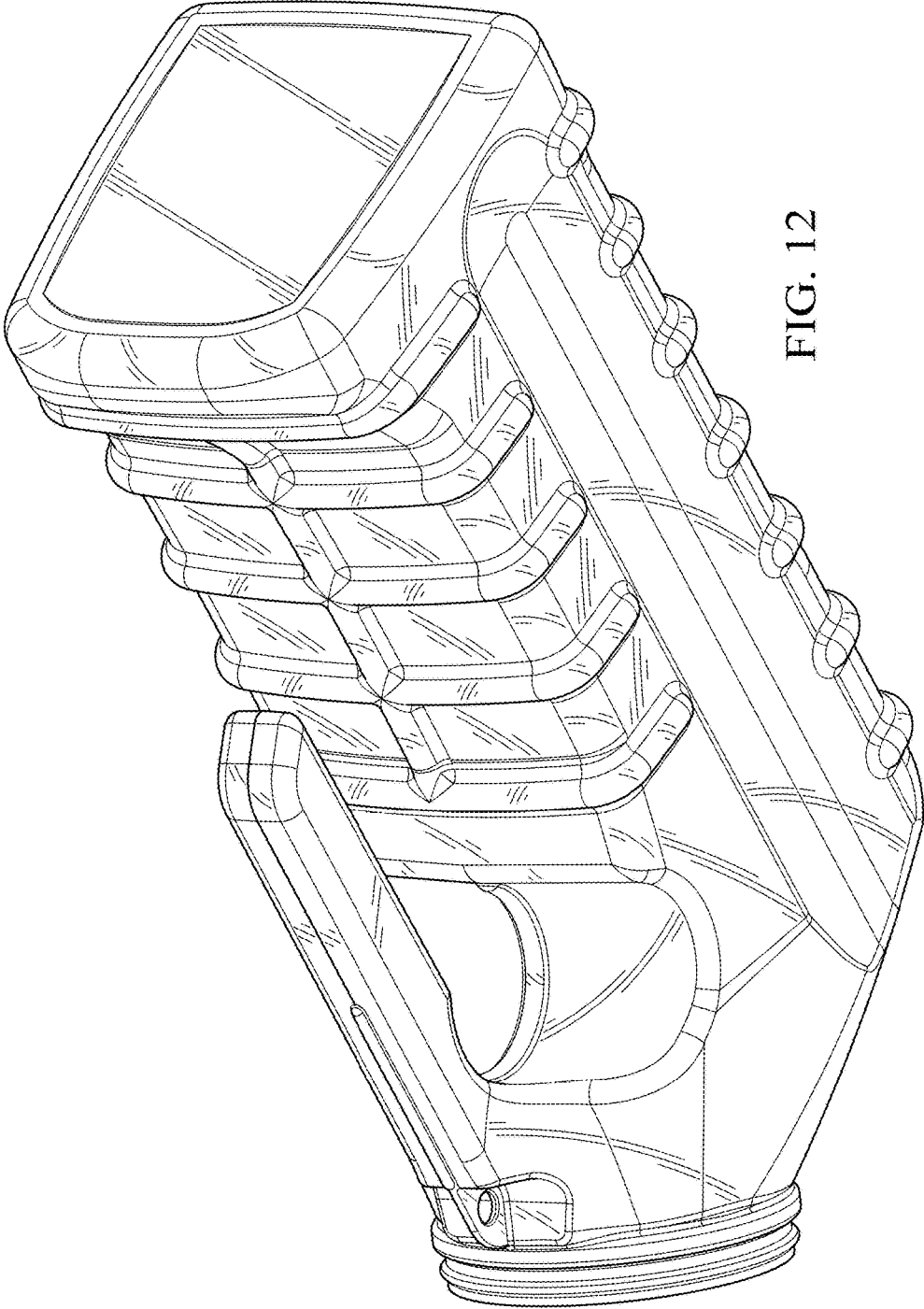

FIG. 12

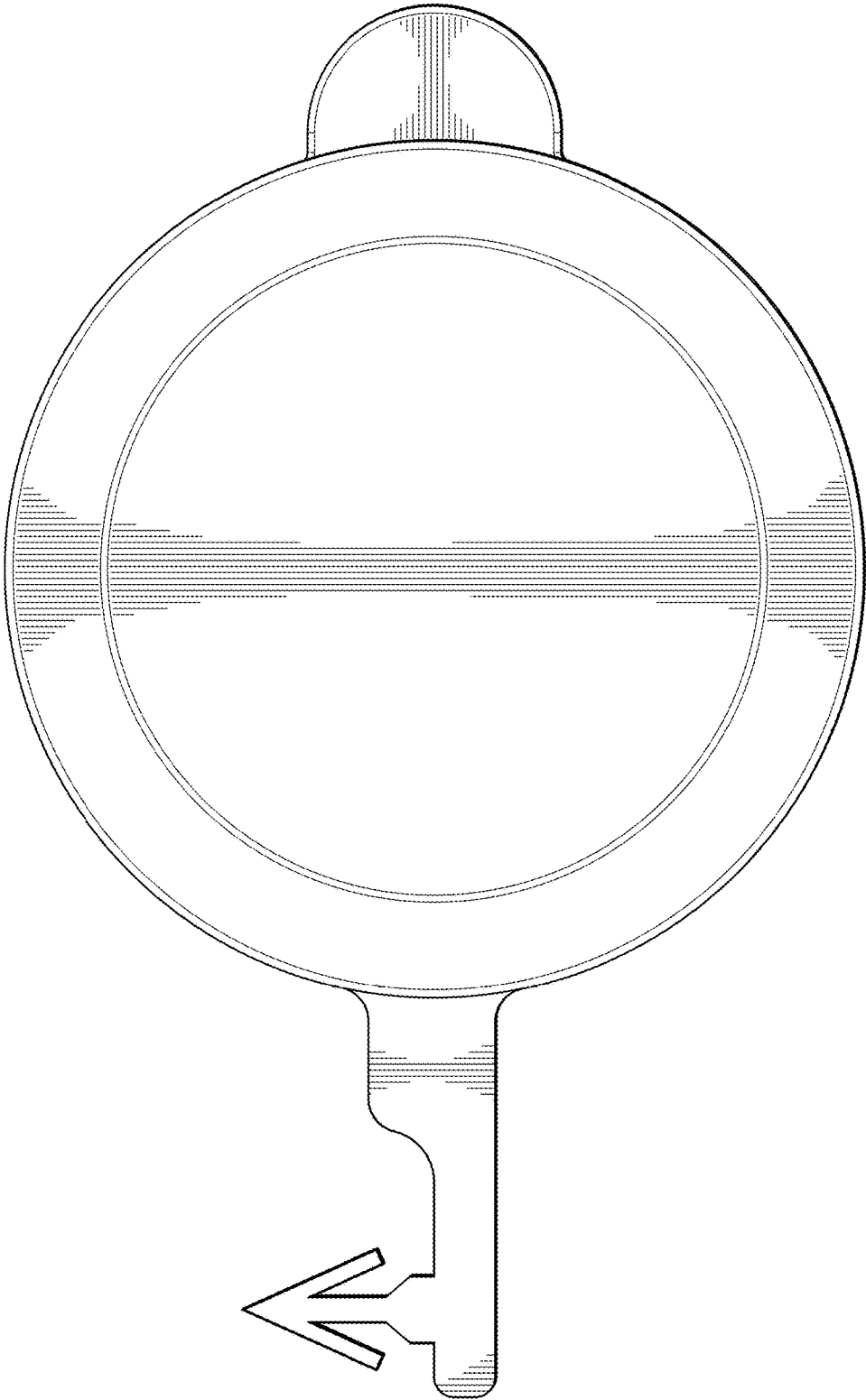

FIG. 13

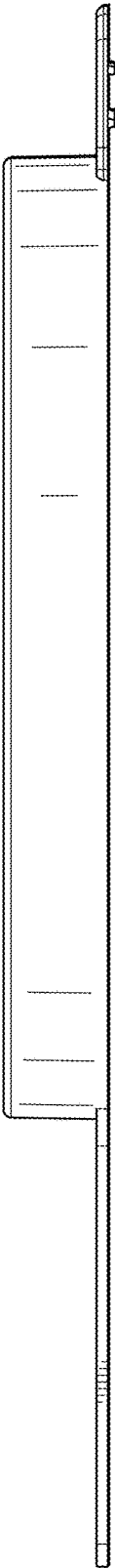

FIG. 14

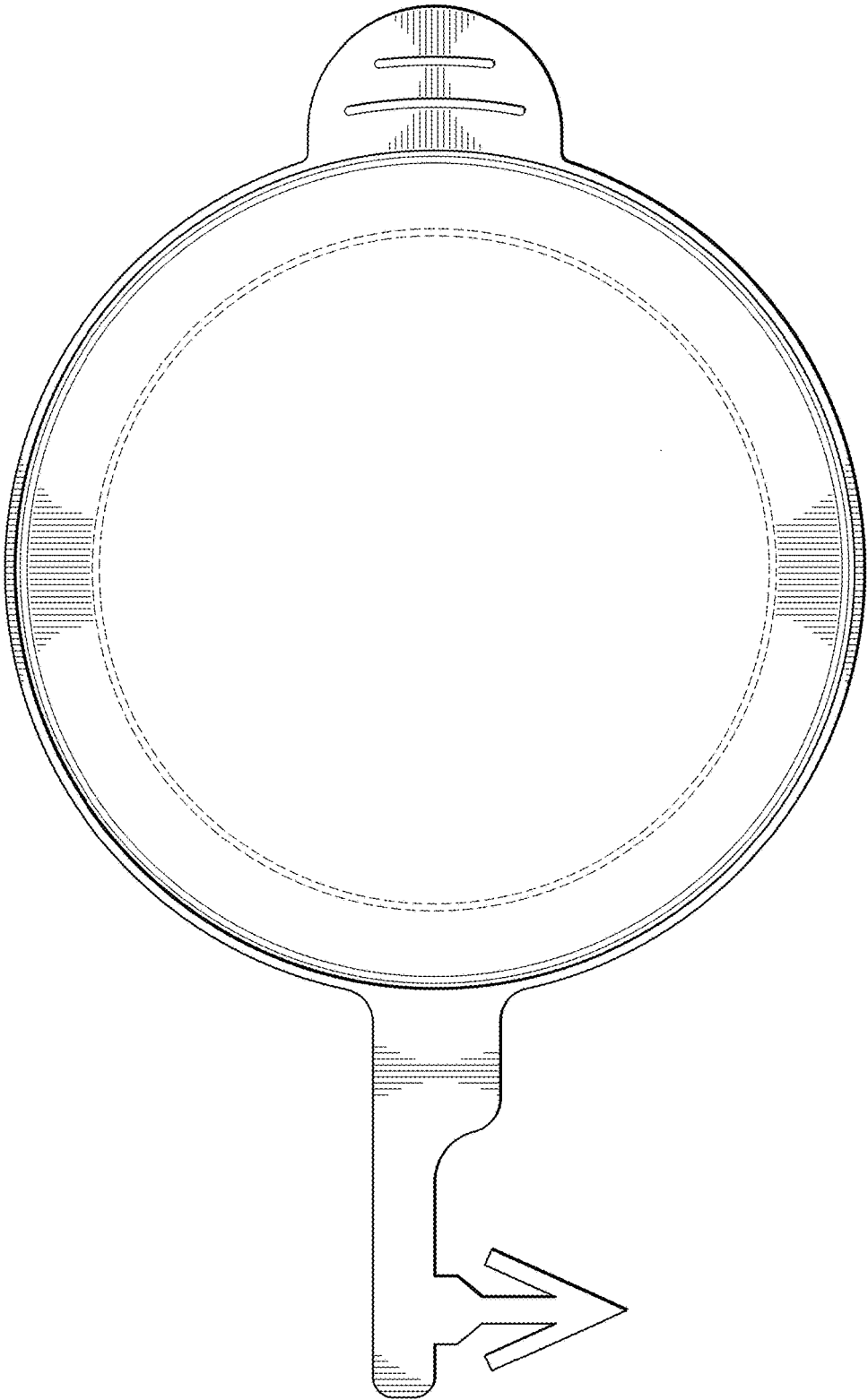

FIG. 15

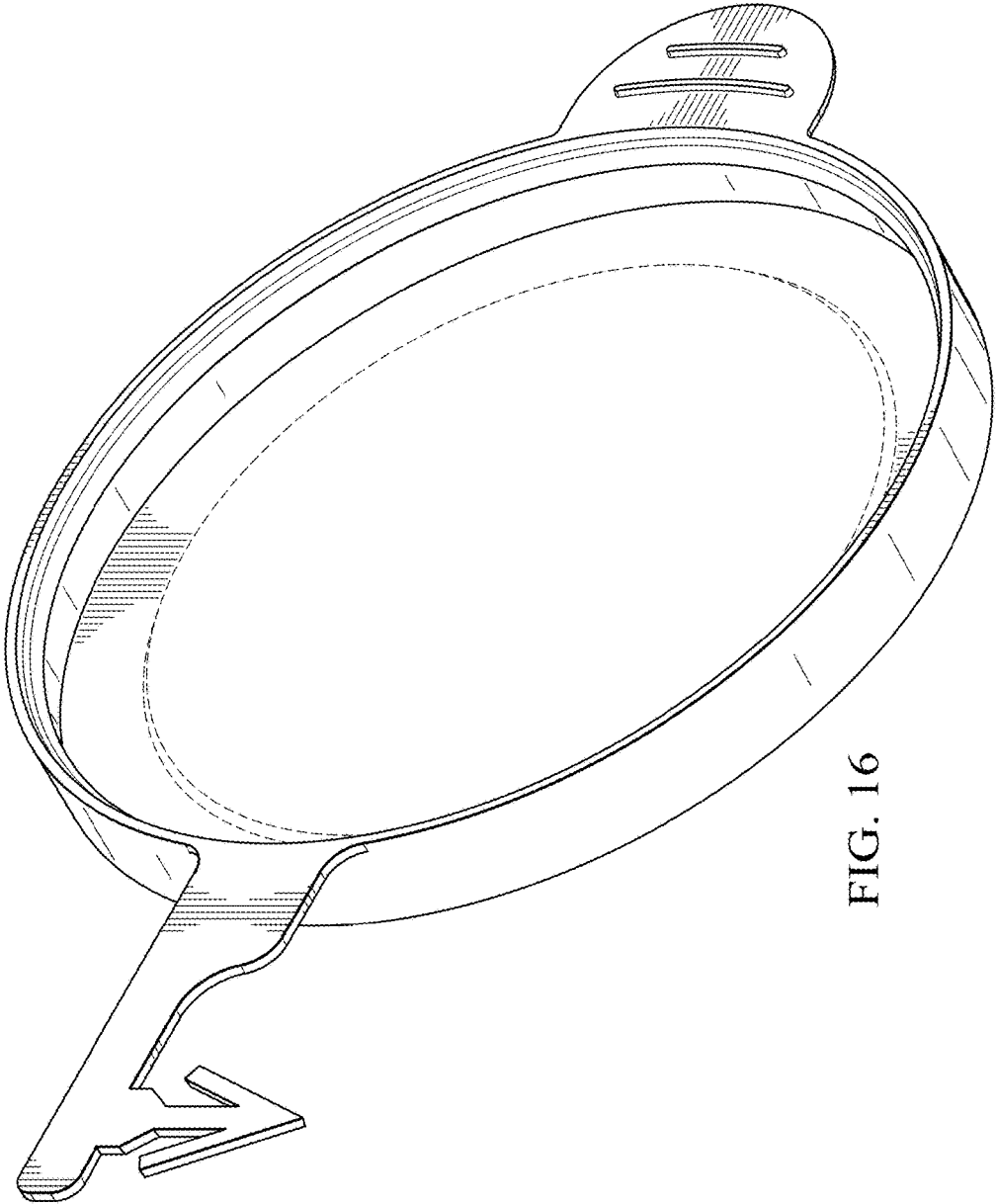

FIG. 16

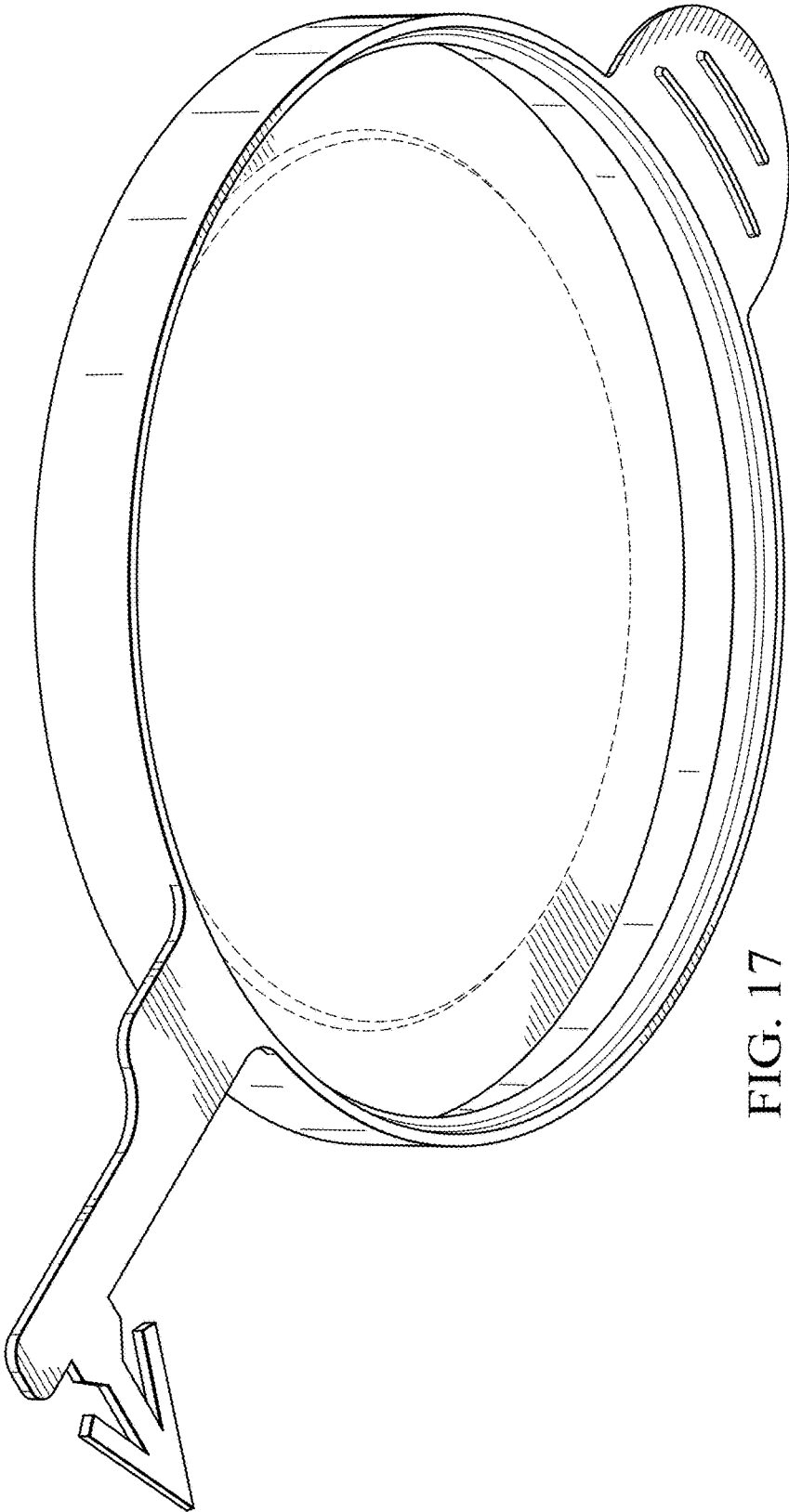

FIG. 17