

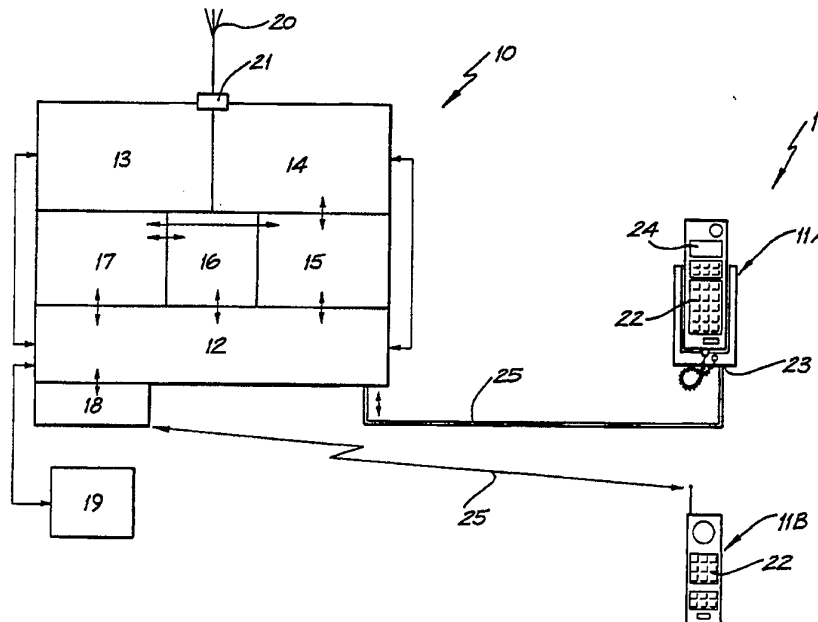

INTERNATIONAL APPLICATION PUBLISHED UNDER THE PATENT COOPERATION TREATY (PCT)

<p>(51) International Patent Classification <sup>6</sup> : <b>H04Q 7/20</b></p>	<p><b>A1</b></p>	<p>(11) International Publication Number: <b>WO 95/23485</b> (43) International Publication Date: 31 August 1995 (31.08.95)</p>
<p>(21) International Application Number: PCT/AU95/00098 (22) International Filing Date: 28 February 1995 (28.02.95) (30) Priority Data: PM 4143 28 February 1994 (28.02.94) AU (71) Applicant (for all designated States except US): VOXSON INTERNATIONAL PTY. LIMITED [AU/AU]; 231 Holt Street, Pinkenba, QLD 4008 (AU). (72) Inventor; and (75) Inventor/Applicant (for US only): LONGGINOU, Lucas [AU/AU]; 55 Riverview Terrace, Hamilton, QLD 4007 (AU). (74) Agent: MAXWELL, Peter, Francis; Peter Maxwell &amp; Associates, Blaxland House, 5 Ross Street, North Parramatta, NSW 2151 (AU).</p>		<p>(81) Designated States: AM, AT, AU, BB, BG, BR, BY, CA, CH, CN, CZ, DE, DK, EE, ES, FI, GB, GE, HU, JP, KE, KG, KP, KR, KZ, LK, LR, LT, LU, LV, MD, MG, MN, MW, MX, NL, NO, NZ, PL, PT, RO, RU, SD, SE, SG, SI, SK, TJ, TT, UA, UG, US, UZ, VN, European patent (AT, BE, CH, DE, DK, ES, FR, GB, GR, IE, IT, LU, MC, NL, PT, SE), OAPI patent (BF, BJ, CF, CG, CI, CM, GA, GN, ML, MR, NE, SN, TD, TG), ARIPO patent (KE, MW, SD, SZ, UG).  <b>Published</b> <i>With international search report.</i></p>

(54) Title: MULTI-MODE COMMUNICATIONS SYSTEM



(57) Abstract

A multi-mode communication system including a hand-held phone module (11) and incorporating a base unit (10) allowing selection of multiple operational modes. The system allows a user to select from at least two different network communication protocols and standards (i.e. cellular, trunking, cordless, DGPS, etc.). The hand held phone module and the base unit can be a single handset. Mode selection can be either automatic or manual.

**FOR THE PURPOSES OF INFORMATION ONLY**

Codes used to identify States party to the PCT on the front pages of pamphlets publishing international applications under the PCT.

AT	Austria	GB	United Kingdom	MR	Mauritania
AU	Australia	GE	Georgia	MW	Malawi
BB	Barbados	GN	Guinea	NE	Niger
BE	Belgium	GR	Greece	NL	Netherlands
BF	Burkina Faso	HU	Hungary	NO	Norway
BG	Bulgaria	IE	Ireland	NZ	New Zealand
BJ	Benin	IT	Italy	PL	Poland
BR	Brazil	JP	Japan	PT	Portugal
BY	Belarus	KE	Kenya	RO	Romania
CA	Canada	KG	Kyrgystan	RU	Russian Federation
CF	Central African Republic	KP	Democratic People's Republic of Korea	SD	Sudan
CG	Congo	KR	Republic of Korea	SE	Sweden
CH	Switzerland	KZ	Kazakhstan	SI	Slovenia
CI	Côte d'Ivoire	LI	Liechtenstein	SK	Slovakia
CM	Cameroon	LK	Sri Lanka	SN	Senegal
CN	China	LU	Luxembourg	TD	Chad
CS	Czechoslovakia	LV	Latvia	TG	Togo
CZ	Czech Republic	MC	Monaco	TJ	Tajikistan
DE	Germany	MD	Republic of Moldova	TT	Trinidad and Tobago
DK	Denmark	MG	Madagascar	UA	Ukraine
ES	Spain	ML	Mali	US	United States of America
FI	Finland	MN	Mongolia	UZ	Uzbekistan
FR	France			VN	Viet Nam
GA	Gabon				

MULTI-MODE COMMUNICATIONS SYSTEMFIELD OF THE INVENTION

The present invention relates to multi-mode communications systems and, more particularly, to such systems incorporating a hand held means of control.

BACKGROUND ART

There exists today many competing forms of communication systems ranging from cellular mobile telephones through trunking radio systems and on to more specialised forms of network such as the DGPS network and the CT1, CT2, CT3 or DECT systems.

It is an object of the present invention to provide hand held access to more than one of these systems via a single hand held unit.

DISCLOSURE OF THE INVENTION

Accordingly, in one broad form of the invention, there is provided a multi-mode communications system including a hand held phone module and incorporating means allowing selection of one from a multiple of available modes of operation.

Preferably, the modes of operation comprise different forms of network communications protocols and standards.

In a preferred form of the invention, the communications protocols and standards are selected from:  
cellular telephone (all standards including but not limited to GSM, E-GSM, P-GSM, PCM, AMPS, ETACS, NMT450);

trunking radio system (TRS);  
DGPS network;  
cordless localised access networks including CT1, CT2,  
CT3 and DECT.

5 Preferably said means allowing selection comprises a  
base unit in communication with said hand held phone module.

Preferably said base unit includes a system controller  
adapted for communication with at least a keypad portion of  
said hand held phone module.

10 In one particular form of the invention the system  
controller communicates with said keypad portion via a serial  
interface. In an alternative preferred form said system  
controller communicates with said keypad via a cordless  
communication protocol selected from CT1/CT2/CT3 and DECT.

15 Preferably communications between said system  
controller and said keypad are at relatively low power and  
said base unit incorporates booster means for issuing a high  
power communications signal.

In a particular preferred form said base unit is  
20 incorporated within said hand held phone module. In a  
further particular preferred form the modes of operation  
thereof are limited to selection between cellular phone and  
trunked radio.

#### BRIEF DESCRIPTION OF THE DRAWINGS

25 Embodiments of the invention will now be described with  
reference to the accompanying drawings wherein:-

Fig. 1 is a block diagram of a base unit and  
handset according to a first embodiment of

the invention,

- Fig. 2 is a diagram of the base unit and handset of Fig. 1 in a first mode of operation,
- Fig. 3 is a diagram of the base unit and handset of Fig. 1 according to a second mode of operation,
- 5 Fig. 4 is a diagram of the base unit and handset of Fig. 1 according to a third mode of operation,
- Fig. 5 is a diagram of the base unit and handset of Fig. 1 according to a fourth mode of operation,
- 10 Fig. 6 is a diagram of at least portions of a base unit and handset incorporated into a single casing in accordance with a second embodiment of the invention,
- 15 Fig. 7 is a block diagram of a base unit according to a third embodiment of the invention,
- Fig. 8 is a block diagram of a hand set usable with any embodiment of the invention,
- 20 Fig. 9 is a logic diagram of the operation of the hand set of Fig. 8,
- Fig. 10 is a block diagram of a further example of the invention,
- 25 Fig. 11 is a block diagram of a further example of the invention,
- Fig. 12 is a block diagram of a further example of the invention, and

Fig. 13 is a logic diagram of an automatic switchover system.

#### MODES FOR CARRYING OUT THE INVENTION

A multi-mode communication system according to a first embodiment of the invention comprises a base unit 10 in communication with a handset 11.

The base unit 10 includes system controller 12 in bidirectional communication with a cellular phone booster 13, a trunking radio booster 14, a trunking RF/digital MPT 1327 module 15, a cellular modem/paging module 16, a DGPS module 17, CT1/CT2/CT3 interface module 18 and display 19. Aerial 20 transmits/receives signals for either one of cellular phone booster 13 or trunking radio booster 14. One or other booster is switched for communication with aerial 20 by means of electronic switch 21. In an alternative form each booster has its own dedicated aerial (not shown).

It will be appreciated that the various modules will produce signals for transmission/reception on antenna 20 according to different formats and protocols and often for transmission/reception on different carrier frequencies. It is the task of system controller 12 to switch the different modules into operation according to the needs of an operator of handset 11 as communicated from the keypad 22 of the handset 11.

The handset 11 can comprise a cellular phone handset and cradle 11A or a cordless handset 11B. In this instance, the cellular phone and cradle combination 11A can communicate with system controller 12 via a plug-in wire link

communicating with a serial interface port 23 on the cellular phone.

The cordless handset 11B communicates with system controller 12 via the CT1/CT2/CT3 interface 18.

5           In either case, in use, an operator of the handset 11 communicates a desired mode of operation to system controller 12 by depressing appropriate function keys on keypad 22. The mode selected can be confirmed to the user by display of an appropriate message on a display 24 associated with the  
10 keypad 22 on the handset 11. The intention is that the communications link 25 from handset 11 to system controller 12 is or need only be a low power, short range link.

          Furthermore, in a particular implementation, the handset 11 comprises a cellular telephone handset adapted for  
15 operation on the cellular telephone network without utilisation of communications link 25. However, where a boosted communications signal in cellular telephone mode is required or where it is required to communicate in a mode other than cellular telephone mode - for example on the  
20 trunked radio system then the communications link 25 is utilised to communicate to systems controller 12 via keypad 22 the desired mode of operation. In this mode of operation the cellular phone uses the base unit 10 as a local relay station.

25           Exemplary modes of operation of the communications system according to a first embodiment of the invention will now be described with reference to Figs. 2, 3, 4 and 5.

          In a first mode of operation as illustrated in Fig. 2 a

normal cellular telephone is used to provide a hands free  
cellular phone with optional power amplifier booster in the  
form of base unit 10. The DGPS module 17 and cellular modem  
16 can also be brought into operation via system controller  
5 12 to provide positional information to a user of handset 11.

With reference to Fig. 3 a second mode of operation is  
illustrated where a normal cellular telephone is used as  
handset 11 to provide communication with the trunked radio  
system. Hands free operation is possible utilising the hands  
10 free mode, where provided, on the cellular telephone. Again,  
the DGPS module 17 can be connected into the system to  
provide positional information. The system can be either  
duplex or simplex in operation.

Fig. 4 illustrates a third mode of operation wherein  
15 the handset 11 comprises a cellular phone switchable to  
trunking radio mode by operation of appropriate function keys  
on keypad 22. In this case the trunking radio booster 14 is  
switched into circuit to provide power amplification whilst  
the DGPS module 17 is utilised to provide position  
20 information for display on display 24.

Fig. 5 illustrates a fourth mode of operation wherein  
handset 11 is implemented as a cordless mobile telephone  
handset in cordless communication with system controller 12  
via a CT1/CT2/CT3 interface 18. Once again, the cordless  
25 handset can operate as a cellular mobile telephone or  
alternatively it can communicate with system controller 12 so  
as to provide access to the trunked radio network in either  
the duplex or simplex mode.



-7-

In its most straightforward implementation the handset 11 is implemented as a conventional cellular telephone handset incorporating software modifications which permit communication via a serial interface port 23 or via a CT1/CT2/CT3 interface module 18 with a locally located system controller within a base unit 10. In this manner the cellular phone can operate normally as a cellular phone or alternatively can provide access to the facilities incorporated within base unit 10, most preferably at least including a trunked radio module 15 with trunking radio booster 14.

With reference to Fig. 6 selected portions of the base unit 10 illustrated and described with reference to Fig. 1 can be incorporated within a cellular telephone casing to provide a single hand held dual mode communications device adapted for communication with either the cellular telephone network or with the trunked radio network.

In the embodiment illustrated in Fig. 6 a mobile telephone casing 26 incorporates the conventional components of a cellular telephone 27 together with the relevant components from base unit 10 which provide access to the trunked radio network including trunking RF/digital MPT1327 module 15 and trunking radio booster 14. In this manner dual mode cellular telephone and trunked radio network mode operations are provided within the one hand held phone module. Other elements from base unit 10 can be incorporated including CT1/CT2/CT3 or DECT interface module 18 allowing operation of the hand held phone module in CT1/CT2/CT3 or

DECT mode as well.

With reference to Fig. 7 a base unit 110 according to a third embodiment of the invention is illustrated in block diagram form. The modules within the base unit 110 include  
5 the following:

- (i) Cellular Phone Module III meeting one or more of the following standards - GSM, E-GSM, P-GSM, PCN, AMPS, ETACS, NMT450, CDMA. The digital board and RF board for the cellular phone will be included  
10 in the radio system. Interface to the digital board is via an external communications interface, for controlling call setup and receive.
- (ii) DGPS module 112 - The DGPS module provides  
15 geodetic information at the multi-mode radio system, for use either by the multi-mode radio system or at a remote location. The DGPS module may accept DGPS correction information to provide higher accuracy.
- (iii) Trunking Radio module 113 meets the MPT1327 or  
20 any other standard for trunking radio. The trunking radio module includes the RF and digital sections of an MPT1327 trunking radio. Interface to the trunking radio module may be via an  
25 external communications interface for controlling call setup and receive.
- (iv) Trunking Radio booster 114. The trunking radio booster module may be used to amplify the MPT1327

trunking radio signal to increase the range and reception of the trunking radio module.

(v) Cellular Phone booster 115. The cellular phone booster module may be used to amplify the  
5 cellular phone signal to increase the range and reception of the cellular phone module.

The data communication between the modules in the multi-mode radio system module of Fig. 7 may be via a serial communication protocol or a parallel communication protocol.  
10 An audio interface may also be connected between the system controller, cellular phone module, trunking radio module and cordless communication base station.

A serial interface may be provided to the DGPS module 112 to allow information to be passed to and from the DGPS  
15 module and the system controller and other communications modules.

A data interface and an audio interface may be connected between the system controller and the paging module to allow both data messages and audio messages to be passed  
20 from the paging module to the system controller.

A data interface and an audio interface may be connected between the system controller and the cordless communication base station to allow call setup information (data), keypress information (data), LCD display information  
25 (data) and audio to be passed between the cordless communication base station and the system controller.

In addition the base unit 110 includes a paging module 116, a cordless communication base station 117 (CT1, CT2,

CT3, DECT or similar) and a cellular modem 118, all in communication with system controller 119.

The manner of operation of the base unit 110 is the same as that in respect of the base unit 10 according to the  
5 first embodiment of the invention.

The base unit 110 can be utilised in conjunction with a handset as previously described so as to operate in at least two modes of operation as follows:-

In a first mode the handset is used to select cellular  
10 telephone operation. That call is then initiated by the user with the handset. The system controller in the multi-mode radio system controller switches the audio and data interface to the cellular phone module within the system. A call is then initiated over the cellular phone communication protocol  
15 to the public network. The cellular phone booster may be used to increase the gain of the signal transmitted. The DGPS module and cellular modem may also be used to pass geodetic information across the cellular network. The cellular phone communication protocol may be compliant to one  
20 of the following standards, AMPS, ETACS, GSM, CDMA, TDMA, DCS-1800, NMT450.

In a second mode of operation the handset is utilised to select trunking radio operation whereby the trunking radio module 113 in the base unit 110 is utilised to enable  
25 communications over a trunking radio network, for example, compliant to MPT1327.

As earlier described with reference to Fig. 6 it is possible to incorporate at least portions of a base unit and

-11-

handset into a single casing. A dual mode handset 121 operable according to the block diagram of Fig. 8 will now be described.

The dual mode handset 121 can incorporate technology from any two of the following communication protocols: GSM, MPT1327, Trunking Radio, AMPS, ETACS, TDMA, CDMA, PCN, CT1, CT2, CT3, DECT.

With the advent of cordless office applications and constant contactability demands, there is a requirement for a single handset that offers the flexibility of addressing the requirements for more than one communications protocol.

The different communications protocols offer a variety of applications. For example the trunking radio system is typically associated with fleet and industrial applications. The GSM, AMPS, ETACS, TDMA and CDMA networks, are typically focused towards the business, corporate and consumer markets. The CT1, CT2 and CT3 technologies are most commonly associated with cordless office applications. These requirements often overlap so there exists an application for a handset that services more than one of these requirements.

The dual mode handset 121 of Fig. 8 comprises a mode 1 digital module 122 and a mode 2 digital module 123. Each module is adapted to operate according to a particular, but different communications protocol or "mode" as compared with the other module 122, 123. The handset 121 additionally includes an RF portion 124 specific to mode 1 and an RF portion 125 specific to mode 2. Both these RF portions are

driven from a generic radio frequency module 126. In addition the handset includes a display 127, a keypad 128, and memory peripherals 129. The components 127, 128 and 129 are common to both modes of operation of the handset 121.

5           The first mode of the handset may be any of the above mentioned technologies. The second mode of the handset may also be any of the above mentioned technologies.

          The radio frequency modules of the two modes may be partially or wholly combined to reduce the required circuitry  
10       for the handset.

          Separate digital modules may be maintained to ensure correct operation of the handset under each mode. The digital module of each mode, may include a microprocessor and any integrated circuitry specific to the mode of operation  
15       i.e. Channel coder/decoder for a GSM digital module.

          The handset may change modes from one mode to the other by specified functions on the keypad, or by the selection of one of a number of menu functions.

          The necessary software for both the modes of operation  
20       will be contained in the one handset. Some portions of software may be common to both the modes including the man machine interface, and the software for the control of common hardware components.

          The handset may dynamically switch a call made in one  
25       mode to the second mode, by holding the current call until the call is re-established, using the second mode. Alternatively, the handset may cancel the first call and automatically re-establish using the second mode.

The handset may accept specified incoming call messages indicating that a second dual mode handset is currently switching mode.

The manner of operation of the dual mode handset 121 is generally in accordance with that described in respect of Fig. 6. A detailed logic flow diagram of the automatic switchover operation is provided in Fig. 9 where mode 1 operation is defined as CT2 operation and mode 2 operation is defined as GSM operation.

It will be appreciated that these modes are merely exemplary and other operational modes, as earlier listed, can be utilised in substitution for either the CT2 or GSM modes of operation.

The controllers incorporated in the embodiments of the invention described thus far can include additional software or logic which permits monitoring of signal strength and the like for the purpose of initiating compensating action. In its simplest form as previously described a booster can be switched in. In a more complex form as to now be described in more detail a switchover between modes can be performed.

With reference to Fig. 13 a call may be being carried in "mode 1" to handpiece 211. Logic within system controller 212 monitors changes in signal strength and the like. A reduction in signal strength can be interpreted as a failure condition or the approach of a failure condition whereupon controller 212 will initiate a separate call to the same number in an alternative mode of operation (in this case "mode 2"). If the mode 2 call is successful then controller

212 simply transfers the connection of handpiece 211 across  
to the mode 2 connection and disconnects the mode 1  
connection. Corresponding monitoring is done of the mode 2  
connection and, should a failure condition be detected then a  
5 corresponding attempt will be made to reinitiate a mode 1  
connection and transfer.

Alternatively a user, via the keypad 213 can initiate a  
request for transfer of mode.

Figs. 10, 11 and 12 provide particular examples of this  
10 automatic switchover facility.

Fig. 10 is a block diagram of another method of the  
invention using a trunking radio module to invoke  
communications over a trunking network compliant to MPT 1327  
and/or APC 025 when finalised or becomes a standard but not  
15 limited to those standards. The cordless or corded handset  
150 communicates with controller 212. If the user is on the  
AMPS cellular network and the network no longer has good  
cover due to the lack of cells or no cells being available,  
the handset will automatically redial the number and make  
20 connection. As an alternative, the controller 212 will  
identify the signal weakening and redial, hold the call and  
connect seamlessly via the trunking network if available.

Fig. 11 is a block diagram of another method of the  
application of the automatic switchover facility in which the  
25 subscriber is communicating via the CT2 cordless mode as the  
subscriber moves out of range. The CT2 handset has the  
capability of changing mode from CT2 to the GSM network in  
the manner described with reference to Fig. 9. The



-15-

handset and/or the controller 212 will hold the call whilst  
redialling and reconnecting the two calls seamlessly as  
described with reference to Fig. 13. A special code may be  
transmitted to allow the previous call to be rerouted prior  
5 to the handset accepting new calls.

Fig. 12 is a block diagram of a further application of  
the automatic switchover facility which allows the subscriber  
to initiate a change from the CT2 mode to, say, the GSM mode  
by pressing a function button and the handset controller  
10 which will automatically dial up the GSM network and re-route  
the two calls seamlessly. The re-routing will also carry  
special identification allowing the base unit or handset at  
the other end to know it is a re-routed call and to accept  
the call.

#### 15 INDUSTRIAL APPLICABILITY

The invention is applicable in the fields of wireless  
and mobile telecommunications.

CLAIMS

1. A multi-mode communications system including a hand held phone module and incorporating means allowing selection of one from a multiple of available modes of operation.
2. The system of claim 1 wherein said modes of operation comprise different forms of network communications protocols and standards.
3. The system of claim 2 wherein said communications protocols and standards are selected from:
  - cellular telephone (all standards including but not limited to GSM, E-GSM, P-GSM, PCM, AMPS, ETACS, NMT450);
  - trunking radio system (TRS);
  - DGPS network;
  - cordless localised access networks including CT1, CT2, CT3;
4. The system of any previous claim wherein said means allowing selection comprises a base unit in communication with said hand held phone module.
5. The system of claim 4 wherein said base unit includes a system controller adapted for communication with at least a keypad portion of said hand held phone module.

6. The system of claim 5 wherein said system controller communicates with said keypad portion via a serial interface.

7. The system of claim 5 wherein said system controller communicates with said keypad via a cordless communication protocol selected from CT1/CT2/CT3 or DECT.

8. The system of claim 5 or 7 wherein communications between said system controller and said keypad are at relatively low power and said base unit incorporates booster means for issuing a high power communications signal.

9. The system of any one of claims 4 to 8 wherein said base unit is incorporated within said hand held phone module.

10. The system of any one of claims 3 to 9 wherein the modes of operation thereof are limited to selection between cellular phone and trunked radio.

11. The system of any previous claim wherein said system is housed within a single enclosure.

12. The system of any previous claim incorporating an automatic switchover facility (as defined in the specification).

13. A dual mode handset adapted to be switched by a user between two modes of operation.

14. The handset of claim 13 wherein said modes of operation are selected from GSM, MPT1327, Trunking Radio, AMPS, ETACS, TDMA, CDMA, PCN, CT1, CT2, CT3, DECT.

15. The handset of claim 13 or claim 14 incorporating an automatic switchover facility.

1/12

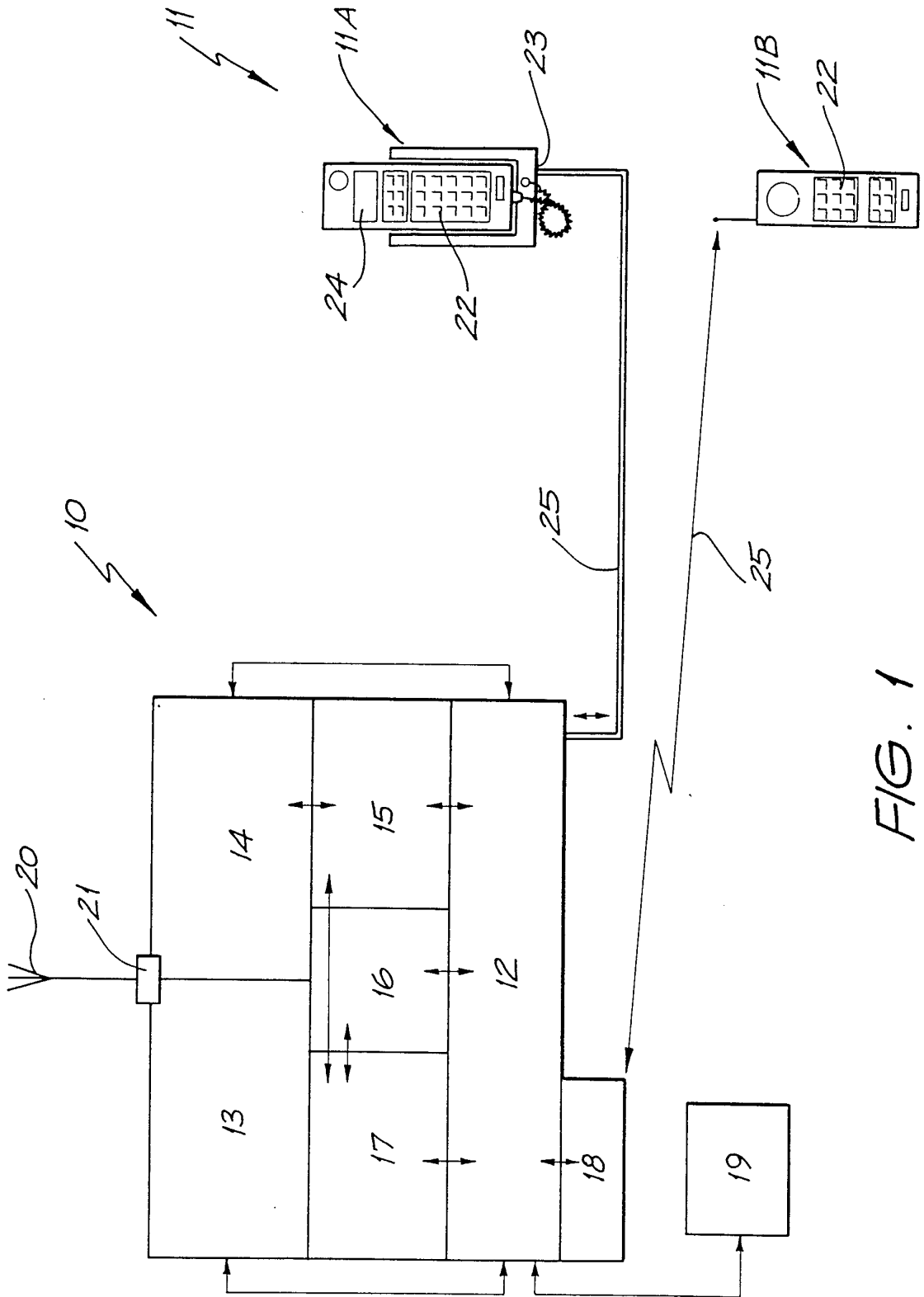

FIG. 1

2/12

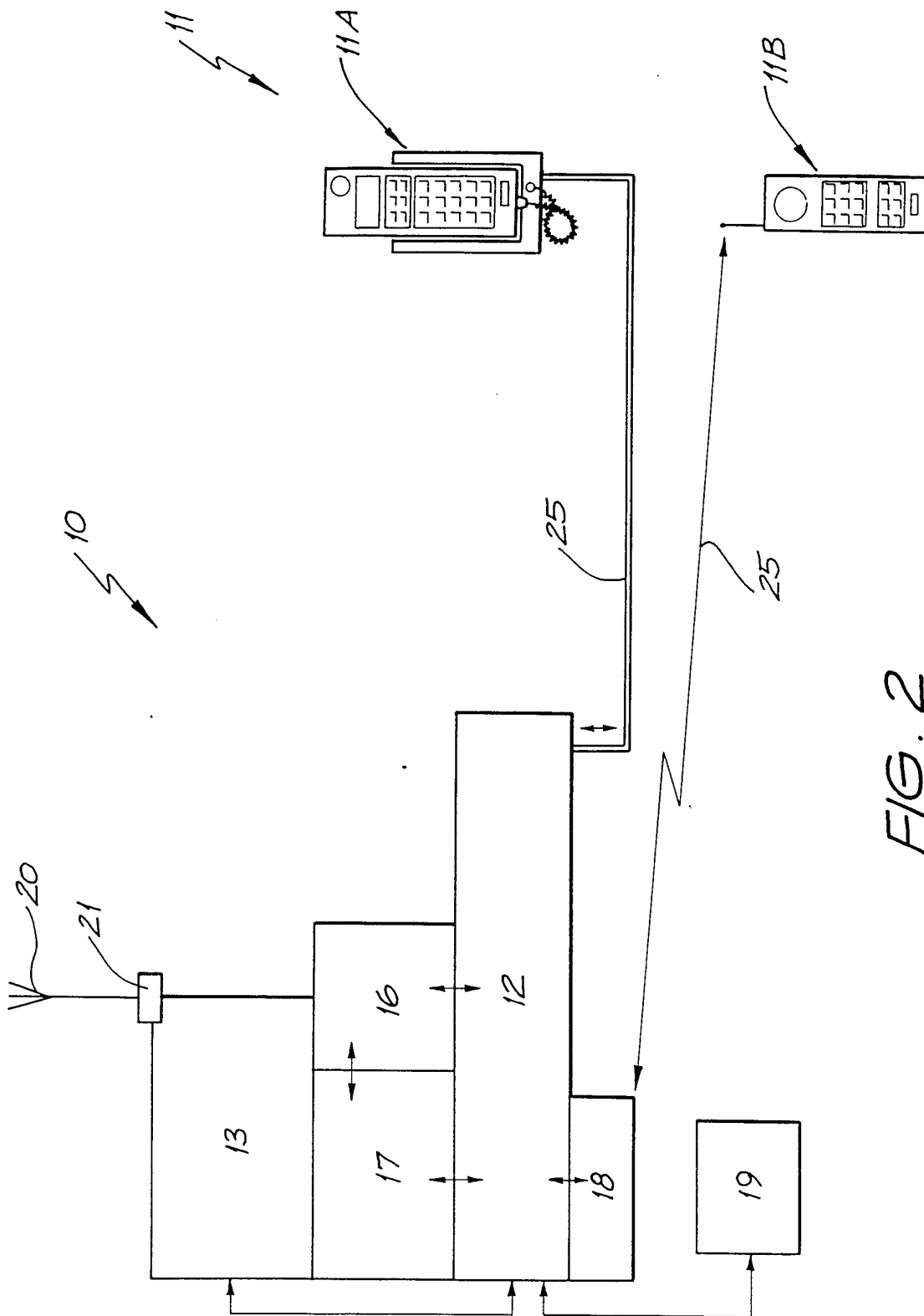

FIG. 2

3/12

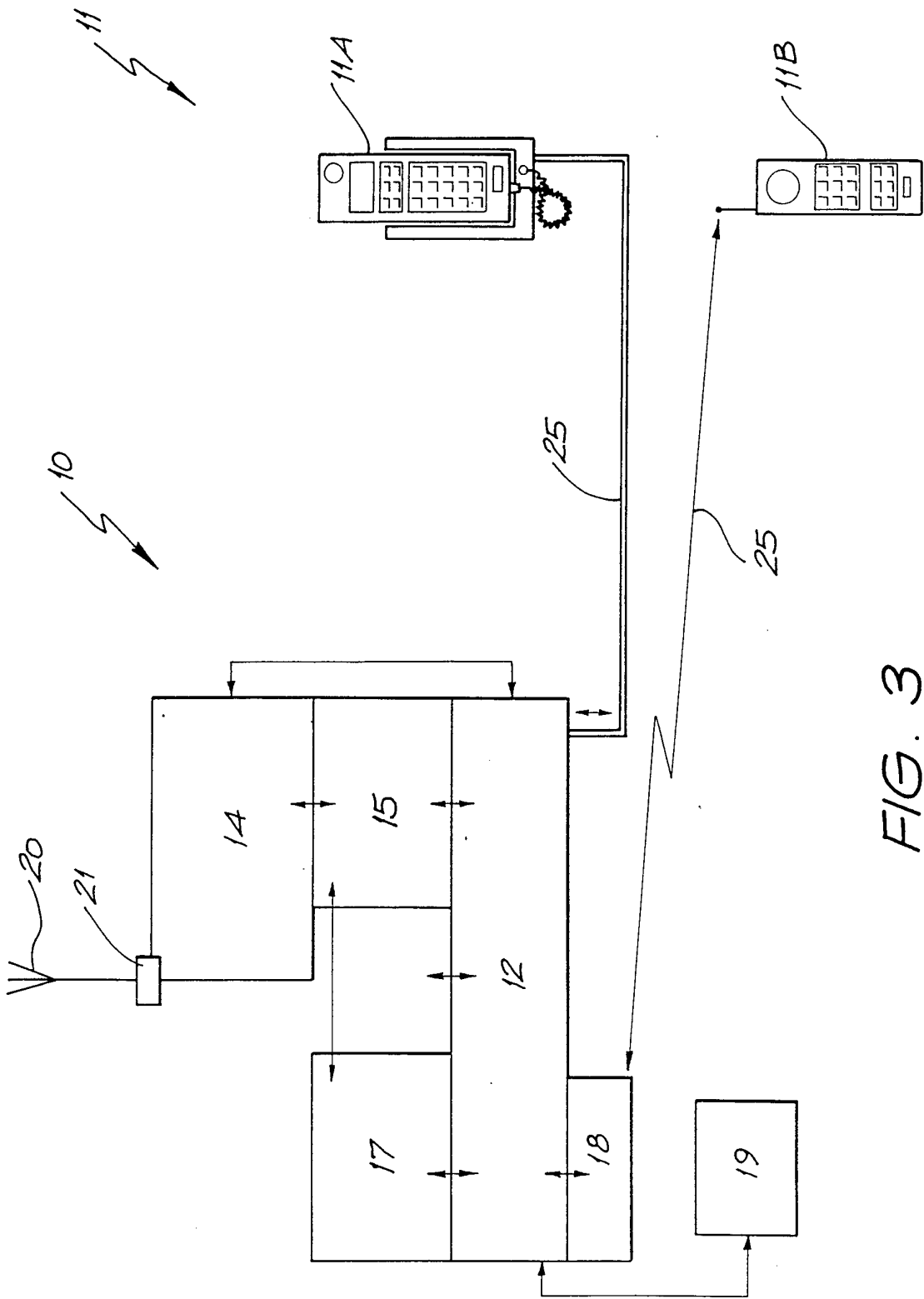

FIG. 3

4/12

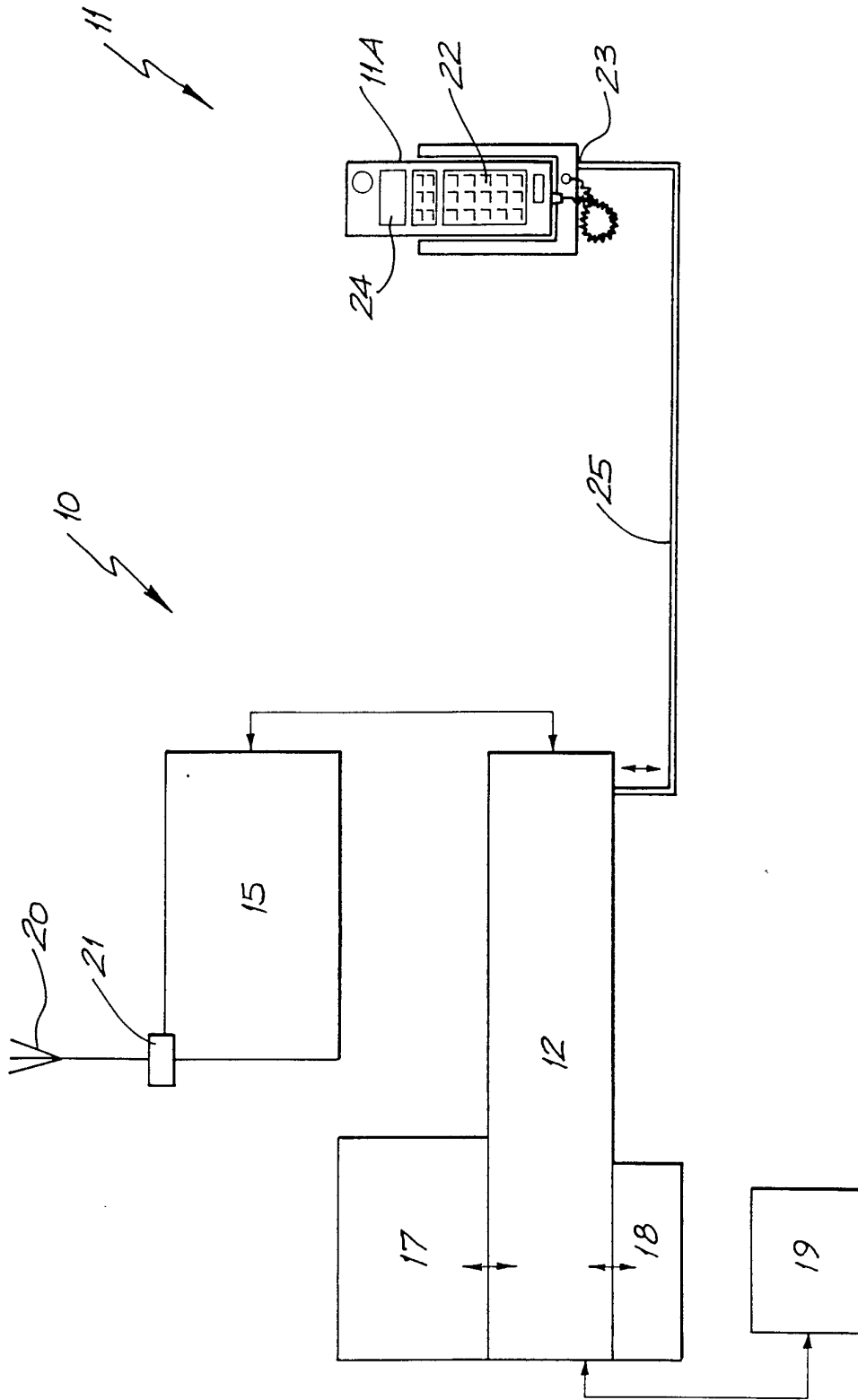

FIG. 4



5/12

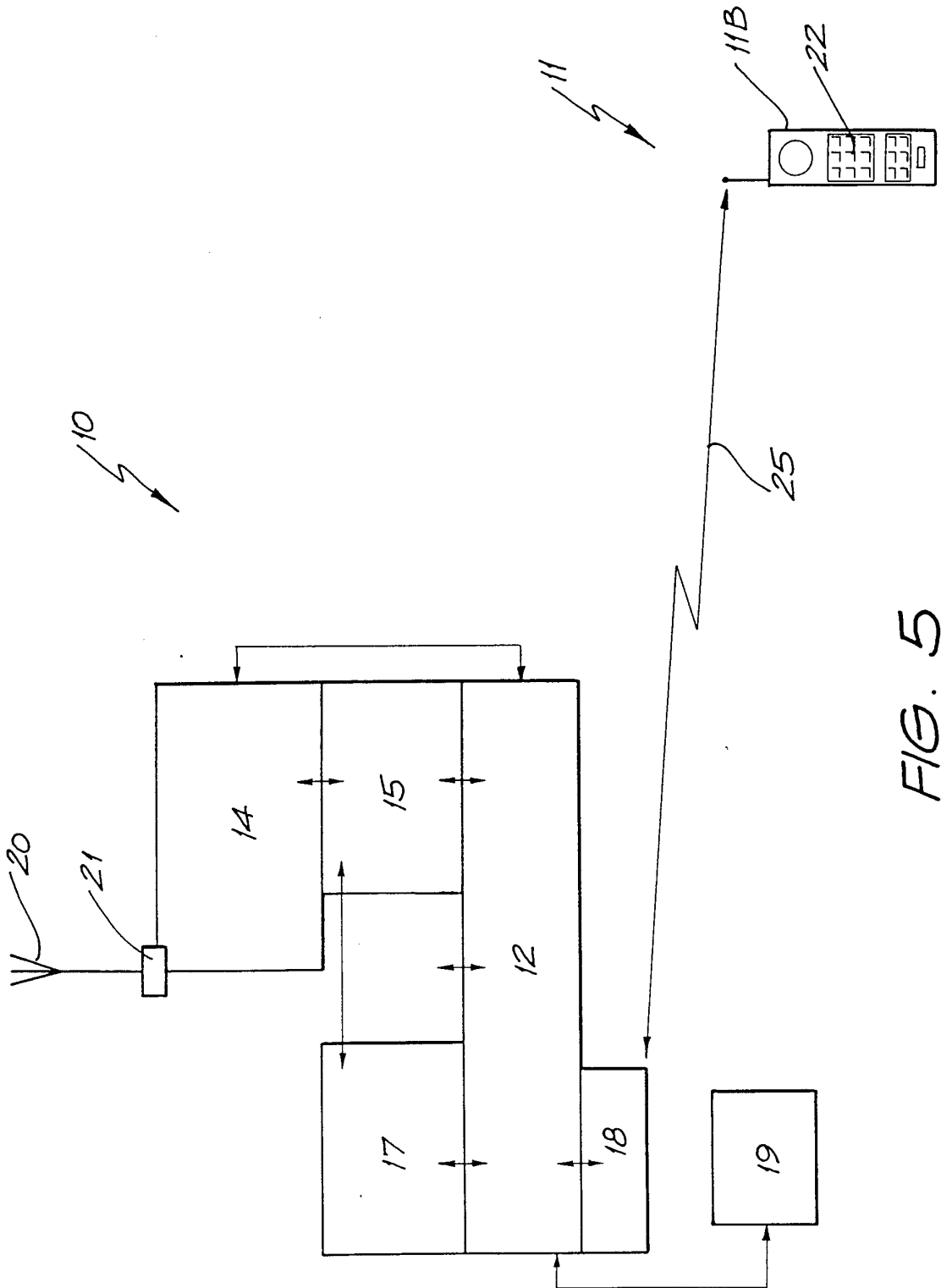

FIG. 5

6/12

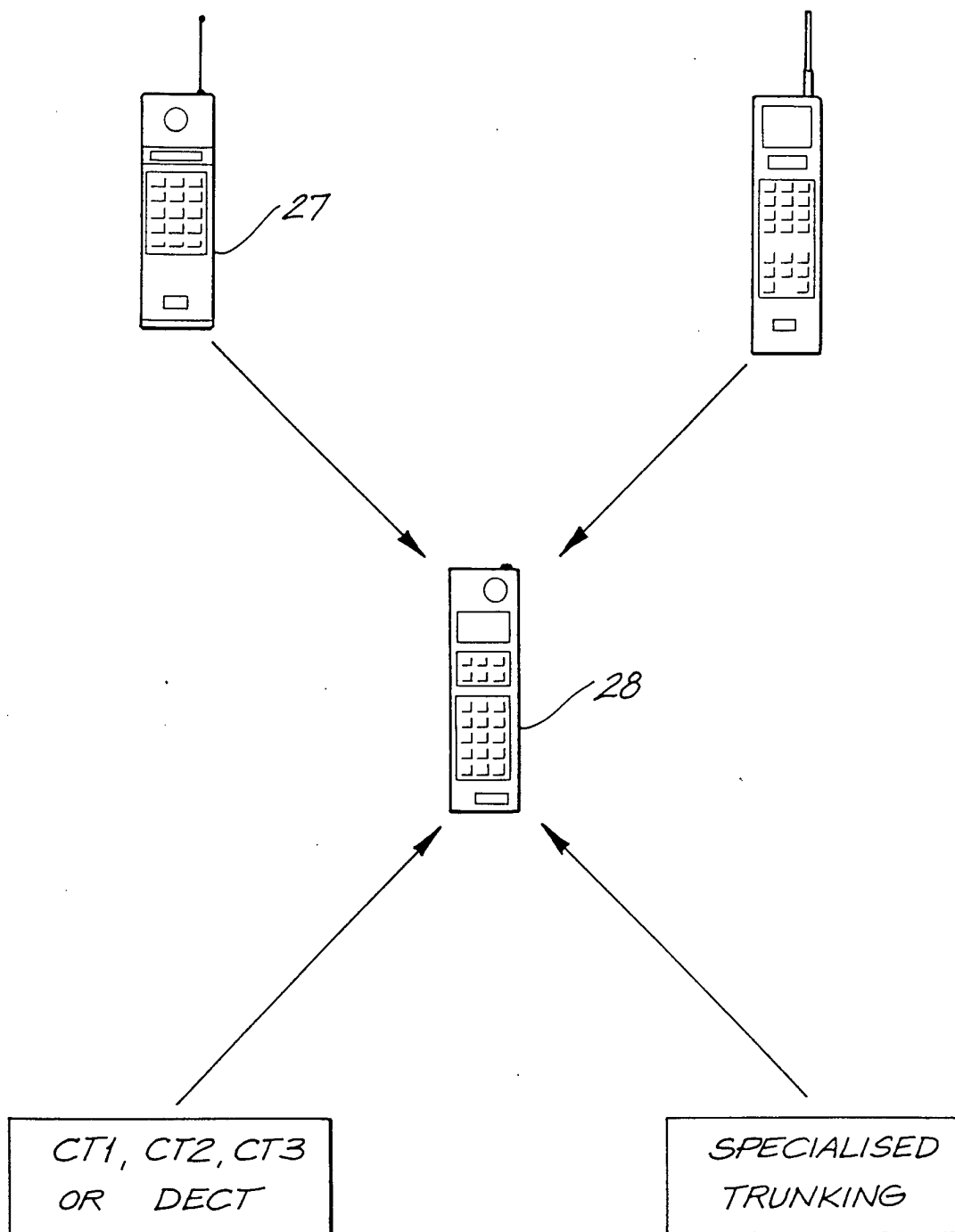

FIG. 6

7/12

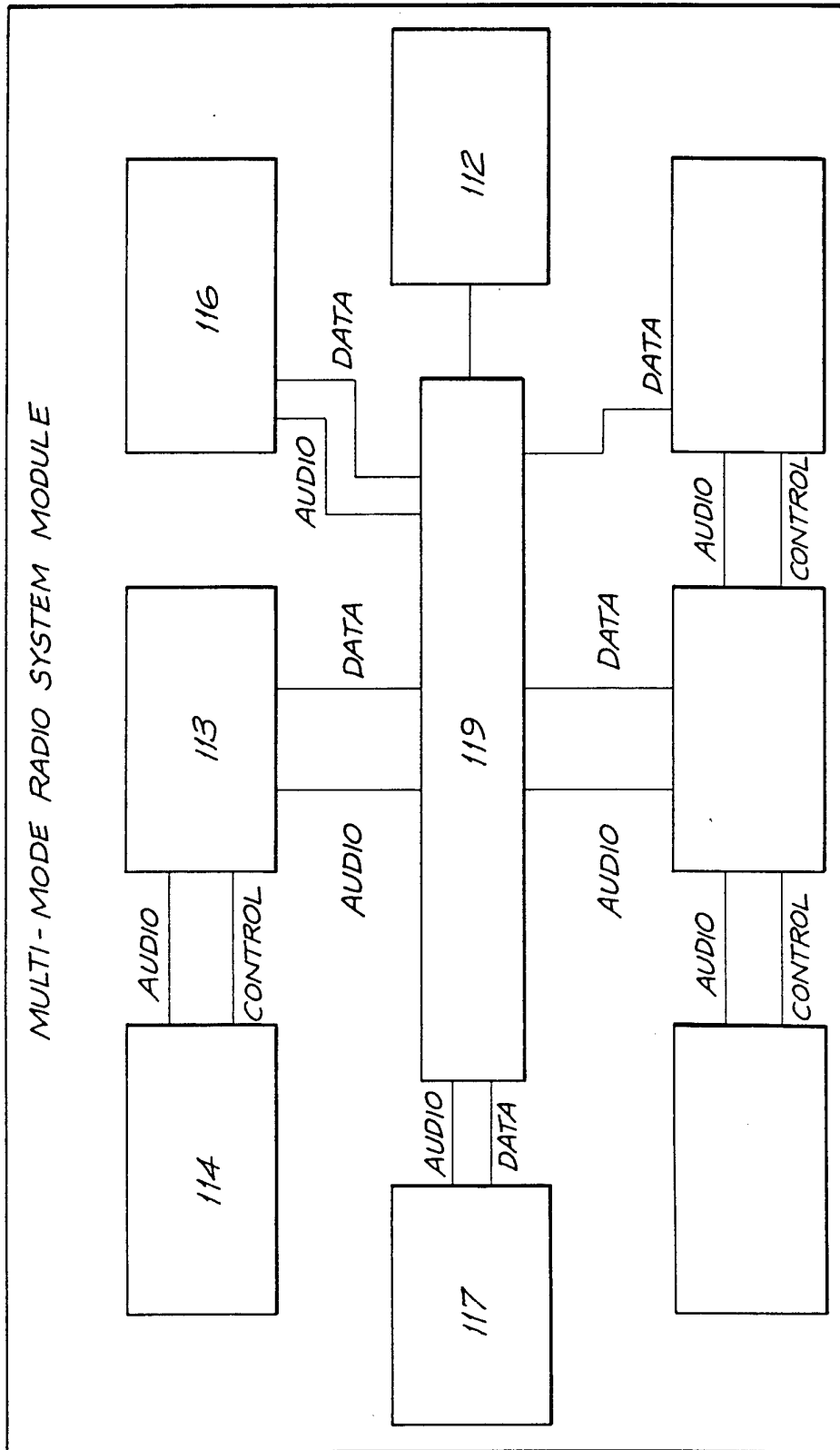

FIG. 7

110

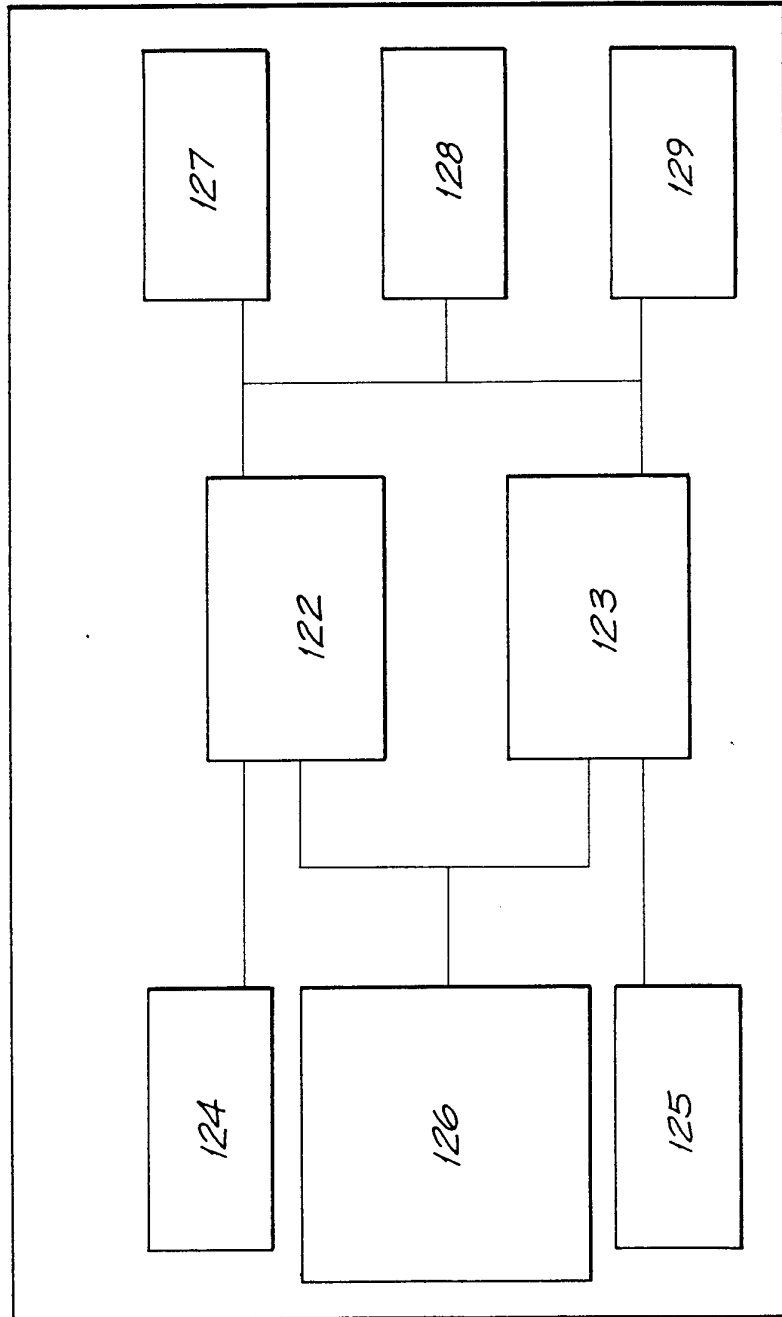

FIG. 8

121

9/12

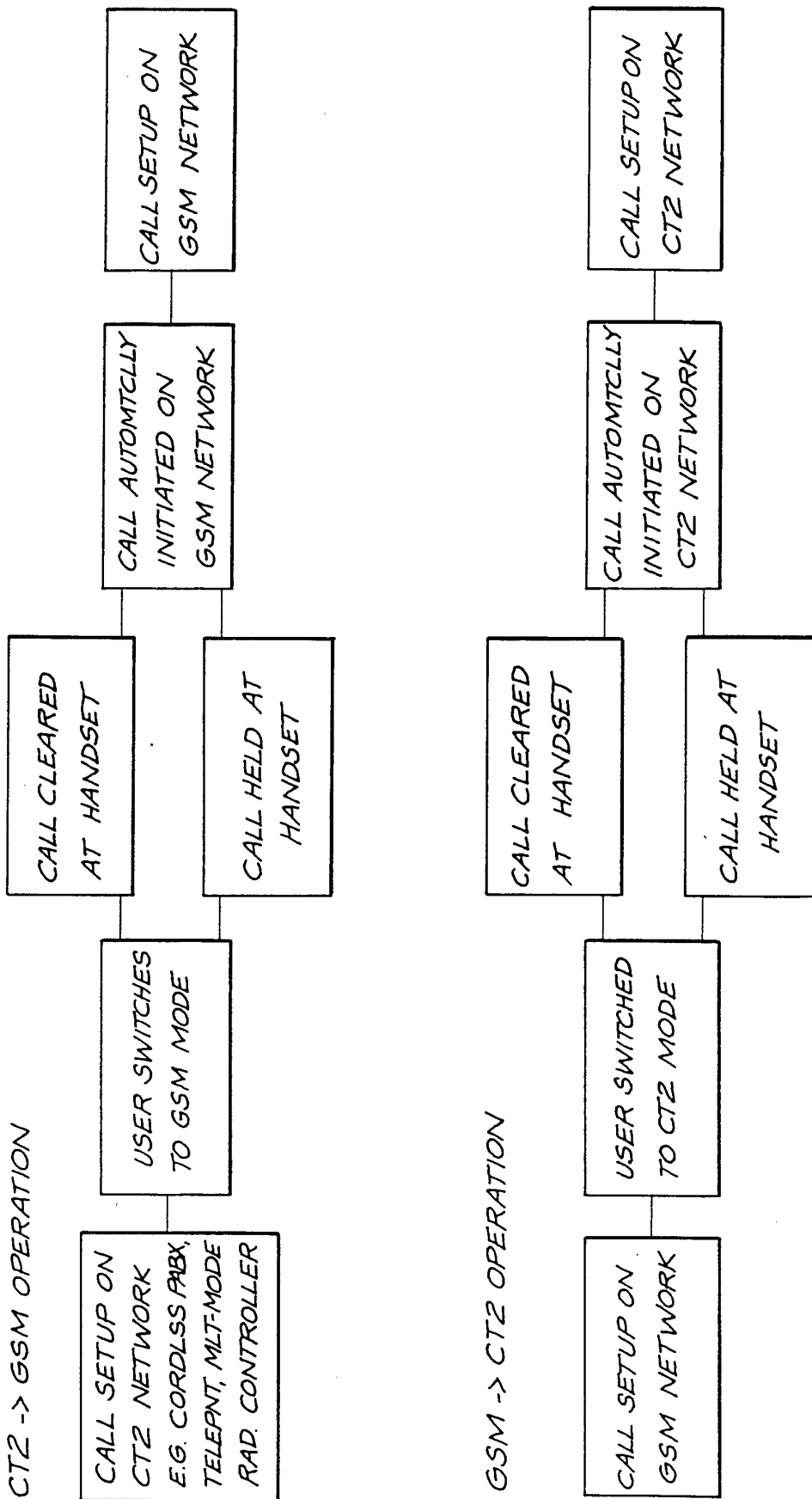

FIG. 9

10/12

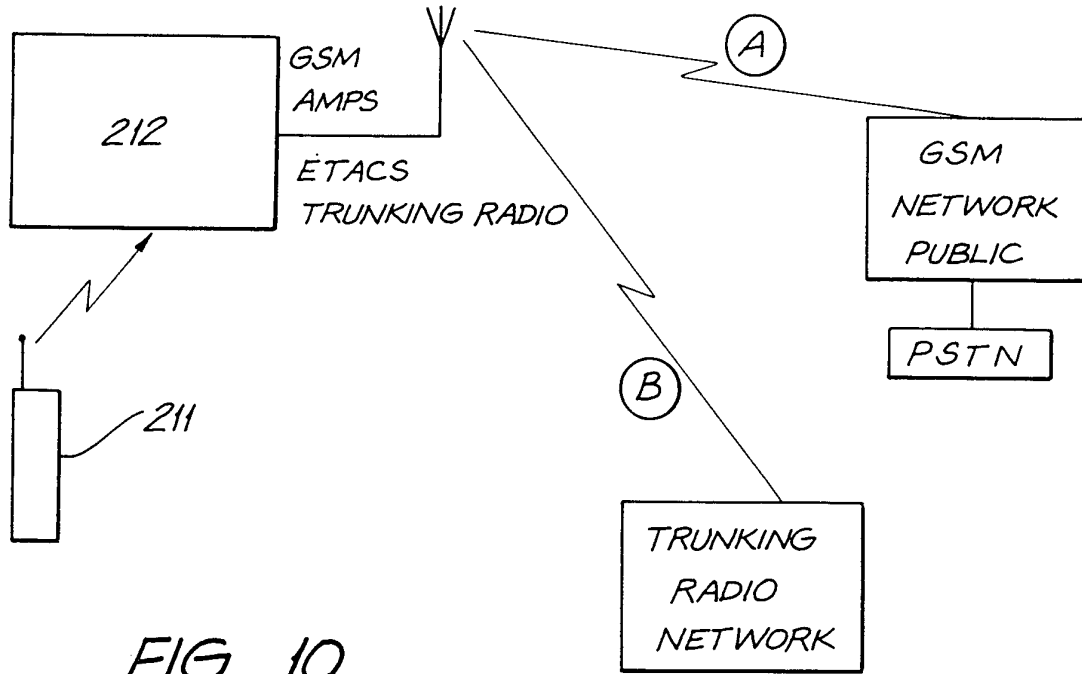

FIG. 10

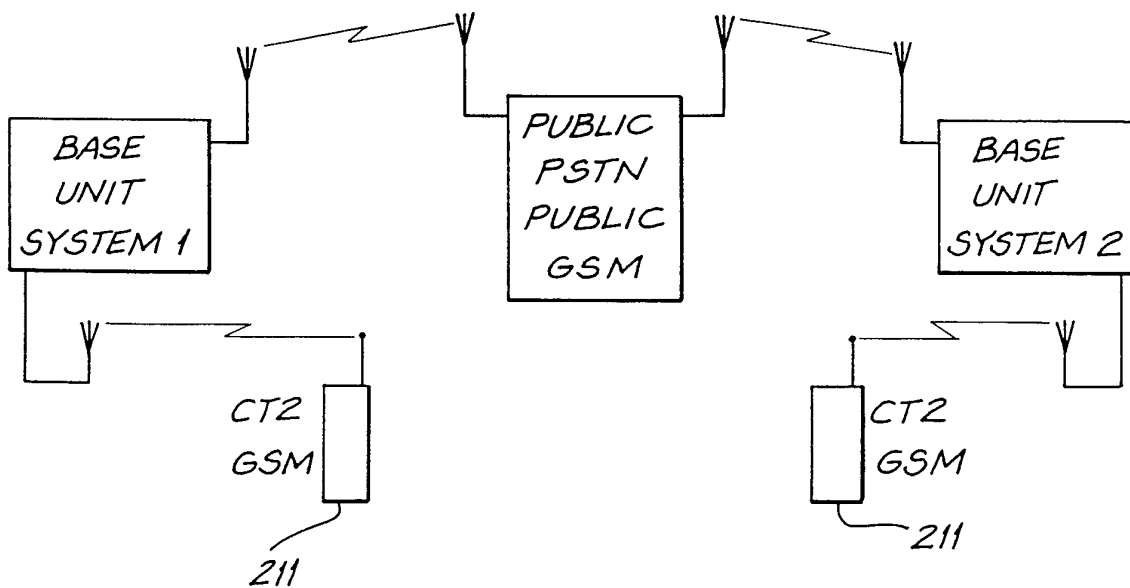

FIG. 11

11/12

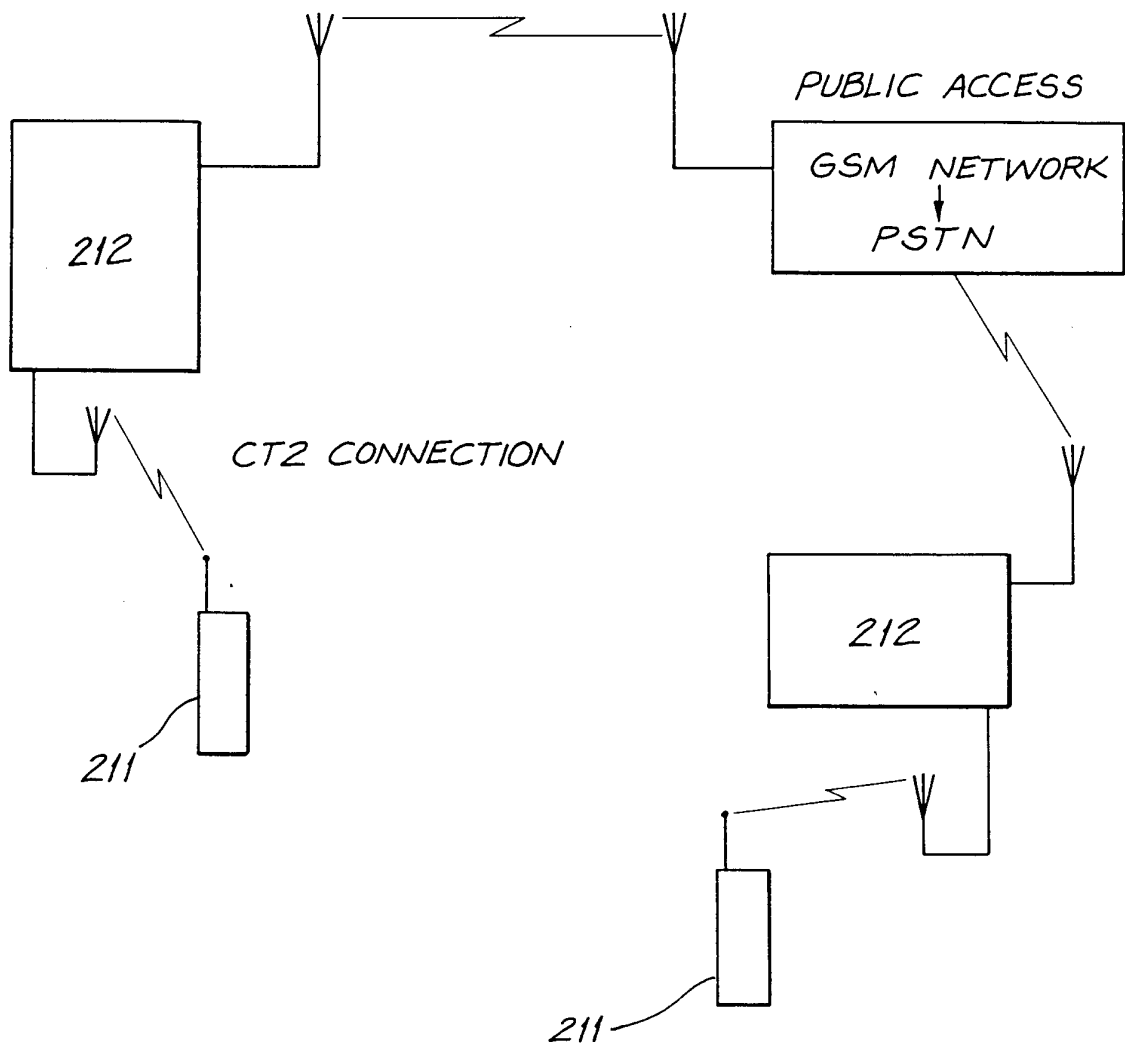

FIG. 12

12/12

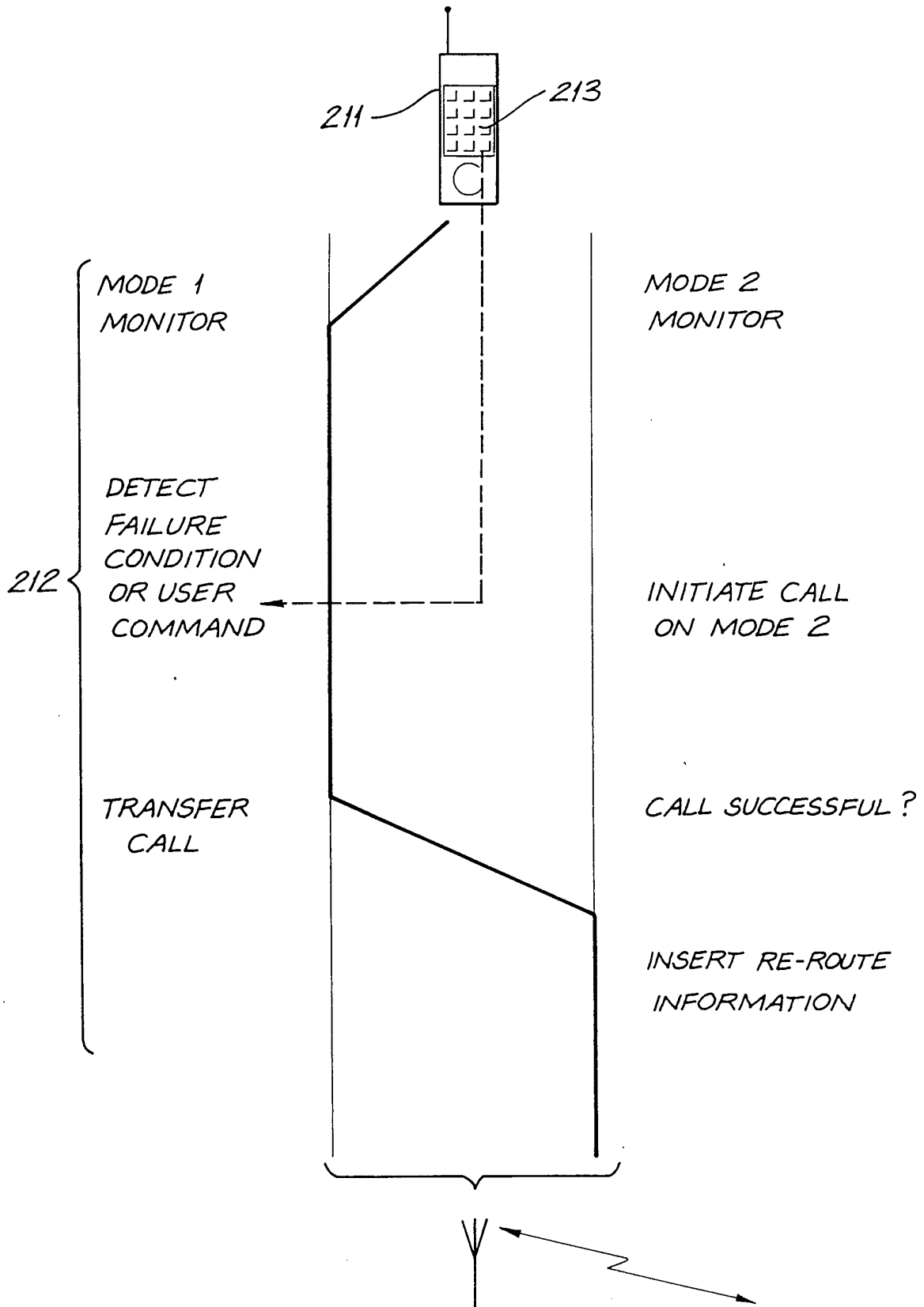

FIG. 13



<b>A. CLASSIFICATION OF SUBJECT MATTER</b> Int. Cl. <sup>6</sup> H04Q 7/20  According to International Patent Classification (IPC) or to both national classification and IPC		
<b>B. FIELDS SEARCHED</b>  Minimum documentation searched (classification system followed by classification symbols) IPC : H04Q 7/20 7/22 7/28 7/32 H04B 7/26 7/005 H04Q 7/00 7/02 7/04  Documentation searched other than minimum documentation to the extent that such documents are included in the fields searched  Electronic data base consulted during the international search (name of data base, and where practicable, search terms used) WPAT, JAPIO, JOPAL		
<b>C. DOCUMENTS CONSIDERED TO BE RELEVANT</b>		
Category *	Citation of document, with indication, where appropriate, of the relevant passages	Relevant to Claim No.
X	US 5228074 A (MIZIKOVSKY) 13 July 1993 Column 2 lines 21/41 Column 3 lines 8/17 Column 4 lines 42/49, 61/68 Column 7 line 15 Column 8 line 21/30 Column 9 line 8 Column 10 lines 3/6 Column 15 lines 14/17	1-11, 13-15
<input checked="" type="checkbox"/> Further documents are listed in the continuation of Box C.		
<input checked="" type="checkbox"/> See patent family annex.		
* Special categories of cited documents :		
"A"	document defining the general state of the art which is not considered to be of particular relevance	"T" later document published after the international filing date or priority date and not in conflict with the application but cited to understand the principle or theory underlying the invention
"E"	earlier document but published on or after the international filing date	"X" document of particular relevance; the claimed invention cannot be considered novel or cannot be considered to involve an inventive step when the document is taken alone
"L"	document which may throw doubts on priority claim(s) or which is cited to establish the publication date of another citation or other special reason (as specified)	"Y" document of particular relevance; the claimed invention cannot be considered to involve an inventive step when the document is combined with one or more other such documents, such combination being obvious to a person skilled in the art
"O"	document referring to an oral disclosure, use, exhibition or other means	"&" document member of the same patent family
"P"	document published prior to the international filing date but later than the priority date claimed	
Date of the actual completion of the international search 4 April 1995 (04.04.95)		Date of mailing of the international search report 28 APRIL 1995 (28.04.95)
Name and mailing address of the ISA/AU AUSTRALIAN INDUSTRIAL PROPERTY ORGANISATION PO BOX 200 WODEN ACT 2606 AUSTRALIA  Facsimile No. 06 2853929		Authorized officer  R. STOPFORD  Telephone No. (06) 2832177

<b>Box I</b>	<b>Observations where certain claims were found unsearchable (Continuation of Item 1 of first sheet)</b>
<p>This international search report has not established in respect of certain claims under Article 17(2)(a) for the following reasons:</p>	
1.	<input type="checkbox"/> Claims Nos.: because they relate to subject matter not required to be searched by this Authority, namely:
2.	<input checked="" type="checkbox"/> Claim Nos.: 12 because they relate to parts of the international application that do not comply with the prescribed requirements to such an extent that no meaningful international search can be carried out, specifically:  Rule 6.2(a) reference by the claim in respect of a technical feature of the claim to the description.
3.	<input type="checkbox"/> Claims Nos.: because they are dependent claims and are not drafted in accordance with the second and third sentences of Rule 6.4(a).
<b>Box II</b>	<b>Observations where unity of invention is lacking (Continuation of item 2 of first sheet)</b>
<p>This International Searching Authority found multiple inventions in this international application, as follows:</p>	
1.	<input type="checkbox"/> As all required additional search fees were timely paid by the applicant, this international search report covers all searchable claims
2.	<input type="checkbox"/> As all searchable claims could be searched without effort justifying an additional fee, this Authority did not invite payment of any additional fee.
3.	<input type="checkbox"/> As only some of the required additional search fees were timely paid by the applicant, this international search report covers only those claims for which fees were paid, specifically claims Nos.:
4.	<input type="checkbox"/> No required additional search fees were timely paid by the applicant. Consequently, this international search report is restricted to the invention first mentioned in the claims; it is covered by claims Nos.:
<b>Remark on Protest</b>	
	<input type="checkbox"/> The additional search fees were accompanied by the applicant's protest.
	<input type="checkbox"/> No protest accompanied the payment of additional search fees.

**INTERNATIONAL SEARCH REPORT**  
Information on patent family memt

International application No.  
**PCT/AU 95/00098**

This Annex lists the known "A" publication level patent family members relating to the patent documents cited in the above-mentioned international search report. The Australian Patent Office is in no way liable for these particulars which are merely given for the purpose of information.

Patent Document Cited in Search Report		Patent Family Member					
US	5228074						
US	5020093	CA	2016333	CA	2019000	JP	3035626
		JP	3035628	US	5008925	CA	2022278
		JP	3147402	US	5109536		
US	4989230	CA	1292041	GB	2225512	JP	3001621
		US	5127042	US	5367558		
US	4718080						
WO	9216077	EP	574455				
<b>END OF ANNEX</b>							

**INTERNATIONAL SEARCH REPORT**

International application No.  
PCT/AU 95/00098

C(Continuation). DOCUMENTS CONSIDERED TO BE RELEVANT		
Category*	Citation of document, with indication, where appropriate of the relevant passages	Relevant to Claim No.
X	US 5020093 A (PIREH) 28 May 1991 Column 1 lines 9/12, 52/56 Column 2 lines 24/34 Column 3 lines 36/61	1-11, 13-15
X	US 4989230 A (GILLIG et al) 29 January 1991 Column 1 lines 31/38 Column 2 lines 41/43	1-6, 8-11, 13-15
X	US 4718080 A (SERRANO et al) 5 January 1988 Column 2 lines 17/22, 64/66 Column 3 lines 31/64	1-11, 13-15
X	WO 92/16077 A1 (MOTOROLA INC) 17 September 1992 Page 2 lines 2/16, 29/32 Page 3 lines 21/23 Page 5 lines 3/6 Page 7 lines 4/9	1-6, 8-11, 13-15