



US00RE49721E

(19) **United States**  
(12) **Reissued Patent**  
**Adams et al.**

(10) **Patent Number: US RE49,721 E**  
(45) **Date of Reissued Patent: \*Nov. 7, 2023**

(54) **SYSTEM AND METHOD FOR HANDLING DATA TRANSFERS**

(71) Applicant: **BlackBerry Limited**, Waterloo (CA)

(72) Inventors: **Neil Patrick Adams**, Waterloo (CA);  
**Herbert Anthony Little**, Waterloo (CA); **Michael Grant Kirkup**, Waterloo (CA)

(73) Assignee: **BlackBerry Limited**, Waterloo (CA)

(\* ) Notice: This patent is subject to a terminal disclaimer.

(21) Appl. No.: **17/376,006**

(22) Filed: **Jul. 14, 2021**

**Related U.S. Patent Documents**

Reissue of:

(64) Patent No.: **8,005,469**  
Issued: **Aug. 23, 2011**  
Appl. No.: **12/795,252**  
Filed: **Jun. 7, 2010**

U.S. Applications:

(63) Continuation of application No. 15/177,759, filed on Jun. 9, 2016, now Pat. No. Re. 48,679, which is a (Continued)

(51) **Int. Cl.**  
**H04L 9/40** (2022.01)  
**H04W 12/37** (2021.01)  
(Continued)

(52) **U.S. Cl.**  
CPC ..... **H04L 63/04** (2013.01); **H04L 51/214** (2022.05); **H04L 63/105** (2013.01);  
(Continued)

(58) **Field of Classification Search**  
CPC ..... G06F 21/10; G06F 21/62; G06F 21/6209; G06F 21/6218; G06F 2221/2107; G06F 21/121

(Continued)

(56) **References Cited**

**U.S. PATENT DOCUMENTS**

4,815,128 A 3/1989 Malek  
4,837,812 A 6/1989 Takahashi et al.  
(Continued)

**FOREIGN PATENT DOCUMENTS**

CA 2505343 6/2010  
CN 1831833 9/2006  
(Continued)

**OTHER PUBLICATIONS**

Extended European Search Report issued in European Application No. 21150115.0 May 25, 2021, 7 pages.  
(Continued)

*Primary Examiner* — Minh Dieu Nguyen

(74) *Attorney, Agent, or Firm* — Fish & Richardson P.C.

(57) **ABSTRACT**

Systems and methods for managing data transfers between a secure location and a less secure location. A data transfer checker operating on a mobile device determines whether an attempted data transfer between two locations is permitted. If it is not permitted, then the data transfer is prevented and the user may be notified of the data transfer prevention.

**20 Claims, 11 Drawing Sheets**

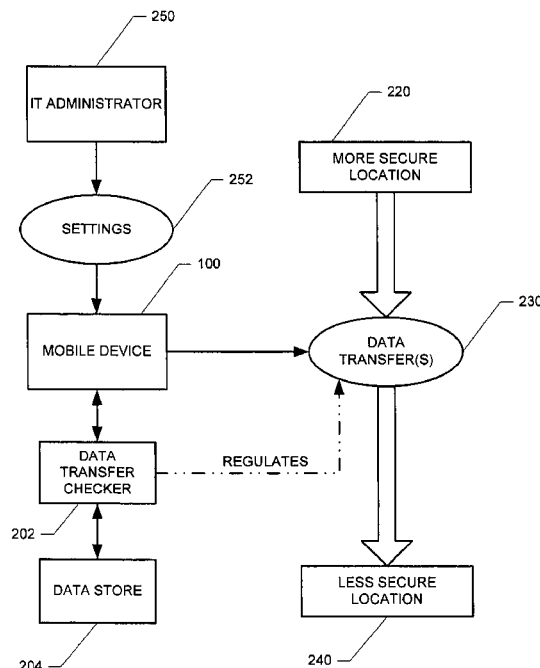

**Related U.S. Application Data**

- continuation of application No. 14/163,416, filed on Jan. 24, 2014, now Pat. No. Re. 46,083, which is a continuation of application No. 13/490,956, filed on Jun. 7, 2012, now Pat. No. Re. 44,746, which is an application for the reissue of Pat. No. 8,005,469, which is a continuation of application No. 11/118,791, filed on Apr. 29, 2005, now Pat. No. 7,734,284.
- (60) Provisional application No. 60/567,293, filed on Apr. 30, 2004.
- (51) **Int. Cl.**  
*H04W 12/033* (2021.01)  
*H04W 12/30* (2021.01)  
*H04L 51/214* (2022.01)  
*H04M 7/00* (2006.01)  
*H04W 12/02* (2009.01)  
*H04W 12/08* (2021.01)  
*H04W 12/63* (2021.01)  
*H04L 51/58* (2022.01)  
*H04M 3/20* (2006.01)
- (52) **U.S. Cl.**  
 CPC ..... *H04M 7/0078* (2013.01); *H04W 12/02* (2013.01); *H04W 12/033* (2021.01); *H04W 12/08* (2013.01); *H04W 12/30* (2021.01); *H04W 12/37* (2021.01); *H04L 51/58* (2022.05); *H04M 3/205* (2013.01); *H04M 2203/609* (2013.01); *H04W 12/63* (2021.01)
- (58) **Field of Classification Search**  
 USPC ..... 726/33; 713/165; 715/770  
 See application file for complete search history.

(56) **References Cited**

U.S. PATENT DOCUMENTS

4,945,556 A 7/1990 Namekawa  
 4,972,457 A 11/1990 O'Sullivan  
 4,991,197 A 2/1991 Morris  
 5,220,604 A 6/1993 Gasser et al.  
 5,408,520 A 4/1995 Clark et al.  
 5,606,594 A 2/1997 Register et al.  
 5,774,551 A 6/1998 Wu et al.  
 5,802,483 A 9/1998 Morris  
 5,826,265 A 10/1998 Van Huben et al.  
 5,850,515 A 12/1998 Lo et al.  
 5,864,683 A 1/1999 Boebert et al.  
 5,864,765 A 1/1999 Barvesten  
 5,933,412 A 8/1999 Choudhury et al.  
 5,987,440 A 11/1999 O'Neil et al.  
 5,987,611 A 11/1999 Freund  
 6,052,735 A 4/2000 Ulrich et al.  
 6,088,693 A 7/2000 Van Huben et al.  
 6,105,132 A 8/2000 Fritch et al.  
 6,125,447 A 9/2000 Gong  
 6,131,136 A 10/2000 Liebenow et al.  
 6,219,694 B1 4/2001 Lazaridis et al.  
 6,233,446 B1 5/2001 Do  
 6,243,756 B1 6/2001 Whitmire et al.  
 6,253,326 B1 6/2001 Lincke et al.  
 6,285,889 B1 9/2001 Nykanen et al.  
 6,292,798 B1 9/2001 Dockter et al.  
 6,343,313 B1 1/2002 Salesky et al.  
 6,351,816 B1 2/2002 Mueller et al.  
 6,360,322 B1 3/2002 Grawrock  
 6,405,202 B1 6/2002 Britton et al.  
 6,408,336 B1 6/2002 Schneider et al.  
 6,412,070 B1 6/2002 Van Dyke et al.  
 6,490,289 B1 12/2002 Zhang et al.  
 6,505,200 B1 1/2003 Ims et al.  
 6,516,421 B1 2/2003 Peters

6,539,385 B1 3/2003 Pollack et al.  
 6,546,554 B1 4/2003 Schmidt et al.  
 6,629,246 B1 9/2003 Gadi  
 6,647,388 B2 11/2003 Numao et al.  
 6,668,323 B1 12/2003 Challener et al.  
 6,745,047 B1 6/2004 Karstens et al.  
 6,748,543 B1 6/2004 Villhuber  
 6,757,821 B1 6/2004 Akiyama et al.  
 6,772,350 B1 8/2004 Belani et al.  
 6,775,536 B1 8/2004 Geiger et al.  
 6,785,810 B1 8/2004 Lirov et al.  
 6,795,688 B1 9/2004 Plasson et al.  
 6,795,967 B1 9/2004 Evans et al.  
 6,799,208 B1 9/2004 Sankaranarayan et al.  
 6,832,256 B1 12/2004 Toga  
 6,886,038 B1 4/2005 Tabbara et al.  
 6,895,502 B1 5/2005 Fraser et al.  
 6,901,429 B2 5/2005 Dowling  
 6,944,677 B1 9/2005 Zhao  
 6,957,330 B1 10/2005 Hughes  
 6,976,241 B2 12/2005 Cruz et al.  
 6,978,385 B1 12/2005 Cheston et al.  
 6,999,562 B2 2/2006 Winick  
 7,042,988 B2 5/2006 Juitt et al.  
 7,076,239 B2 7/2006 Kirkup et al.  
 7,076,797 B2 7/2006 Loveland  
 7,146,638 B2 12/2006 Malcolm  
 7,185,192 B1 2/2007 Kahn  
 7,187,678 B2 3/2007 Cunetto et al.  
 7,233,786 B1 6/2007 Harris et al.  
 7,246,374 B1 7/2007 Simon et al.  
 7,315,750 B2 1/2008 Chou et al.  
 7,317,699 B2 1/2008 Godfrey et al.  
 7,330,712 B2 2/2008 Kirkup et al.  
 7,331,058 B1 2/2008 Gladney  
 7,353,533 B2 4/2008 Wright et al.  
 7,400,878 B2 7/2008 Hassan et al.  
 7,437,362 B1 10/2008 Ben-Natan  
 7,469,417 B2 12/2008 Fearnley et al.  
 7,496,954 B1 2/2009 Himawan et al.  
 7,515,717 B2 4/2009 Doyle et al.  
 7,526,800 B2 4/2009 Wright et al.  
 7,574,200 B2 8/2009 Hassan et al.  
 7,603,466 B2 10/2009 Kilian-Kehr et al.  
 7,620,391 B2 11/2009 Itzkovitz  
 7,689,653 B2 3/2010 Cohen et al.  
 7,721,087 B1 5/2010 DiPasquo et al.  
 7,734,284 B2 6/2010 Adams et al.  
 7,751,331 B1 7/2010 Blair et al.  
 7,765,185 B2 7/2010 Rangadass  
 7,793,355 B2 9/2010 Little et al.  
 7,869,789 B2 1/2011 Hassan et al.  
 7,886,053 B1 2/2011 Newstadt et al.  
 7,890,627 B1 2/2011 Thomas  
 7,917,963 B2 3/2011 Goyal et al.  
 7,921,452 B2 4/2011 Ridlon et al.  
 7,950,066 B1 5/2011 Zuili  
 8,005,469 B2 8/2011 Adams et al.  
 8,041,346 B2 10/2011 Tyhurst et al.  
 8,060,936 B2 11/2011 Mahaffey et al.  
 8,074,078 B2 12/2011 Brown et al.  
 8,087,067 B2 12/2011 Mahaffey et al.  
 8,108,933 B2 1/2012 Mahaffey  
 8,121,638 B2 2/2012 Gisby  
 8,122,362 B2 2/2012 Brush et al.  
 8,145,493 B2 3/2012 Cross, Jr. et al.  
 8,180,893 B1 5/2012 Spertus  
 8,187,100 B1 5/2012 Kahn et al.  
 8,208,900 B2 6/2012 Adler et al.  
 8,344,135 B2 1/2013 Hirose et al.  
 8,347,386 B2 1/2013 Mahaffey et al.  
 8,407,463 B2 3/2013 Ghirardi  
 8,495,700 B2 7/2013 Shahbazi  
 8,495,731 B1 7/2013 Mar et al.  
 8,503,340 B1 8/2013 Xu  
 8,516,095 B2 8/2013 Eisener et al.  
 8,533,844 B2 9/2013 Mahaffey et al.  
 8,584,199 B1 11/2013 Chen et al.  
 8,588,749 B1 11/2013 Sadhvani et al.

(56)

## References Cited

## U.S. PATENT DOCUMENTS

|              |     |         |                   |              |     |         |                    |
|--------------|-----|---------|-------------------|--------------|-----|---------|--------------------|
| 8,626,867    | B2  | 1/2014  | Boudreau          | 2005/0154935 | A1  | 7/2005  | Jin                |
| 8,656,016    | B1  | 2/2014  | Bender et al.     | 2005/0164687 | A1* | 7/2005  | DiFazio            |
| 8,667,482    | B2  | 3/2014  | Bernardi          | 2005/0172040 | A1  | 8/2005  | Hashimoto          |
| 8,799,227    | B2  | 8/2014  | Ferguson et al.   | 2005/0182966 | A1  | 8/2005  | Pham et al.        |
| 8,799,644    | B2  | 8/2014  | Kaleedhass        | 2005/0192008 | A1  | 9/2005  | Desai et al.       |
| 8,856,349    | B2  | 10/2014 | Jain et al.       | 2005/0210270 | A1  | 9/2005  | Rohatgi et al.     |
| 8,869,235    | B2  | 10/2014 | Qureshi et al.    | 2005/0213763 | A1  | 9/2005  | Owen et al.        |
| 8,909,915    | B2  | 12/2014 | Ferren            | 2005/0245272 | A1* | 11/2005 | Spaur et al.       |
| 8,931,042    | B1  | 1/2015  | Weiss             | 2005/0246716 | A1  | 11/2005 | Smith et al.       |
| 9,027,151    | B2  | 5/2015  | Walsh             | 2005/0249209 | A1  | 11/2005 | Fotta              |
| 9,075,967    | B2  | 7/2015  | Marshall          | 2006/0015621 | A1  | 1/2006  | Quinn              |
| 9,111,105    | B2  | 8/2015  | Barton et al.     | 2006/0059556 | A1  | 3/2006  | Royer              |
| 9,183,534    | B2  | 11/2015 | Gharabally        | 2006/0070114 | A1  | 3/2006  | Wood et al.        |
| 9,213,850    | B2  | 12/2015 | Barton et al.     | 2006/0090136 | A1  | 4/2006  | Miller et al.      |
| 9,256,758    | B2  | 2/2016  | Draluk et al.     | 2006/0094400 | A1  | 5/2006  | Beachem            |
| 9,438,550    | B2  | 9/2016  | Fiatal et al.     | 2006/0114832 | A1  | 6/2006  | Hamilton et al.    |
| 9,582,139    | B1  | 2/2017  | Tseng             | 2006/0120526 | A1  | 6/2006  | Boucher et al.     |
| 9,613,219    | B2  | 4/2017  | Ferguson et al.   | 2006/0123485 | A1  | 6/2006  | Williams           |
| 9,684,785    | B2  | 6/2017  | Walsh             | 2006/0129848 | A1* | 6/2006  | Paksoy et al.      |
| 10,461,937   | B1  | 10/2019 | Allen             | 2006/0129948 | A1  | 6/2006  | Hamzy et al.       |
| 10,735,964   | B2  | 8/2020  | Bender et al.     | 2006/0136570 | A1  | 6/2006  | Pandya             |
| 10,848,520   | B2  | 11/2020 | Ferguson et al.   | 2006/0149846 | A1  | 7/2006  | Schuba             |
| 11,032,283   | B2  | 6/2021  | Ryerson et al.    | 2006/0156026 | A1  | 7/2006  | Utin               |
| 2001/0047485 | A1  | 11/2001 | Brown et al.      | 2006/0168259 | A1  | 7/2006  | Spilotro et al.    |
| 2001/0054157 | A1  | 12/2001 | Fukumoto          | 2006/0168395 | A1  | 7/2006  | Deng et al.        |
| 2001/0056549 | A1  | 12/2001 | Pinault et al.    | 2006/0206931 | A1  | 9/2006  | Dillaway et al.    |
| 2002/0013815 | A1  | 1/2002  | Obradovich et al. | 2006/0212589 | A1  | 9/2006  | Hayer et al.       |
| 2002/0019944 | A1  | 2/2002  | Kou               | 2006/0242685 | A1  | 10/2006 | Heard et al.       |
| 2002/0029280 | A1  | 3/2002  | Holden et al.     | 2006/0274750 | A1  | 12/2006 | Babbar et al.      |
| 2002/0031230 | A1  | 3/2002  | Yu et al.         | 2007/0019643 | A1  | 1/2007  | Sahheen            |
| 2002/0035607 | A1  | 3/2002  | Checkoway et al.  | 2007/0050854 | A1  | 3/2007  | Cooperstein et al. |
| 2002/0065946 | A1  | 5/2002  | Narayan           | 2007/0073694 | A1  | 3/2007  | Picault et al.     |
| 2002/0087880 | A1  | 7/2002  | Rhoades           | 2007/0121540 | A1  | 5/2007  | Sharp et al.       |
| 2002/0095414 | A1  | 7/2002  | Barnett et al.    | 2007/0143851 | A1  | 6/2007  | Nicodemus          |
| 2002/0095497 | A1  | 7/2002  | Satagopan et al.  | 2007/0150730 | A1  | 6/2007  | Conti              |
| 2002/0095571 | A1  | 7/2002  | Bradee            | 2007/0156766 | A1  | 7/2007  | Hoang et al.       |
| 2002/0112155 | A1  | 8/2002  | Martherus et al.  | 2007/0162749 | A1  | 7/2007  | Lim                |
| 2002/0184398 | A1  | 12/2002 | Orenshteyn        | 2007/0204153 | A1  | 8/2007  | Tome et al.        |
| 2003/0005317 | A1  | 1/2003  | Audebert et al.   | 2007/0204166 | A1  | 8/2007  | Tome et al.        |
| 2003/0014521 | A1  | 1/2003  | Elson et al.      | 2007/0234359 | A1  | 10/2007 | Bemabeu et al.     |
| 2003/0026220 | A1  | 2/2003  | Uhlík et al.      | 2007/0254631 | A1  | 11/2007 | Spooner            |
| 2003/0031184 | A1  | 2/2003  | Cunetto et al.    | 2007/0277127 | A1  | 11/2007 | Carlson et al.     |
| 2003/0035397 | A1  | 2/2003  | Haller et al.     | 2007/0294253 | A1  | 12/2007 | Strub et al.       |
| 2003/0054860 | A1  | 3/2003  | Chen              | 2008/0002726 | A1  | 1/2008  | Haug et al.        |
| 2003/0061087 | A1  | 3/2003  | Srimuang          | 2008/0028442 | A1  | 1/2008  | Kaza et al.        |
| 2003/0065676 | A1  | 4/2003  | Gbadegesin et al. | 2008/0031235 | A1  | 2/2008  | Harris et al.      |
| 2003/0070091 | A1  | 4/2003  | Loveland          | 2008/0034418 | A1  | 2/2008  | Venkatraman et al. |
| 2003/0084144 | A1  | 5/2003  | Lipinski          | 2008/0034419 | A1  | 2/2008  | Mullick et al.     |
| 2003/0087629 | A1  | 5/2003  | Juitt et al.      | 2008/0056151 | A1  | 3/2008  | Gazier et al.      |
| 2003/0093698 | A1  | 5/2003  | Challener et al.  | 2008/0081609 | A1  | 4/2008  | Burgan et al.      |
| 2003/0120948 | A1  | 6/2003  | Schmidt et al.    | 2008/0098237 | A1  | 4/2008  | Dung et al.        |
| 2003/0126437 | A1  | 7/2003  | Wheeler et al.    | 2008/0109876 | A1  | 5/2008  | Hitomi et al.      |
| 2003/0163685 | A1  | 8/2003  | Paatero           | 2008/0109908 | A1  | 5/2008  | Havens et al.      |
| 2003/0167405 | A1  | 9/2003  | Freund et al.     | 2008/0125146 | A1  | 5/2008  | Bainbridge         |
| 2003/0177389 | A1  | 9/2003  | Albert et al.     | 2008/0130524 | A1  | 6/2008  | Volach et al.      |
| 2003/0200459 | A1  | 10/2003 | Seeman            | 2008/0132202 | A1  | 6/2008  | Kirkup et al.      |
| 2003/0212895 | A1  | 11/2003 | Kisliakov         | 2008/0134347 | A1  | 6/2008  | Goyal et al.       |
| 2003/0226015 | A1  | 12/2003 | Neufeld et al.    | 2008/0137593 | A1  | 6/2008  | Laudermilch et al. |
| 2003/0233410 | A1  | 12/2003 | Gusler            | 2008/0141136 | A1  | 6/2008  | Ozzie et al.       |
| 2003/0236983 | A1  | 12/2003 | Mihm, Jr.         | 2008/0148230 | A1  | 6/2008  | Kemmler            |
| 2004/0001101 | A1  | 1/2004  | Trajkovic et al.  | 2008/0184336 | A1  | 7/2008  | Sarukki et al.     |
| 2004/0083315 | A1  | 4/2004  | Grassian et al.   | 2008/0194336 | A1  | 8/2008  | Gagner et al.      |
| 2004/0083382 | A1* | 4/2004  | Markham et al.    | 2008/0222694 | A1  | 9/2008  | Nakae              |
| 2004/0097217 | A1  | 5/2004  | McClain           | 2008/0222711 | A1  | 9/2008  | Michaelis          |
| 2004/0100983 | A1* | 5/2004  | Suzuki            | 2008/0235041 | A1  | 9/2008  | Cashdollar et al.  |
| 2004/0121802 | A1  | 6/2004  | Kim et al.        | 2008/0244074 | A1  | 10/2008 | Baccas             |
| 2004/0177073 | A1  | 9/2004  | Snyder et al.     | 2008/0263014 | A1  | 10/2008 | Mazario et al.     |
| 2004/0205342 | A1  | 10/2004 | Roegner           | 2008/0305832 | A1  | 12/2008 | Greenberg          |
| 2004/0209608 | A1* | 10/2004 | Kouznetsov et al. | 2008/0310633 | A1  | 12/2008 | Brown et al.       |
| 2004/0215702 | A1  | 10/2004 | Hamasaki et al.   | 2008/0313648 | A1  | 12/2008 | Wang et al.        |
| 2004/0260710 | A1  | 12/2004 | Marston           | 2008/0318616 | A1  | 12/2008 | Chipalkatti et al. |
| 2004/0268151 | A1  | 12/2004 | Matsuda et al.    | 2009/0031393 | A1  | 1/2009  | Denner             |
| 2005/0022023 | A1  | 1/2005  | Chincheck et al.  | 2009/0037594 | A1  | 2/2009  | Sever              |
| 2005/0039040 | A1  | 2/2005  | Ransom et al.     | 2009/0068996 | A1  | 3/2009  | Bakker et al.      |
| 2005/0149726 | A1  | 7/2005  | Joshi             | 2009/0070181 | A1  | 3/2009  | Loeffen            |
|              |     |         |                   | 2009/0083643 | A1  | 3/2009  | Beringer           |
|              |     |         |                   | 2009/0094668 | A1  | 4/2009  | Corbin et al.      |
|              |     |         |                   | 2009/0178107 | A1  | 7/2009  | Kaijoth et al.     |
|              |     |         |                   | 2009/0181662 | A1  | 7/2009  | Fleischman et al.  |



(56)

## References Cited

## FOREIGN PATENT DOCUMENTS

|    |             |        |
|----|-------------|--------|
| WO | 2007/048251 | 5/2007 |
| WO | 2009/012329 | 1/2009 |
| WO | 2009/014975 | 1/2009 |
| WO | 2009/021200 | 2/2009 |
| WO | 2012/037656 | 3/2012 |
| WO | 2012/037657 | 3/2012 |
| WO | 2012/037658 | 3/2012 |
| WO | 2012/109497 | 8/2012 |

## OTHER PUBLICATIONS

Non-Final Office Action issued in United States U.S. Appl. No. 16/733,375 on Mar. 14, 2022, 24 pages.

Payne et al., "Towards Deep Federated Defenses Against Malware in Cloud Ecosystems" 2019 First IEEE International Conference On Trust, Privacy and Security in Intelligent Systems and Applications (TPS-ISA), Dec. 2019, 9 pages.

Yang et al., "The Tradeoff Between Privacy and Accuracy in Anomaly Detection Using Federated KGBBoost" Jul. 2019, 7 pages. Examination Report issued in Indian Application No. 3486/CHENP/2014, dated Sep. 27, 2021, 7 pages (with English Translation).

"A Technical Overview of the Lucent VPN Firewall," White Paper Lucent Technologies, Aug. 2002, Chapter 1, (XP002271173), 35 pages.

Basic Access Authentication, Jan. 23, 2010, 3 pages; <[http://en.wikipedia.org/wiki/Basic\\_access\\_authentication](http://en.wikipedia.org/wiki/Basic_access_authentication)>.

Boyce, "Microsoft Outlook 2010 Inside Out," Microsoft Press, (XP055196121), Aug. 15, 2010, chapters cited: 3, 6-7, 14, 18-19, 21, 34-35, 152 pages.

Bugiel et al., "Practical and lightweight domain isolation on android," in Proceedings of the 1st ACM workshop on Security and privacy in smartphones and mobile devices, ACM, 2011, 51-62, 12 pages.

Chen, "Java Card Technology for Smart Cards : Architecture and Programmer's Guide: Applet Firewall and Object Sharing.," Jun. 2, 2000, retrieved from : URL <<http://developer.java.sun.com/developer/Books/consumerproducts/javacard/ch09.pdf>>, 23 pages.

Cr.yip.to/docs/secureipc.html [online], "Secure Inter-Process Communication", Apr. 4, 2004, [retrieved on Jan. 20, 2014], retrieved from : URL <<https://web.archive.org/web/20040404015137/http://cr.yip.to/docs/secureipc.html>>, 2 pages.

Google Inc., "Android 2.3.4 User's Guide", May 20, 2011, 384 pages.

Gupta et al., "Using context-profiling to aid access control decisions in mobile devices," Pervasive Computing and Communications Workshops, 2011 IEEE International Conference on, Mar. 21-25, 2011, 3 pages.

IETF RFC 3530, "Network File System (NFS) Version 4 Protocol"; Apr. 2003, 191 pages.

Kelley, "Smartphone Security Beyond Lock and Wipe," Web: Enterprise Mobile Today, Jun. 10, 2010, <<http://www.enterprisemobiletoday.com/article.php/3887006>>; 3 pages.

Korpipaa et al., "Customizing User Interaction in Smart Phones," IEEE Pervasive Computing; vol. 5, No. 3; Aug. 14, 2006, 82-90, 9 pages.

Microsoft Corp. 2010, Microsoft Office: Microsoft Outlook 2010 Product Guide, 2010, 65 pages.

Microsoft Corp., "Microsoft Outlook 2010" Released Jul. 15, 2010, 27 pages.

Provision of the Minutes of Oral Proceedings in Accordance with Rule 124(4) EPC issued in European Application No. 13165229.9 on Apr. 25, 2019, 6 pages.

Red Hat, "Red Hat Linux 7.2: The Official Red Hat Linux Reference Guide," Red Hat Linux Manuals, Oct. 22, 2001, retrieved from: URL <<http://www.uvm.edu/~fcs/Doc/RedHat/rhl-rg-en-72.pdf>>, 145-155, 11 pages.

Research In Motion, "BlackBerry Bridge App 2.1 and Blackberry PlayBook Tablet 2.1, Security Technical Overview"; Version 2.1; Jul. 17, 2012, 43 pages.

Research In Motion, "BlackBerry Device Service 6.1 and BlackBerry PlayBook Tablet 2.1, Security Technical Overview"; Version: 6.1; Sep. 17, 2012, 90 pages.

Saurabh, "Automatically Open Certain Websites in Google Chrome Incognito Private Browsing Mode"; Dec. 31, 2012; 5 pages; <<http://web.archive.org/web/20121231021254/http://www.techgyd.com/auto-open-sites-in-google-incognito/360>>.

Seifert, "Supporting Mobile Privacy and Security through Sensor-Based Context Detection," Second International Workshop on Security and Privacy in Spontaneous Interaction and Mobile Phone Use (IWSSI/SPMU), May 17, 2010, Finland, 2 pages; <<http://www.medien.fifi.lmu.de/iwssi2010/papers/iwssi-spmu2010-seifert.pdf>>.

Support.office.com [online], "Introduction to using IRM for e-mail messages; Support/Outlook/Outlook 2007 Help and How-to" retrieved from : URL <<https://support.office.com/en-US/article/Introduction-to-using-IRM-for-e-mail-messages-8b08a372-08b3-40ea-8aa2-c6129b15819e?CorrelationId=a93a9795-e5c7-454b-b889-0db0778d0926&ocmsassetID=HA010100366>>, 8 pages.

Support.office.com [online], "Send an e-mail message with restricted permission by using IRM; Support/Outlook/Outlook 2007 Help and How to" retrieved from: URL <<https://support.office.com/en-us/article/Send-an-e-mail-message-with-restricted-permission-by-using-IRM-9026A694-889C-4F98-9889-7A96959886C7>>, 5 pages.

Support.office.com [online], "View messages with restricted permission sent by using IRM; Support/Outlook/Outlook 2007 Help and How-to" retrieved from : URL <<https://support.office.com/en-US/article/View-messages-with-restricted-permission-sent-by-using-IRM-97B8F378-8526-4F72-86BE-63AAQF073122>>, 3 pages.

Sygate, "Sygate Personal Firewall PRO User Guide" Sygate Personal Firewall Pro User Guide version 2.0; 2001, pp. 1-77, XP002248366.

Wack et al., "Guidelines on Firewalls and Firewall Policy: Recommendations of the National Institute of Standards and Technology," NIST Special Publication 800-41, Jan. 2002, 81 pages.

Wikipedia.org [online], "Cross-site request forgery" Nov. 30, 2008, retrieved from: URL <[http://en.wikipedia.org/wiki/Cross-site\\_request\\_forgery](http://en.wikipedia.org/wiki/Cross-site_request_forgery)>, 8 pages.

Wikipedia.org [online], "Digest Access Authentication" Dec. 23, 2009, retrieved from: URL <[http://en.wikipedia.org/wiki/Digest\\_access\\_authentication](http://en.wikipedia.org/wiki/Digest_access_authentication)>, 7 pages.

Wikipedia.org [online], "File System Permissions," created on or before Nov. 1, 2011, [retrieved on Jun. 15, 2016], retrieved from : URL <[https://en.wikipedia.org/w/index.php?title=File\\_system\\_permissions&oldid=458457904](https://en.wikipedia.org/w/index.php?title=File_system_permissions&oldid=458457904)>, 6 pages.

Windows 7 Product Guide, Microsoft Corp. 2009, published in 2009, 140 pages.

Yang et al., "EagleVision: A Pervasive Mobile Device Protection System," published in Mobile and Ubiquitous Systems: Networking & Services, IEEE, Jul. 13-16, 2009, 10 pages.

Brazilian Office Action issued in Brazilian Application No. PI0510378-9 on May 7, 2018, 11 pages.

Examination Search Report issued in Canadian Application No. 2,854,540 on Apr. 3, 2019, 15 pages.

Office Action issued in Canadian Application No. 2,854,540 dated May 12, 2020, 1 page.

Office Action issued in Canadian Application No. 2,861,676 dated Jun. 5, 2020, 3 pages.

Office Action issued in Canadian Application No. 2,829,805 dated Jun. 5, 2020, 5 pages.

Office Action issued in Canadian Application No. 2,792,707 dated Sep. 28, 2016, 3 pages.

Office Action issued in Canadian Application No. 2,854,540 dated Aug. 13, 2018, 7 pages.

Brief Communication of Oral Proceedings issued in European Application No. 12173030.3 on Oct. 29, 2018, 5 pages.

Communication Pursuant to Article 94(3) EPC issued in European Application No. 11186802.2 on Mar. 14, 2016, 6 pages.

Communication Pursuant to Article 94(3) EPC issued in European Application No. 11841258.4 on Mar. 21, 2018, 4 pages.

Communication Pursuant to Article 94(3) EPC issued in European Application No. 12173030.3 on Sep. 8, 2016, 4 pages.

Communication Pursuant to Article 94(3) EPC issued in European Application No. 12847536.5 on Mar. 16, 2016, 10 pages.

(56) **References Cited**

## OTHER PUBLICATIONS

- Communication Pursuant to Article 94(3) EPC issued in European Application No. 13165229.9 on Mar. 21, 2018, 6 pages.
- Decision to Refuse a European Application issued in European Application No. 11186802.2 on May 16, 2018, 27 pages.
- Decision to Refuse a European Patent Application issued in European Application No. 11188696.6 on Dec. 14, 2017, 15 pages.
- Decision to refuse a European Patent Application issued in European Application No. 12173030.3 on Dec. 3, 2018, 12 pages.
- Decision to Refuse a European Patent Application issued in European Application No. 12847536.5 on Jul. 11, 2017, 16 pages.
- Decision to Refuse a European Patent issued in European Application No. 13165229.9 on Apr. 29, 2019, 17 pages.
- Extended European Search Report issued in European Application No. 04256690.1, dated Apr. 6, 2005, 9 pages.
- European Supplementary Search Report issued in European Application No. 05738877.9 dated Sep. 13, 2007, 3 pages.
- Extended European Search Report issued in European Application No. 11162178.5, dated Mar. 17, 2014, 7 pages.
- Extended European Search Report issued in European Application No. 11186796.6 dated Jan. 18, 2012, 8 pages.
- Extended European Search Report issued in European Application No. 11186802.2 dated Jan. 18, 2012, 7 pages.
- Extended European Search Report issued in European Application No. 11188696.6, dated Apr. 12, 2012, 7 pages.
- Extended European Search Report issued in European Application No. 12153439.0, dated Jul. 13, 2012, 7 pages.
- Extended European Search Report issued in European Application No. 12155659.1, dated Aug. 1, 2012, 7 pages.
- Extended European Search Report issued in European Application No. 12173030.3 dated Nov. 22, 2012, 6 pages.
- Extended European Search Report issued in European Application No. 12189773.0 dated Mar. 7, 2013, 8 pages.
- Extended European Search Report issued in European Application No. 12189805.0 dated Apr. 16, 2013, 6 pages.
- Extended European Search Report issued in European Application No. 12847536.5, dated Jun. 29, 2015, 8 pages.
- Extended European Search Report issued in European Application No. 11841258.4 dated Apr. 6, 2017, 6 pages.
- Extended European Search Report issued in European Application No. 13165229.9 dated Nov. 10, 2015, 7 pages.
- Result of Consultation issued in European Application No. 13165229.9 on Dec. 10, 2018, 10 pages.
- Summons to Attend Oral Proceedings Pursuant to Rule 115(1) EPC issued in European Application No. 12847536.5 on Dec. 13, 2016, 6 pages.
- Summons to Attend Oral Proceedings Pursuant to Rule 115(1) EPC issued in European Application No. 11188696.6 on Apr. 25, 2017, 4 pages.
- Summons to Attend Oral Proceedings Pursuant to Rule 115(1) EPC issued in European Application No. 11186802.2 on Nov. 23, 2017, 7 pages.
- Summons to Attend Oral Proceedings Pursuant to Rule 115(1) EPC issued in European Application No. 12173030.3 on Aug. 20, 2018, 8 pages.
- Summons to Attend Oral Proceedings Pursuant to Rule 115(1) EPC issued in European issued Application No. 11841258.4 on Aug. 7, 2019, 5 pages.
- Hearing Notice issued in Indian Application No. 6068/DELNP/2006, dated Aug. 3, 2018, 5 pages.
- Office Action issued in Chinese Application No. 201180065344.5 dated Jun. 3, 2016, 7 pages.
- Office Action issued in Chinese Application No. 201280066715.6 dated Feb. 26, 2019, 8 pages.
- Office Action issued in Chinese Application No. 201280066715.6 dated Jul. 2, 2018, 22 pages.
- Office Action issued in Chinese Application No. 201280066715.6 dated Mar. 4, 2016, 26 pages.
- Office Action issued in Chinese Application No. 201280066715.6 dated Mar. 9, 2017, 13 pages.
- Office Action issued in Chinese Application No. 201280066715.6 dated Nov. 10, 2016, 14 pages.
- Office Action issued in Chinese Application No. 201280066715.6 dated Sep. 6, 2017, 15 pages.
- Office Action issued in Chinese Application No. 201280066860.4 dated May 17, 2017, 14 pages.
- Office Action issued in Chinese Application No. 201280066860.4 dated Sep. 18, 2016, 17 pages.
- Office Action issued in Chinese Application No. 201310503089.9 dated Jun. 13, 2017, 14 pages.
- Office Action issued in Chinese Application No. 201310503089.9 dated Mar. 2, 2017, 15 pages.
- Office Action issued in Chinese Application No. 201310503089.9 dated Sep. 28, 2016, 22 pages.
- Office Action issued in Chinese Application No. 201310504548.5 dated Mar. 22, 2017, 18 pages.
- Office Action issued in Chinese Application No. 201310504548.5 dated Sep. 5, 2016, 15 pages.
- Reexamination Decision issued in Chinese Application No. 201280066715.6 on Nov. 27, 2018, 22 pages.
- Reexamination Report issued in Chinese Application No. 201280066715.6 on Aug. 31, 2018, 13 pages.
- Supplementary Search issued in Chinese Application No. 2012800667156 on Feb. 14, 2019, 1 page.
- PCT International Preliminary Report on Patentability under Ch. II in International Application No. PCT/CA2012/050796, dated Mar. 10, 2014; 5 pages.
- PCT International Preliminary Report on Patentability under Chapter II in International Application No. PCT/CA2012/050797, dated Feb. 12, 2014, 7 pages.
- PCT International Search Report and Written Opinion in International Application No. PCT/CA2012/050797, dated Feb. 5, 2013, 8 pages.
- PCT International Search Report and Written Opinion in International Application No. PCT/CA2011/050707, dated Jan. 18, 2012, 7 pages.
- PCT International Search Report and Written Opinion in International Application No. PCT/CA2012/050796, dated Feb. 21, 2013, 13 pages.
- PCT International Search Report in International Application No. PCT/CA2005/000652, dated Aug. 17, 2005, 9 pages.
- Advisory Action issued in U.S. Appl. No. 13/296,963 on Mar. 29, 2019, 3 pages.
- Advisory Action issued in U.S. Appl. No. 13/296,963 on May 15, 2020, 4 pages.
- Advisory Action issued in U.S. Appl. No. 13/801,437 on May 7, 2019, 2 pages.
- Advisory Action issued in U.S. Appl. No. 15/177,759 on Apr. 3, 2020, 3 pages.
- Advisory Action issued in U.S. Appl. No. 15/177,759 on Aug. 14, 2018, 3 pages.
- Advisory Action issued in U.S. Appl. No. 15/180,911 on Apr. 1, 2020, 2 pages.
- Advisory Action issued in U.S. Appl. No. 15/180,911 on Jan. 4, 2019, 3 pages.
- Advisory Action issued in U.S. Appl. No. 15/478,824 on Oct. 12, 2018, 7 pages.
- Advisory Action issued in U.S. Appl. No. 15/478,824 on Oct. 4, 2019, 3 pages.
- Corrected Notice of Allowability issued in U.S. Appl. No. 15/218,776 on Jun. 16, 2020, 3 pages.
- Corrected Notice of Allowability issued in U.S. Appl. No. 15/218,776 on Oct. 16, 2019, 5 pages.
- Final Office Action issued in U.S. Appl. No. 13/296,963 dated Dec. 14, 2018, 17 pages.
- Final Office Action issued in U.S. Appl. No. 13/296,963 dated Feb. 6, 2020, 36 pages.
- Final Office Action issued in U.S. Appl. No. 13/296,963 on Oct. 5, 2017, 28 pages.
- Final Office Action issued in U.S. Appl. No. 13/801,437 dated Feb. 25, 2019, 59 pages.
- Final Office Action issued in U.S. Appl. No. 13/801,437 dated Nov. 28, 2017, 48 pages.

(56)

**References Cited**

## OTHER PUBLICATIONS

Final office action issued in U.S. Appl. No. 15/177,759 dated Jan. 21, 2020, 25 pages.  
 Final Office Action issued in U.S. Appl. No. 15/177,759 dated Jan. 28, 2021, 20 pages.  
 Final Office Action issued in U.S. Appl. No. 15/180,911 dated Dec. 31, 2019, 32 pages.  
 Final Office Action issued in U.S. Appl. No. 15/180,911 dated Oct. 5, 2018, 12 pages.  
 Final Office Action issued in U.S. Appl. No. 15/218,776 dated Sep. 22, 2017, 33 pages.  
 Final Office Action issued in U.S. Appl. No. 15/478,824 dated Jul. 15, 2019, 41 pages.  
 Final Office Action issued in U.S. Appl. No. 15/478,824 dated Jul. 20, 2018, 18 pages.  
 Interview Summary issued in U.S. Appl. No. 15/180,911 dated Sep. 16, 2020, 2 pages.  
 Interview Summary issued in U.S. Appl. No. 15/478,824 dated Oct. 5, 2018, 2 pages.  
 Non-Final Office Action issued in U.S. Appl. No. 15/180,911 dated Jun. 13, 2019, 43 pages.  
 Non-Final Office Action issued in U.S. Appl. No. 13/296,963 dated Jul. 5, 2018, 24 pages.  
 Non-Final Office Action issued in U.S. Appl. No. 13/296,963 dated Jul. 7, 2017, 44 pages.  
 Non-final office action issued in U.S. Appl. No. 13/296,963 dated Oct. 3, 2019, 48 pages.  
 Non-Final Office Action issued in U.S. Appl. No. 13/801,437 dated Aug. 3, 2018, 23 pages.  
 Non-Final Office Action issued in U.S. Appl. No. 15/177,759 dated Sep. 10, 2019, 22 pages.  
 Non-Final Office Action issued in U.S. Appl. No. 15/177,759 dated Sep. 27, 2018, 22 pages.  
 Non-Final Office Action issued in U.S. Appl. No. 15/177,759 dated Sep. 4, 2020, 41 pages.  
 Non-Final Office Action issued in U.S. Appl. No. 15/478,824 dated Jan. 31, 2019, 10 pages.  
 Non-Final office action issued in U.S. Appl. No. 15/478,824 dated Nov. 7, 2019, 16 pages.  
 Non-Final Office Action issued in U.S. Appl. No. 15/177,759 dated May 25, 2018, 21 pages.

Non-Final Office Action issued in U.S. Appl. No. 15/180,911 dated Mar. 21, 2018, 10 pages.  
 Non-Final Office Action issued in U.S. Appl. No. 15/478,824 dated Feb. 7, 2018, 15 pages.  
 Notice of Allowance issued in U.S. Appl. No. 15/177,759 dated Jun. 3, 2019, 66 pages.  
 Notice of Allowance issued in U.S. Appl. No. 15/177,759 dated Mar. 25, 2021, 10 pages.  
 Notice of Allowance issued in U.S. Appl. No. 15/180,911 dated Mar. 9, 2021, 14 pages.  
 Notice of Allowance issued in U.S. Appl. No. 15/180,911 dated Sep. 16, 2020, 43 pages.  
 Notice of allowance issued in U.S. Appl. No. 15/218,776 dated Dec. 18, 2019, 11 pages.  
 Notice of Allowance issued in U.S. Appl. No. 15/218,776 dated Feb. 21, 2019, 14 pages.  
 Notice of Allowance issued in U.S. Appl. No. 15/218,776 dated Jan. 10, 2019, 8 pages.  
 Notice of Allowance issued in U.S. Appl. No. 15/218,776 dated Jun. 21, 2018, 8 pages.  
 Notice of Allowance issued in U.S. Appl. No. 15/218,776 dated May 30, 2019, 14 pages.  
 Notice of allowance issued in U.S. Appl. No. 15/218,776 dated Nov. 4, 2019, 11 pages.  
 Notice of Allowance issued in U.S. Appl. No. 15/478,824 dated Apr. 15, 2020, 21 pages.  
 Notice of Allowance issued in U.S. Appl. No. 15/478,824 dated Aug. 31, 2020, 12 pages.  
 Notice of Allowance issued in U.S. Appl. No. 15/478,824 dated Nov. 27, 2018, 9 pages.  
 Notice of Allowance issued in U.S. Appl. No. 16/733,375 dated Sep. 6, 2022, 10 pages.  
 Notice of Allowance in U.S. Appl. No. 16/734,103, dated Nov. 10, 2022, 8 pages.  
 Hearing Notice in Indian Appln. No. 3486/CHENP/2014, dated Mar. 29, 2023, 3 pages (with English translation).  
 International Search Report of Application No. PCT/CA2005/000652, date of mailing Aug. 17, 2005.  
 Japanese Notice of Reasons for Rejection mailed on Jun. 15, 2009 for Japanese Patent Application No. 2007-509840.  
 Singh, Anish, Australian Patent Office, Australian Application No. 20090202857, filed Apr. 29, 2005, in Examiner's First Report, mailed Nov. 5, 2010, 3 pages.

\* cited by examiner

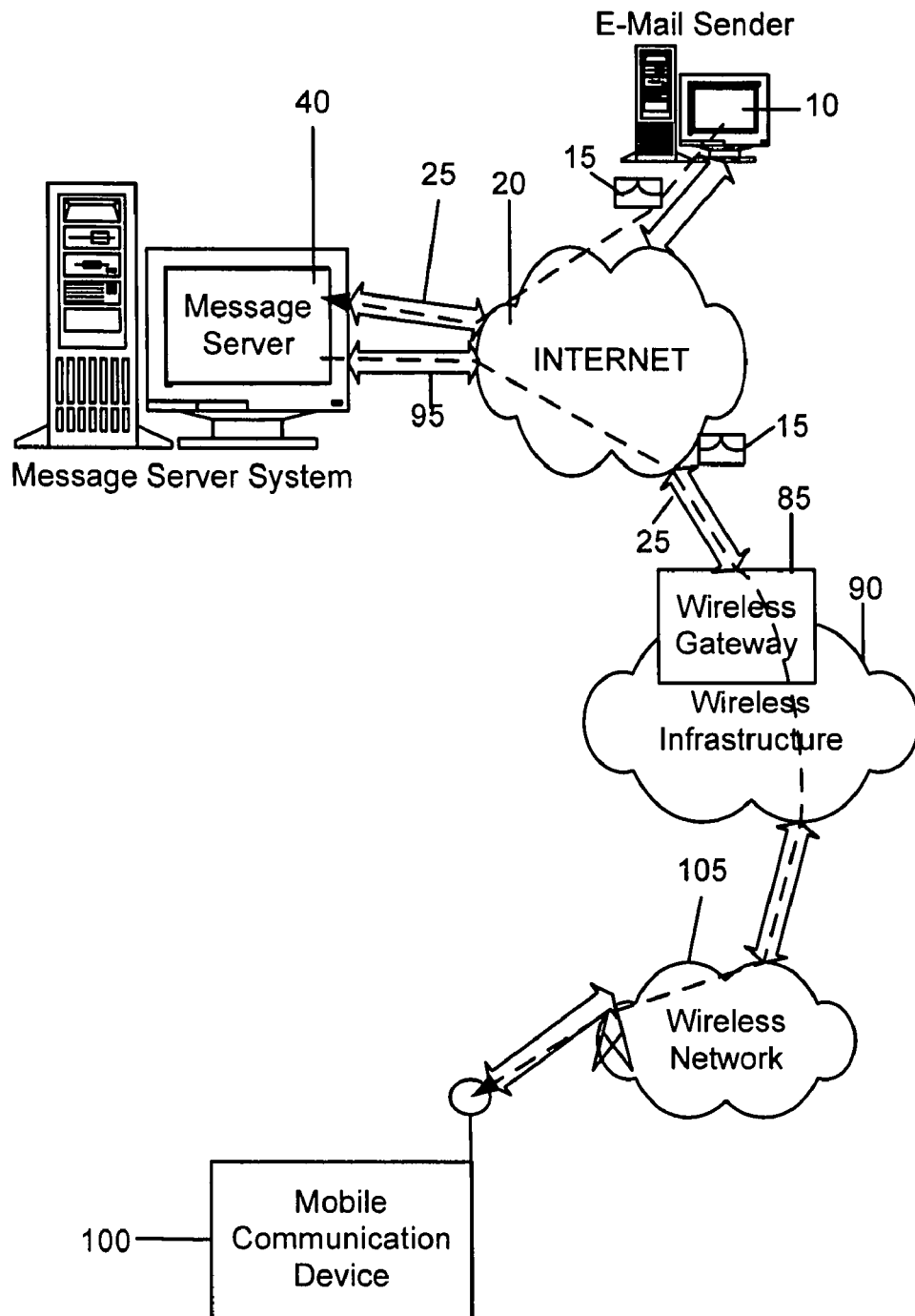

**FIG. 1**

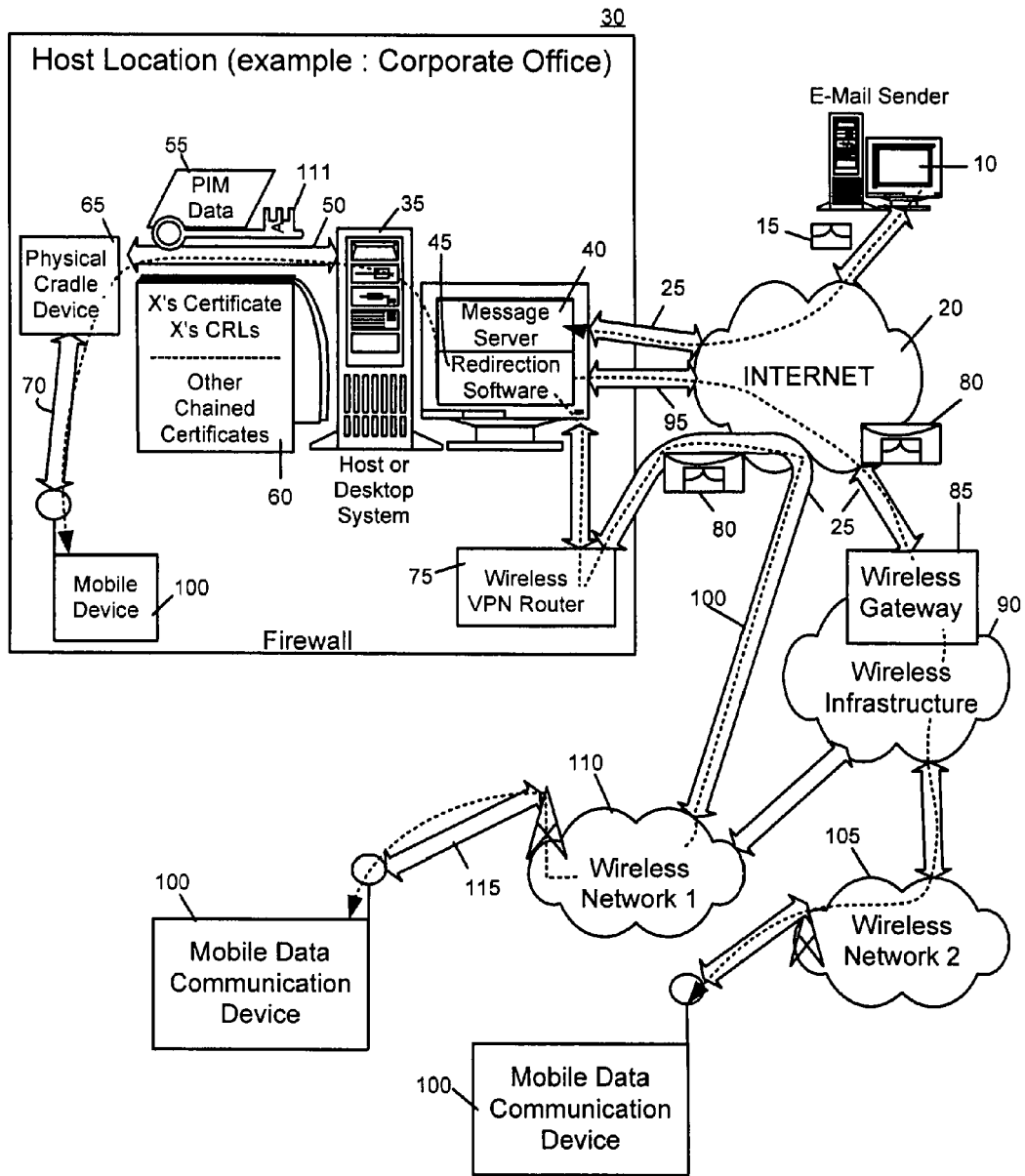

**FIG. 2**

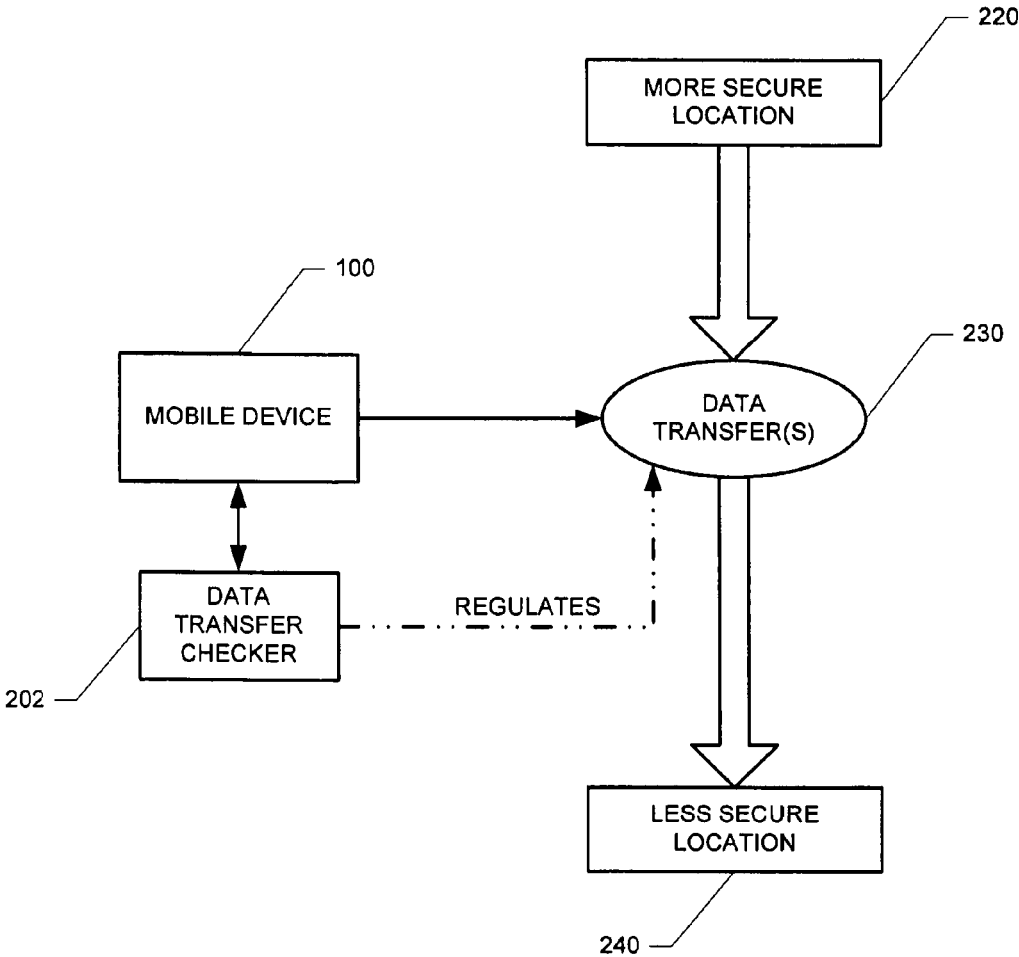

**FIG. 3**

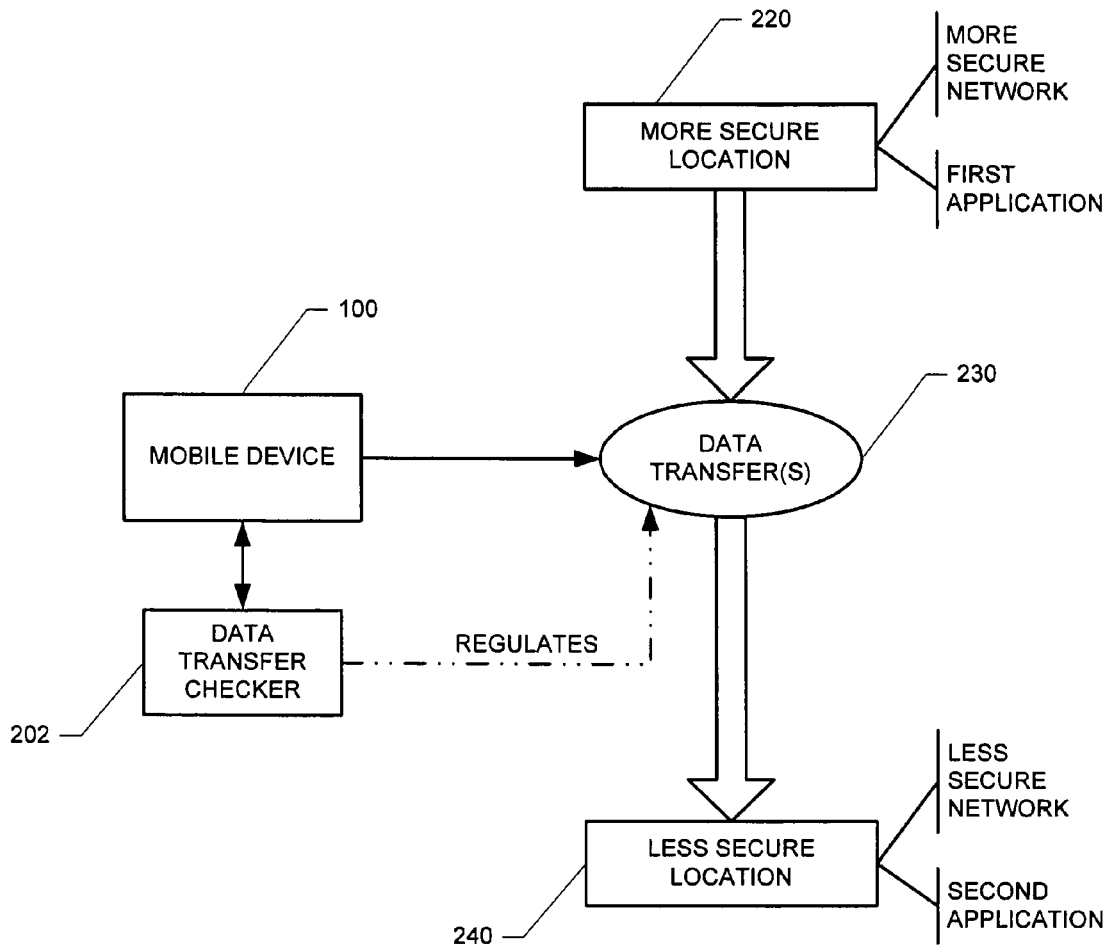

**FIG. 4**

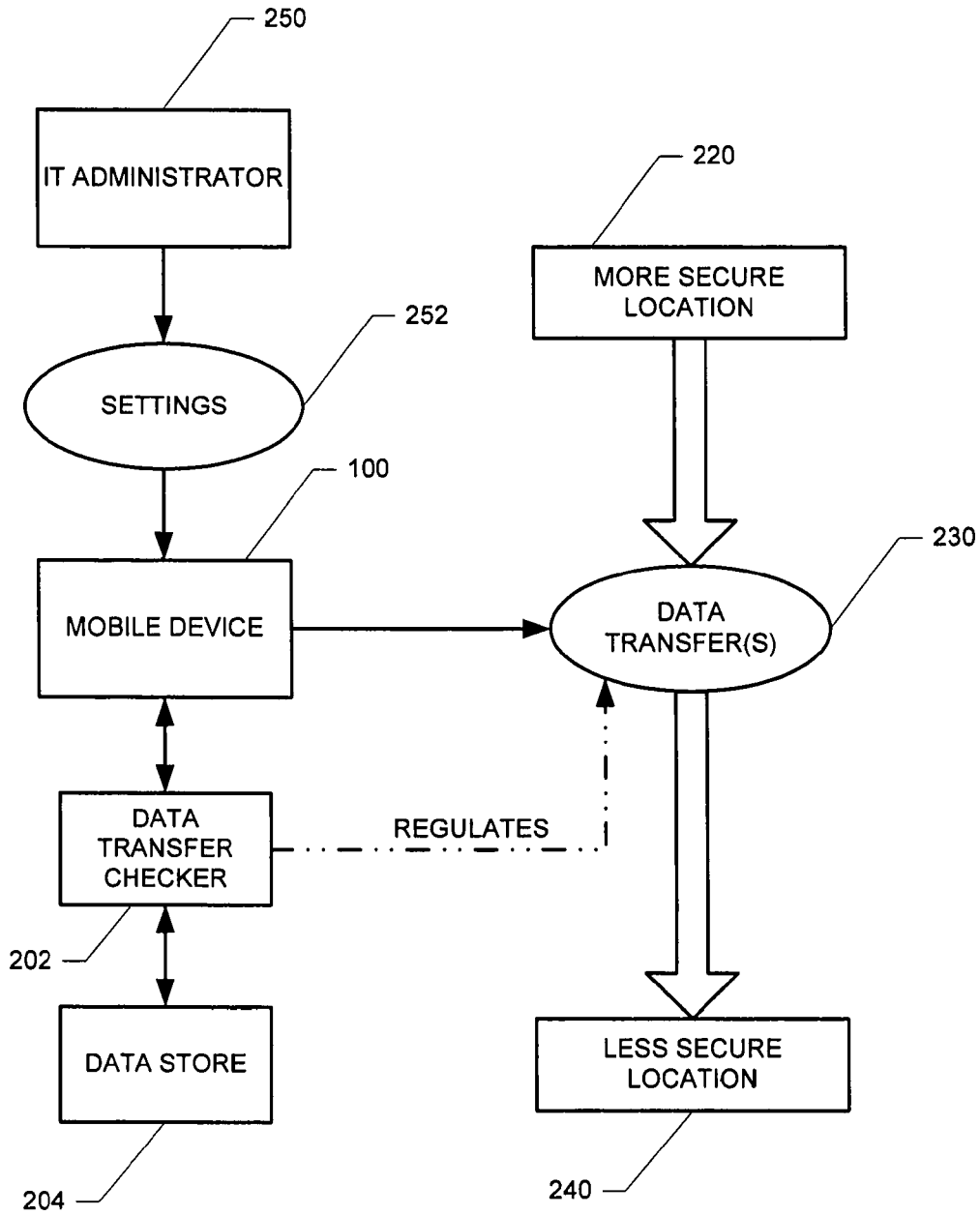

**FIG. 5**

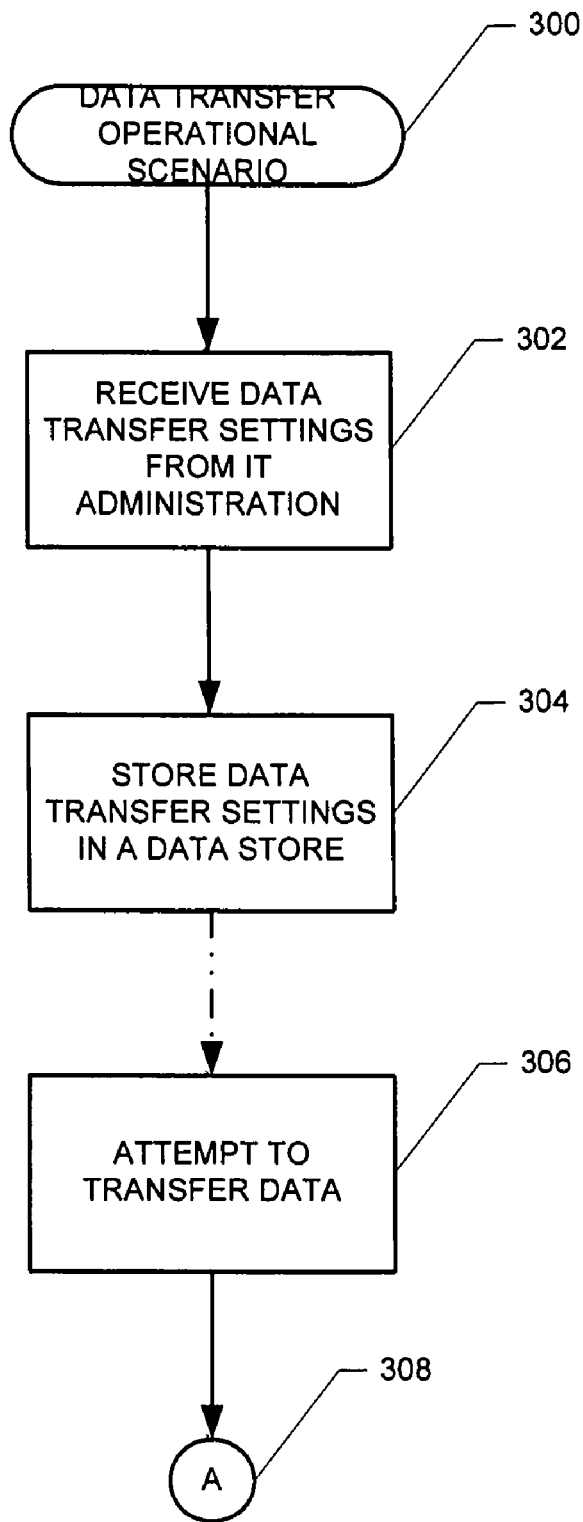

**FIG. 6**

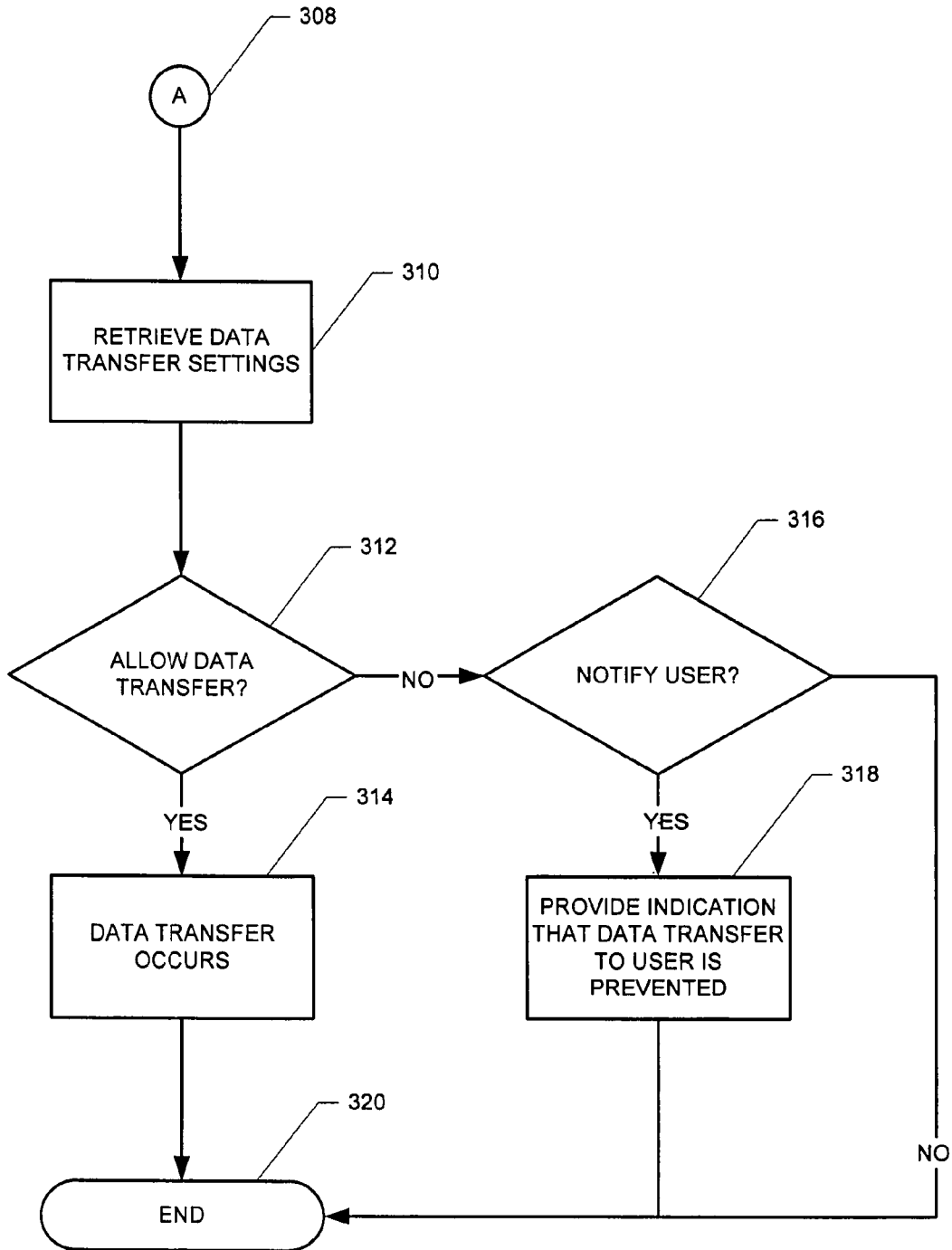

**FIG. 7**

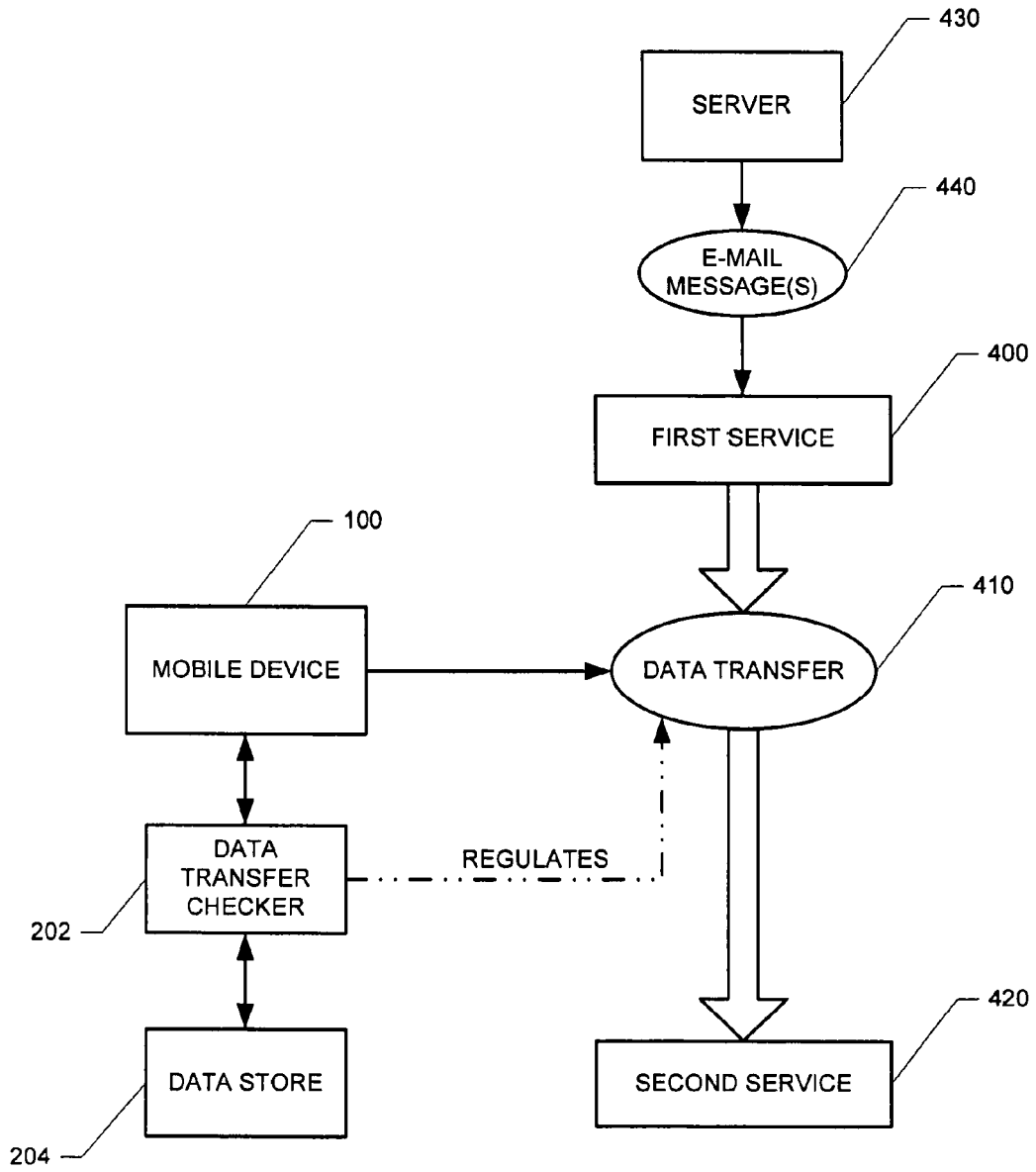

**FIG. 8**

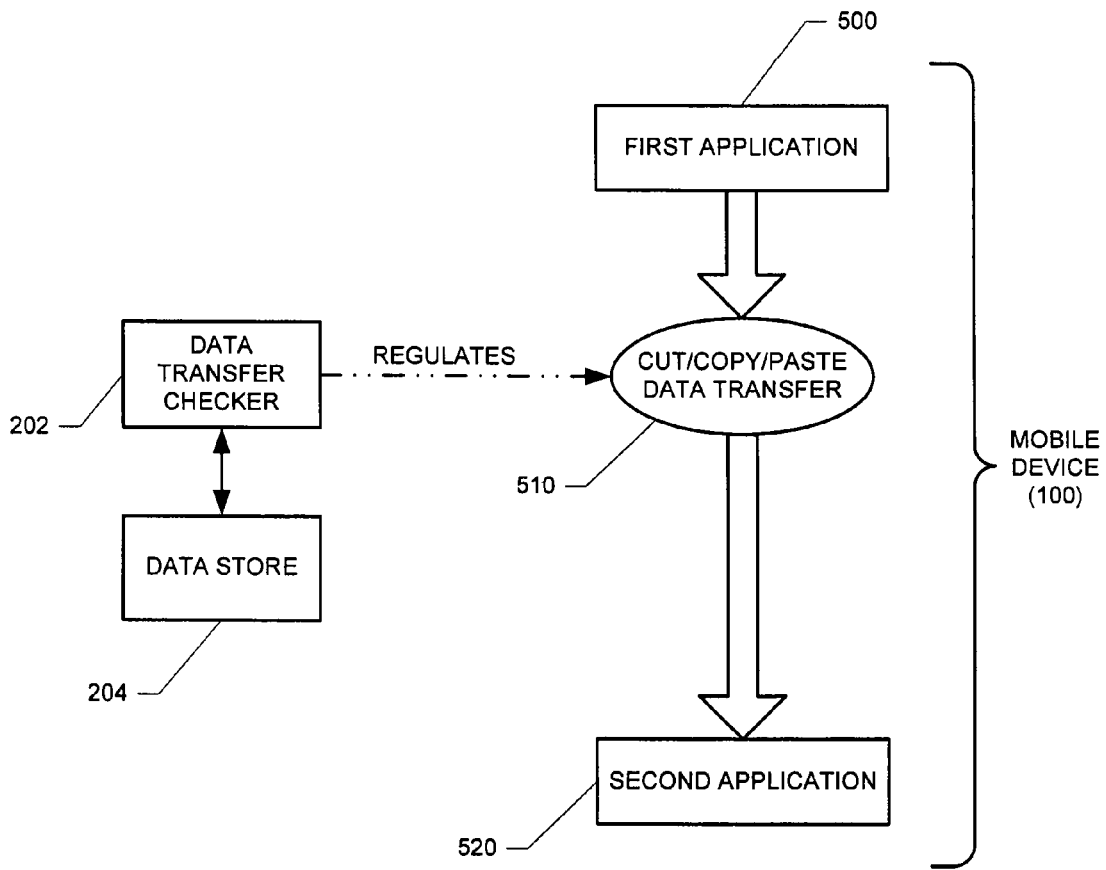

**FIG. 9**

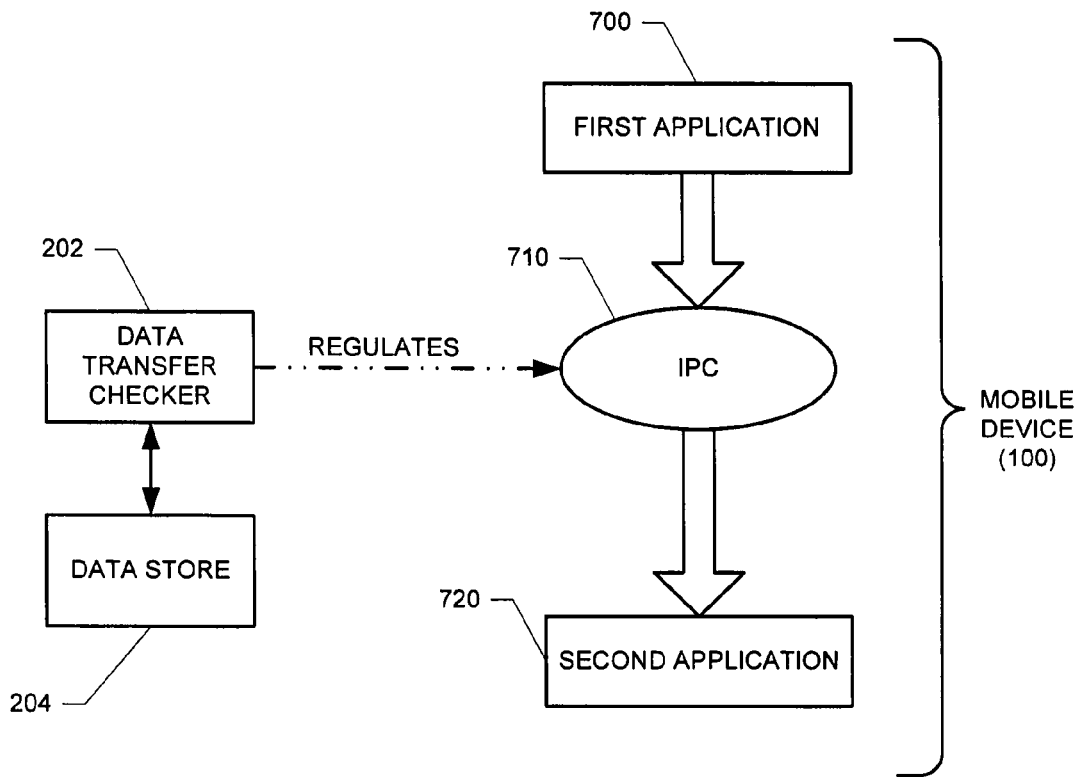

**FIG. 10**

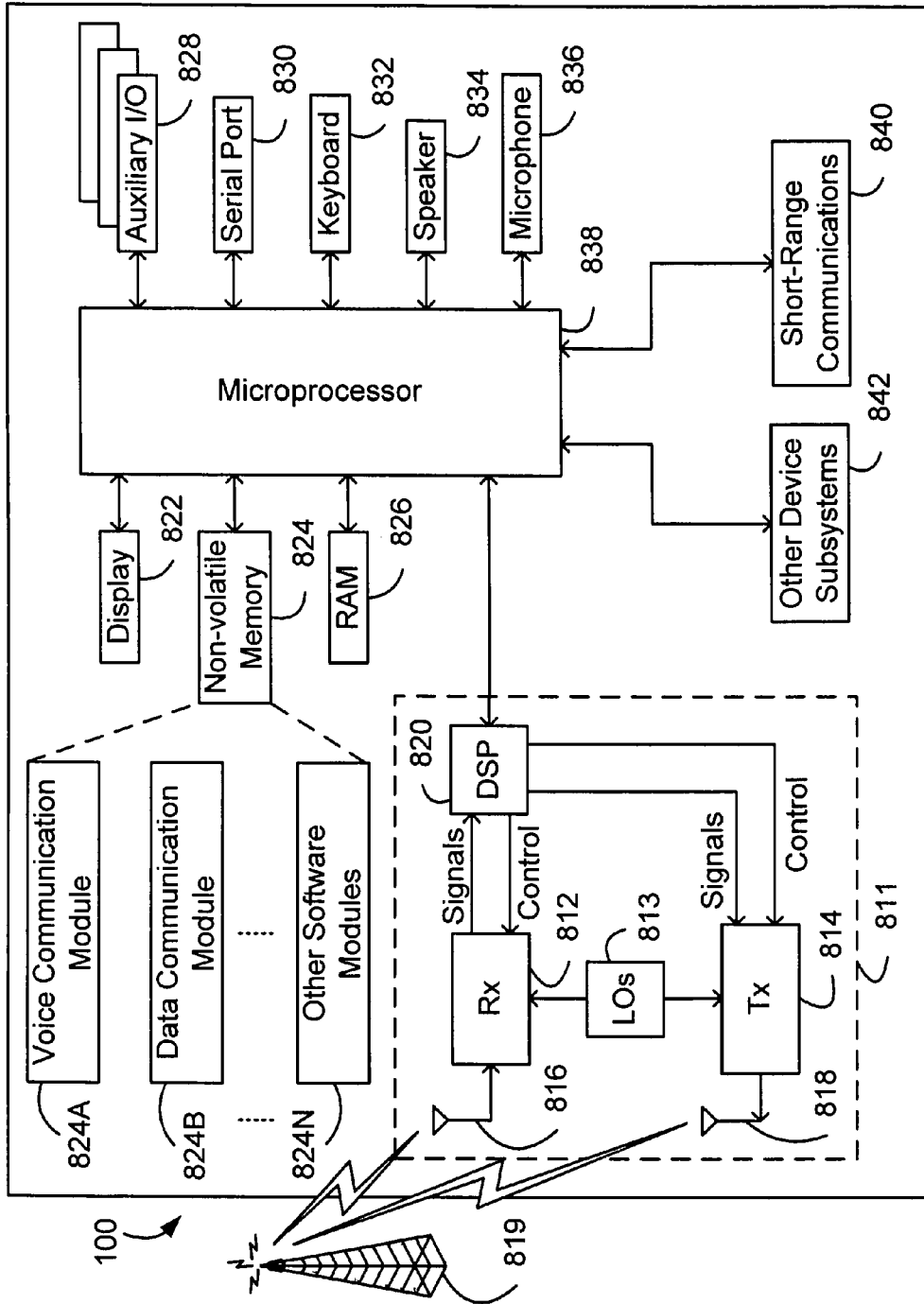

FIG. 11

## SYSTEM AND METHOD FOR HANDLING DATA TRANSFERS

**Matter enclosed in heavy brackets [ ] appears in the original patent but forms no part of this reissue specification; matter printed in italics indicates the additions made by reissue; a claim printed with strikethrough indicates that the claim was canceled, disclaimed, or held invalid by a prior post-patent action or proceeding.**

### CROSS-REFERENCE TO RELATED APPLICATIONS

*More than one reissue applications have been filed.* This application is a continuation of [the U.S. patent application Ser. No. 11/118,791, filed Apr. 29, 2005, entitled "SYSTEM AND METHOD FOR HANDLING DATA TRANSFERS." This application and the '791 application claim priority to and the benefit of commonly assigned U.S. Provisional Application having Ser. No.] *U.S. patent application Ser. No. 15/177,759 filed on Jun. 9, 2016, and is also a reissue of U.S. patent application Ser. No. 12/795,252 filed Jun. 7, 2010, now issued as U.S. Pat. No. 8,005,469. U.S. patent application Ser. No. 15/177,759 is a continuation of 14/163,416 filed Jan. 24, 2014, now issued as U.S. Pat. No. RE46,083 and is also a reissue of 12/795,252 filed Jun. 7, 2010, now issued as U.S. Pat. No. 8,005,469. U.S. patent application Ser. No. 14/163,416 is a continuation of 13/490,956 filed Jun. 7, 2012, now issued as U.S. Pat. No. RE44,746 and is also a reissue of 12/795,252 filed Jun. 7, 2010, now issued as U.S. Pat. No. 8,005,469. U.S. patent application Ser. No. 13/490,956 is a reissue of U.S. patent application Ser. No. 12/795,252 filed Jun. 7, 2010, now issued as U.S. Pat. No. 8,005,469 on Aug. 23, 2011, which is a continuation of U.S. patent application Ser. No. 11/118,791 filed Apr. 29, 2005, now issued as U.S. Pat. No. 7,734,284 on Jun. 8, 2010, which claims the benefit of priority to U.S. Provisional Patent Application No. 60/567,293, filed on Apr. 30, 2004, entitled "SYSTEM AND METHOD FOR HANDLING DATA TRANSFERS."* All of these are hereby incorporated into this application by reference.

### BACKGROUND

#### 1. Technical Field

This document relates generally to the field of communications, and in particular to handling data transfers that involve mobile wireless communications devices.

#### 2. Description of the Related Art

Some companies or governments have different types of networks based on different levels of security. Some of the networks are more secure than others and provide additional levels of security, as well as different procedures for using that network. It is a security concern for data to move between the networks, specifically from a more secure network to a weaker network. An additional problem is how to prevent a malicious application from siphoning data from inside a corporation's firewall to outside the firewall.

For example the government may have a secret network and a non-secret network. The workstations on the secret network may not even be connected to the non-secret network to explicitly prevent data siphoning. To prevent data siphoning between these networks for mobile communications, the government would have to deploy two separate PDAs to each employee that uses both of the networks. This is a costly approach.

As another example, an organization may wish to deploy handhelds to employees, which connect to their corporate network as well as their personal (home) email accounts. It would be detrimental for an employee to siphon data between their corporate secure network to their personal accounts.

### BRIEF DESCRIPTION OF THE DRAWINGS

FIG. 1 is an overview of an example communication system in which a wireless communication device may be used.

FIG. 2 is a block diagram of a further example communication system including multiple networks and multiple mobile communication devices.

FIGS. 3 and 4 are block diagrams depicting management of data transfers between a secure location and a less secure location.

FIG. 5 is a block diagram depicting an IT administrator providing data transfer settings to a mobile device.

FIGS. 6 and 7 are flowcharts depicting a data transfer operational scenario.

FIG. 8 is a block diagram depicting a data transfer prevention feature wherein data forwarding between service books is prevented.

FIG. 9 is a block diagram depicting a data transfer prevention feature wherein cut/copy/paste operations are disabled for applications on a mobile device.

FIG. 10 is a block diagram depicting a data transfer prevention feature wherein Inter-Process Communication (IPC) are disabled between applications operating on a mobile device.

FIG. 11 is a block diagram of an example mobile device.

### DETAILED DESCRIPTION OF THE DRAWINGS

FIG. 1 is an overview of an example communication system in which a wireless communication device may be used. One skilled in the art will appreciate that there may be many different topologies, but the system shown in FIG. 1 helps demonstrate the operation of the encoded message processing systems and methods described in the present application. There may also be many message senders and recipients. The simple system shown in FIG. 1 is for illustrative purposes only, and shows perhaps the most prevalent Internet e-mail environment where security is not generally used.

FIG. 1 shows an e-mail sender 10, the Internet 20, a message server system 40, a wireless gateway 85, wireless infrastructure 90, a wireless network 105 and a mobile communication device 100.

An e-mail sender system 10 may, for example, be connected to an ISP (Internet Service Provider) on which a user of the system 10 has an account, located within a company, possibly connected to a local area network (LAN), and connected to the Internet 20, or connected to the Internet 20 through a large ASP (application service provider) such as America Online (AOL). Those skilled in the art will appreciate that the systems shown in FIG. 1 may instead be connected to a wide area network (WAN) other than the Internet, although e-mail transfers are commonly accomplished through Internet-connected arrangements as shown in FIG. 1.

The message server 40 may be implemented, for example, on a network computer within the firewall of a corporation, a computer within an ISP or ASP system or the like, and acts as the main interface for e-mail exchange over the Internet

20. Although other messaging systems might not require a message server system **40**, a mobile device **100** configured for receiving and possibly sending e-mail will normally be associated with an account on a message server. Perhaps the two most common message servers are Microsoft Exchange™ and Lotus Domino™. These products are often used in conjunction with Internet mail routers that route and deliver mail. These intermediate components are not shown in FIG. 1, as they do not directly play a role in the secure message processing described below. Message servers such as server **40** typically extend beyond just e-mail sending and receiving; they also include dynamic database storage engines that have predefined database formats for data like calendars, to-do lists, task lists, e-mail and documentation.

The wireless gateway **85** and infrastructure **90** provide a link between the Internet **20** and wireless network **105**. The wireless infrastructure **90** determines the most likely network for locating a given user and tracks the user as they roam between countries or networks. A message is then delivered to the mobile device **100** via wireless transmission, typically at a radio frequency (RF), from a base station in the wireless network **105** to the mobile device **100**. The particular network **105** may be virtually any wireless network over which messages may be exchanged with a mobile communication device.

As shown in FIG. 1, a composed e-mail message **15** is sent by the e-mail sender **10**, located somewhere on the Internet **20**. This message **15** is normally fully in the clear and uses traditional Simple Mail Transfer Protocol (SMTP), RFC822 headers and Multipurpose Internet Mail Extension (MIME) body parts to define the format of the mail message. These techniques are all well known to those skilled in the art. The message **15** arrives at the message server **40** and is normally stored in a message store. Most known messaging systems support a so-called "pull" message access scheme, wherein the mobile device **100** must request that stored messages be forwarded by the message server to the mobile device **100**. Some systems provide for automatic routing of such messages which are addressed using a specific e-mail address associated with the mobile device **100**. In a preferred embodiment described in further detail below, messages addressed to a message server account associated with a host system such as a home computer or office computer which belongs to the user of a mobile device **100** are redirected from the message server **40** to the mobile device **100** as they are received.

Regardless of the specific mechanism controlling the forwarding of messages to the mobile device **100**, the message **15**, or possibly a translated or reformatted version thereof, is sent to the wireless gateway **85**. The wireless infrastructure **90** includes a series of connections to wireless network **105**. These connections could be Integrated Services Digital Network (ISDN), Frame Relay or T1 connections using the TCP/IP protocol used throughout the Internet. As used herein, the term "wireless network" is intended to include three different types of networks, those being (1) data-centric wireless networks, (2) voice-centric wireless networks and (3) dual-mode networks that can support both voice and data communications over the same physical base stations. Combined dual-mode networks include, but are not limited to, (1) Code Division Multiple Access (CDMA) networks, (2) the Groupe Special Mobile or the Global System for Mobile Communications (GSM) and the General Packet Radio Service (GPRS) networks, and (3) future third-generation (3G) networks like Enhanced Data-rates for Global Evolution (EDGE) and Universal Mobile Telecommunications Systems (UMTS). Some older examples of

data-centric network include the Mobitex™ Radio Network and the DataTAC™ Radio Network. Examples of older voice-centric data networks include Personal Communication Systems (PCS) networks like GSM, and TDMA systems.

FIG. 2 is a block diagram of a further example communication system including multiple networks and multiple mobile communication devices. The system of FIG. 2 is substantially similar to the FIG. 1 system, but includes a host system **30**, a redirection program **45**, a mobile device cradle **65**, a wireless virtual private network (VPN) router **75**, an additional wireless network **110** and multiple mobile communication devices **100**. As described above in conjunction with FIG. 1, FIG. 2 represents an overview of a sample network topology. Although the encoded message processing systems and methods described herein may be applied to networks having many different topologies, the network of FIG. 2 is useful in understanding an automatic e-mail redirection system mentioned briefly above.

The central host system **30** will typically be a corporate office or other LAN, but may instead be a home office computer or some other private system where mail messages are being exchanged. Within the host system **30** is the message server **40**, running on some computer within the firewall of the host system, that acts as the main interface for the host system to exchange e-mail with the Internet **20**. In the system of FIG. 2, the redirection program **45** enables redirection of data items from the server **40** to a mobile communication device **100**. Although the redirection program **45** is shown to reside on the same machine as the message server **40** for ease of presentation, there is no requirement that it must reside on the message server. The redirection program **45** and the message server **40** are designed to co-operate and interact to allow the pushing of information to mobile devices **100**. In this installation, the redirection program **45** takes confidential and non-confidential corporate information for a specific user and redirects it out through the corporate firewall to mobile devices **100**. A more detailed description of the redirection software **45** may be found in the commonly assigned U.S. Pat. No. 6,219,694 ("the '694 patent"), entitled "System and Method for Pushing Information From A Host System To A Mobile Data Communication Device Having A Shared Electronic Address", and issued to the assignee of the instant application on Apr. 17, 2001 which is hereby incorporated into the present application by reference. This push technique may use a wireless friendly encoding, compression and encryption technique to deliver all information to a mobile device, thus effectively extending the security firewall to include each mobile device **100** associated with the host system **30**.

As shown in FIG. 2, there may be many alternative paths for getting information to the mobile device **100**. One method for loading information onto the mobile device **100** is through a port designated **50**, using a device cradle **65**. This method tends to be useful for bulk information updates often performed at initialization of a mobile device **100** with the host system **30** or a computer **35** within the system **30**. The other main method for data exchange is over-the-air using wireless networks to deliver the information. As shown in FIG. 2, this may be accomplished through a wireless VPN router **75** or through a traditional Internet connection **95** to a wireless gateway **85** and a wireless infrastructure **90**, as described above. The concept of a wireless VPN router **75** is new in the wireless industry and implies that a VPN connection could be established directly through a specific wireless network **110** to a mobile device **100**. The possibility of using a wireless VPN router **75** has

only recently been available and could be used when the new Internet Protocol (IP) Version 6 (IPv6) arrives into IP-based wireless networks. This new protocol will provide enough IP addresses to dedicate an IP address to every mobile device **100** and thus make it possible to push information to a mobile device **100** at any time. A principal advantage of using this wireless VPN router **75** is that it could be an off-the-shelf VPN component, thus it would not require a separate wireless gateway **85** and wireless infrastructure **90** to be used. A VPN connection would preferably be a Transmission Control Protocol (TCP)/IP or User Datagram Protocol (UDP)/IP connection to deliver the messages directly to the mobile device **100**. If a wireless VPN **75** is not available then a link **95** to the Internet **20** is the most common connection mechanism available and has been described above.

In the automatic redirection system of FIG. 2, a composed e-mail message **15** leaving the e-mail sender **10** arrives at the message server **40** and is redirected by the redirection program **45** to the mobile device **100**. As this redirection takes place the message **15** is re-enveloped, as indicated at **80**, and a possibly proprietary compression and encryption algorithm can then be applied to the original message **15**. In this way, messages being read on the mobile device **100** are no less secure than if they were read on a desktop workstation such as **35** within the firewall. All messages exchanged between the redirection program **45** and the mobile device **100** preferably use this message repackaging technique. Another goal of this outer envelope is to maintain the addressing information of the original message except the sender's and the receiver's address. This allows reply messages to reach the appropriate destination, and also allows the "from" field to reflect the mobile user's desktop address. Using the user's e-mail address from the mobile device **100** allows the received message to appear as though the message originated from the user's desktop system **35** rather than the mobile device **100**.

With reference back to the port **50** and cradle **65** connectivity to the mobile device **100**, this connection path offers many advantages for enabling one-time data exchange of large items. For those skilled in the art of personal digital assistants (PDAs) and synchronization, the most common data exchanged over this link is Personal Information Management (PIM) data **55**. When exchanged for the first time this data tends to be large in quantity, bulky in nature and requires a large bandwidth to get loaded onto the mobile device **100** where it can be used on the road. This serial link may also be used for other purposes, including setting up a private security key **111** such as an S/MIME or PGP specific private key, the Certificate (Cert) of the user and their Certificate Revocation Lists (CRLs) **60**. The private key is preferably exchanged so that the desktop **35** and mobile device **100** share one personality and one method for accessing all mail. The Cert and CRLs are normally exchanged over such a link because they represent a large amount of the data that is required by the device for S/MIME, PGP and other public key security methods.

FIG. 3 depicts a system wherein data transfers **230** between a secure location **220** and a less secure location **240** is managed on a mobile device **100** by a data transfer checker **202**. A data transfer checker **202** can be implemented on a mobile device **100** as a software routine or in hardware or firmware. FIG. 4 provides several examples of locations **220** and **240**. For example, location **220** may be a top-secret or secure network and location **240** may be an unrestricted network.

As another example, location **220** may be a first application that has received sensitive or confidential information. An attempt to transfer data from the first application to a second application may be prevented by the data transfer checker **202** because if the data transfer is successful to the second application, then the second application might be used to disseminate the sensitive data to an unsecured location.

FIG. 5 depicts an IT (information technology) administrator **250** (or its agent) providing data transfer criterion or settings **252** to a mobile device **100**. The settings **252** can indicate what data transfers **230** are permitted and which ones are not permitted. The settings **252** can be stored in a data store **204** located on the mobile device **100** for access by a data transfer checker **202**.

The IT administrator **250** can specify data transfer settings **252** to one or more devices. The settings **252** may be provided to the mobile device **100** over a network (or other data connection mechanism) in order to update the data store **204** on the mobile device **100**. The mobile device **100** can be preprogrammed with the settings and can be updated by the IT administrator **250** or can have the initial settings provided by the IT administrator **250**.

This provides, among other things, companies with the capability to customize data transfer settings to suit their needs. Also, an IT administrator **250** can provide the same settings to all mobile devices of the company, thereby ensuring that company mobile devices adhere to a consistent IT policy.

An IT policy can be enforced upon mobile devices in many ways, such as through the approaches described in the following commonly assigned United States patent application which is hereby incorporated by reference: "System And Method Of Owner Control Of Electronic Devices" (Ser. No. 10/732,132 filed on Dec. 10, 2003). This document illustrates how a user of the mobile device can be prevented from altering or erasing owner control information (e.g., data transfer settings **252**) specified by an IT administrator **250**.

FIGS. 6 and 7 illustrate a data transfer operational scenario **300**. At step **302** in the operational scenario, data transfer settings can be provided to one or more mobile devices by IT administration personnel. A company's IT policy can specify that many different data transfer-related features can be enabled/disabled. As an illustration, the data transfer settings can enable/disable such security-related aspects associated with data transfers as the following:

- whether data forwarding between service books should be allowed.
- whether cut/copy/paste operations between applications should be allowed.
- whether applications should be prevented from opening an internal and an external connection.
- whether IPC (interprocess communication) should be allowed between applications.

Using one or more of these features, the company can help ensure that their private data is kept secure. The data transfer settings are stored at step **304** in one or more data stores that are located on the mobile device.

At step **306**, there is an attempt in this operational scenario to transfer data from a first location to a second location. Step **310** retrieves the data transfer settings, and decision step **312** examines whether the data transfer should occur in view of the data transfer settings. If the data transfer should occur as determined by decision step **312**, then the

data transfer occurs between the first location and the second location, and processing for this operational scenario terminates at end block **320**.

However, if decision step **312** determines that the data transfer should not be allowed in view of the settings, then decision step **316** determines whether the user should be notified that the data transfer is not permitted. If the user is not to be notified (e.g., because the settings do not allow a feedback message), then processing for this operational scenario terminates at end block **320**. However, if the user is to be notified as determined by decision block **316**, then an indication is provided at step **318** to the user that the data transfer is being prevented. Processing for this operational scenario terminates at end block **320**.

It should be understood that similar to the other processing flows described herein, the steps and the order of the steps in the flowchart described herein may be altered, modified and/or augmented and still achieve the desired outcome.

FIG. **8** illustrates a data transfer prevention feature mentioned above wherein data transfer **410** between services (**400**, **420**) is prevented. Exemplary services comprise a company email service, a user's personal e-mail service, and an instant messaging service. This data transfer prevention feature allows the company to disable improper forwarding/replying between services. For example, if a user receives an email message via a first service **400**, the user is unable to forward it to another email account via a second service **420** (such as a personal e-mail account of the user). Optionally, messages **440** that arrive via a source e-mail server **430** must be replied to or forwarded back through the same source e-mail server **430** from which the message **440** arrived.

FIG. **9** illustrates a data transfer prevention feature mentioned above wherein cut/copy/paste operations **510** are disabled for all or designated applications on the handheld mobile device **100**. As an illustration, even if the forwarding between applications or services is disabled, a determined user may copy messages from one application **500**, compose a new message in a different application **520** and send it through the different application **520**. Disabling cut/copy/paste operations makes this much more difficult for the user to siphon data because they would be forced to retype the entire message or data.

FIG. **10** illustrates a data transfer prevention feature mentioned above wherein Inter-Process Communication (IPC) **710** can be disabled between applications (**700**, **720**) that operate on a mobile device **100**. As is known to one skilled in the art, an application may initiate one or more processes in order to accomplish certain tasks on the handheld mobile device **100**. This data transfer prevention feature would prevent two malicious applications (**700**, **720**) working together to siphon data. As an example, one application **700** could open up a connection inside the firewall, and another application **720** could open a connection outside the firewall. Then using IPC **710**, they could transfer data between the two applications (**700**, **720**) and effectively siphon data. Disabling IPC between the applications (**700**, **720**) prevents this type of attack from occurring.

The data transfer prevention provided by a data transfer checker **202** would inadvertently prohibit IPC between an e-mail program and an address book that are operating on the mobile device **100**. Thus, a company can additionally choose which applications are allowed to use IPC, as some applications, such as the e-mail program and the address book, may have a valid use for it.

The systems and methods disclosed herein are presented only by way of example and are not meant to limit the scope

of the invention. Other variations of the systems and methods described above will be apparent to those skilled in the art and as such are considered to be within the scope of the invention. For example, a system and method can be configured to include the following. A data transfer checker operating on a mobile device determines whether an attempted data transfer between two locations is permitted. If it is not permitted, then the data transfer is prevented and the user may be notified of the data transfer prevention.

As another example of a system and method, a system and method can receive a data transfer request to transfer data from a first location to a second location, wherein the first location is more secure than the second location. Data transfer settings are retrieved from a data store responsive to receiving the data transfer request. The data transfer settings indicate whether a data transfer is to occur based upon a security-related aspect associated with the data transfer. The data transfer settings are used to determine whether to transfer the data from the first location to the second location based upon the data transfer settings. The data is transferred responsive to the determining step.

A system and method may be configured to consider one or more different data transfer security-related aspects, such as level of security associated with the destination of the data transfer. As other examples, a security related aspect can include the type of communication operation to be performed between the first location and the second location such as the type of communication to occur. The type of data transfer operation could include data forwarding between service books, opening an internal and an external connection, an Inter-Process Communication (IPC) between applications, and/or a cut-copy-paste type operation between applications.

As another example, the systems and methods disclosed herein may be used with many different computers and devices, such as a wireless mobile communications device shown in FIG. **11**. With reference to FIG. **11**, the mobile device **100** is a dual-mode mobile device and includes a transceiver **811**, a microprocessor **838**, a display **822**, non-volatile memory **824**, random access memory (RAM) **826**, one or more auxiliary input/output (I/O) devices **828**, a serial port **830**, a keyboard **832**, a speaker **834**, a microphone **836**, a short-range wireless communications sub-system **840**, and other device sub-systems **842**.

The transceiver **811** includes a receiver **812**, a transmitter **814**, antennas **816** and **818**, one or more local oscillators **813**, and a digital signal processor (DSP) **820**. The antennas **816** and **818** may be antenna elements of a multiple-element antenna, and are preferably embedded antennas. However, the systems and methods described herein are in no way restricted to a particular type of antenna, or even to wireless communication devices.

The mobile device **100** is preferably a two-way communication device having voice and data communication capabilities. Thus, for example, the mobile device **100** may communicate over a voice network, such as any of the analog or digital cellular networks, and may also communicate over a data network. The voice and data networks are depicted in FIG. **11** by the communication tower **819**. These voice and data networks may be separate communication networks using separate infrastructure, such as base stations, network controllers, etc., or they may be integrated into a single wireless network.

The transceiver **811** is used to communicate with the network **819**, and includes the receiver **812**, the transmitter **814**, the one or more local oscillators **813** and the DSP **820**. The DSP **820** is used to send and receive signals to and from

the transceivers **816** and **818**, and also provides control information to the receiver **812** and the transmitter **814**. If the voice and data communications occur at a single frequency, or closely-spaced sets of frequencies, then a single local oscillator **813** may be used in conjunction with the receiver **812** and the transmitter **814**. Alternatively, if different frequencies are utilized for voice communications versus data communications for example, then a plurality of local oscillators **813** can be used to generate a plurality of frequencies corresponding to the voice and data networks **819**. Information, which includes both voice and data information, is communicated to and from the transceiver **811** via a link between the DSP **820** and the microprocessor **838**.

The detailed design of the transceiver **811**, such as frequency band, component selection, power level, etc., will be dependent upon the communication network **819** in which the mobile device **100** is intended to operate. For example, a mobile device **100** intended to operate in a North American market may include a transceiver **811** designed to operate with any of a variety of voice communication networks, such as the Mobitex or DataTAC mobile data communication networks, AMPS, TDMA, CDMA, PCS, etc., whereas a mobile device **100** intended for use in Europe may be configured to operate with the GPRS data communication network and the GSM voice communication network. Other types of data and voice networks, both separate and integrated, may also be utilized with a mobile device **100**.

Depending upon the type of network or networks **819**, the access requirements for the mobile device **100** may also vary. For example, in the Mobitex and DataTAC data networks, mobile devices are registered on the network using a unique identification number associated with each mobile device. In GPRS data networks, however, network access is associated with a subscriber or user of a mobile device. A GPRS device typically requires a subscriber identity module ("SIM"), which is required in order to operate a mobile device on a GPRS network. Local or non-network communication functions (if any) may be operable, without the SIM device, but a mobile device will be unable to carry out any functions involving communications over the data network **819**, other than any legally required operations, such as '911' emergency calling.

After any required network registration or activation procedures have been completed, the mobile device **100** may send and receive communication signals, including both voice and data signals, over the networks **819**. Signals received by the antenna **816** from the communication network **819** are routed to the receiver **812**, which provides for signal amplification, frequency down conversion, filtering, channel selection, etc., and may also provide analog to digital conversion. Analog to digital conversion of the received signal allows more complex communication functions, such as digital demodulation and decoding to be performed using the DSP **820**. In a similar manner, signals to be transmitted to the network **819** are processed, including modulation and encoding, for example, by the DSP **820** and are then provided to the transmitter **814** for digital to analog conversion, frequency up conversion, filtering, amplification and transmission to the communication network **819** via the antenna **818**.

In addition to processing the communication signals, the DSP **820** also provides for transceiver control. For example, the gain levels applied to communication signals in the receiver **812** and the transmitter **814** may be adaptively controlled through automatic gain control algorithms implemented in the DSP **820**. Other transceiver control algorithms

could also be implemented in the DSP **820** in order to provide more sophisticated control of the transceiver **811**.

The microprocessor **838** preferably manages and controls the overall operation of the mobile device **100**. Many types of microprocessors or microcontrollers could be used here, or, alternatively, a single DSP **820** could be used to carry out the functions of the microprocessor **838**. Low-level communication functions, including at least data and voice communications, are performed through the DSP **820** in the transceiver **811**. Other, high-level communication applications, such as a voice communication application **824A**, and a data communication application **824B** may be stored in the non-volatile memory **824** for execution by the microprocessor **838**. For example, the voice communication module **824A** may provide a high-level user interface operable to transmit and receive voice calls between the mobile device **100** and a plurality of other voice or dual-mode devices via the network **819**. Similarly, the data communication module **824B** may provide a high-level user interface operable for sending and receiving data, such as e-mail messages, files, organizer information, short text messages, etc., between the mobile device **100** and a plurality of other data devices via the networks **819**.

The microprocessor **838** also interacts with other device subsystems, such as the display **822**, the RAM **826**, the auxiliary input/output (I/O) subsystems **828**, the serial port **830**, the keyboard **832**, the speaker **834**, the microphone **836**, the short-range communications subsystem **840** and any other device subsystems generally designated as **842**.

Some of the subsystems shown in FIG. **11** perform communication-related functions, whereas other subsystems may provide "resident" or on-device functions. Notably, some subsystems, such as the keyboard **832** and the display **822** may be used for both communication-related functions, such as entering a text message for transmission over a data communication network, and device-resident functions such as a calculator or task list or other PDA type functions.

Operating system software used by the microprocessor **838** is preferably stored in a persistent store such as non-volatile memory **824**. The non-volatile memory **824** may be implemented, for example, as a Flash memory component, or as battery backed-up RAM. In addition to the operating system, which controls low-level functions of the mobile device **100**, the non-volatile memory **824** includes a plurality of software modules **824A-824N** that can be executed by the microprocessor **838** (and/or the DSP **820**), including a voice communication module **824A**, a data communication module **824B**, and a plurality of other operational modules **824N** for carrying out a plurality of other functions. These modules are executed by the microprocessor **838** and provide a high-level interface between a user and the mobile device **100**. This interface typically includes a graphical component provided through the display **822**, and an input/output component provided through the auxiliary I/O **828**, keyboard **832**, speaker **834**, and microphone **836**. The operating system, specific device applications or modules, or parts thereof, may be temporarily loaded into a volatile store, such as RAM **826** for faster operation. Moreover, received communication signals may also be temporarily stored to RAM **826**, before permanently writing them to a file system located in a persistent store such as the Flash memory **824**.

An exemplary application module **824N** that may be loaded onto the mobile device **100** is a personal information manager (PIM) application providing PDA functionality, such as calendar events, appointments, and task items. This module **824N** may also interact with the voice communica-

tion module **824A** for managing phone calls, voice mails, etc., and may also interact with the data communication module for managing e-mail communications and other data transmissions. Alternatively, all of the functionality of the voice communication module **824A** and the data communication module **824B** may be integrated into the PIM module.

The non-volatile memory **824** preferably also provides a file system to facilitate storage of PIM data items on the device. The PIM application preferably includes the ability to send and receive data items, either by itself, or in conjunction with the voice and data communication modules **824A**, **824B**, via the wireless networks **819**. The PIM data items are preferably seamlessly integrated, synchronized and updated, via the wireless networks **819**, with a corresponding set of data items stored or associated with a host computer system, thereby creating a mirrored system for data items associated with a particular user.

Context objects representing at least partially decoded data items, as well as fully decoded data items, are preferably stored on the mobile device **100** in a volatile and non-persistent store such as the RAM **826**. Such information may instead be stored in the non-volatile memory **824**, for example, when storage intervals are relatively short, such that the information is removed from memory soon after it is stored. However, storage of this information in the RAM **826** or another volatile and non-persistent store is preferred, in order to ensure that the information is erased from memory when the mobile device **100** loses power. This prevents an unauthorized party from obtaining any stored decoded or partially decoded information by removing a memory chip from the mobile device **100**, for example.

The mobile device **100** may be manually synchronized with a host system by placing the device **100** in an interface cradle, which couples the serial port **830** of the mobile device **100** to the serial port of a computer system or device. The serial port **830** may also be used to enable a user to set preferences through an external device or software application, or to download other application modules **824N** for installation. This wired download path may be used to load an encryption key onto the device, which is a more secure method than exchanging encryption information via the wireless network **819**. Interfaces for other wired download paths may be provided in the mobile device **100**, in addition to or instead of the serial port **830**. For example, a USB port would provide an interface to a similarly equipped personal computer.

Additional application modules **824N** may be loaded onto the mobile device **100** through the networks **819**, through an auxiliary I/O subsystem **828**, through the serial port **830**, through the short-range communications subsystem **840**, or through any other suitable subsystem **842**, and installed by a user in the non-volatile memory **824** or RAM **826**. Such flexibility in application installation increases the functionality of the mobile device **100** and may provide enhanced on-device functions, communication-related functions, or both. For example, secure communication applications may enable electronic commerce functions and other such financial transactions to be performed using the mobile device **100**.

When the mobile device **100** is operating in a data communication mode, a received signal, such as a text message or a web page download, is processed by the transceiver module **811** and provided to the microprocessor **838**, which preferably further processes the received signal in multiple stages as described above, for eventual output to the display **822**, or, alternatively, to an auxiliary I/O device **828**. A user of mobile device **100** may also compose data

items, such as e-mail messages, using the keyboard **832**, which is preferably a complete alphanumeric keyboard laid out in the QWERTY style, although other styles of complete alphanumeric keyboards such as the known DVORAK style may also be used. User input to the mobile device **100** is further enhanced with a plurality of auxiliary I/O devices **828**, which may include a thumbwheel input device, a touchpad, a variety of switches, a rocker input switch, etc. The composed data items input by the user may then be transmitted over the communication networks **819** via the transceiver module **811**.

When the mobile device **100** is operating in a voice communication mode, the overall operation of the mobile device is substantially similar to the data mode, except that received signals are preferably be output to the speaker **834** and voice signals for transmission are generated by a microphone **836**. Alternative voice or audio I/O subsystems, such as a voice message recording subsystem, may also be implemented on the mobile device **100**. Although voice or audio signal output is preferably accomplished primarily through the speaker **834**, the display **822** may also be used to provide an indication of the identity of a calling party, the duration of a voice call, or other voice call related information. For example, the microprocessor **838**, in conjunction with the voice communication module and the operating system software, may detect the caller identification information of an incoming voice call and display it on the display **822**.

A short-range communications subsystem **840** is also included in the mobile device **100**. The subsystem **840** may include an infrared device and associated circuits and components, or a short-range RF communication module such as a Bluetooth™ module or an 802.11 module, for example, to provide for communication with similarly-enabled systems and devices. Those skilled in the art will appreciate that “Bluetooth” and “802.11” refer to sets of specifications, available from the Institute of Electrical and Electronics Engineers, relating to wireless personal area networks and wireless local area networks, respectively.

The systems’ and methods’ data may be stored in one or more data stores. The data stores can be of many different types of storage devices and programming constructs, such as RAM, ROM, Flash memory, programming data structures, programming variables, etc. It is noted that data structures describe formats for use in organizing and storing data in databases, programs, memory, or other computer-readable media for use by a computer program.

The systems and methods may be provided on many different types of computer-readable media including computer storage mechanisms (e.g., CD-ROM, diskette, RAM, flash memory, computer’s hard drive, etc.) that contain instructions for use in execution by a processor to perform the methods’ operations and implement the systems described herein.

The computer components, software modules, functions and data structures described herein may be connected directly or indirectly to each other in order to allow the flow of data needed for their operations. It is also noted that a module or processor includes but is not limited to a unit of code that performs a software operation, and can be implemented for example as a subroutine unit of code, or as a software function unit of code, or as an object (as in an object-oriented paradigm), or as an applet, or in a computer script language, or as another type of computer code. The software components and/or functionality may be located on a single computing device or distributed across multiple computing devices depending upon the situation at hand.

13

What is claimed is:

**[1.** A method of handling data transfers on a device, comprising:

receiving, from an application that accesses data associated with a first location, a request to open a connection with a second location;

retrieving, from a data store on the device, one or more data transfer settings responsive to receiving the request;

wherein the one or more data transfer settings are indicative of a security-related policy for data transfers associated with the first location; and

determining whether to permit the request or not permit the request based upon the one or more data transfer settings.]

**[2.** The method of claim 1, wherein the first location comprises a server, wherein the second location comprises a server, and wherein the request is to open the connection via a network.]

**[3.** The method of claim 1, wherein the application is a first application, wherein the second location comprises a second application, wherein the request is to open the connection for Inter-Process Communication (IPC) from the first application to the second application.]

**[4.** The method of claim 1, wherein the determining comprises using a level of security associated with the first location, and using a level of security associated with the second location.]

**[5.** The method of claim 1, wherein receiving the request comprises receiving a request to transfer data from the application running on the device to another application on the device.]

**[6.** The method of claim 1, wherein receiving the request comprises receiving a request to transfer data from the device to another device.]

**[7.** The method of claim 1, further comprising: receiving the one or more data transfer settings from a server via a wireless network.]

**[8.** A device, comprising:

a data store that stores a data transfer setting, wherein the data transfer setting is indicative of a security-related policy for data transfers associated with a first location; and

a processor configured to perform operations comprising: receiving, from an application that accesses data associated with the first location, a request to open a connection with a second location; retrieving, from the data store, the data transfer setting responsive to receiving the request; and determining whether to permit the request or not permit the request based upon the data transfer setting.]

**[9.** The device of claim 8, wherein the first location comprises a server, wherein the second location comprises a server, and wherein the request is to open the connection via a network.]

**[10.** The device of claim 8, wherein the application is a first application, wherein the second location comprises a second application, wherein the request is to open the connection for Inter-Process Communication (IPC) from the first application to the second application.]

**[11.** The device of claim 8, wherein the determining comprises using a level of security associated with the first location, and using a level of security associated with the second location.]

14

**[12.** The device of claim 8, wherein receiving the request comprises receiving a request to transfer data from the application running on the device to another application on the device.]

**[13.** The device of claim 8, wherein receiving the request comprises receiving a request to transfer data from the device to another device.]

**[14.** The device of claim 8, the operations further comprising:

receiving the data transfer setting from a server via a wireless network; and storing the data transfer setting in the data store.]

**[15.** A computer storage device encoded with a computer program, the program comprising instructions that when executed by a communication device cause the communication device to perform operations comprising:

receiving, from an application that accesses data associated with a first location, a request to open a connection with a second location;

retrieving, in response to receiving the request, one or more data transfer settings, which are indicative of a security-related policy for data transfers associated with the first location; and

determining whether to permit the request or not permit the request based upon the one or more data transfer settings.]

**[16.** The computer storage device of claim 15, wherein the first location comprises a server, wherein the second location comprises a server, and wherein the request is to open the connection via a network.]

**[17.** The computer storage device of claim 15, wherein the application is a first application, wherein the second location comprises a second application, wherein the request is to open the connection for Inter-Process Communication (IPC) from the first application to the second application.]

**[18.** The computer storage device of claim 15, wherein the determining comprises using a level of security associated with the first location, and using a level of security associated with the second location.]

**[19.** The computer storage device of claim 15, wherein receiving the request comprises receiving a request to transfer data from the application running on the communication device to another application on the communication device.]

**[20.** The computer storage device of claim 15, wherein receiving the request comprises receiving a request to transfer data from the communication device to another communication device.]

**[21.** The computer storage device of claim 15, the operations further comprising:

receiving the one or more data transfer settings from a server via a wireless network.]

*22. A method, comprising:*

*receiving a request to transfer data from a first application on a device to a second application on the device, wherein the first application is associated with an enterprise service and the second application is associated with a personal service;*

*determining that the request to transfer data from the first application on the device to the second application on the device is not to be executed based on a security policy that indicates whether data transferring from the enterprise service to the personal service on the same device is enabled or disabled; and*

*prohibiting the requested data transfer in response to the determining.*

15

23. The method of claim 22, wherein the security policy comprises one or more data transfer settings, and the request is determined not to be executed based on the one or more data transfer settings.

24. The method of claim 22, wherein the first application is associated with a company e-mail service and the second application is associated with a personal e-mail service.

25. The method of claim 22, wherein the data transfer includes pasting data cut or copied from the first application to the second application.

26. The method of claim 22, wherein the data transfer includes communicating using Inter-Process Communication (IPC) between the first application and the second application.

27. The method of claim 22, wherein the determining is based on a first security level associated with the first application and a second security level associated with the second application.

28. The method of claim 22, wherein prohibiting the data transfer comprises preventing the first application from establishing a connection with a first network while the second application is connected with a second network.

29. The method of claim 22, wherein prohibiting the data transfer comprises preventing transfer of the data between a first service book associated with the first application and a second service book associated with the second application.

30. A device, comprising:

at least one hardware processor;

one or more non-transitory computer-readable storage medium coupled to the at least one hardware processor and storing programming instructions for execution by the at least one hardware processor, wherein the programming instructions, when executed, cause the device to perform operations comprising:

receiving a request to transfer data from a first application on the device to a second application on the device, wherein the first application is associated with an enterprise service and the second application is associated with a personal service;

determining that the request to transfer data from the first application on the device to the second application on the device is not to be executed based on a security policy that indicates whether data transferring from the enterprise service to the personal service on the same device is enabled or disabled; and

prohibiting the requested data transfer in response to the determining.

31. The device of claim 30, wherein the security policy comprises one or more data transfer settings, and the request is determined not to be executed based on the one or more data transfer settings.

16

32. The device of claim 30, wherein the first application is associated with a company e-mail service and the second application is associated with a personal e-mail service.

33. The device of claim 30, wherein the data transfer includes a paste of data cut or copied from the first application to the second application.

34. The device of claim 30, wherein the data transfer includes a communication that uses Inter-Process Communication (IPC) between the first application and the second application.

35. The device of claim 30, wherein the determination is based on a first security level associated with the first application and a second security level associated with the second application.

36. The device of claim 30, wherein the prohibition of the data transfer comprises preventing the first application from establishing a connection with a first network while the second application is connected with a second network.

37. The device of claim 30, wherein the prohibition of the data transfer comprises preventing transfer of the data between a first service book associated with the first application and a second service book associated with the second application.

38. A non-transitory computer-readable medium containing instructions which, when executed, cause a device to perform operations comprising:

receiving a request to transfer data from a first application on the device to a second application on the device, wherein the first application is associated with an enterprise service and the second application is associated with a personal service;

determining that the request to transfer data from the first application on the device to the second application on the device is not to be executed based on a security policy that indicates whether data transferring from the enterprise service to the personal service on the same device is enabled or disabled; and

prohibiting the requested data transfer in response to the determining.

39. The non-transitory computer-readable medium of claim 38, wherein the security policy comprises one or more data transfer settings, and the request is determined not to be executed based on the one or more data transfer settings.

40. The non-transitory computer-readable medium of claim 38, wherein the first application is associated with a company e-mail service and the second application is associated with a personal e-mail service.

41. The non-transitory computer-readable medium of claim 38, wherein the data transfer includes pasting data cut or copied from the first application to the second application.

\* \* \* \* \*