





 **EUROPEAN PATENT APPLICATION**

 Application number: **81305201.6**

 Int. Cl.³: **G 03 G 15/00**
B 65 H 37/00, B 65 H 37/04

 Date of filing: **30.10.81**

 Priority: **17.12.80 US 217326**

 Applicant: **XEROX CORPORATION**
Xerox Square - 020
Rochester New York 14644(US)

 Date of publication of application:
23.06.82 Bulletin 82/25

 Inventor: **May, Joseph N.**
157 South Main Street
Fairport New York 14450(US)

 Date of deferred publication of search report: **29.09.82**

 Inventor: **Rhinehart, Stephen A.**
4031 S. Pin Oak Avenue
New Orleans Louisiana 70114(US)

 Designated Contracting States:
BE DE FR GB

 Inventor: **Zambelli, Robert G.**
575 Embury Road
Rochester New York 14625(US)

 Representative: **Prior, Nicholas J. European Patent**
Attorney et al,
Rank Xerox Patent Department 338 Euston Road
London NW1 3BH(GB)

 **A finishing apparatus and document reproduction system incorporating same.**

 A finishing apparatus (13) and a document reproduction system incorporating same are described as having a compiling station (102) for receiving a collated copy set (C) prior to stapling. The compiling station (102) is defined by a reciprocably movable, horizontally arranged collecting plate upon which the copy sheets (S) are collected. The arrangement presents the leading edge of the sheets to the clamping position of one or more staplers (110). After collection of the copy sheets (S), the leading edge of the set (C) is clamped and stapled while the plate (102) is moved to permit removal of the finishing set.

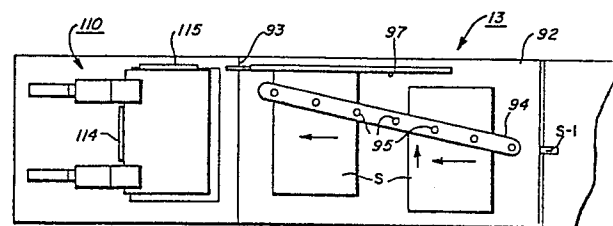

FIG. 2

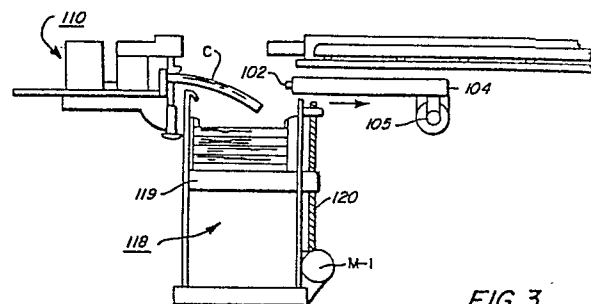

FIG. 3

EP 0 054 351 A3



DOCUMENTS CONSIDERED TO BE RELEVANT			CLASSIFICATION OF THE APPLICATION (Int. Cl. 3)
Category	Citation of document with indication, where appropriate, of relevant passages	Relevant to claim	
D,A	<u>US - A - 4 134 672</u> (L.E. BURLEW et al.) * fig. 1 * ---	1	G 03 G 15/00 B 65 H 37/00 B 65 H 37/04
D,A	<u>US - A - 3 719 266</u> (H. KORN et al.) * fig. 2 * ---	1	
D,A	<u>US - A - 4 029 309</u> (T. LYNCH et al.) * claims * ---	1	
A	<u>GB - A - 2 032 889</u> (XEROX) * page 3, lines 95 to 104; fig. 1 * ----	1	TECHNICAL FIELDS SEARCHED (Int.Cl. 3) B 65 H 29/00 B 65 H 31/00 B 65 H 37/00 G 03 B 27/00 G 03 G 15/00 G 03 G 21/00
			CATEGORY OF CITED DOCUMENTS X: particularly relevant if taken alone Y: particularly relevant if combined with another document of the same category A: technological background O: non-written disclosure P: intermediate document T: theory or principle underlying the invention E: earlier patent document, but published on, or after the filing date D: document cited in the application L: document cited for other reasons & member of the same patent family, corresponding document
<input checked="" type="checkbox"/> The present search report has been drawn up for all claims			
Place of search	Berlin	Date of completion of the search	02-07-1982
		Examiner	HOPPE