



US00D720944S

(12) **United States Design Patent**
Barber et al.

(10) **Patent No.:** **US D720,944 S**

(45) **Date of Patent:** **** *Jan. 13, 2015**

- (54) **SOFA**
- (71) Applicant: **Knoll, Inc.**, East Greenville, PA (US)
- (72) Inventors: **Edward Barber**, London (GB); **Jay Osgerby**, London (GB)
- (73) Assignee: **Knoll, Inc.**, East Greenville, PA (US)
- (*) Notice: This patent is subject to a terminal disclaimer.
- (**) Term: **14 Years**
- (21) Appl. No.: **29/487,227**

D515,333 S *	2/2006	Natuzzi	D6/381
D515,334 S *	2/2006	Natuzzi	D6/381
D527,541 S *	9/2006	Natuzzi	D6/381
D577,220 S *	9/2008	Natuzzi	D6/381
D600,037 S *	9/2009	Natuzzi	D6/381
D600,039 S *	9/2009	Natuzzi	D6/381
D600,938 S *	9/2009	Natuzzi	D6/381
D603,617 S *	11/2009	Weiss	D6/381
D677,071 S *	3/2013	Kanhasamy	D6/381
D677,490 S *	3/2013	Manzoni et al.	D6/381

* cited by examiner

Primary Examiner — Sandra Snapp
(74) *Attorney, Agent, or Firm* — Buchanan Ingersoll & Rooney PC

- (22) Filed: **Apr. 7, 2014**
- (51) **LOC (10) Cl.** **06-01**
- (52) **U.S. Cl.**
USPC **D6/381**
- (58) **Field of Classification Search**
CPC A47C 17/00; A47C 17/02; A47C 17/12;
A47C 17/18; A47C 7/021; A47C 31/00;
A47C 3/16
USPC D6/334, 335, 336, 379, 381; 297/94,
297/118, 232, 445.1, 448.1, DIG. 7
See application file for complete search history.

(57) **CLAIM**
The ornamental design for a sofa, as shown and described.

DESCRIPTION

FIG. 1 is a perspective view of a sofa showing our new design; FIG. 2 is a front elevational view thereof; FIG. 3 is a rear elevational view thereof; FIG. 4 is a top plan view thereof; FIG. 5 is a bottom plan view thereof; FIG. 6 is a left side elevational view thereof; and, FIG. 7 is a right side elevational view thereof. The broken away portions shown in the drawing Figures are meant to indicate indeterminate length and form no part of the claimed design.

- (56) **References Cited**
U.S. PATENT DOCUMENTS
D477,152 S * 7/2003 Levy D6/381
D493,039 S * 7/2004 Ricci D6/381

1 Claim, 5 Drawing Sheets

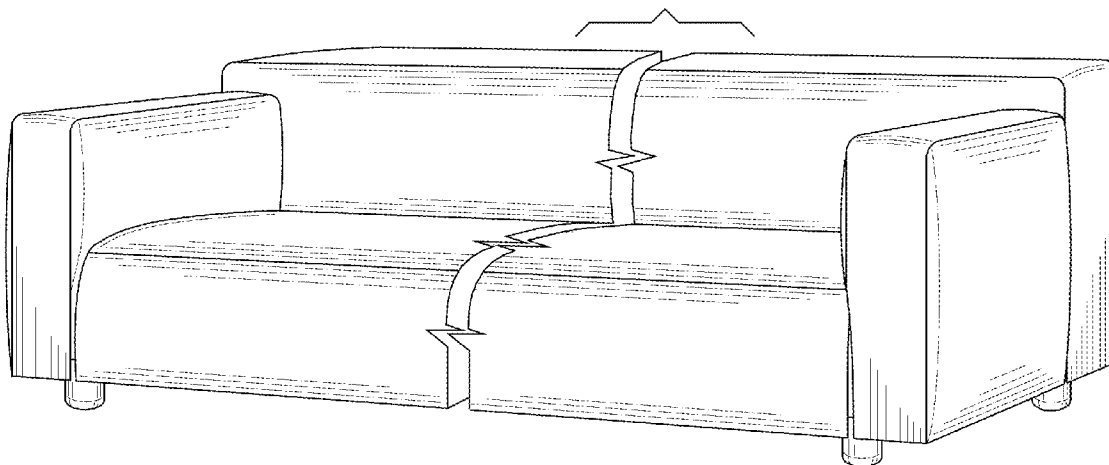

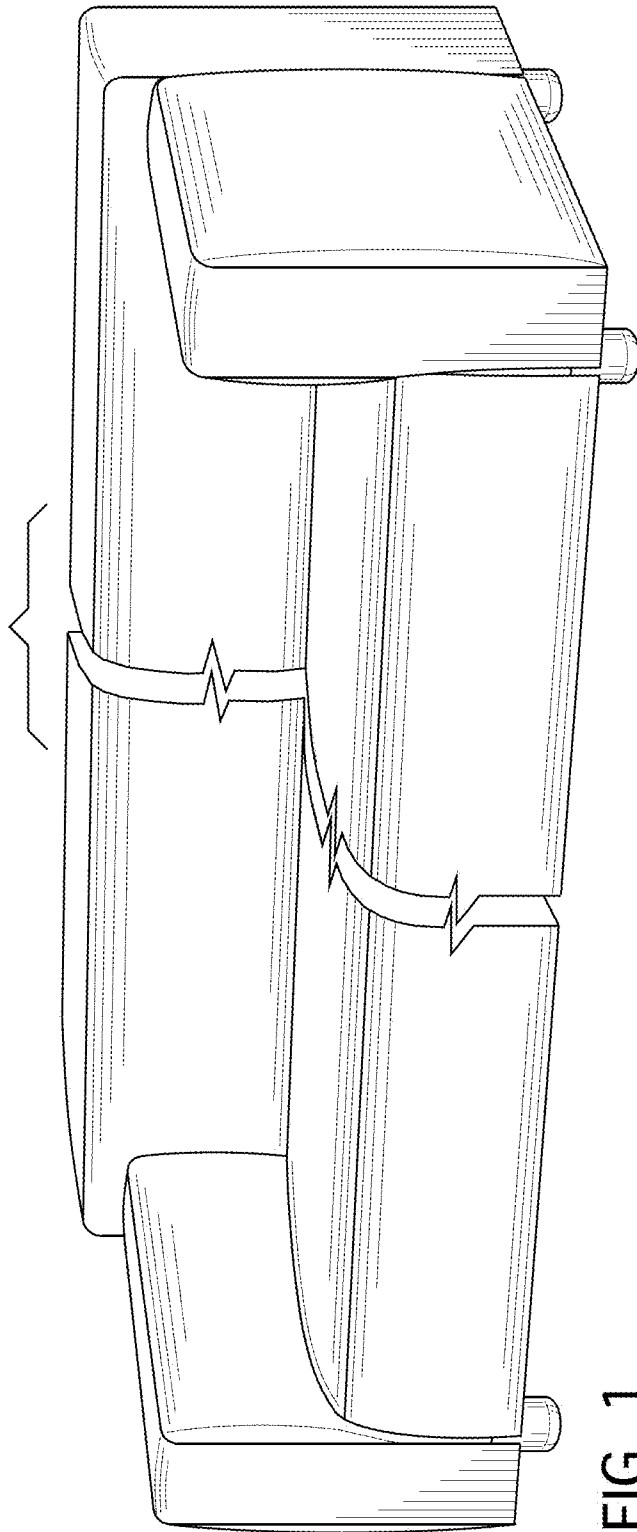

FIG. 1

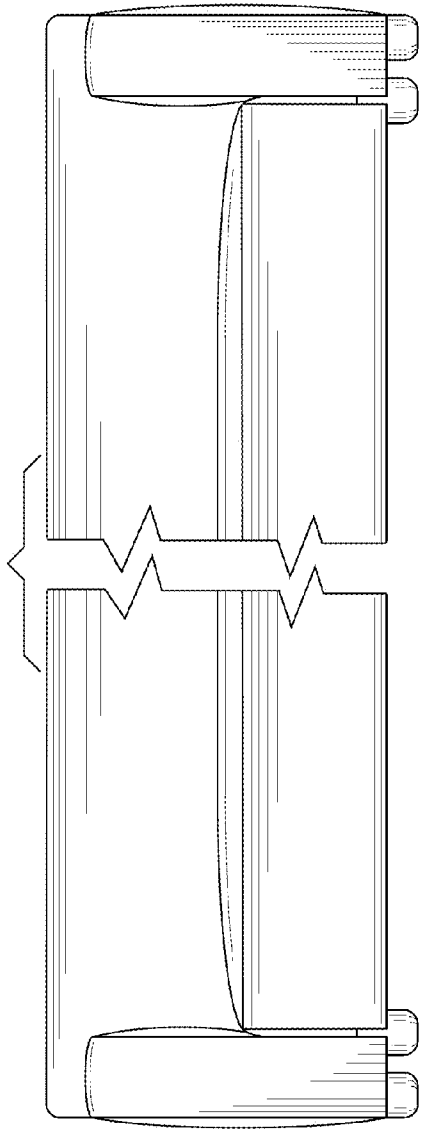

FIG. 2

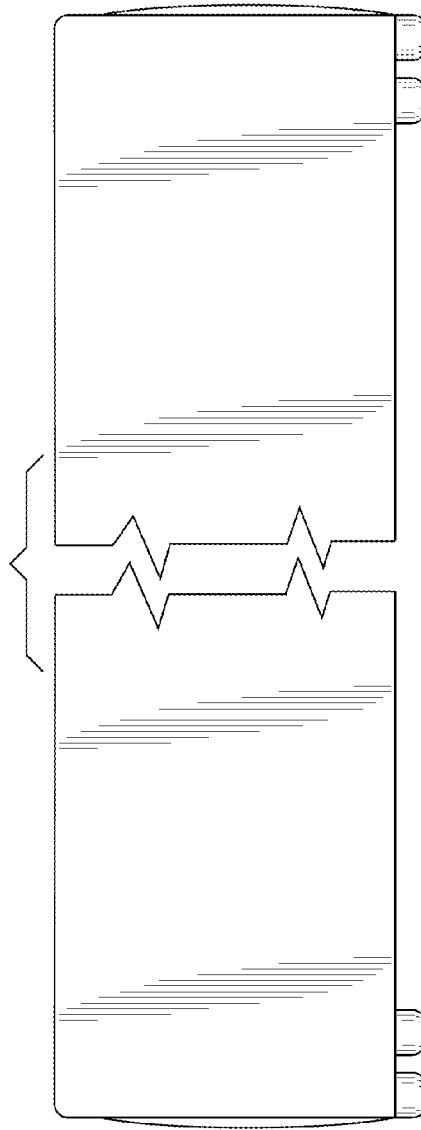

FIG. 3

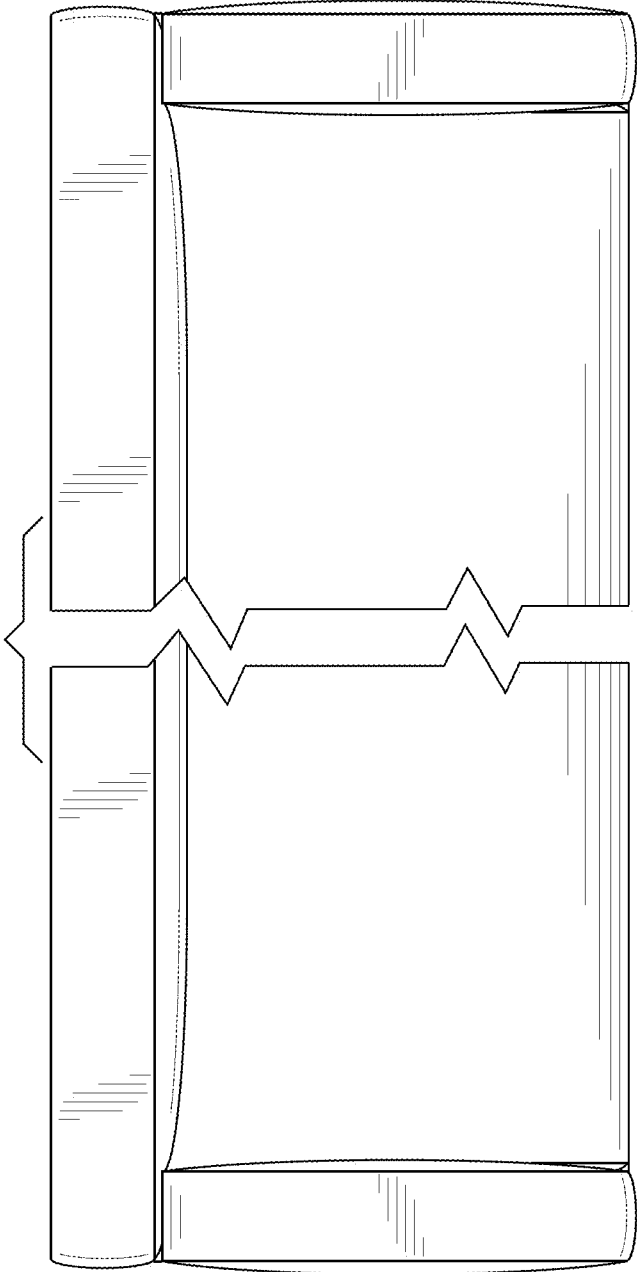

FIG. 4

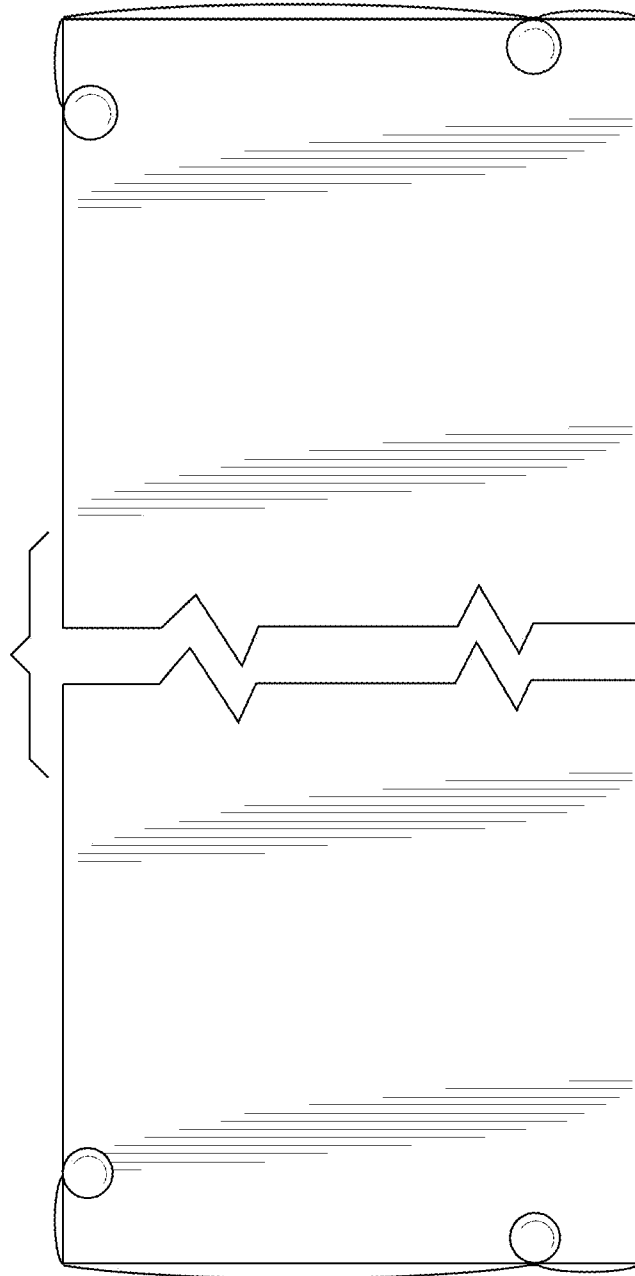

FIG. 5

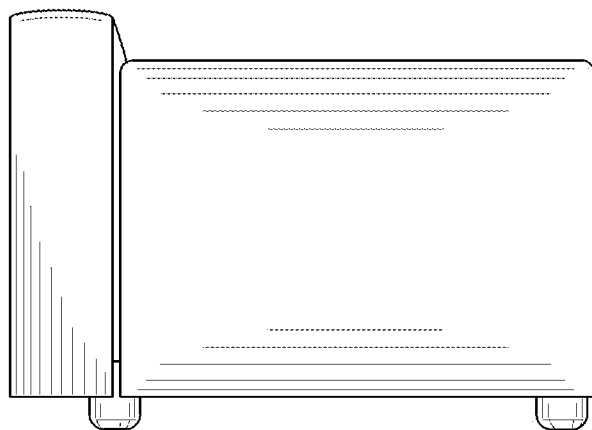

FIG. 6

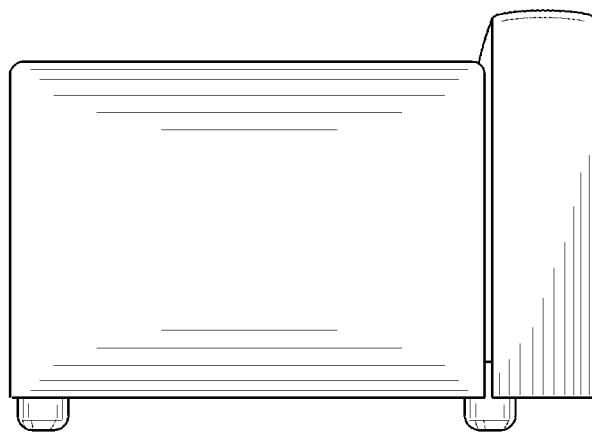

FIG. 7