



US 20140258469A1

(19) **United States**

(12) **Patent Application Publication**
Maharajh et al.

(10) **Pub. No.: US 2014/0258469 A1**

(43) **Pub. Date: Sep. 11, 2014**

(54) **CONSUMPTION PROFILE FOR MOBILE MEDIA**

(71) Applicant: **Quickplay Media Inc.**, Toronto (CA)

(72) Inventors: **Kavi Maharajh**, Oakville (CA); **Bart MacNeil**, Toronto (CA); **Torin Walker**, Oakville (CA)

(73) Assignee: **Quickplay Media Inc.**, Toronto (CA)

(21) Appl. No.: **14/153,533**

(22) Filed: **Jan. 13, 2014**

Related U.S. Application Data

(63) Continuation of application No. 11/956,138, filed on Dec. 13, 2007, now Pat. No. 8,671,021.

(60) Provisional application No. 60/889,895, filed on Feb. 14, 2007, provisional application No. 60/869,889, filed on Dec. 13, 2006.

Publication Classification

(51) **Int. Cl.**
H04L 29/08 (2006.01)

(52) **U.S. Cl.**
CPC **H04L 67/10** (2013.01)
USPC **709/219**; 709/217

(57) **ABSTRACT**

In embodiments, the present invention provides a method and system for delivery of content on a mobile media platform, providing a consumption profile, and delivering content to a mobile device, wherein content delivery is based at least in part on the consumption profile. Further, in embodiments, the present invention provides a consumption profile for a mobile media platform comprising a device profile, a user profile, a network profile, an encoding profile, and a content profile.

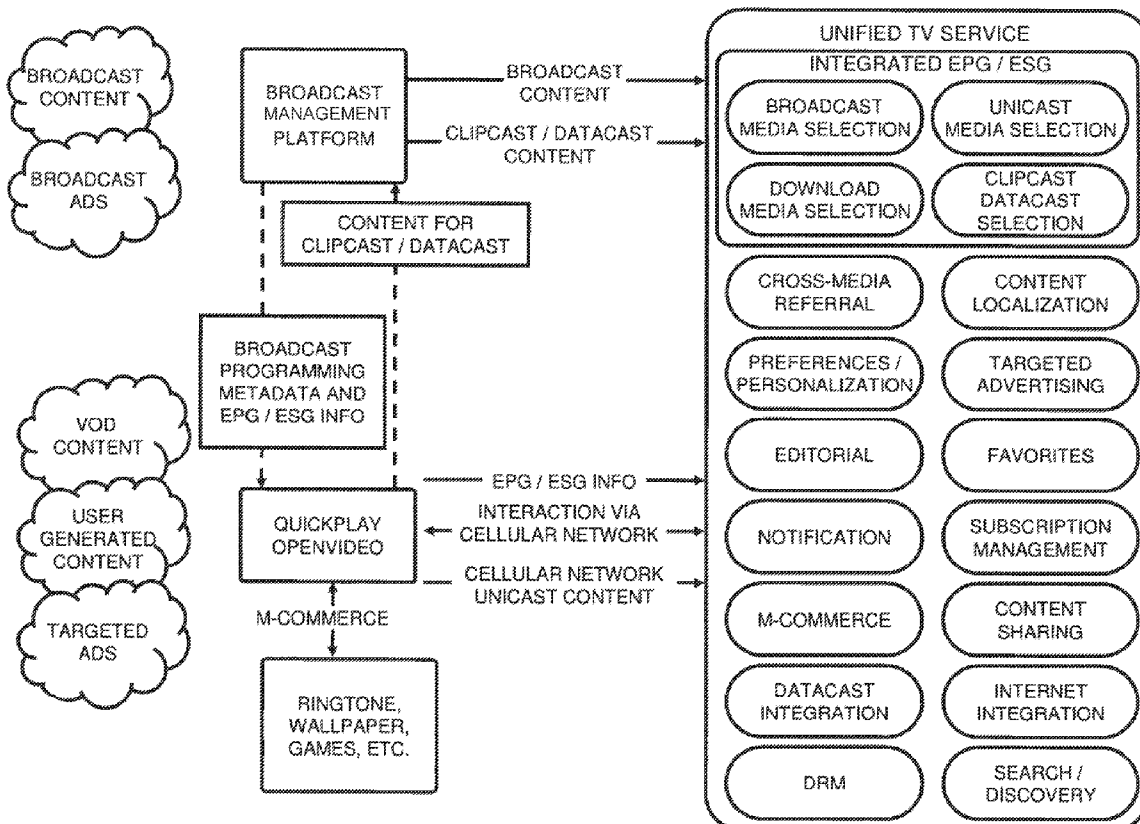

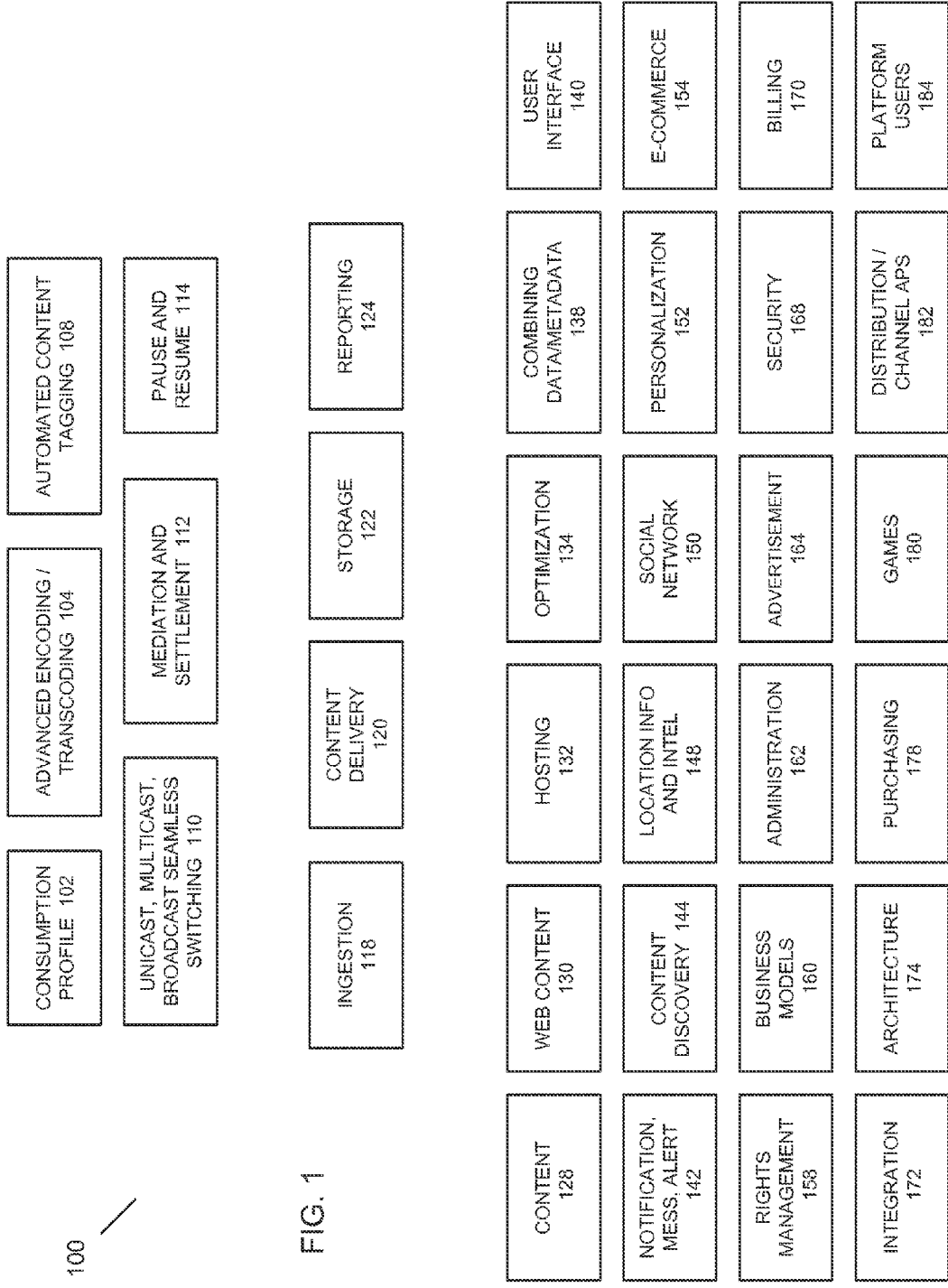

FIG. 1

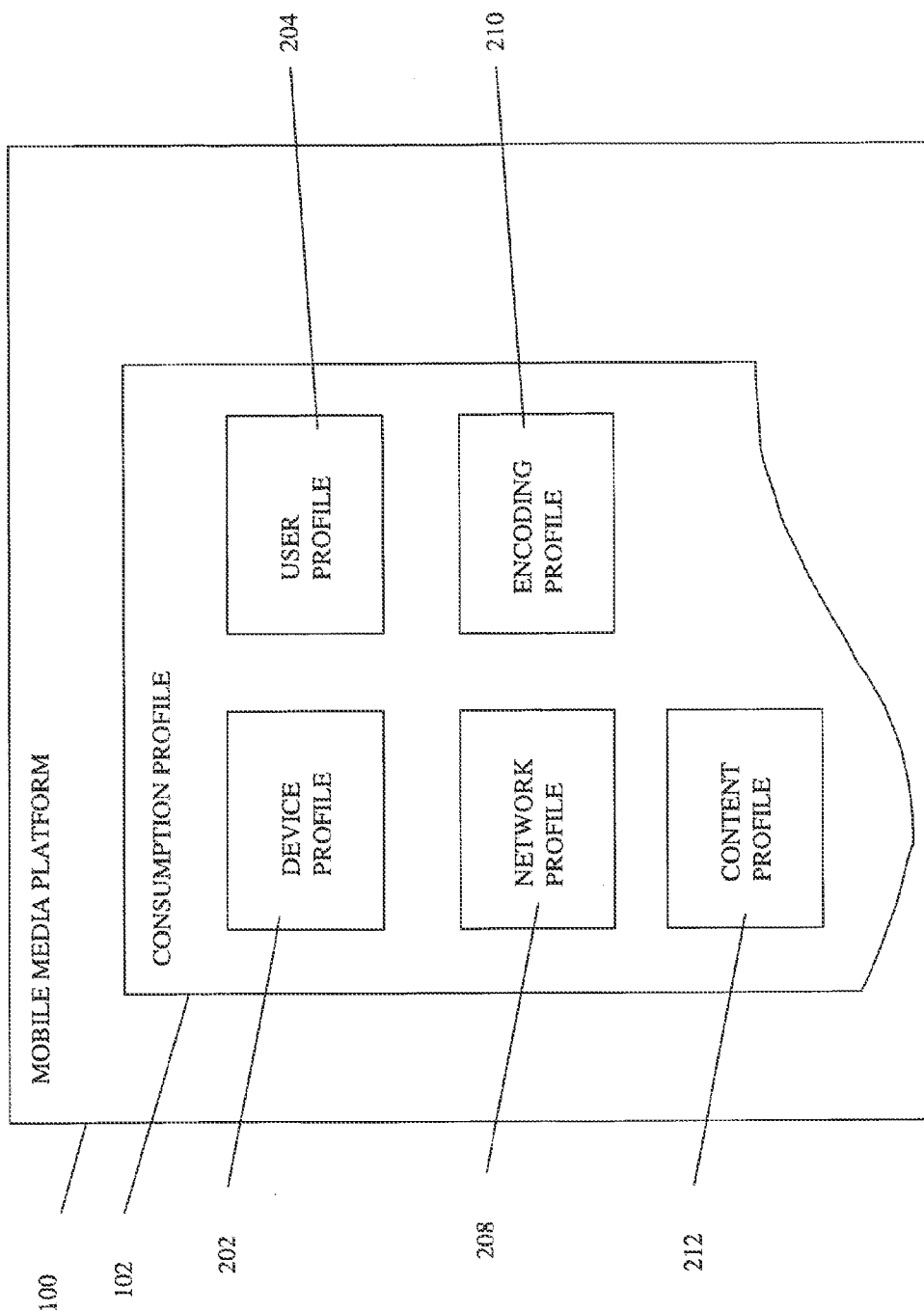

Fig. 2

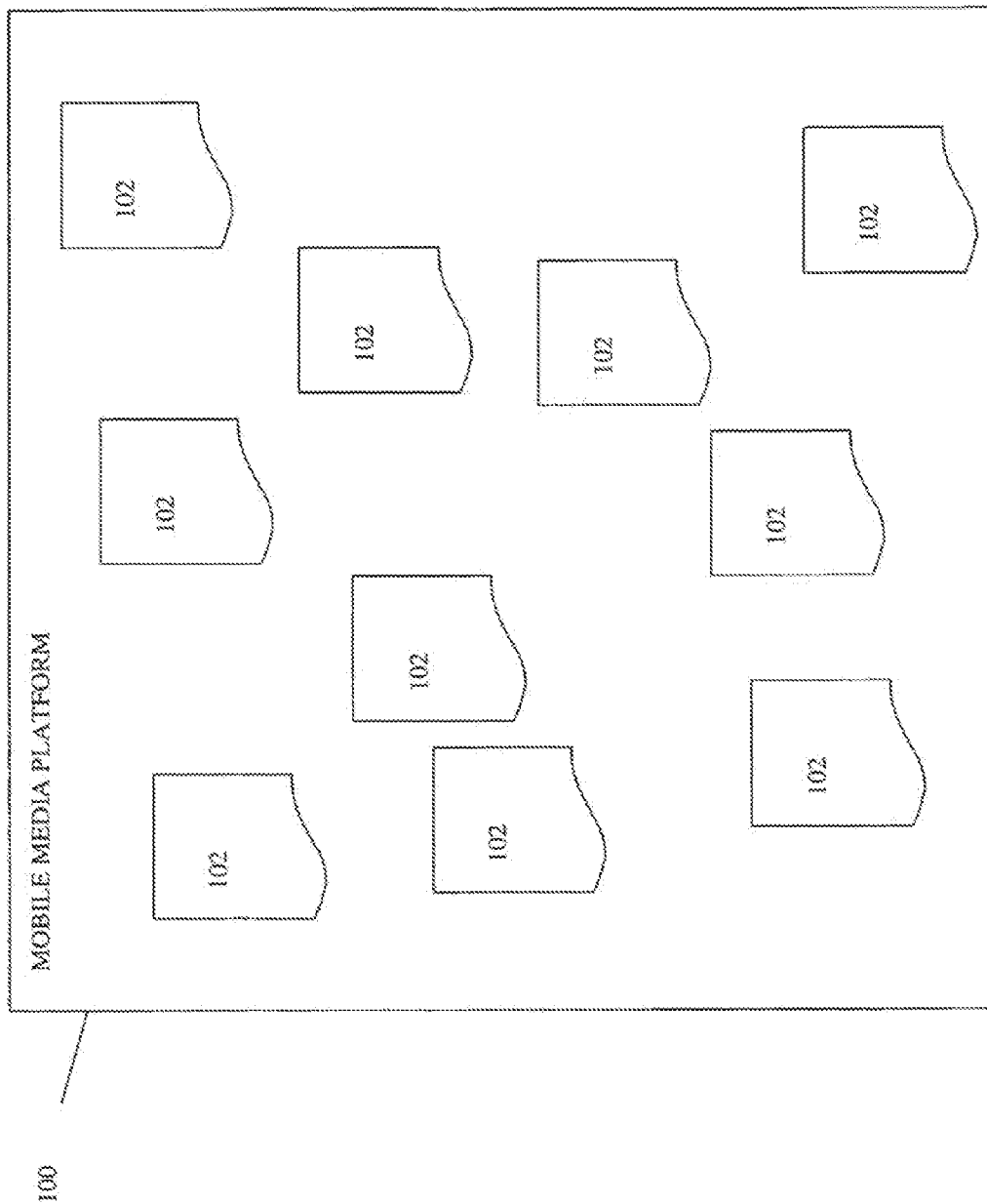

Fig. 3

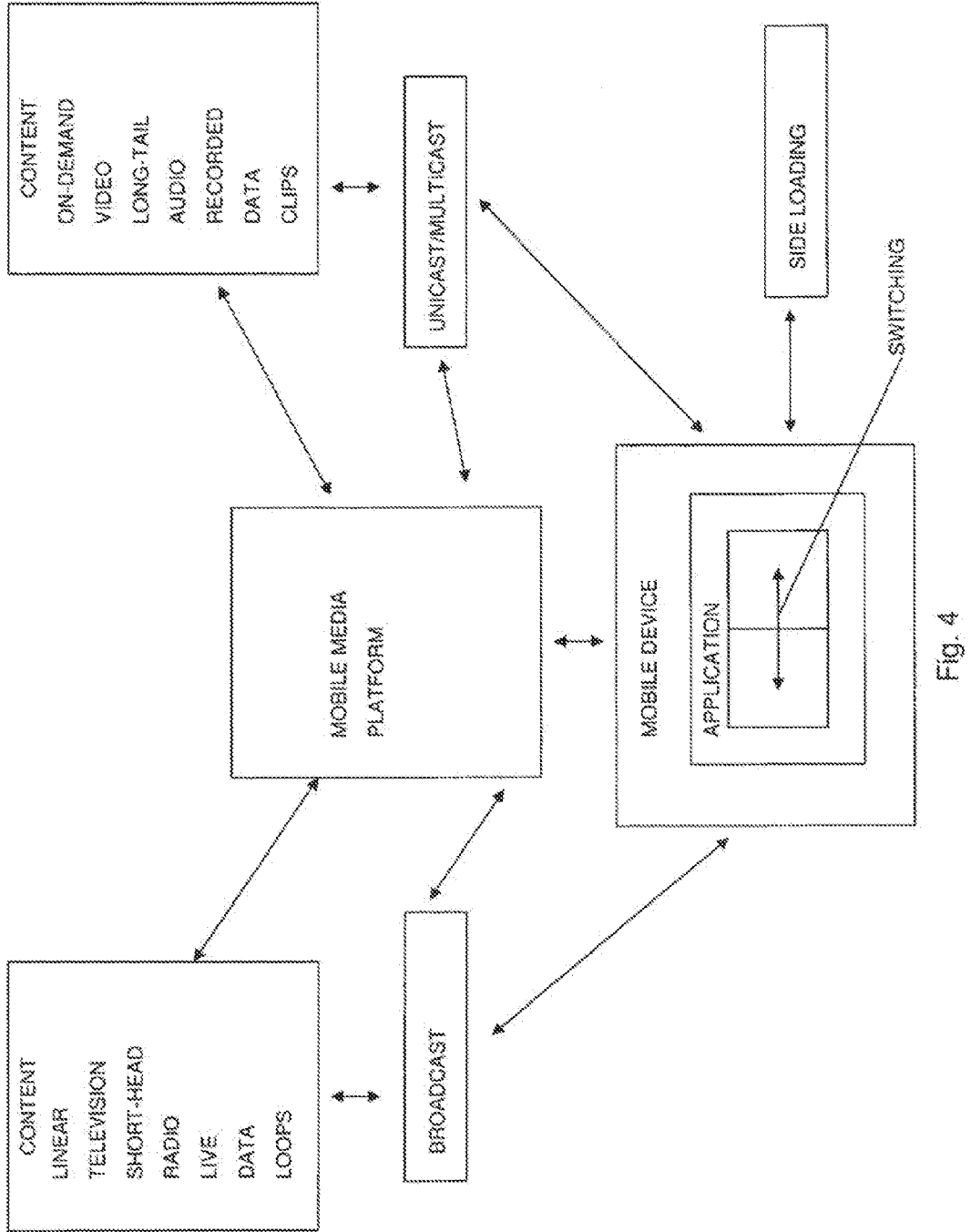

Fig. 4

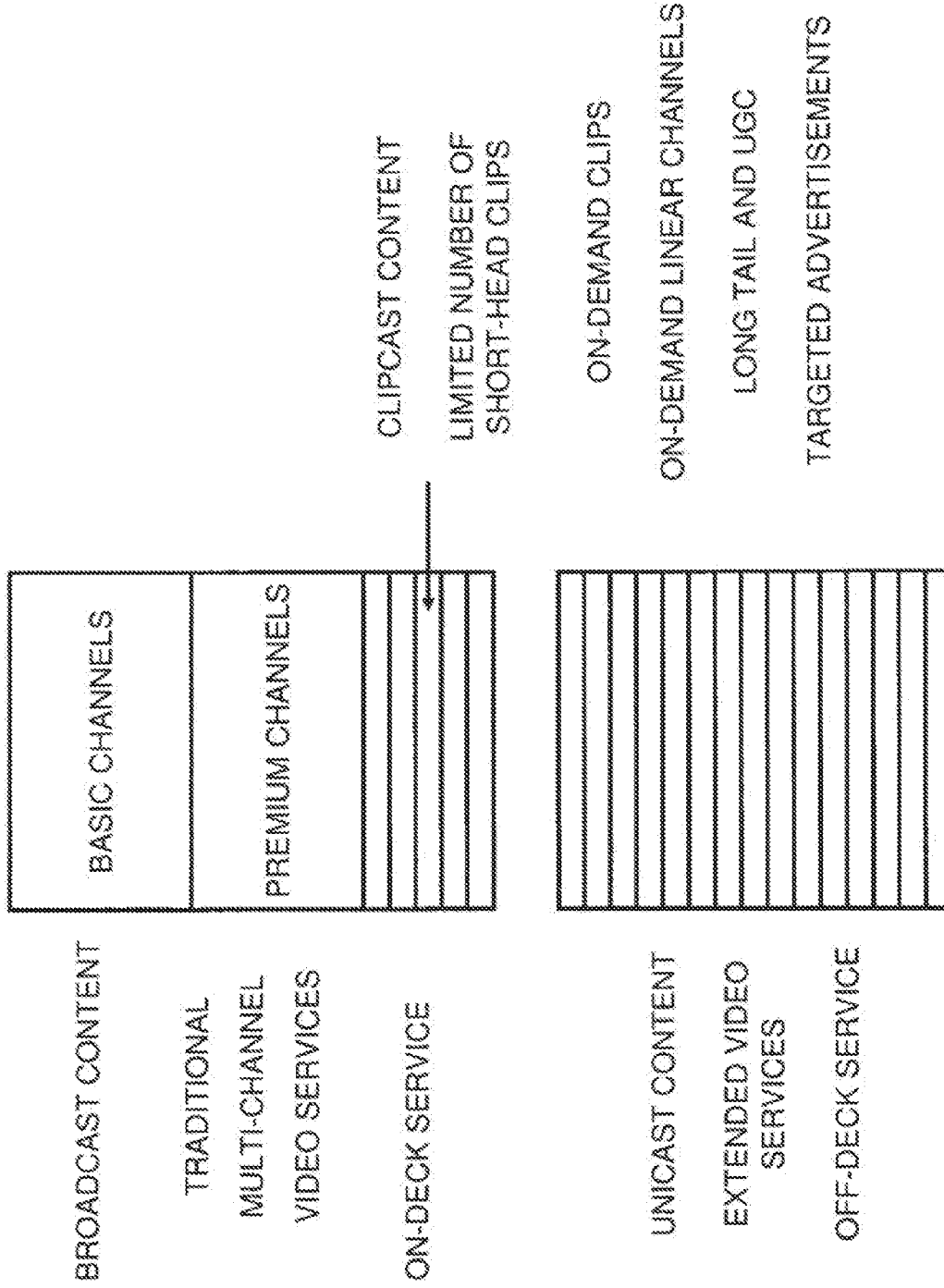

Fig. 5

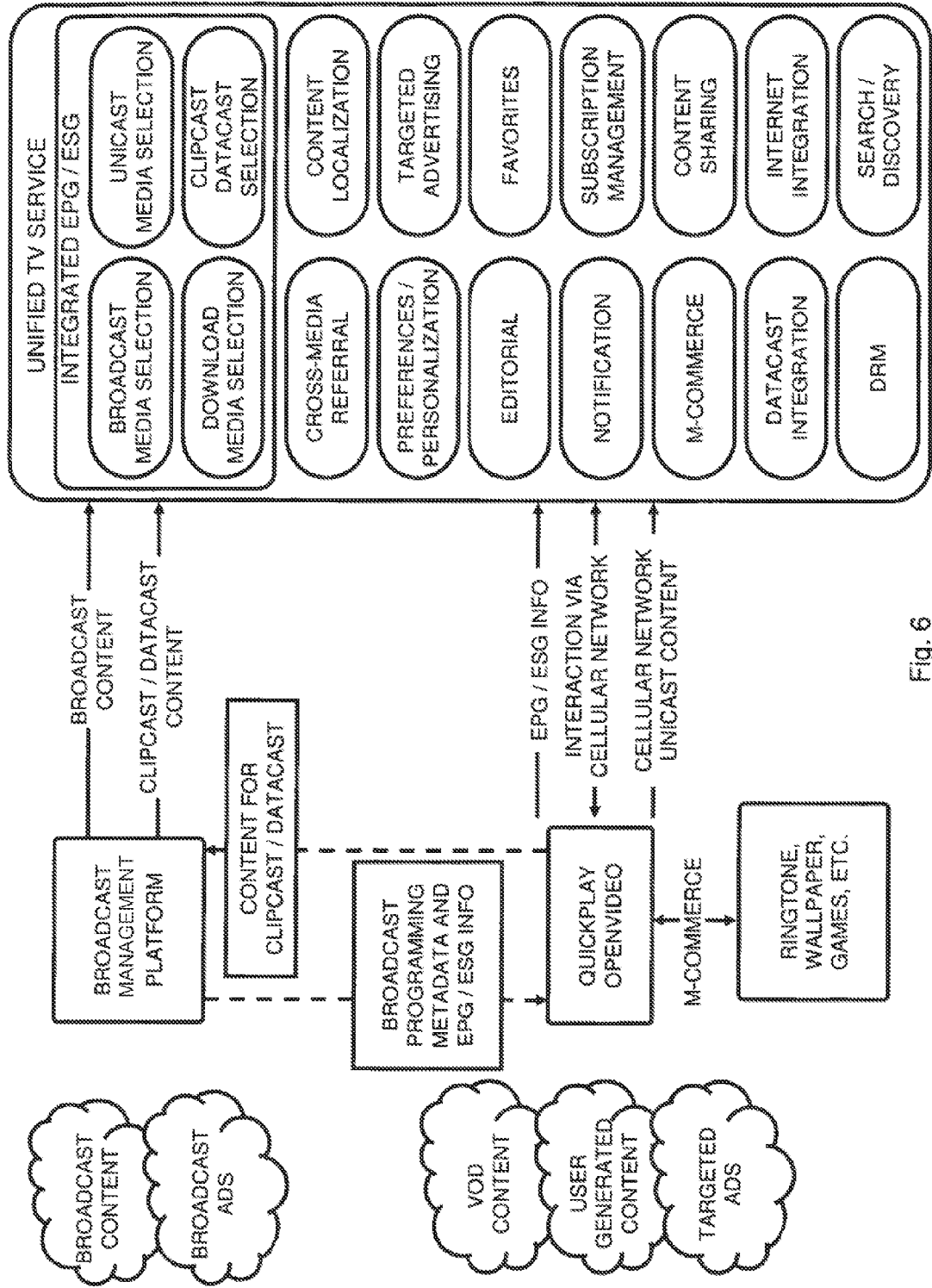

Fig. 6

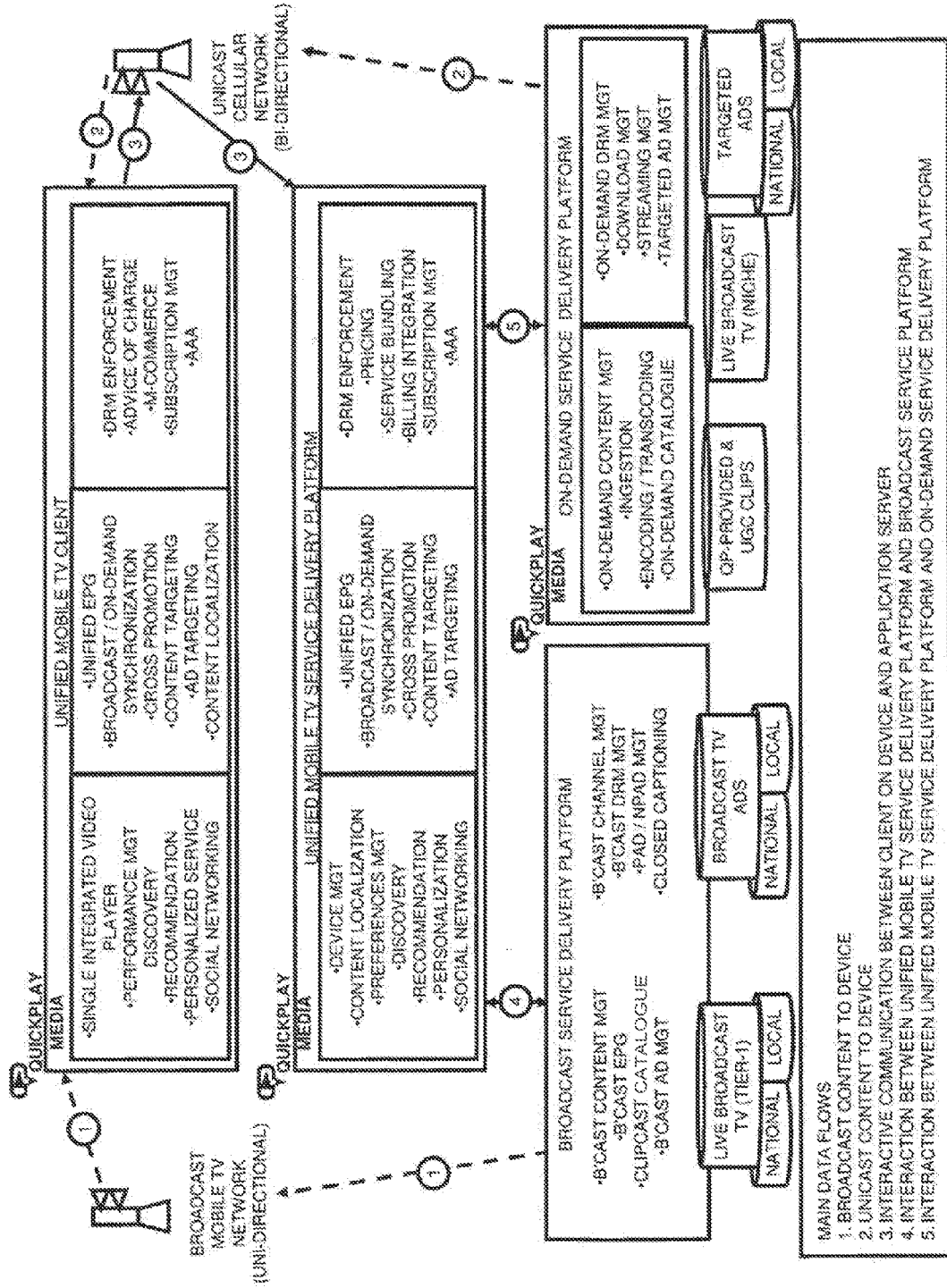

Fig. 7

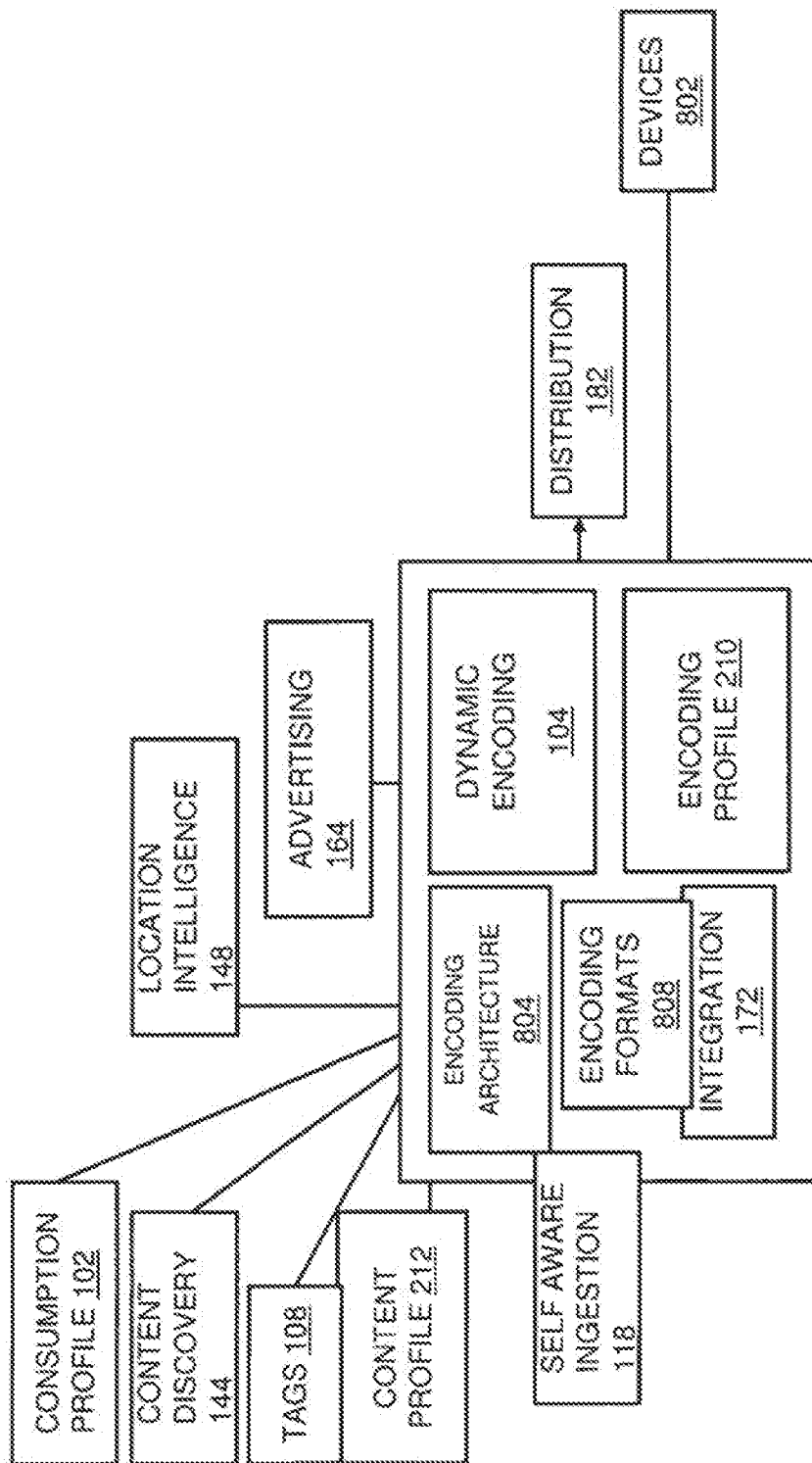

Fig. 8

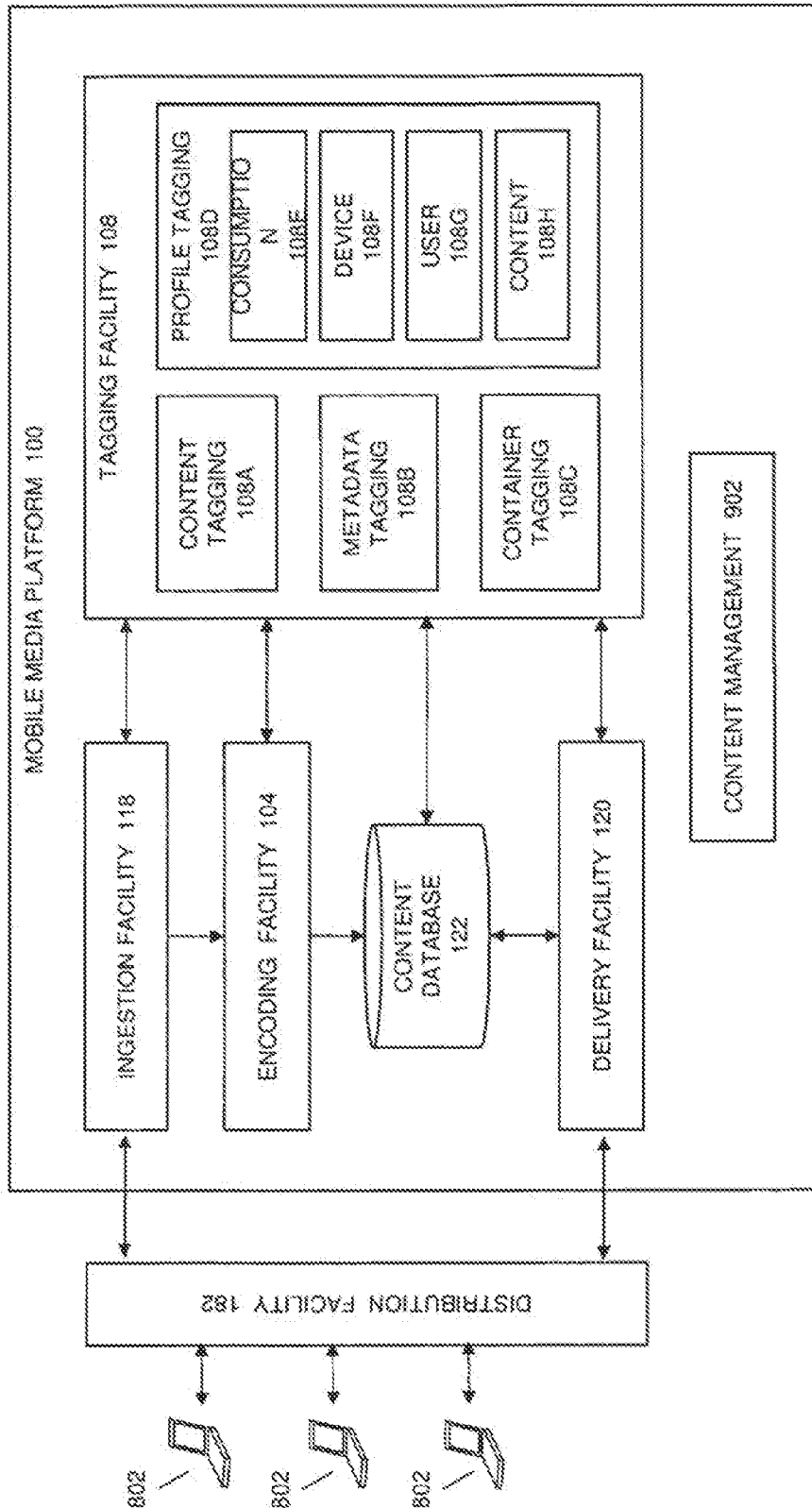

Fig. 9

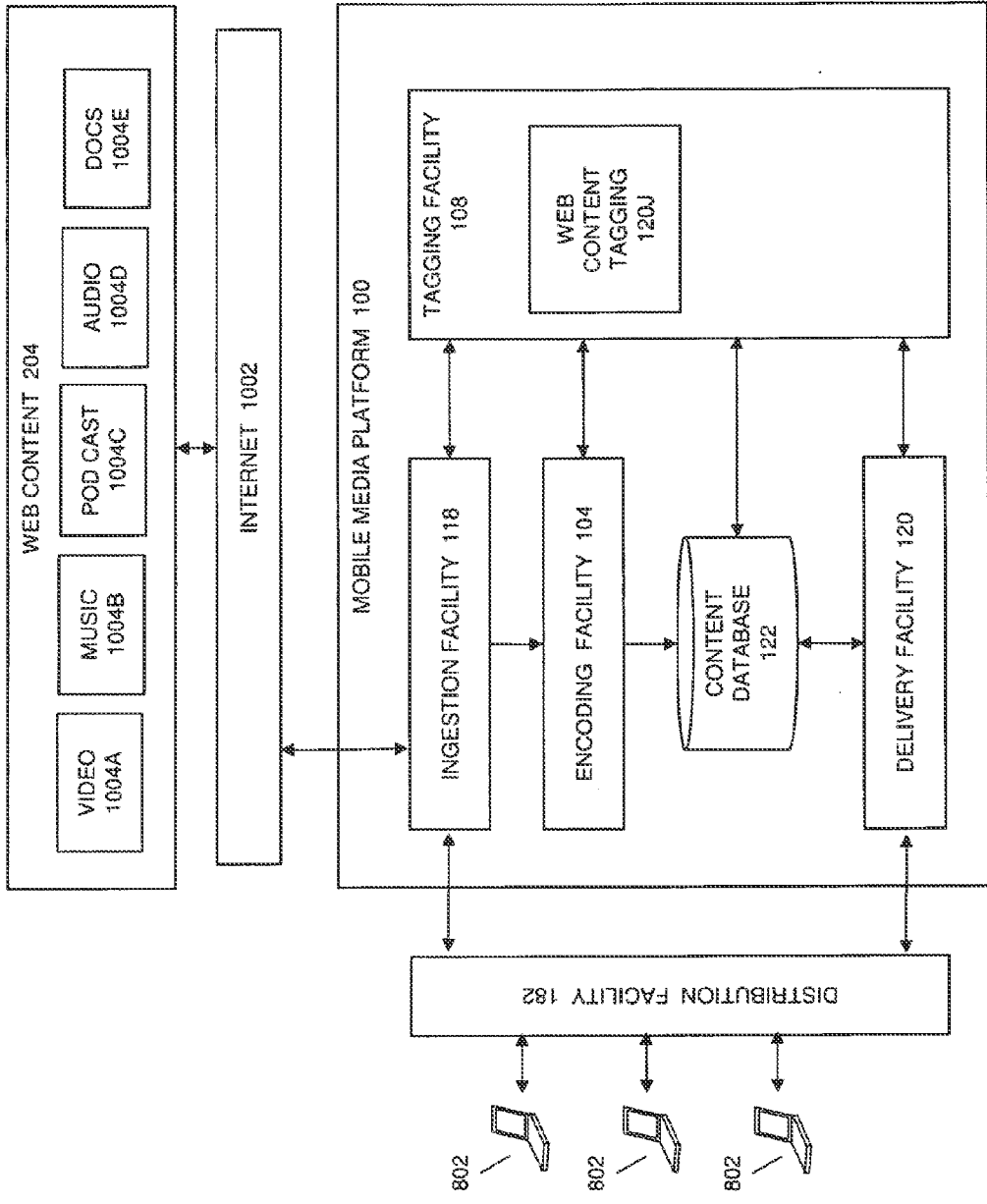

Fig. 10

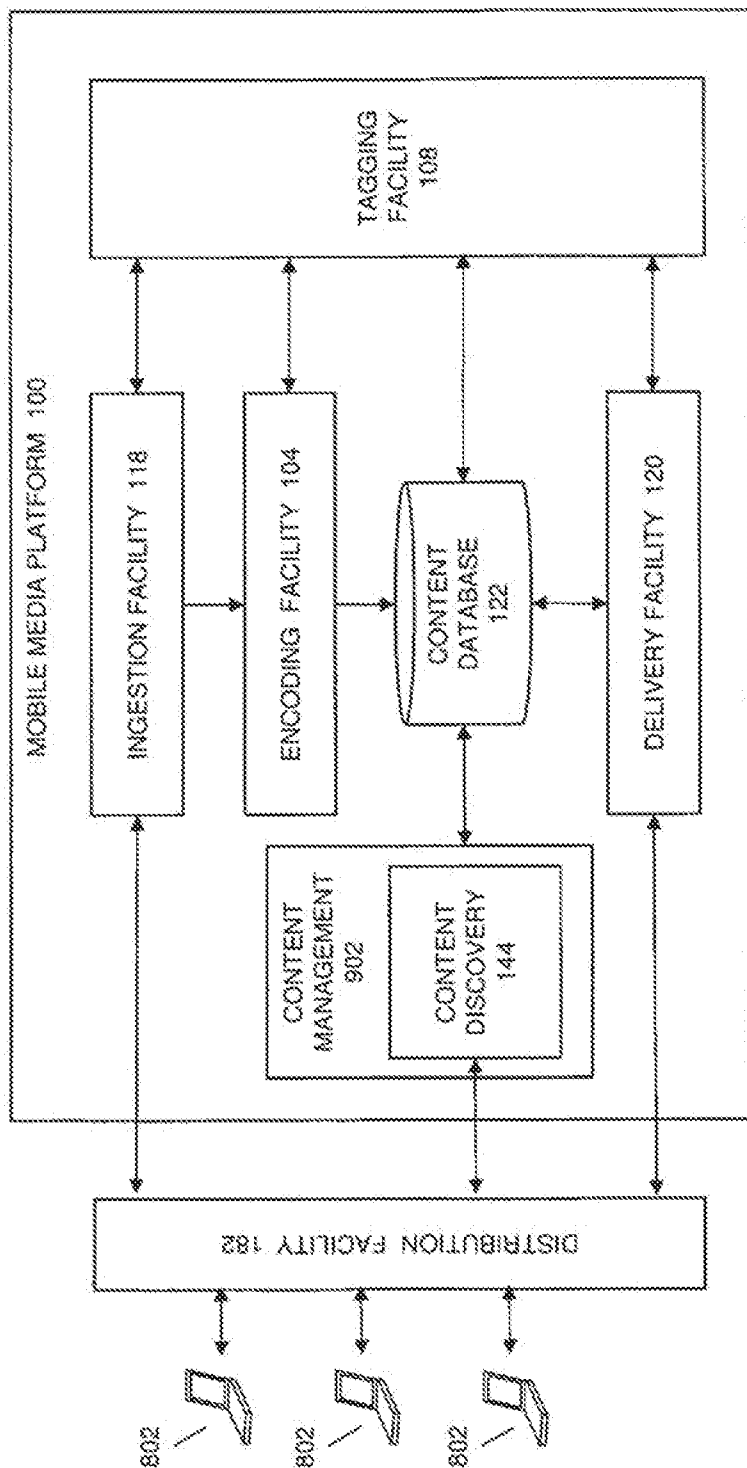

Fig. 11

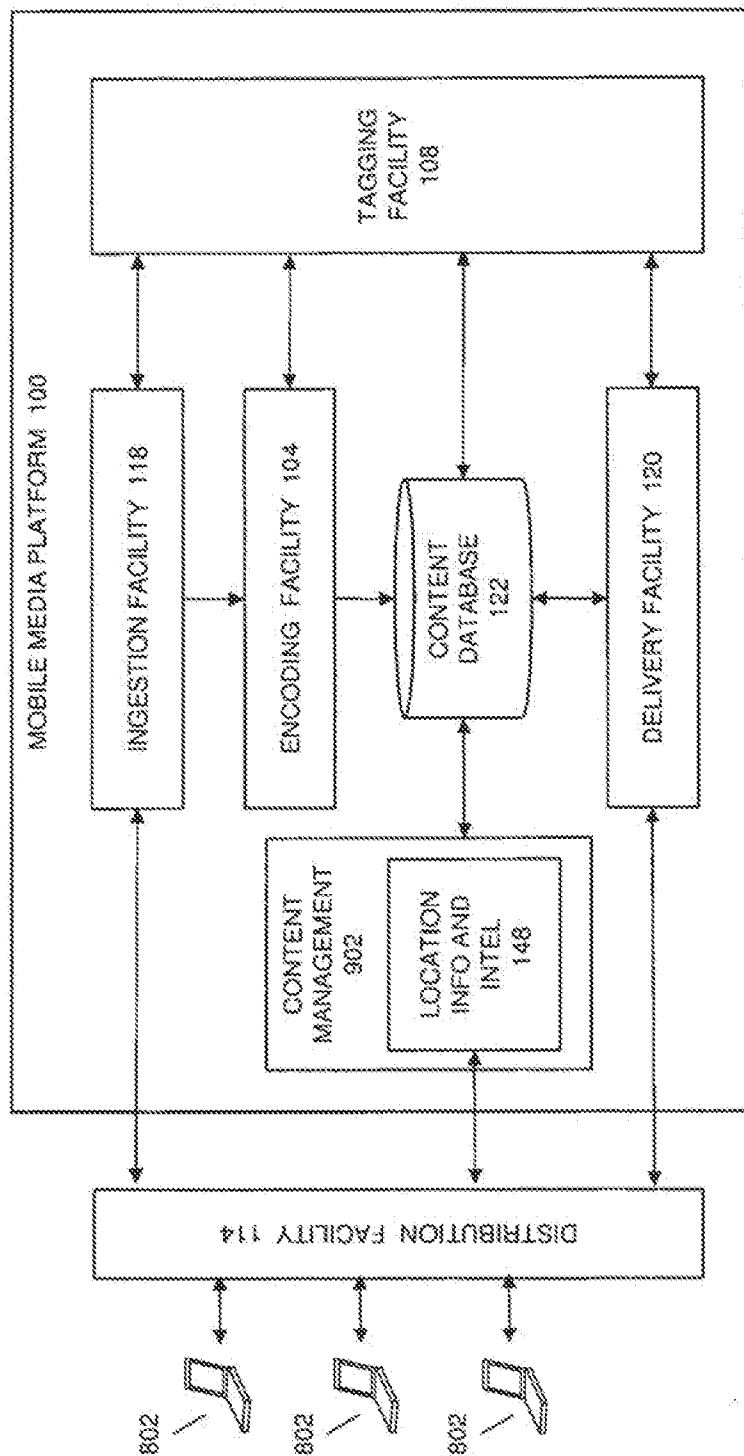

Fig. 12

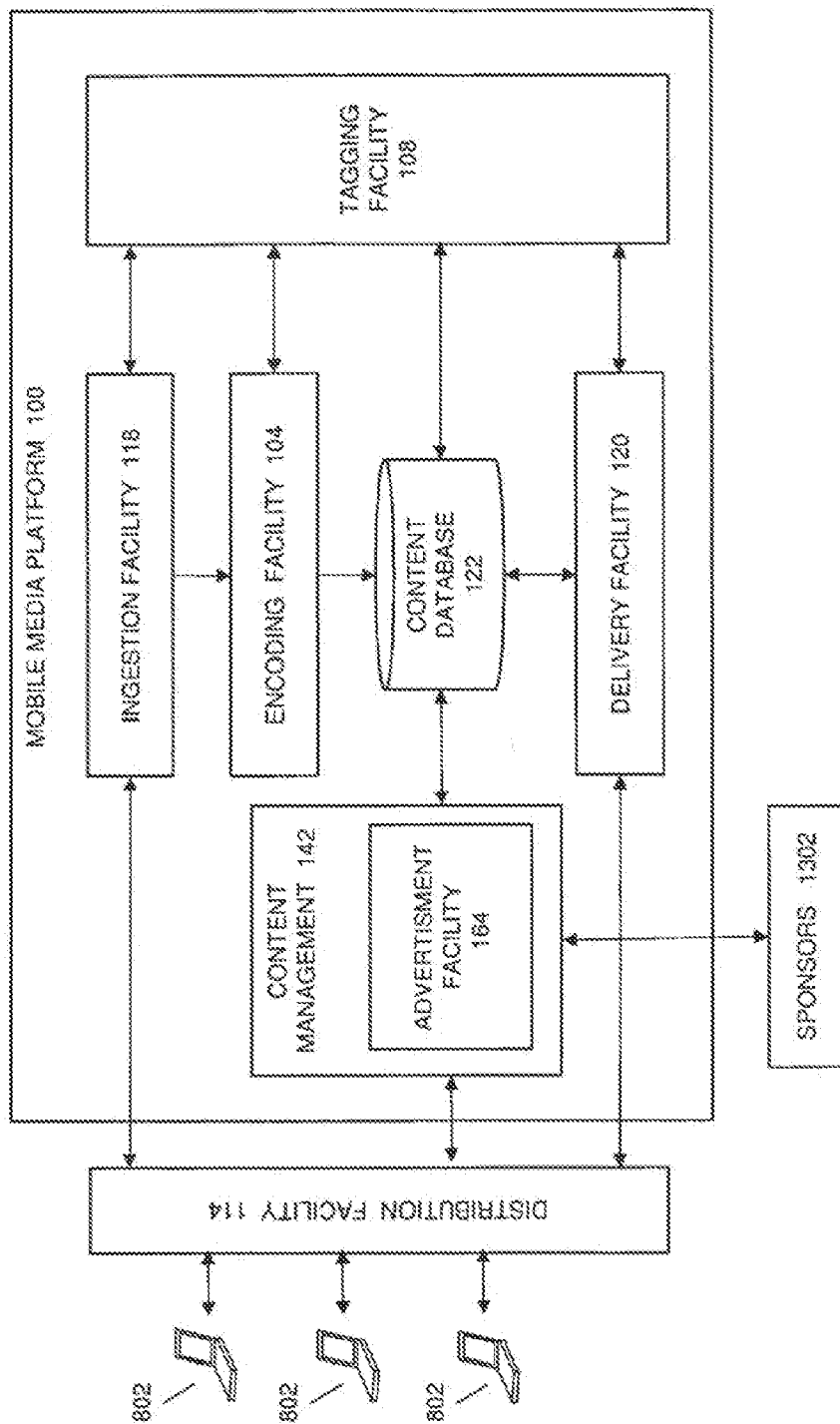

Fig. 13

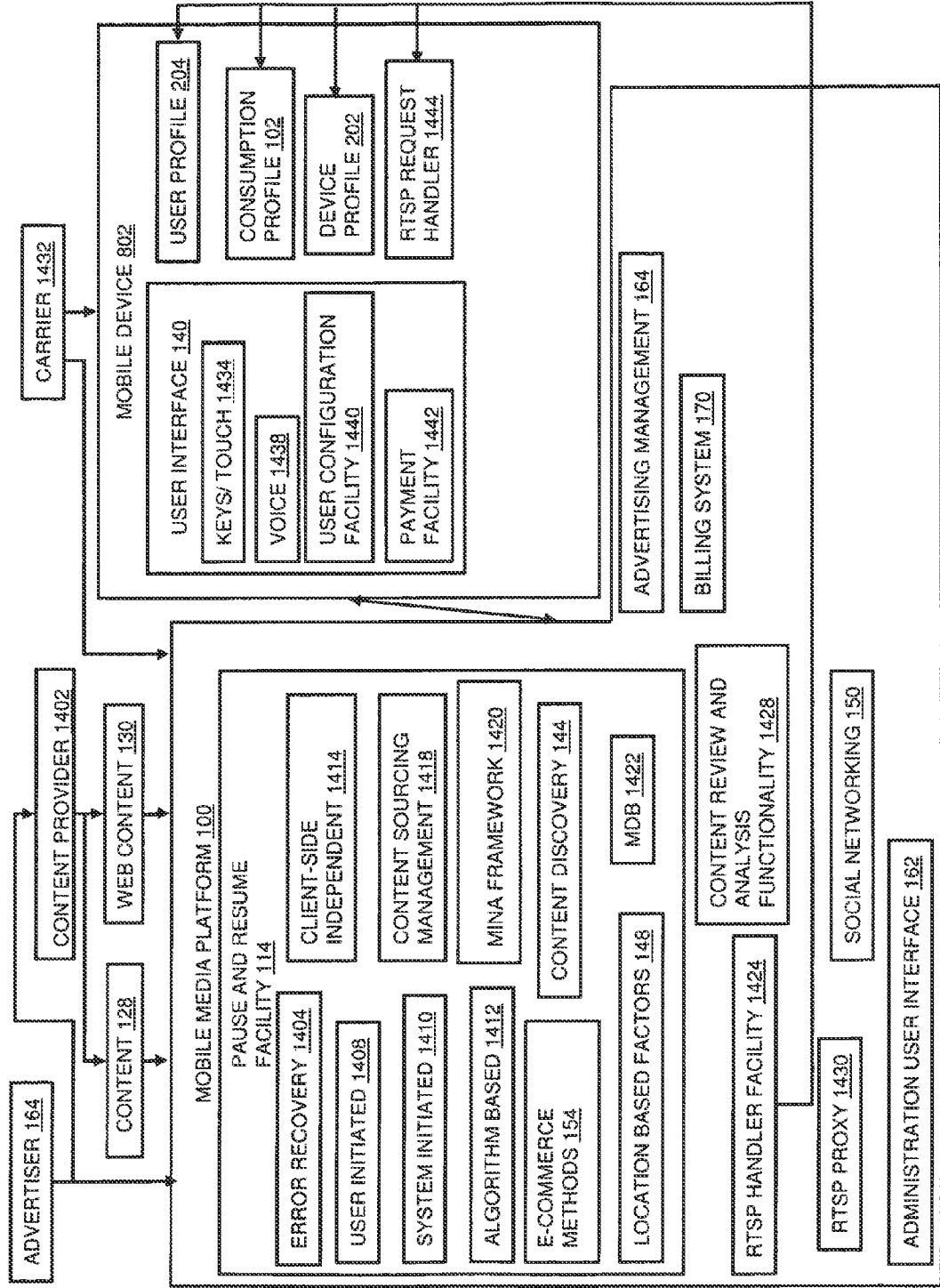
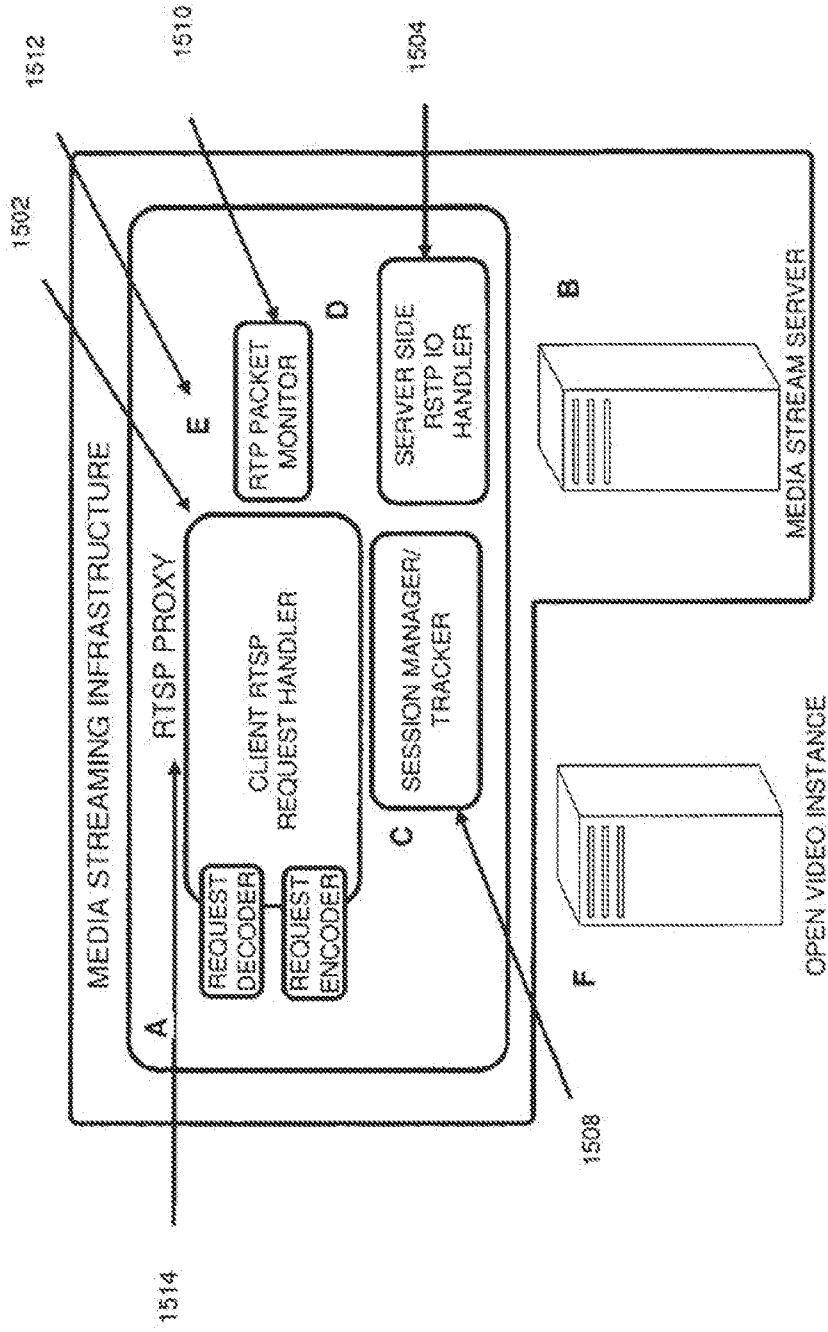

Fig. 14



- A. CLIENT RTPSP REQUEST HANDLER
- B. SERVER SIDE RTPSP IO HANDLER
- C. SESSION TRACKER/MONITOR MAINTAINS
- D. RTP PACKET MONITOR
- E. EMBEDDED DERBY

Fig. 15

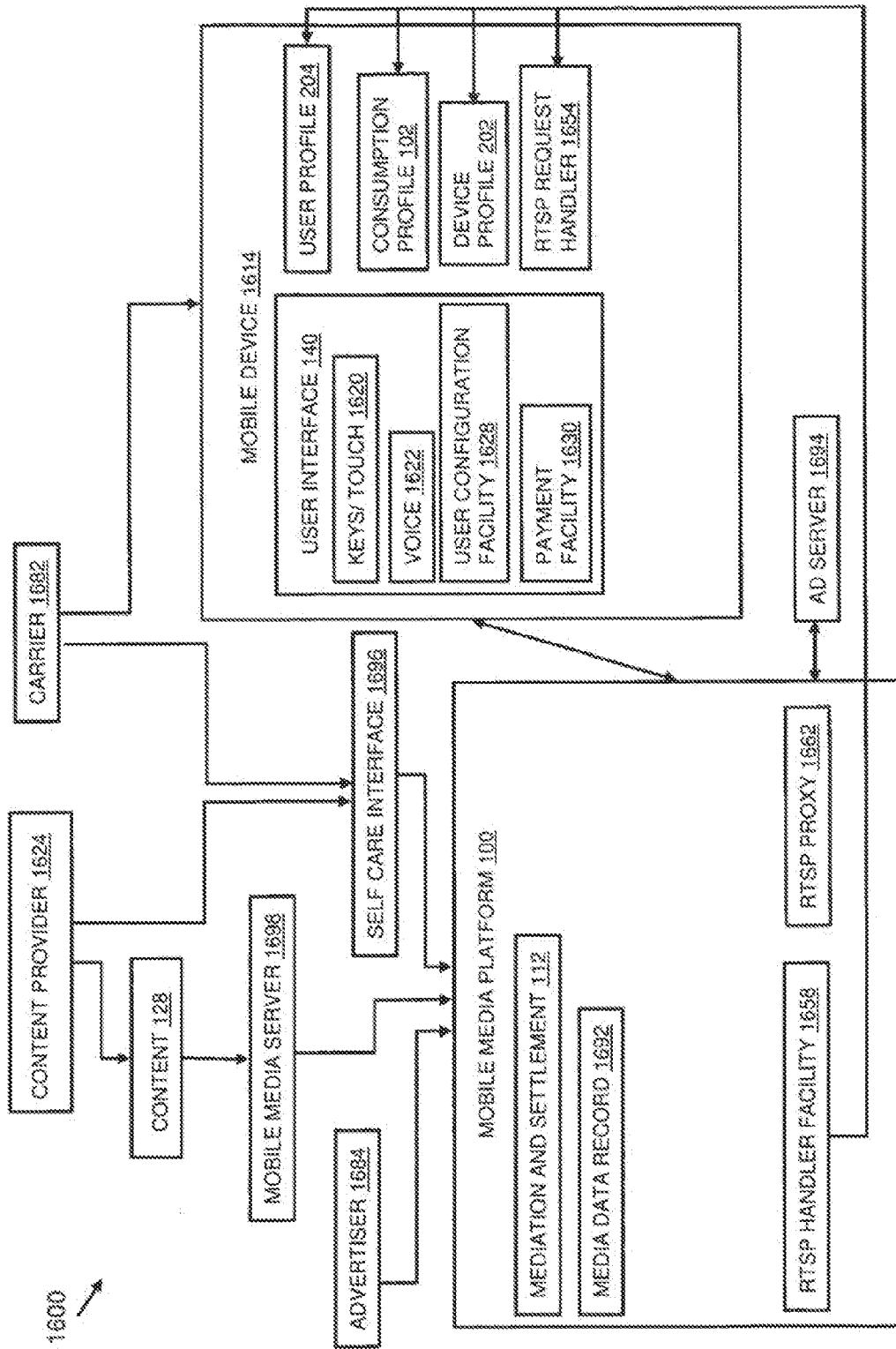

Fig. 16

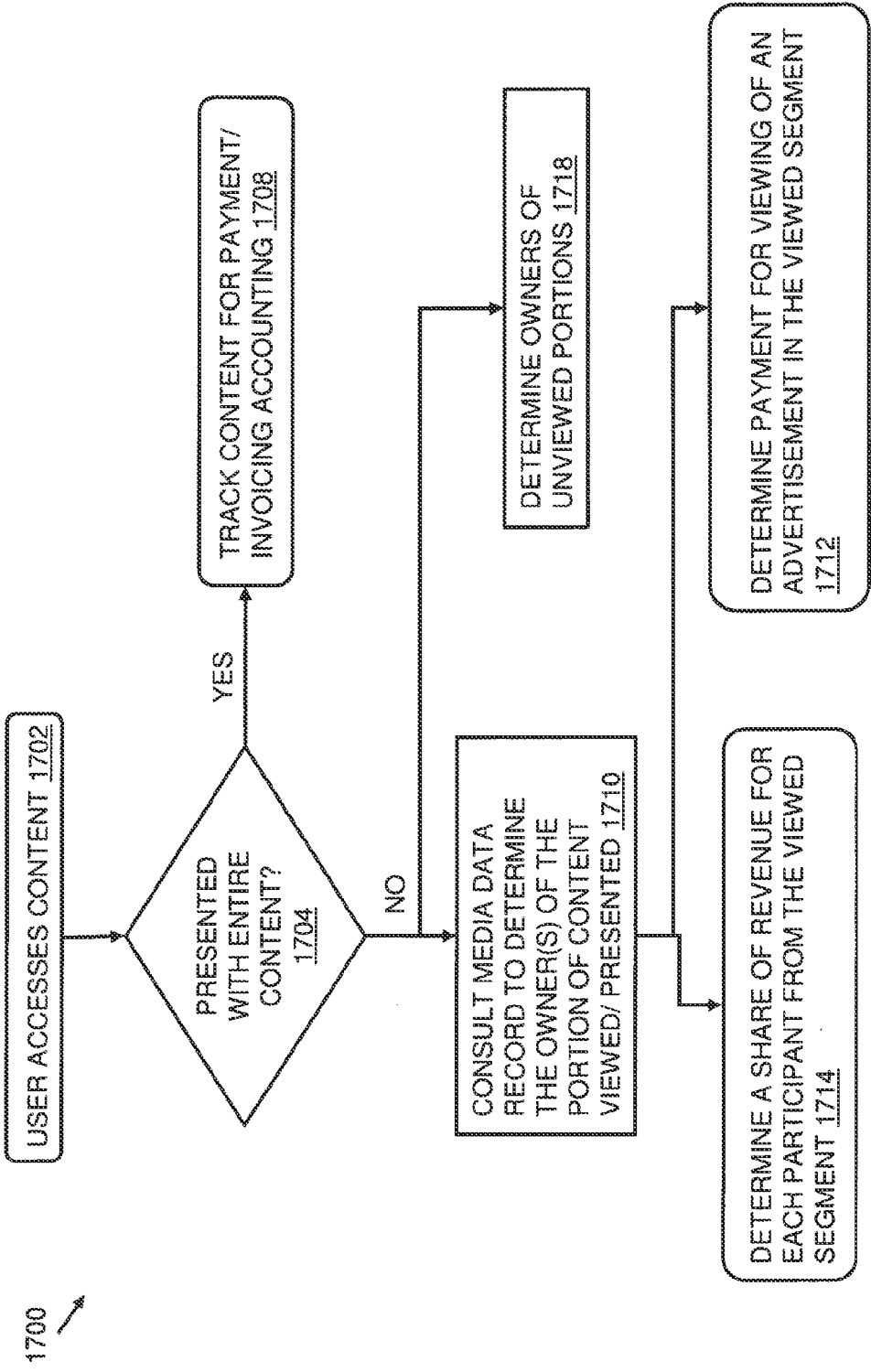

Fig. 17

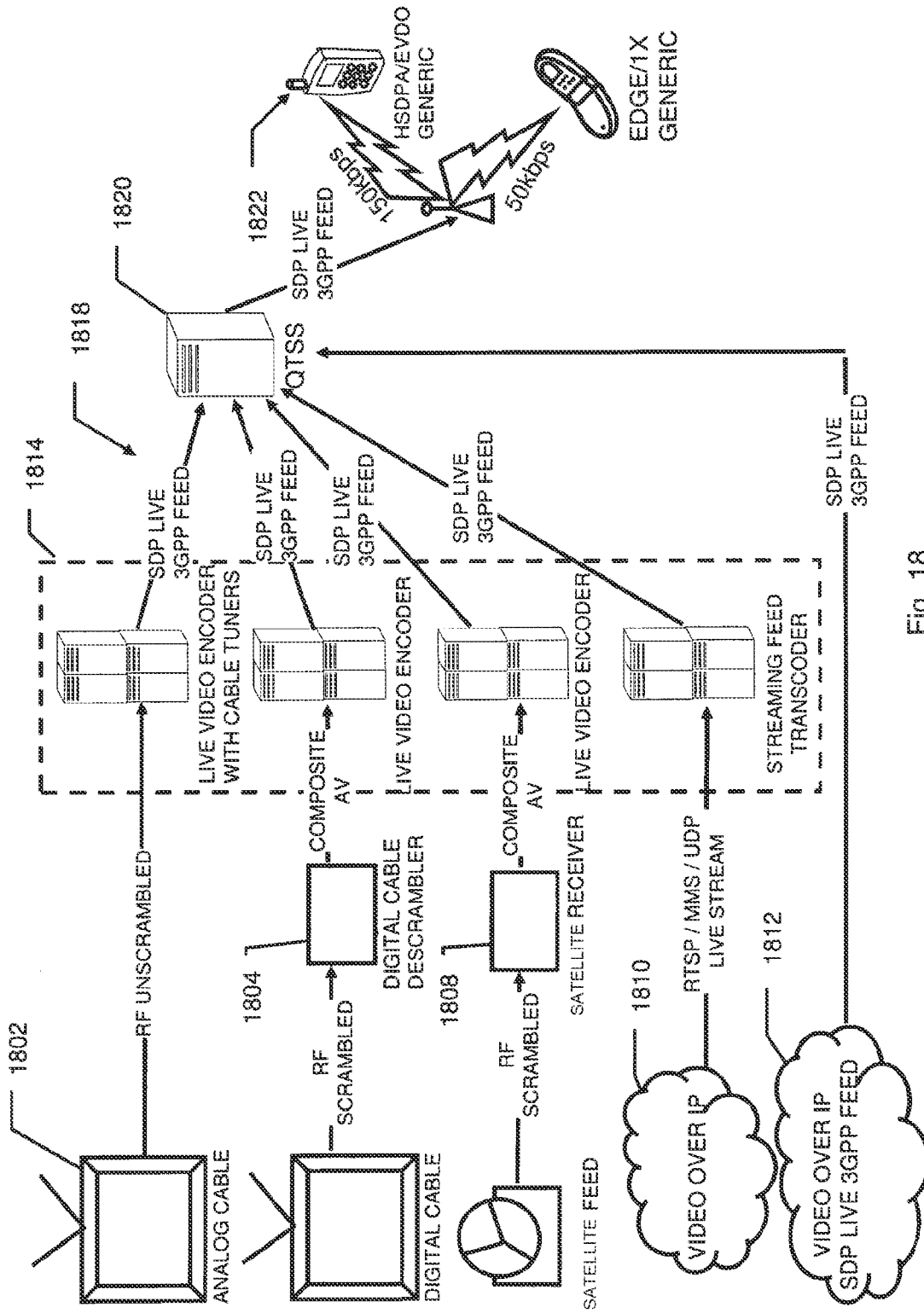

Fig. 18

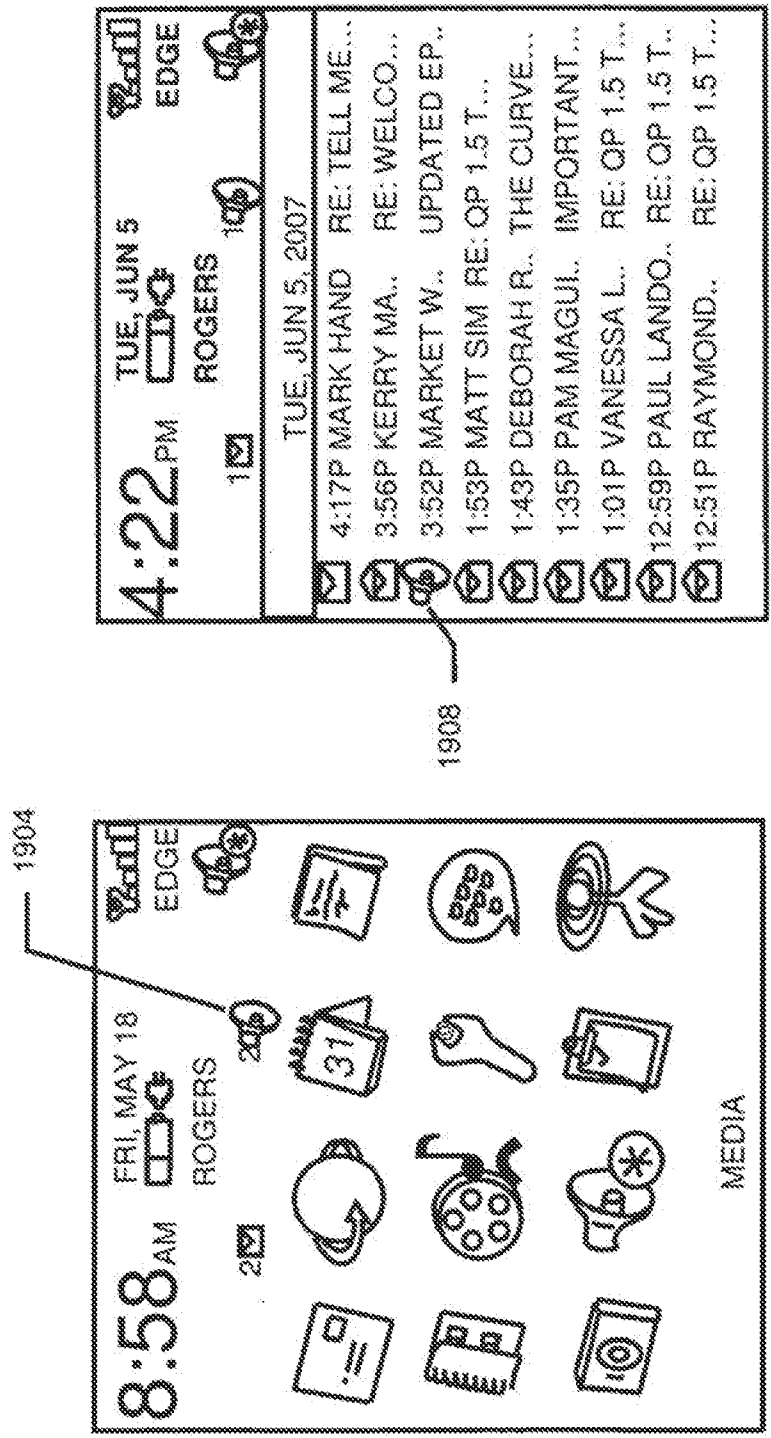

Fig. 19

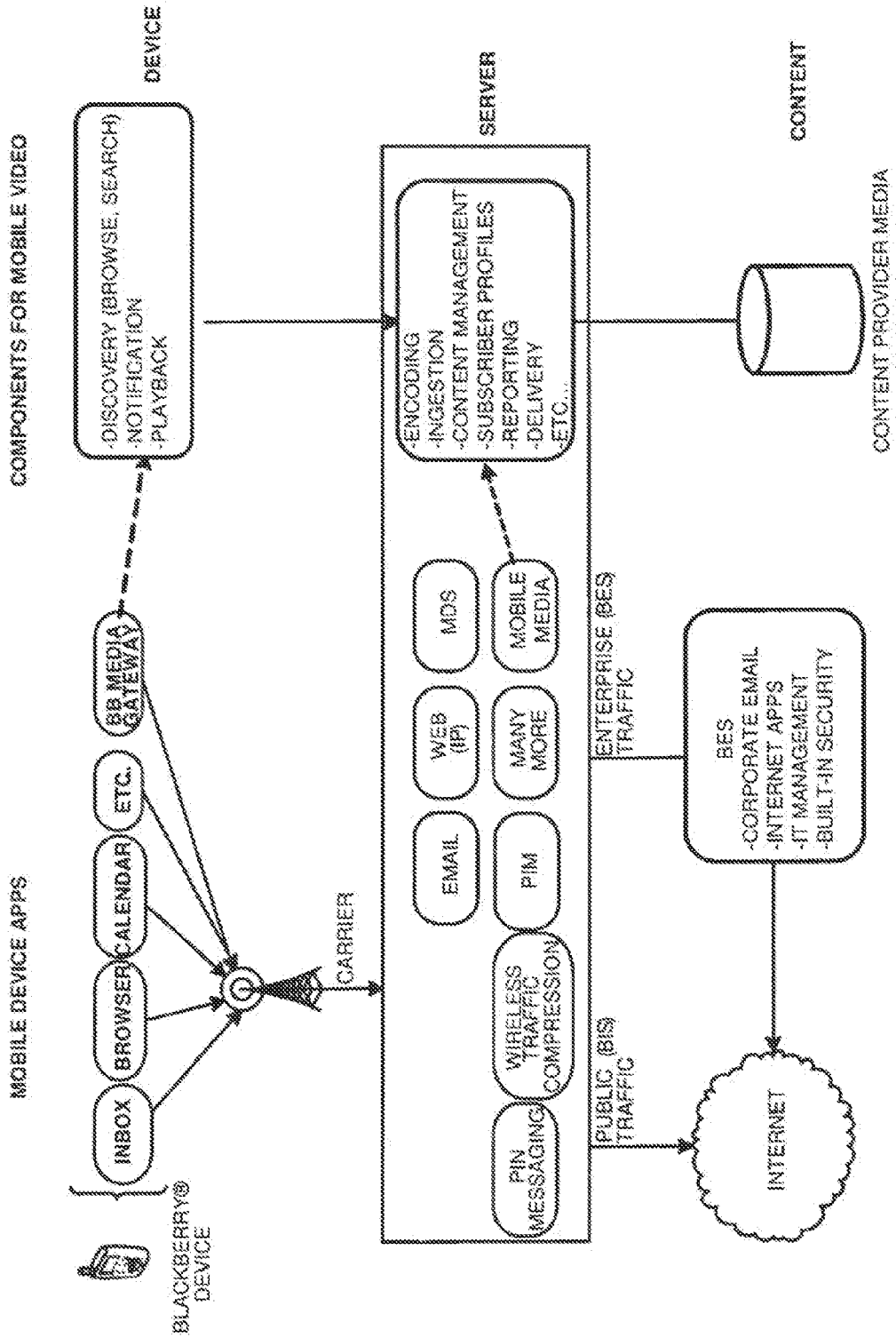



Fig. 20



QUICKPLAY MEDIA

LOGOUT

OPENVIDEO ADMINISTRATION

INGESTION

DASHBOARD

PROVIDERS

CONTENT

REPORTS

CONTENT - VIEW CATEGORY

- [-] UserContenterAnything
 - [-] Lab_Trial
 - [-] CNN
 - [-] CNN_Business**
 - [-] CNN_Entertainment
 - [-] CNN_NewsIntheNews
 - [-] CNN_US
 - [-] CNN_Politics
 - [-] CNN_World
 - [-] CNN_Other

RETURN TO CONTENT HOME

CATEGORY DETAILS

RE-ORDER CONTENT

PATH: Sprint Lab | CNN | CNN_Business

Title	Content Provider	Meta ID	Expiry Date	Publish Date	Type	Status
Yellow world market...	CNN	21	12-07-07 21:00	12-05-07 21:57	🔍	ACTIVE
The price of expe...	CNN	26	12-07-07 23:15	12-06-07 08:00	🔍	ACTIVE
U.S. mortgage crisi...	CNN	103	12-08-07 02:30	12-06-07 03:20	🔍	ACTIVE
Business bulletin	CNN	115	12-08-07 16:15	12-06-07 17:06	🔍	ACTIVE
Preaching 'green'	CNN	127	12-08-07 16:15	12-06-07 17:09	🔍	ACTIVE
Easing the credit cr...	CNN	131	12-08-07 19:45	12-06-07 20:41	🔍	ACTIVE
Helping the Araba...	CNN	133	12-08-07 21:45	12-06-07 22:35	🔍	ACTIVE
Rice prices could do...	CNN	134	12-08-07 23:15	12-07-07 00:00	🔍	ACTIVE
Bank of England dis...	CNN	143	12-09-07 04:45	12-07-07 05:41	🔍	ACTIVE
Inside a mortgage fi...	CNN	150	12-09-07 07:00	12-07-07 07:50	🔍	ACTIVE

SELECT FILTER

CLEAR FILTER

CONTENT ACTIONS

CHANGE DATES

MOVE OR COPY

REMOVE

20 items found, displaying 1 to 10. [first/prev] 1, 2 [next/last]

Fig. 21

QUICKPLAY MEDIA 

HELLO PETER COOPER [LOGOUT](#)
[VIEW YOUR ACCOUNT](#)

OPENVIDEO ADMINISTRATION

[DASHBOARD](#) [REPORTS](#) [BRANDING](#) [HELP](#)

[RETURN TO REPORTS HOME](#)

Standard Reports

The Content Store was last updated on Dec 6th, 2007

GENERATE REPORT

REPORT:

FORMAT:

FILTER BY DATE RANGE: FROM: TO:

FILTER BY DELIVERY METHOD: INCLUDE STREAMING DATA
 INCLUDE DOWNLOAD DATA

[GENERATE REPORT](#)

Fig. 22



QUICKPLAY MEDIA

LOGOUT

OPENVIDEO ADMINISTRATION

INGESTION

DASHBOARD

PROVIDERS

CONTENT

REPORTS

SCHEDULER

JOB QUEUE

LISTENERS

COMPONENTS

PROFILES

Schedule Management

The time is presently: 2007-12-07 05:21:15

The scheduler is in RUNNING mode. PAUSE SCHEDULER

Schedule Name	Description	State	Component	Next Execution Time
crin	every 15 minutes Active	CNN	RSSCollector	2007-12-07 05:30:00

CREATE NEW SCHEDULED JOB

Fig. 23

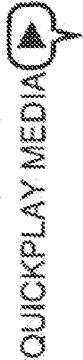

QUICKPLAY MEDIA

LOGOUT

OPENVIDEO ADMINISTRATION

INGESTION

DASHBOARD

PROVIDERS

CONTENT

REPORTS

SCHEDULER

JOB QUEUE

LISTENERS

COMPONENTS

PROFILES

Components

Component Name	Description	Module	Profile
LabTrial_Collector	RSS Collector - Collects files from RSS feeds	RSSCollector	LabTrial_RSS_Collector
LabTrial_EncodeToAVI	Encode content to AVI format	GenericEncoder	LabTrial_EncodeToAVIProfile
LabTrial_AVtoMP4	Encode AVI to MP4	GenericMP4Encoder	LabTrial_AVtoMP4Profile
LabTrial_Publisher	Publish Content	SimplePublisherModule	LabTrial_PublisherProfile
CNN_RSSCollector	CNN RSSCollector	RSSCollector	CNN_RSSCollectorProfile
CNN_AVtoHSDPA144	CNN_AVtoHSDPA144	GenericMP4Encoder	CNN_AVtoHSDPA
CNN_MP4toAVI	CNN_MP4toAVI	GenericEncoder	CNN_MP4toAVI
CNNPublisher	CNNPublisher	SimplePublisherModule	CNNPublisher

CREATE NEW COMPONENT

Fig. 24.

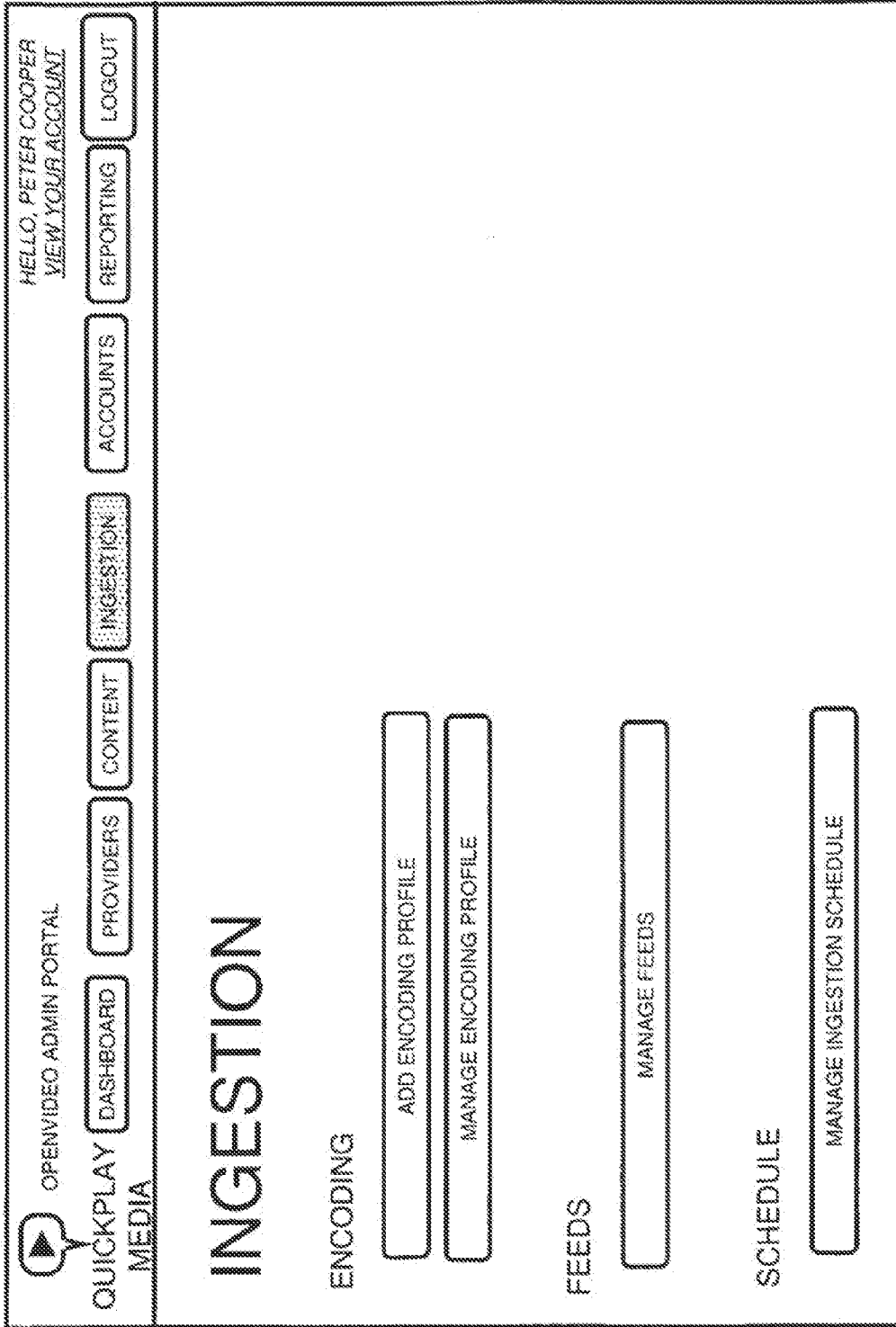

Fig. 25

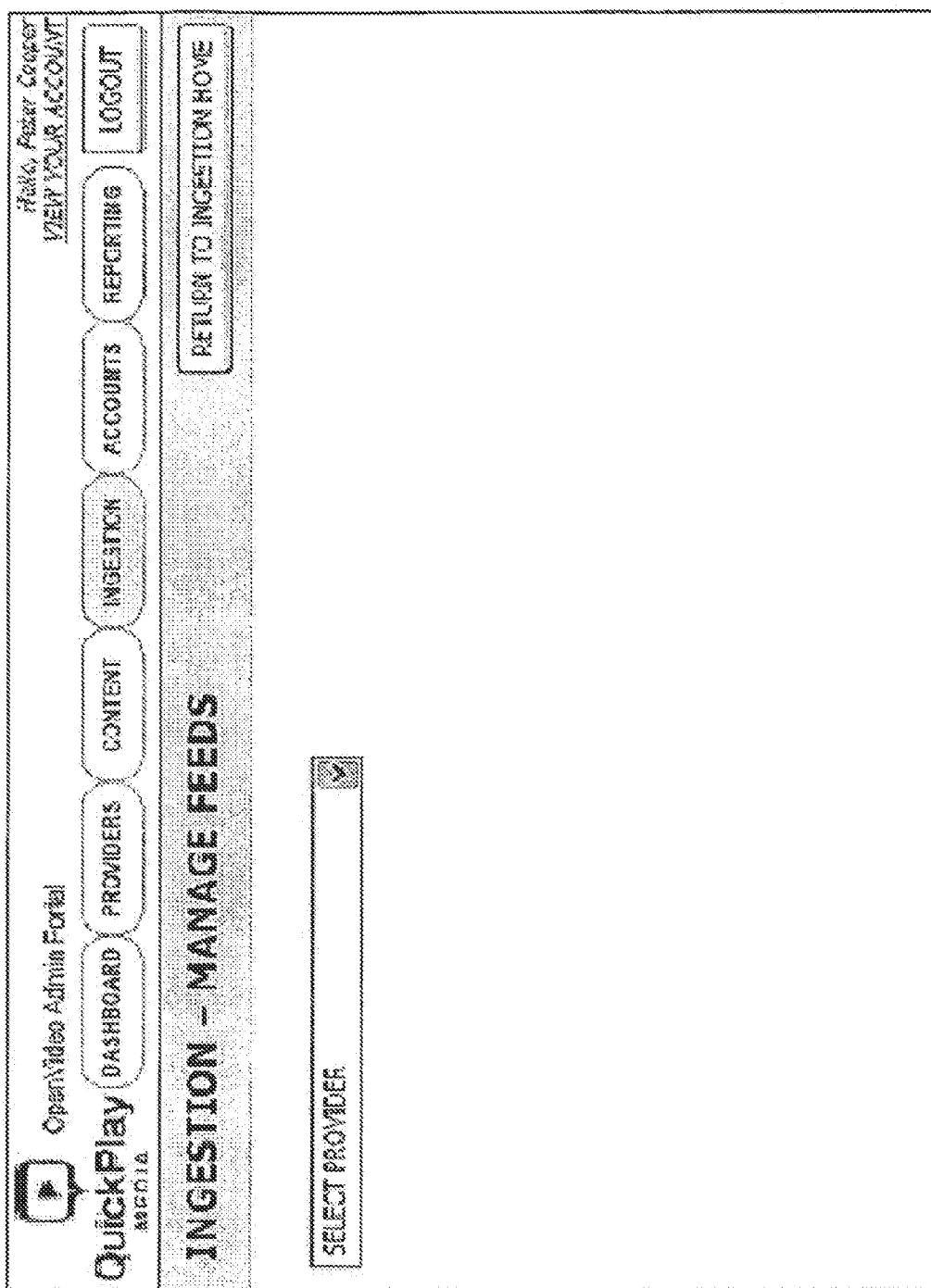

Fig. 26

OPENVIDEO ADMIN PORTAL

HELLO, PETER COOPER
[VIEW YOUR ACCOUNT](#)

[LOGOUT](#)

[QUICK PLAY MEDIA](#) [DASHBOARD](#) [PROVIDERS](#) [CONTENT](#) [INGESTION](#) [ACCOUNTS](#) [REPORTING](#)

[RETURN TO INGESTION HOME](#)

INGESTION - MANAGE FEEDS

YOUTUBE

<input type="checkbox"/>	MAIN FEED	RSS	http://www.chumlimited.com/feeds/asdfasd...
<input type="checkbox"/>	SECOND FEED	QAR	/usr/local/ingestion_services/dropoff/YouTube
<input type="checkbox"/>	THIRD FEED	RSS	http://www.chumlimited.com/feeds/asdfasd...

[DELETE SELECTED](#) [ADD NEW FEED...](#)

FIG. 27

<p>▶ OPENVIDEO ADMIN PORTAL</p> <p>QUICK PLAY MEDIA</p> <p>DASHBOARD PROVIDERS CONTENT INGESTION ACCOUNTS LOGOUT</p> <p>HELLO, PETER COOPER VIEW YOUR ACCOUNT</p>	
<p>RETURN TO INGESTION HOME</p>	
<p>INGESTION - MANAGE FEEDS</p> <ul style="list-style-type: none">• FEED BASICSCATEGORY LABELSPUBLICATION RULESINGESTION SCHEDULECOLLECTION & ENCODINGCUSTOMIZE ENCODINGSFEED SUMMARY	<p>STEP 1 OF 7: FEED BASICS</p> <p>FEED PROVIDER : YOUTUBE</p> <p>*FEED TYPE : <input type="text" value="RSS"/></p> <p>*FEED NAME : <input type="text" value="MAIN FEED"/></p>
<p><- BACK NEXT-> FINISH CANCEL</p>	

FIG. 28

OPENVIDEO ADMIN PORTAL

QUICK PLAY MEDIA

HELLO, PETER COOPER
VIEW YOUR ACCOUNT

DASHBOARD

PROVIDERS

CONTENT

INGESTION

ACCOUNTS

LOGOUT

INGESTION - MANAGE FEEDS

- * FEED BASICS
- * CATEGORY LABELS
- PUBLICATION RULES
- INGESTION SCHEDULE
- COLLECTION & ENCODING
- CUSTOMIZE ENCODINGS
- FEED SUMMARY

STEP 2 OF 7: CATEGORY LABELS

CATEGORY LABELS

* LABEL:

CARRIER:

PRODUCT:

* CATEGORY:

- PRODUCT NAME
- CATEGORY NAME
- CATEGORY NAME
- CATEGORY NAME
- CATEGORY NAME
- CATEGORY NAME
- CATEGORY NAME

<input type="checkbox"/>	MISC	ROGERS VISION -> ENTERTAINMENT -> MISC
<input type="checkbox"/>	ENTERTAINMENT	BELL STREAMING > ENTERTAINMENT > USER...
<input type="checkbox"/>	SPORTS	ROGERS VISION > WHAT'S NEW
<input type="checkbox"/>	NEW	ROGERS VISION > POPULAR CLIPS

FIG. 29

<p>OPENVIDEO ADMIN PORTAL</p> <p>HELLO, PETER COOPER VIEW YOUR ACCOUNT</p>	
<p>QUICK PLAY MEDIA</p>	<p>DASHBOARD PROVIDERS CONTENT INGESTION ACCOUNTS LOGOUT</p>
<p>INGESTION - MANAGE FEEDS</p> <p>RETURN TO INGESTION HOME</p>	
<ul style="list-style-type: none">• FEED BASICS• CATEGORY LABELS• PUBLICATION RULES <p>INGESTION SCHEDULE COLLECTION & ENCODING CUSTOMIZE ENCODINGS FEED SUMMARY</p>	<p>STEP 3 OF 7: PUBLICATION RULES</p> <p>*PUBLICATION BEHAVIOUR:</p> <ul style="list-style-type: none"><input checked="" type="radio"/> SIMPLE: RUN PUBLICATION ONCE FOR EVERY NEW CLIP FOUND (GOOD FOR FEEDS WHICH ARE UPDATED FREQUENTLY WITH A SMALL NUMBER OF NEW CLIPS)<input type="radio"/> BATCH: RUN PUBLICATION FOR ALL THE NEW CLIPS AT THE SAME TIME (GOOD FOR FEEDS WHICH ARE UPDATED INFREQUENTLY WITH A LARGE NUMBER OF NEW CLIPS ALL AT ONCE) <p>*DEFAULT CATEGORY: ENTERTAINMENT</p>
<p><- BACK NEXT -> FINISH CANCEL</p>	

FIG. 30

<p>OPENVIDEO ADMIN PORTAL</p> <p>HELLO, PETER COOPER VIEW YOUR ACCOUNT</p> <p>LOGOUT</p>	
<p>QUICK PLAY MEDIA</p>	<p>DASHBOARD PROVIDERS CONTENT</p> <p>INGESTION ACCOUNTS</p>
<p>INGESTION - MANAGE FEEDS</p> <p>RETURN TO INGESTION HOME</p>	
<ul style="list-style-type: none"> • FEED BASICS • CATEGORY LABELS • PUBLICATION RULES • INGESTION SCHEDULE • COLLECTION & ENCODING • CUSTOMIZE ENCODINGS • FEED SUMMARY 	<p>STEP 4 OF 7: INGESTION SCHEDULE</p> <p>INGESTION: <input type="radio"/> NEVER <input type="radio"/> ONCE, ON: <input type="text" value="12"/> <input type="text" value="31"/> <input type="text" value="2007"/> <input type="text" value="0"/> <input type="text" value="0"/> HOURS(S), <input type="text" value="0"/> <input type="text" value="0"/> MIN(S) <input checked="" type="radio"/> EVERY: <input type="text" value="0"/> <input type="text" value="30"/> DAYS(S), <input type="text" value="0"/> <input type="text" value="0"/> HOURS(S), <input type="text" value="0"/> <input type="text" value="0"/> MIN(S) <input type="radio"/> EVERY: <input type="checkbox"/> MON <input type="checkbox"/> TUE <input type="checkbox"/> WED <input type="checkbox"/> THU <input type="checkbox"/> FRI <input type="checkbox"/> SAT <input type="checkbox"/> SUN</p> <p>STARTING: <input type="text" value="23"/> <input type="text" value="15"/> (hh:mm)</p> <p><- BACK NEXT-> FINISH CANCEL</p>

FIG. 31

<p>OPENVIDEO ADMIN PORTAL</p> <p>QUICK PLAY MEDIA</p> <p>DASHBOARD PROVIDERS CONTENT INGESTION ACCOUNTS LOGOUT</p> <p>HELLO, PETER COOPER VIEW YOUR ACCOUNT</p>	
<p>INGESTION - MANAGE FEEDS</p> <p>RETURN TO INGESTION HOME</p>	
<ul style="list-style-type: none">• FEED BASICS• CATEGORY LABELS• PUBLICATION RULES• INGESTION SCHEDULE• COLLECTION & ENCODING <p>CUSTOMIZE ENCODINGS</p> <p>FEED SUMMARY</p>	<p>STEP 5 OF 7: COLLECTION & ENCODING</p> <p>COLLECT FROM[URL PATH]: <input type="text" value="http://rss.boobar.com/boobar.xml"/></p> <p>SECURE?: <input type="checkbox"/></p> <p>*USERNAME: <input type="text" value="QUICKPLAY"/></p> <p>*PASSWORD: <input type="text" value="123ABC"/></p> <p>PERFORM ENCODING? <input checked="" type="checkbox"/></p> <p>FIRST ENCODING PASS: <input type="text" value="HLV TO AVI"/></p> <p>< BACK NEXT -> FINISH CANCEL</p>

FIG. 32

OPENVIDEO ADMIN PORTAL

QUICK PLAY MEDIA

HELLO, PETER COOPER
VIEW YOUR ACCOUNT

DASHBOARD

PROVIDERS

CONTENT

INGESTION

ACCOUNTS

LOGOUT

INGESTION - MANAGE FEEDS

- FEED BASICS
- CATEGORY LABELS
- PUBLICATION RULES
- INGESTION SCHEDULE
- COLLECTION & ENCODING
- CUSTOMIZE ENCODINGS

STEP 6 OF 7: CUSTOMIZE ENCODINGS ENCODINGS

USE THE CONTROL BELOW TO OVERRIDE A DEFAULT ENCODING PROFILE WITH ANY REQUIREMENTS THAT ARE UNIQUE FOR THIS PROVIDER. A *INDICATES THAT AN ENCODING HAS BEEN MODIFIED

* FLY TO AVI

```
<entry key="MEncoderPass1GlobalParameters">-ofps 30
noencodedups -nobps -nosound -vf pp=allfb,scale=352:288</entry>
<entry key="MEncoderPass1SpecificParameters">-ovc lavc-lavcopits
```

SAVE

RESTORE DEFAULT

<- BACK

NEXT->

FINISH

CANCEL

FIG. 33

<p>OPENVIDEO ADMIN PORTAL</p> <p>HELLO, PETER COOPER VIEW YOUR ACCOUNT</p> <p>LOGOUT</p> <p>ACCOUNTS</p> <p>INGESTION</p> <p>CONTENT</p> <p>PROVIDERS</p> <p>DASHBOARD</p> <p>QUICK PLAY MEDIA</p>	
<p>INGESTION - MANAGE FEEDS</p> <p>RETURN TO INGESTION HOME</p>	
<ul style="list-style-type: none">• FEED BASICS• CATEGORY LABELS• PUBLICATION RULES• INGESTION SCHEDULE• COLLECTION & ENCODING• CUSTOMIZE ENCODINGS• FEED SUMMARY	<p>STEP 7 OF 7: SUMMARY</p> <p>NAME: MAIN DAILY FEED</p> <p>CATEGORY LABELS: ENTERTAINMENT, MUSIC, SPORTS</p> <p>URL http://rss.todbar.com/todbar.xml</p> <p>PUBLICATION METHOD: SIMPLE</p> <p>DEFAULT LABEL: ENTERTAINMENT</p> <p>SCHEDULE: EVERY MONDAY, WEDNESDAY, FRIDAY STARTING AT 13:45</p> <p>ENCODINGS: FLV TO AVI, AVI TO EDGE, AVI TO HSDPA</p> <p>< BACK NEXT > FINISH CANCEL</p>

FIG. 34

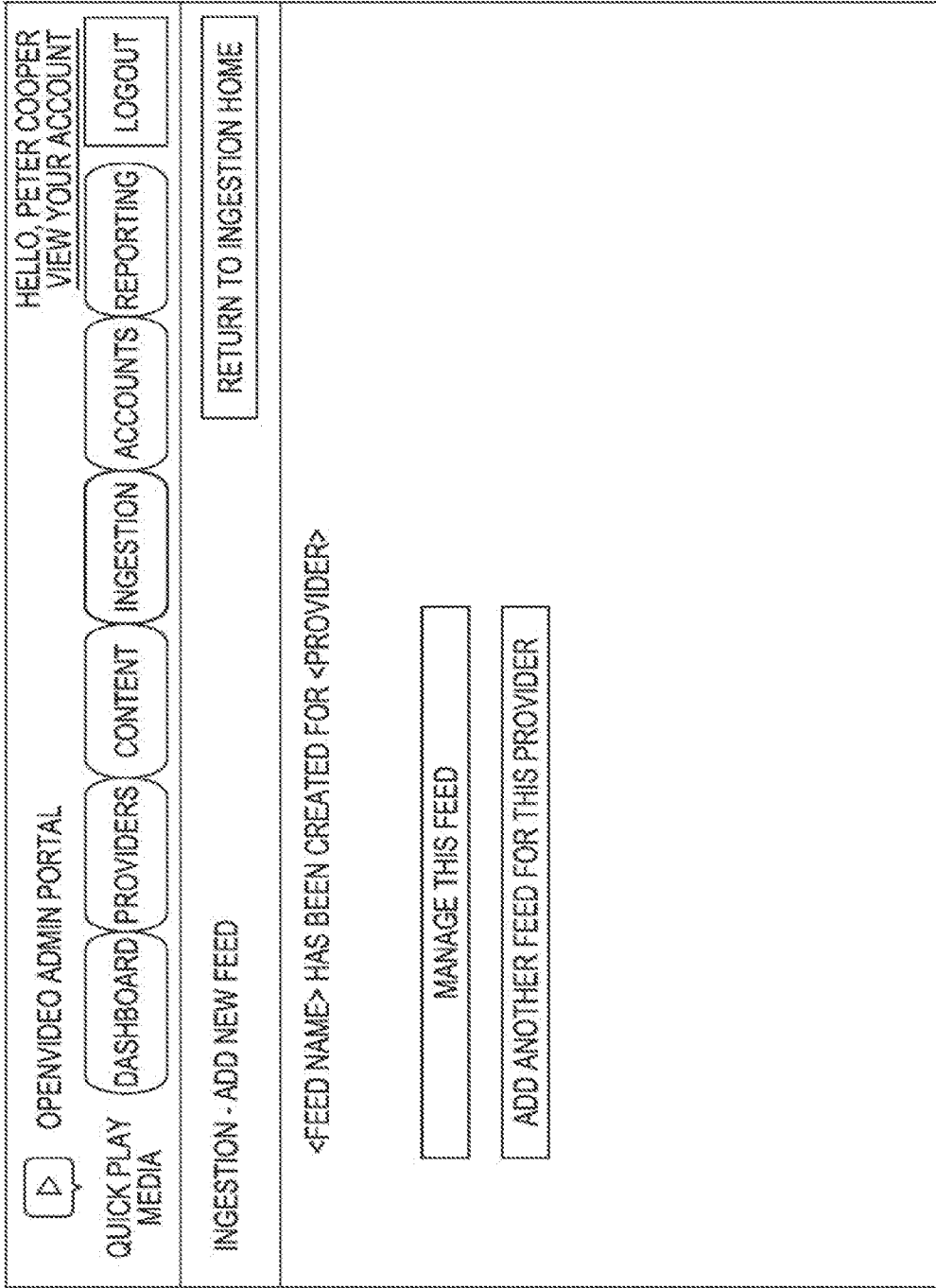



FIG. 35



OPENVIDEO ADMIN PORTAL

HELLO, PETER COOPER
VIEW YOUR ACCOUNT

DASHBOARD

PROVIDERS

CONTENT

INGESTION

ACCOUNTS

LOGOUT

QUICK PLAY MEDIA

RETURN TO INGESTION HOME

NAME	SCHEDULE	LAST EXECUTION	NEXT EXECUTION	PASS?
<input type="checkbox"/> YOUTUBE -> MAIN FEED	EVERY 2 DAYS, AT 14:23	12/24/07 - 23:45:01	CURRENTLY RUNNING	YES
<input type="checkbox"/> CHUM -> SECOND FEED	EVERY MON, WED, FRI, AT 14:23	12/24/07 - 23:45:01	12/16/07 - 23:45:01	YES
<input type="checkbox"/> YOUTUBE -> OTHER	EVERY MON, WED, FRI, AT 14:23	-	12/19/07 - 23:45:01	YES
<input type="checkbox"/> CHUM -> SECOND FEED	EVERY 20 MINUTES	12/24/07 - 23:45:01	12/18/07 - 23:45:01	NO
<input type="checkbox"/> YOUTUBE -> OTHER	EVERY 60 MINUTES	12/24/07 - 23:45:01	12/19/07 - 23:45:01	YES
<input type="checkbox"/> CHUM -> SECOND FEED	EVERY MON, WED, FRI, AT 14:23	12/24/07 - 23:45:01	12/20/07 - 23:45:01	YES
<input type="checkbox"/> YOUTUBE -> OTHER	EVERY MON, WED, FRI, AT 14:23	-	12/21/07 - 23:45:01	NO
<input type="checkbox"/> CHUM -> SECOND FEED	EVERY 20 MINUTES	12/24/07 - 23:45:01	12/28/07 - 23:45:01	NO
<input type="checkbox"/> YOUTUBE -> OTHER	EVERY 60 MINUTES	12/24/07 - 23:45:01	12/29/07 - 23:45:01	YES
<input type="checkbox"/> CHUM -> SECOND FEED	EVERY MON, WED, FRI, AT 14:23	12/24/07 - 23:45:01	12/30/07 - 23:45:01	YES
<input type="checkbox"/> YOUTUBE -> OTHER	EVERY MON, WED, FRI, AT 14:23	-	12/31/07 - 23:45:01	YES
<input type="checkbox"/> CHUM -> SECOND FEED	EVERY 20 MINUTES	12/24/07 - 23:45:01	PAUSED	YES
<input type="checkbox"/> YOUTUBE -> OTHER	EVERY 60 MINUTES	12/24/07 - 23:45:01	PAUSED	YES

<<PREV 12/31/15 NEXT->>

CHOOSE ACTION

FIG. 36

OPENVIDEO ADMIN PORTAL

HELLO, PETER COOPER
VIEW YOUR ACCOUNT

LOGOUT

QUICK PLAY MEDIA

DASHBOARD PROVIDERS CONTENT INGESTION ACCOUNTS REPORTING

RETURN TO INGESTION HOME

INGESTION - ADD ENCODING PROFILE

*NAME:

*CONFIGURATION:

```
<entry key="MEncoderPass1GlobalParameters">-ofps 30
noencodedups -nobps -nosound -vf pp=allb,scale=352:288</entry>
<entry key="MEncoderPass1SpecificParameters">-ovc lavc-lavcopts
vcodec-mpeg4: vpass=1: turbo.vqscale=2</entry>
<entry key="MEncoderPass1GlobalParameters">-ofps 30
noencodedups -nobps -nosound -vf pp=allb,scale=352:288</entry>
<entry key="MEncoderPass1SpecificParameters">-ovc lavc-lavcopts
vcodec-mpeg4: vpass=1: turbo.vqscale=2</entry>
```

SAVE CANCEL

FIG. 37

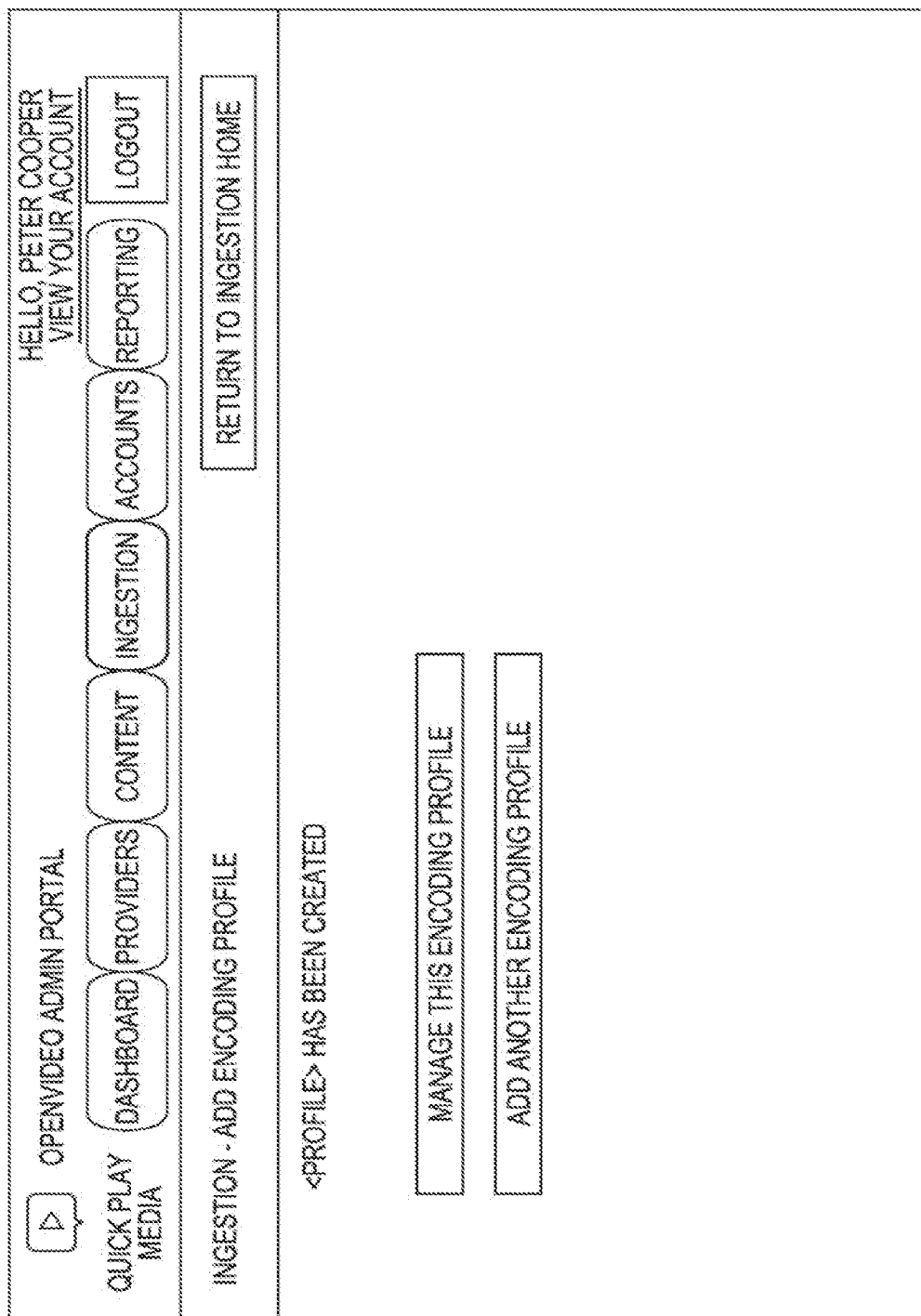

FIG. 38

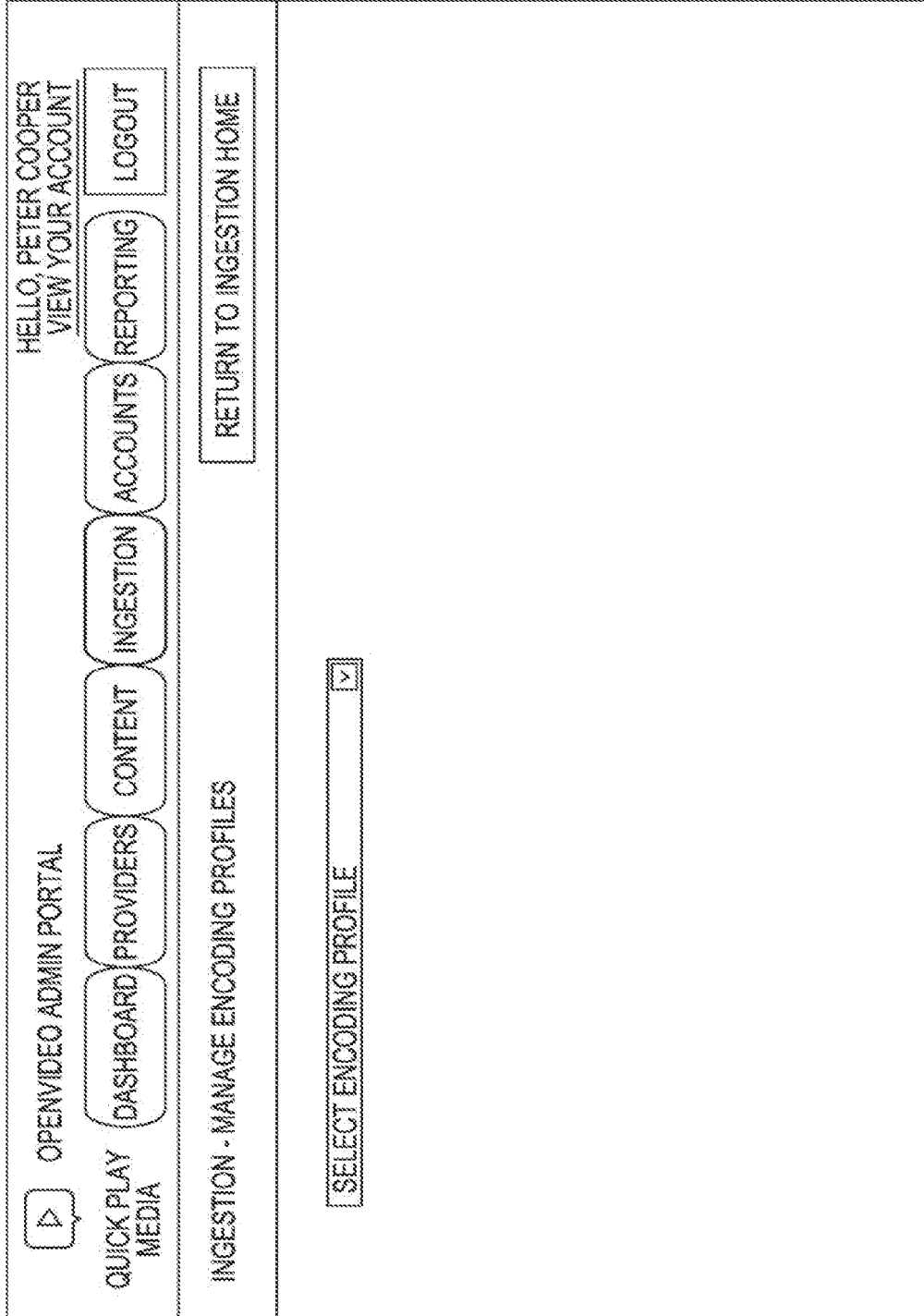

FIG. 39

OPENVIDEO ADMIN PORTAL

QUICK PLAY MEDIA

DASHBOARD PROVIDERS CONTENT

HELLO, PETER COOPER
VIEW YOUR ACCOUNT

REPORTING ACCOUNTS

LOGOUT

INGESTION - MANAGE ENCODING PROFILES

RETURN TO INGESTION HOME

SELECT ENCODING PROFILE v

CHANGES TO <PROFILE> HAVE BEEN SAVED

*NAME:

*CONFIGURATION

```

<entry key="MEncoderPass1GlobalParameters">-oips 30
noencodetups -nobps -nosound -vf pp=alfb,scale=352:288</entry>
<entry key="MEncoderPass1SpecificParameters">-ovc lavc-lavcopts
vcodec=mpeg4,vpass=1:turbo,vqscale=2</entry>
<entry key="MEncoderPass1GlobalParameters">-oips 30
noencodetups -nobps -nosound -vf pp=alfb,scale=352:288</entry>
<entry key="MEncoderPass1SpecificParameters">-ovc lavc-lavcopts
vcodec=mpeg4,vpass=1:turbo,vqscale=2</entry>

```

FIG. 40

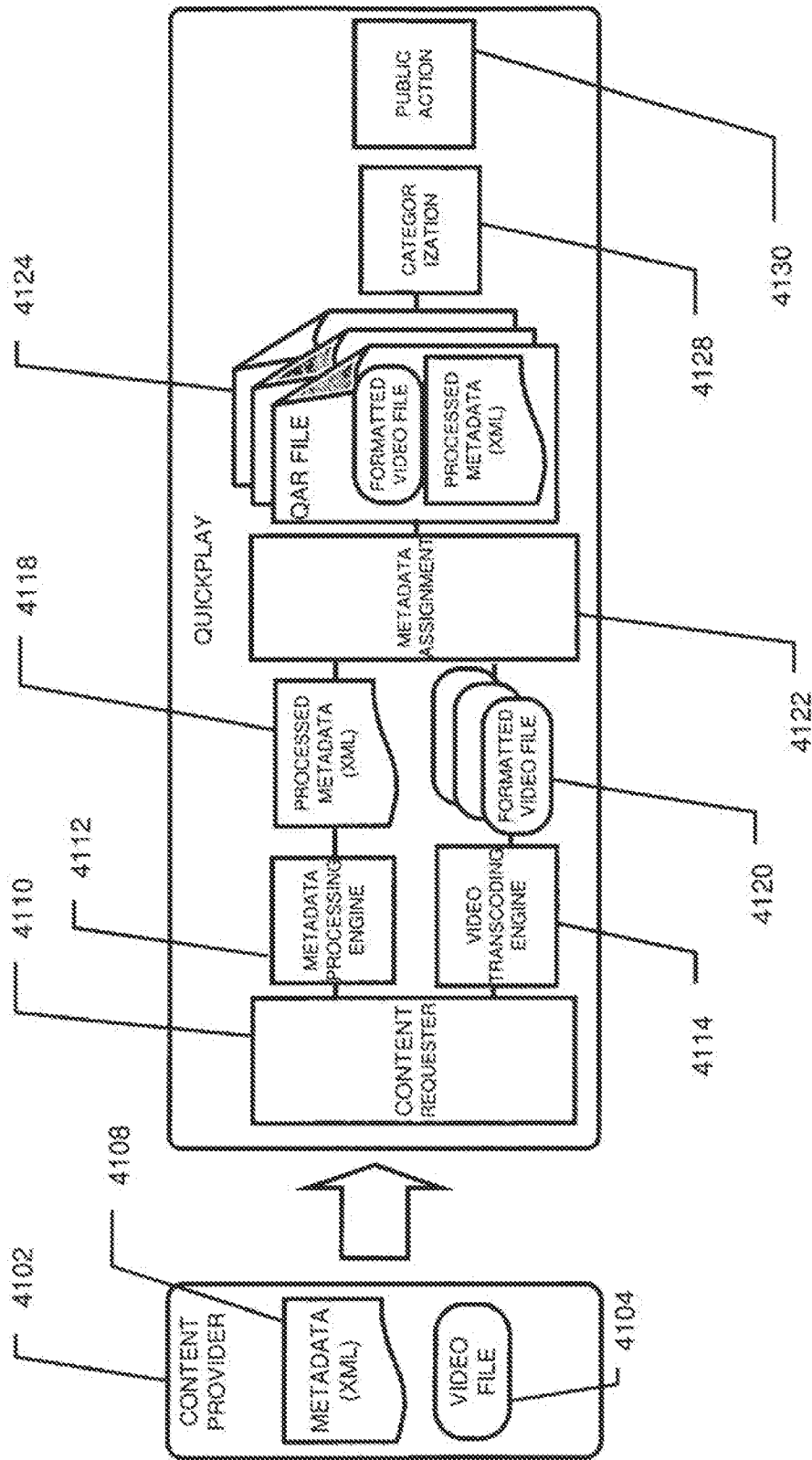

Fig. 41

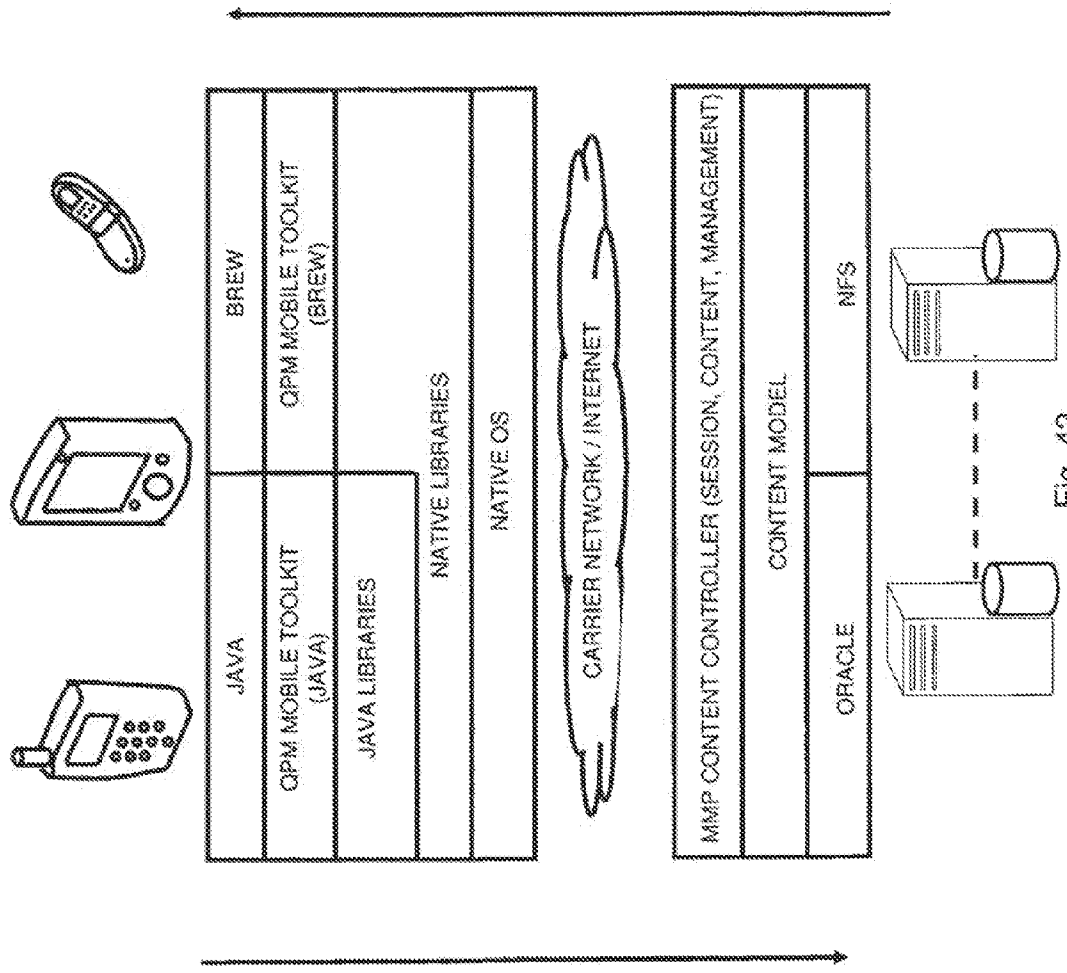

Fig. 42

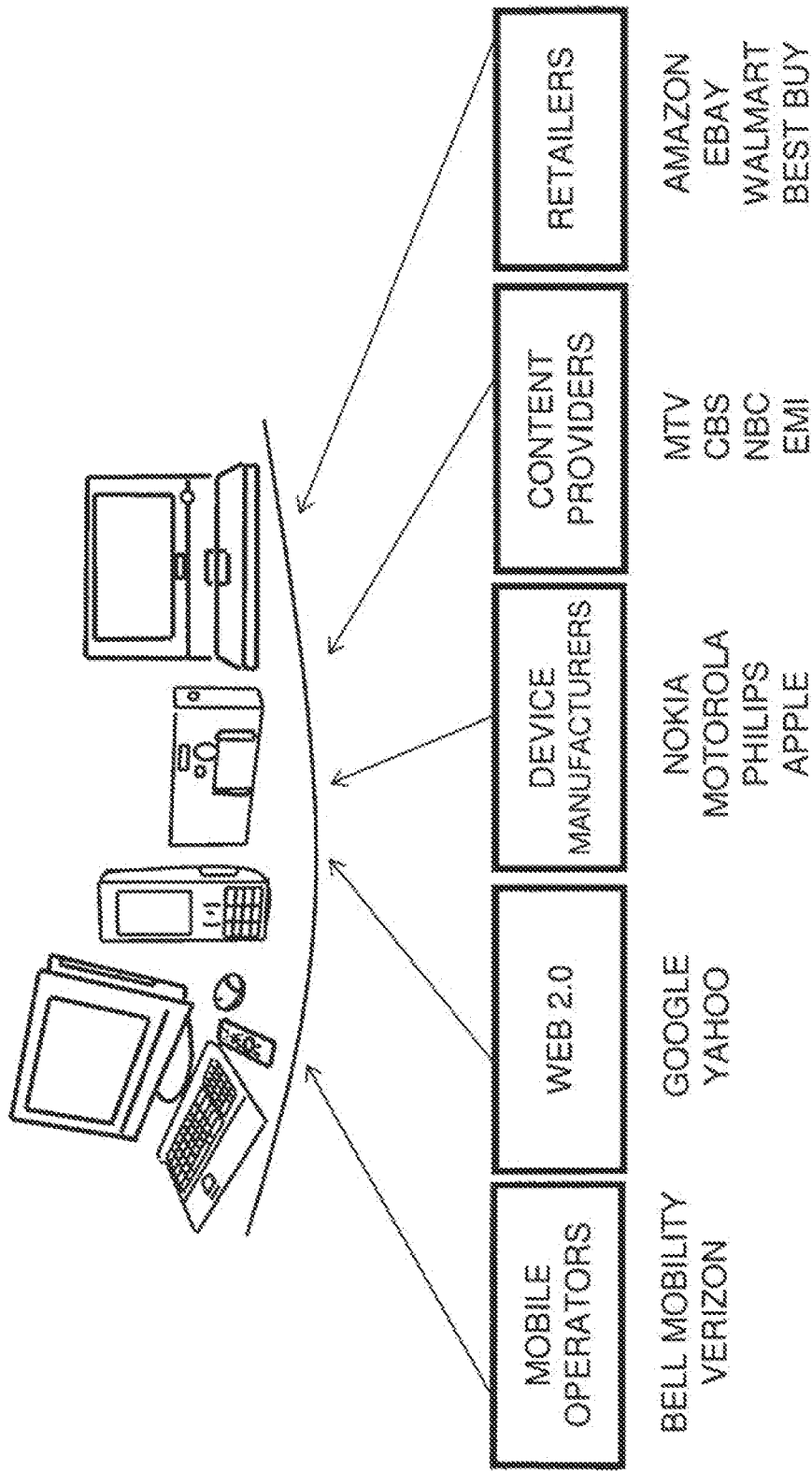

Fig. 43

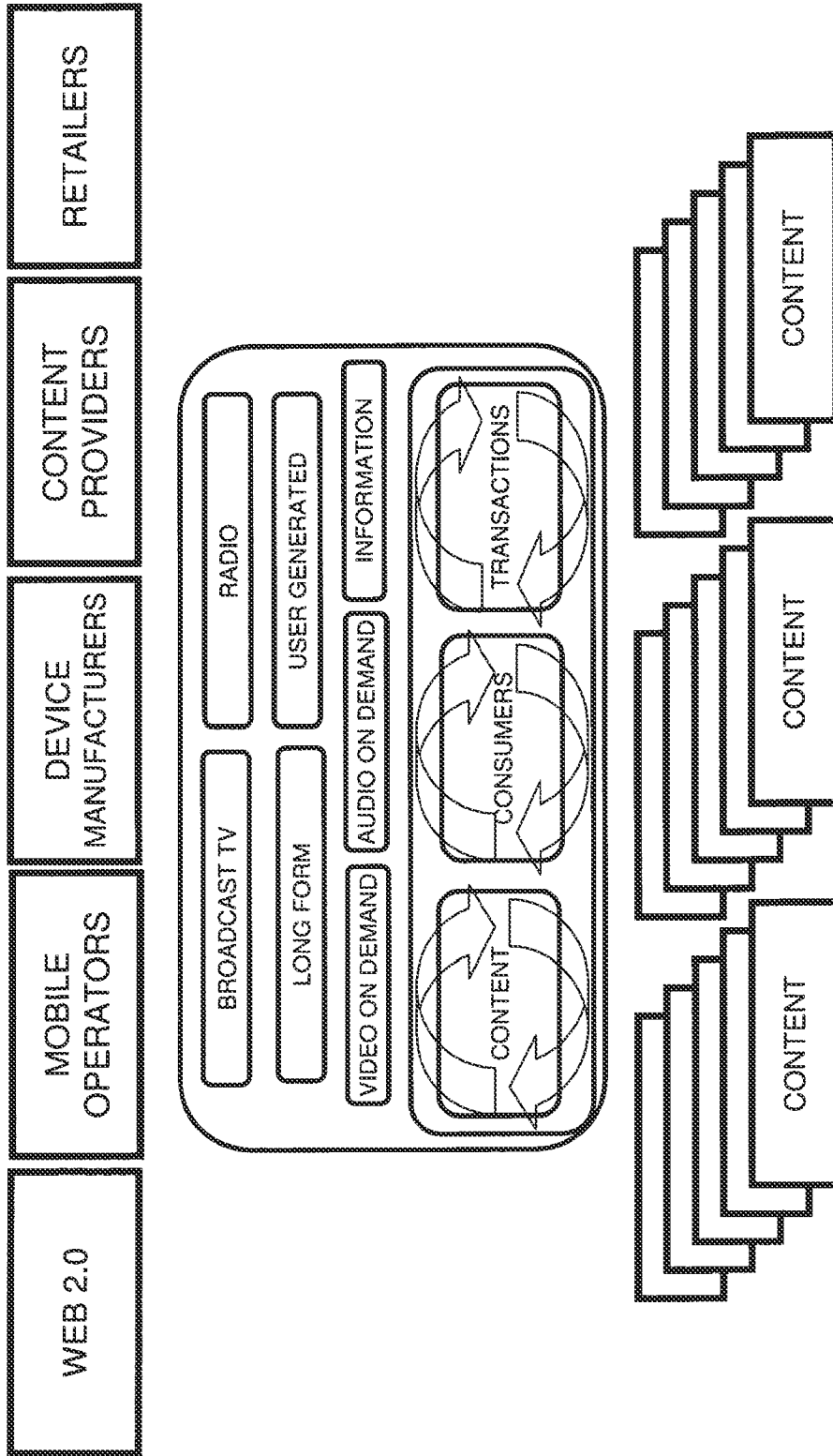

Fig. 44

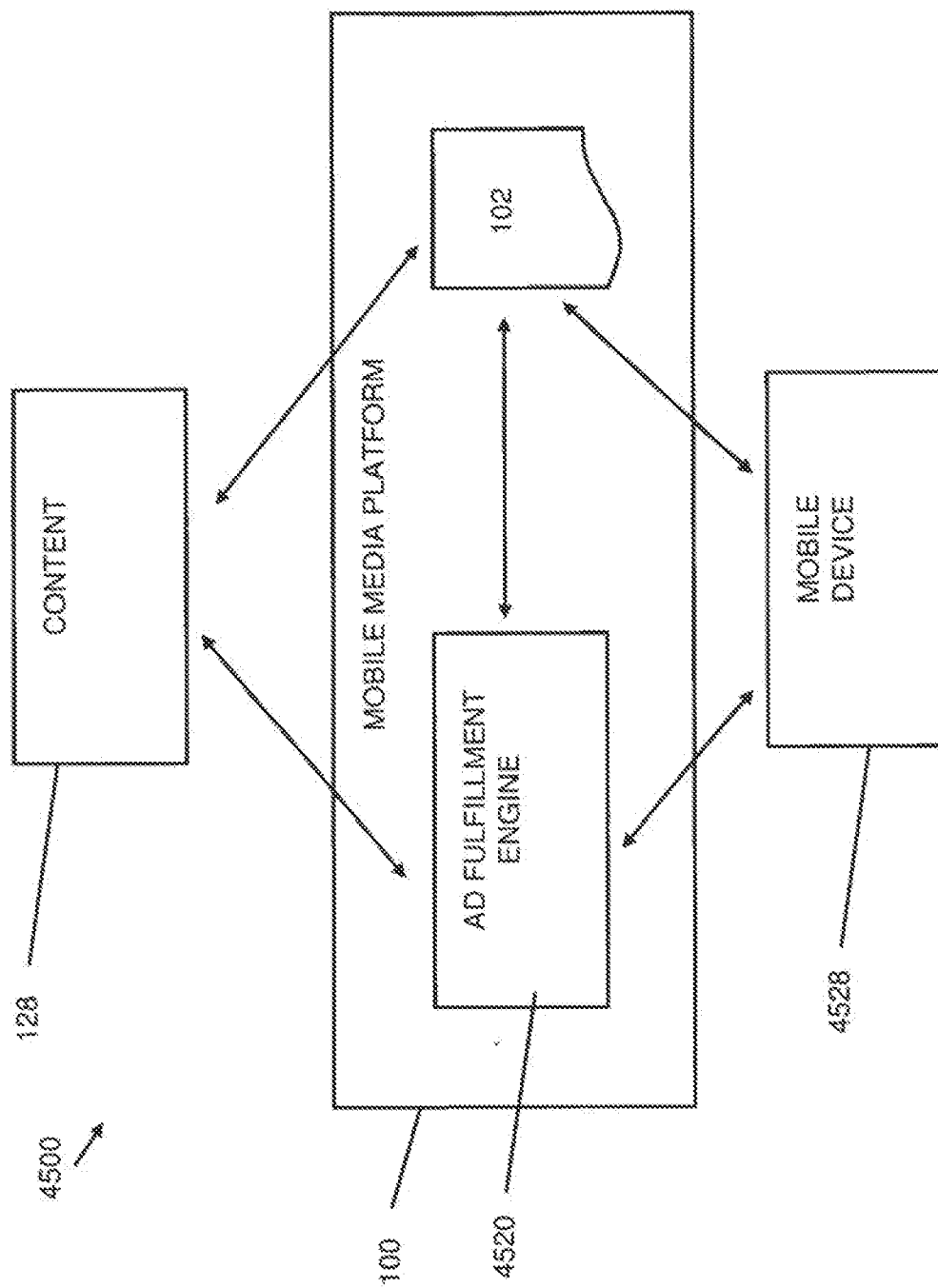

Fig. 45

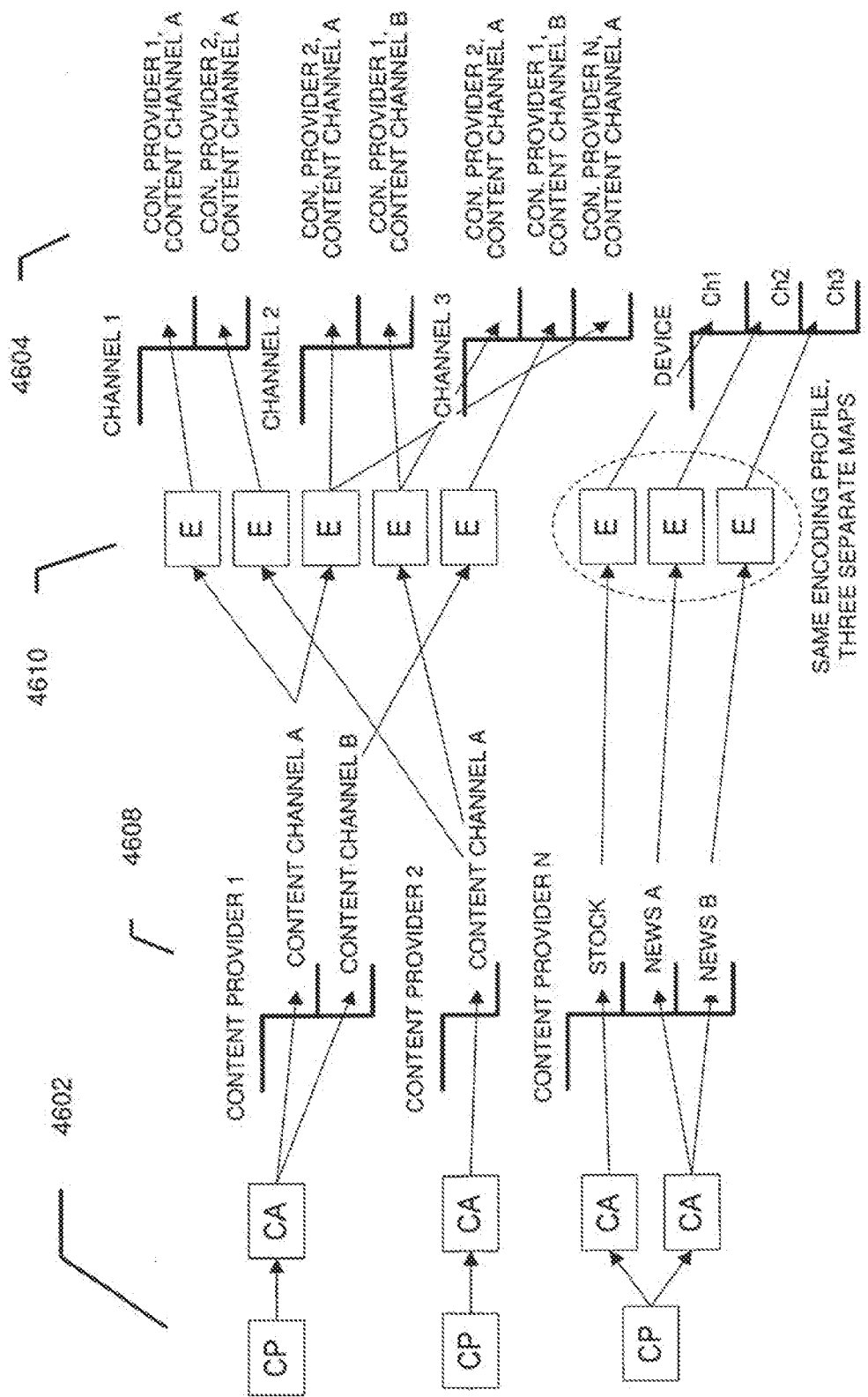

Fig. 46

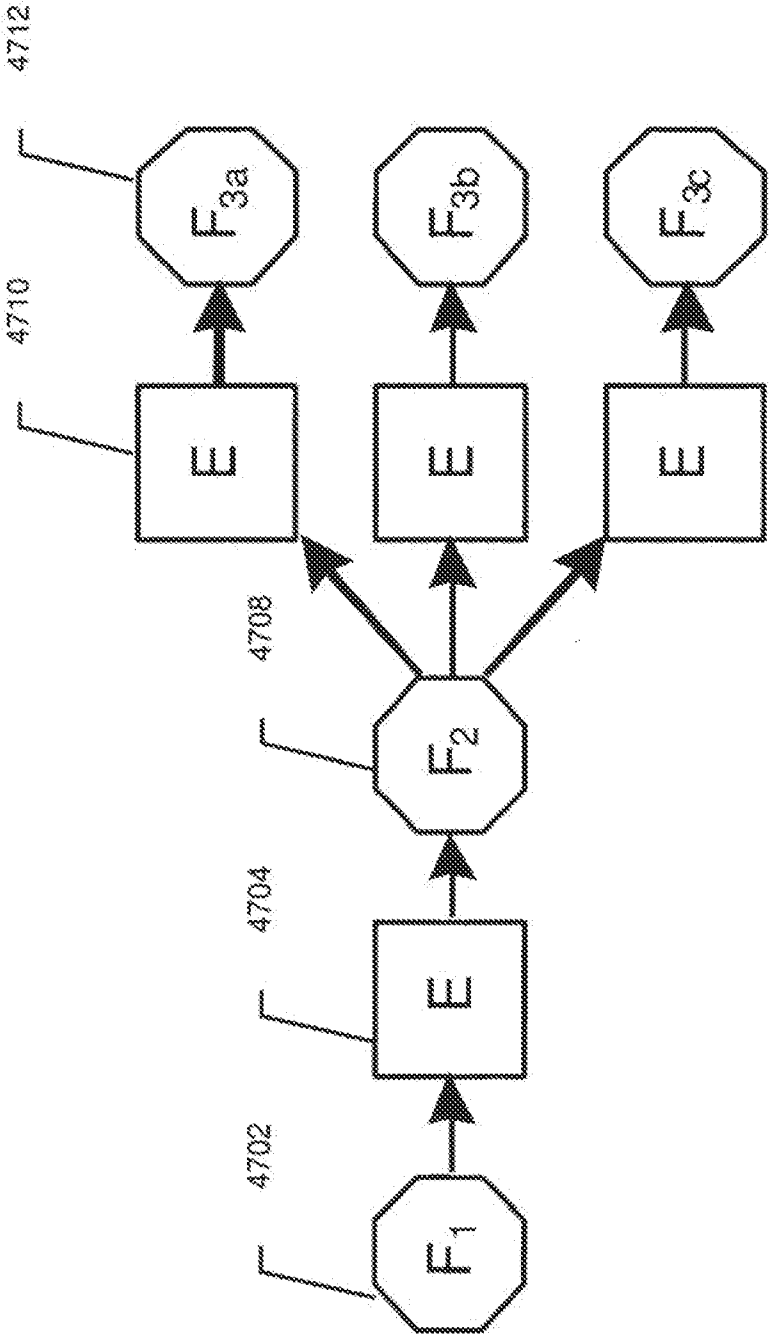

Fig. 47

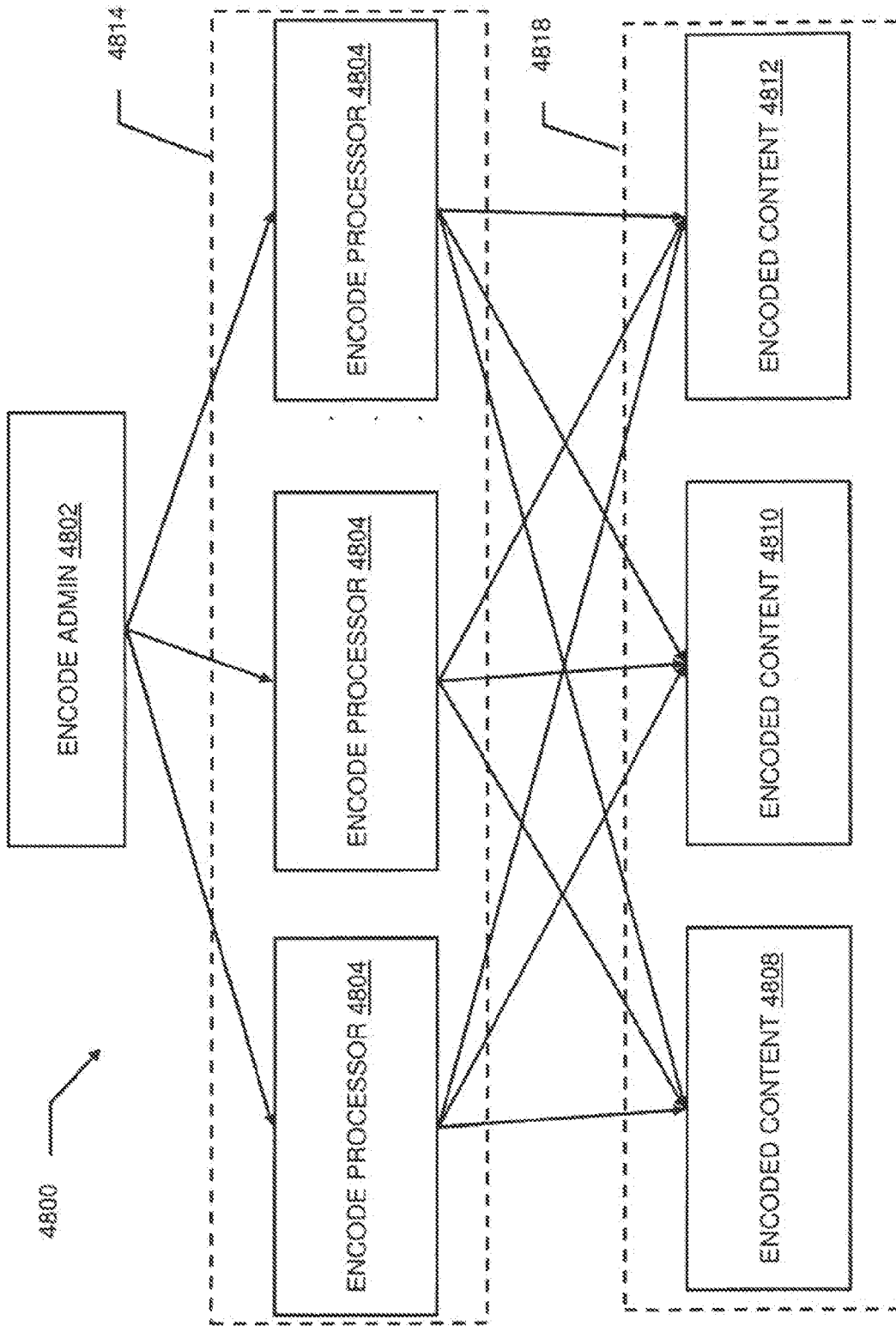

Fig. 48

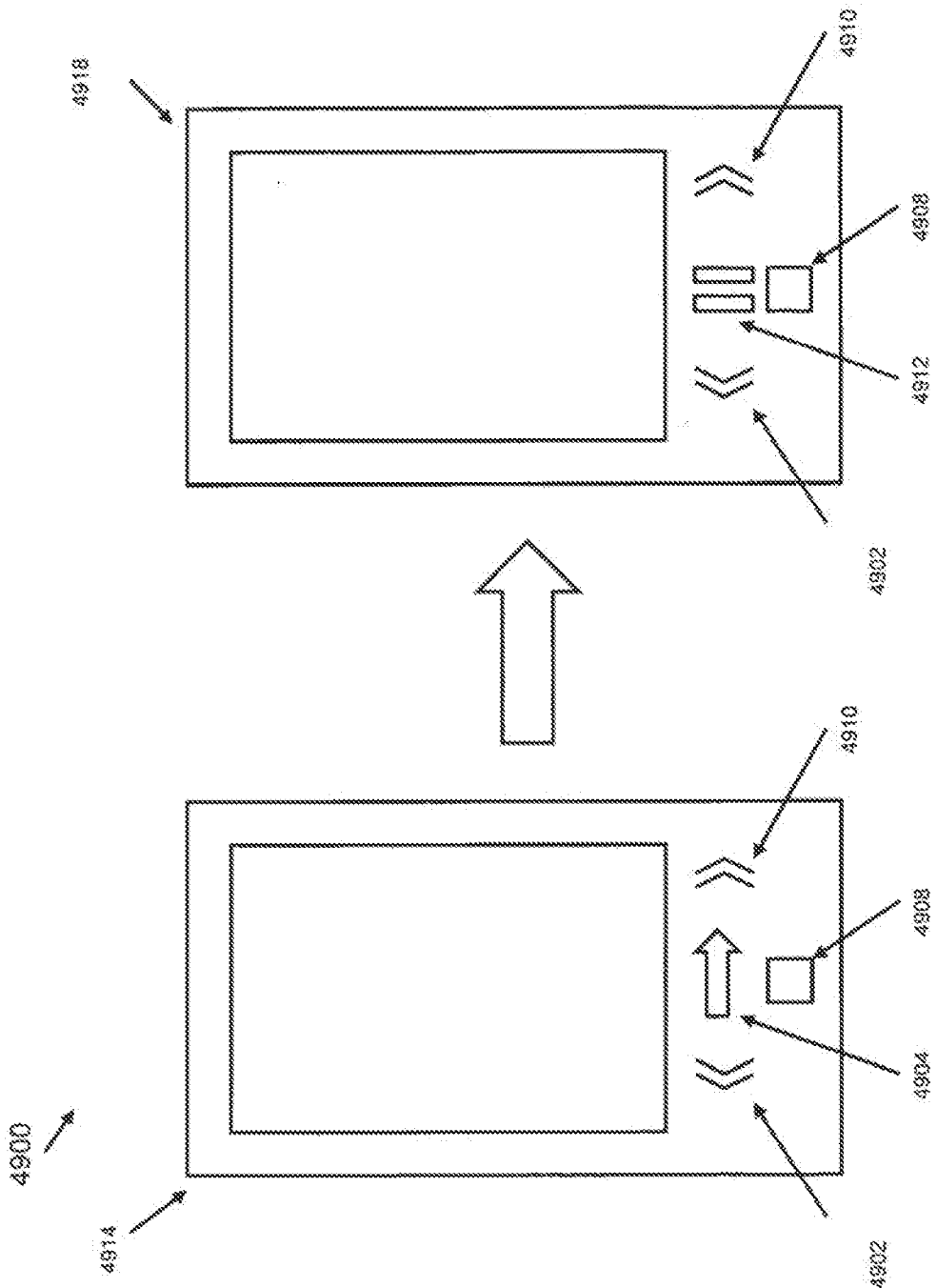

Fig. 49

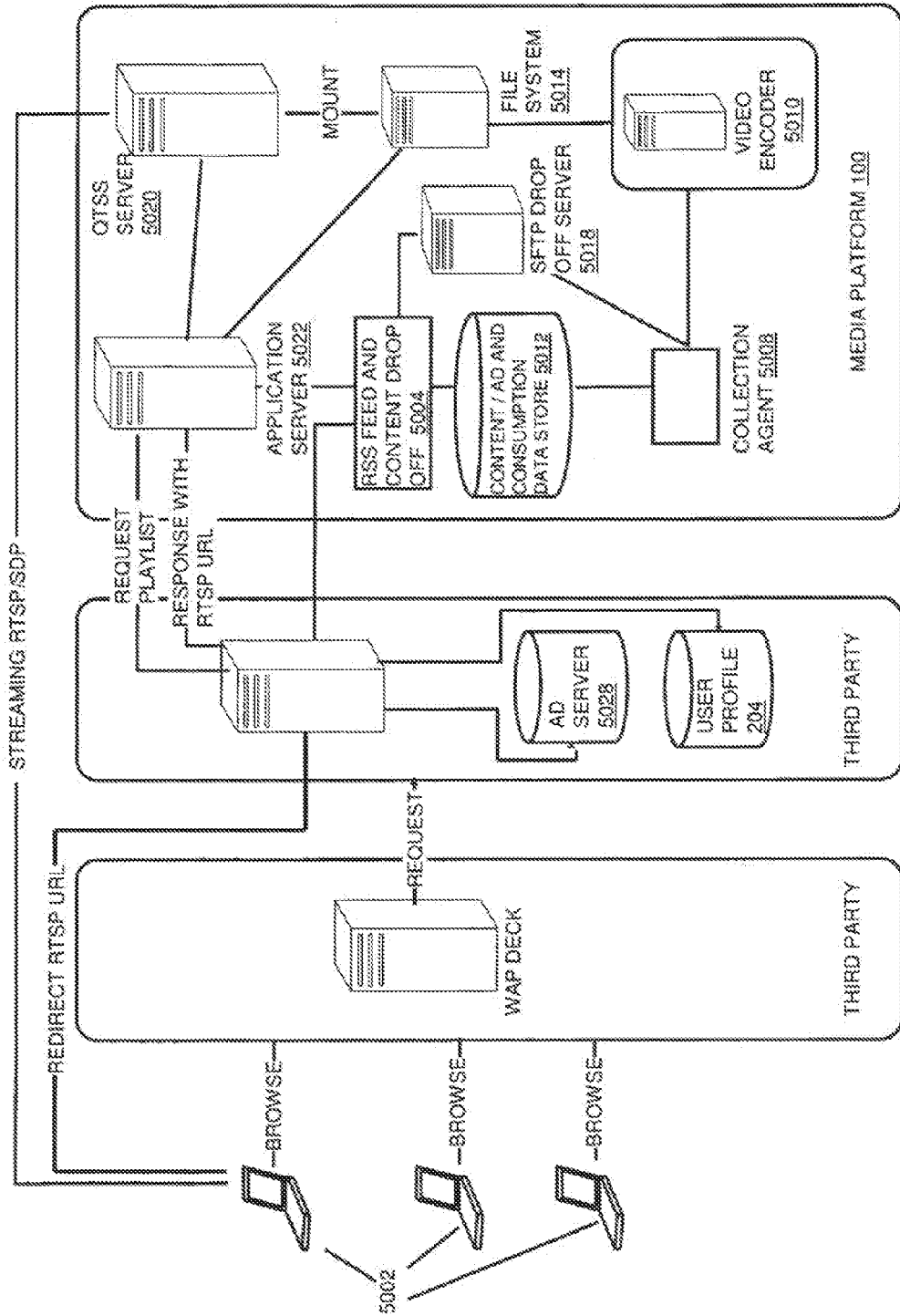

Fig. 50

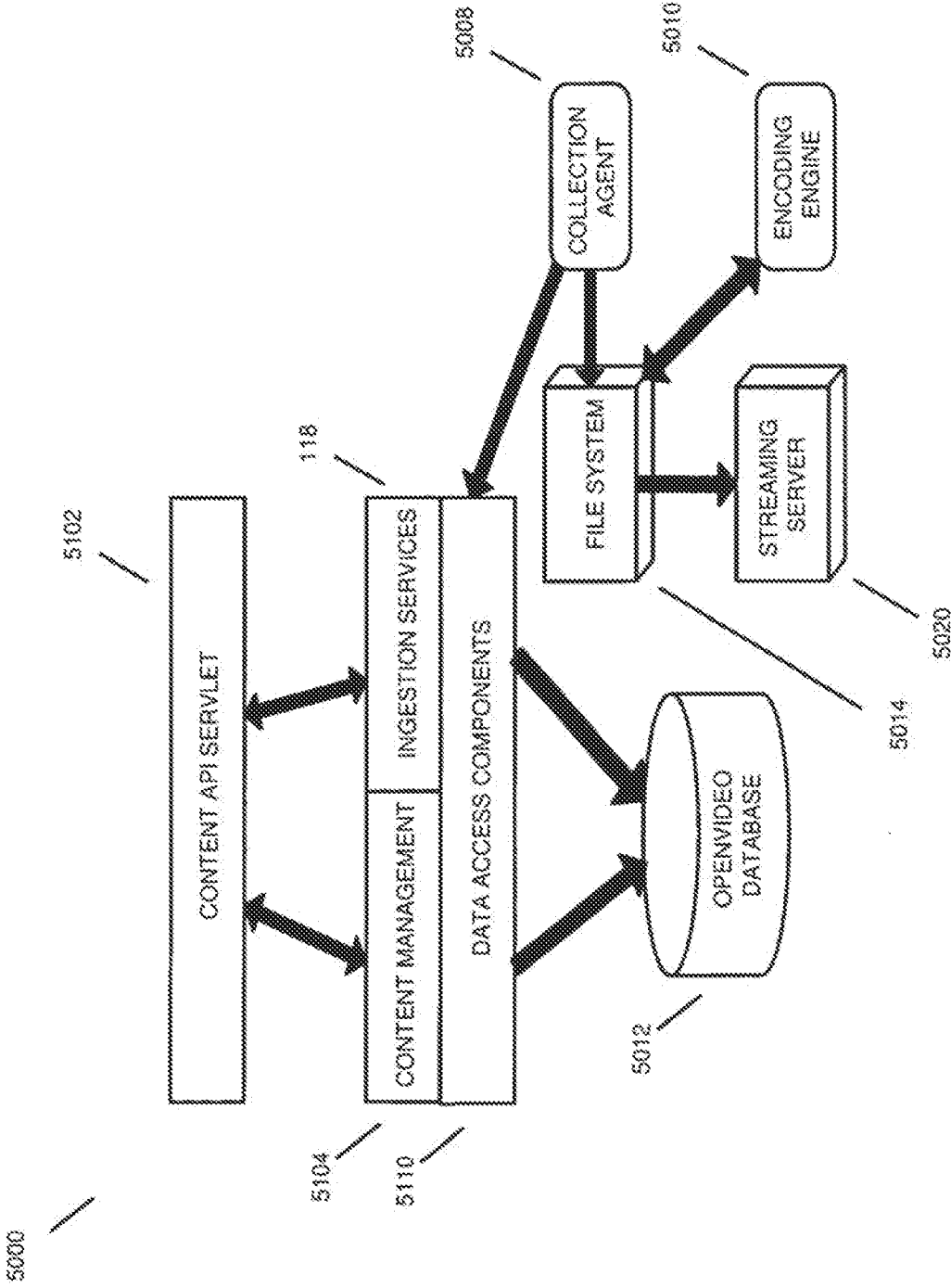

Fig. 51

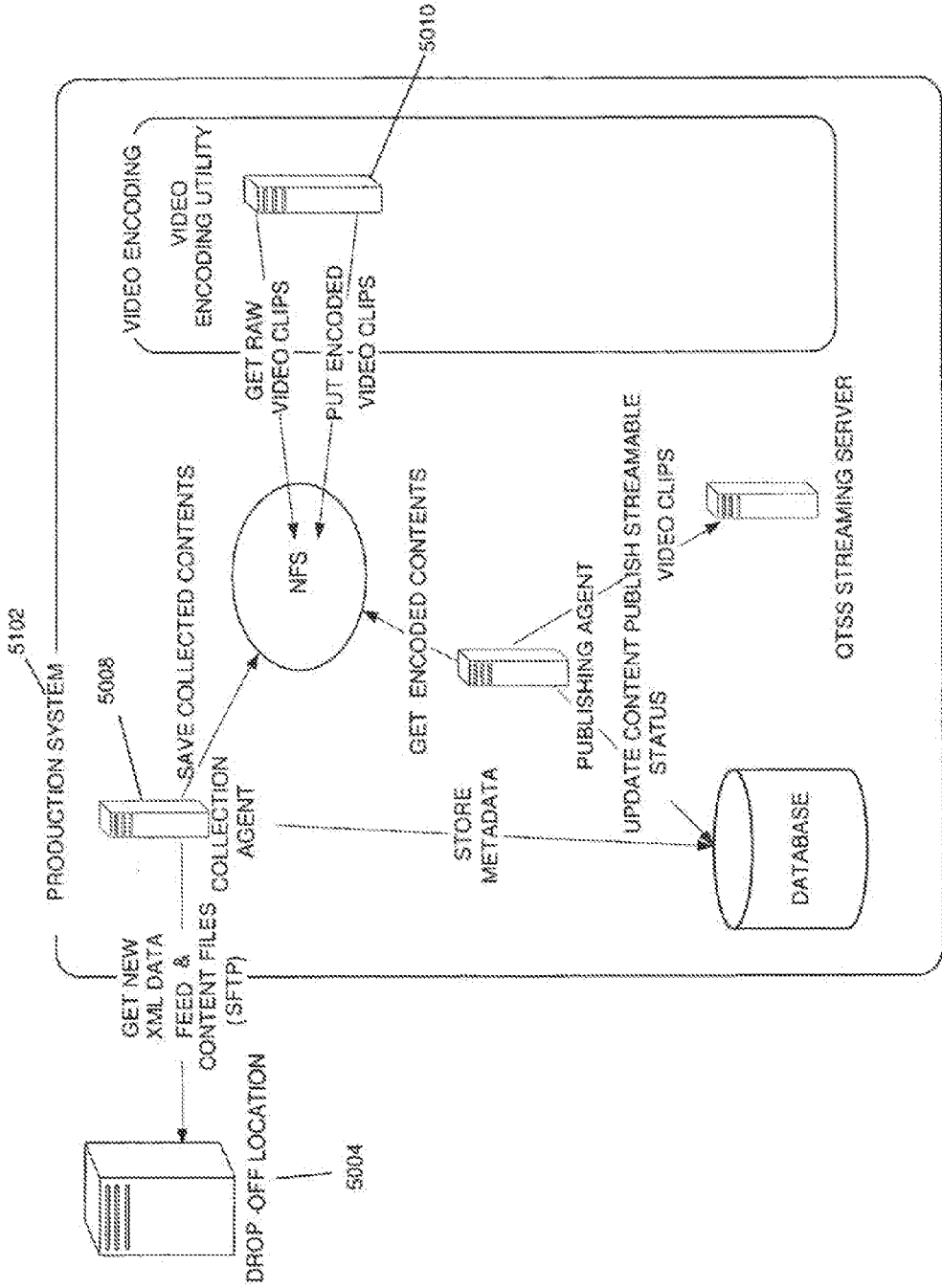

Fig. 52

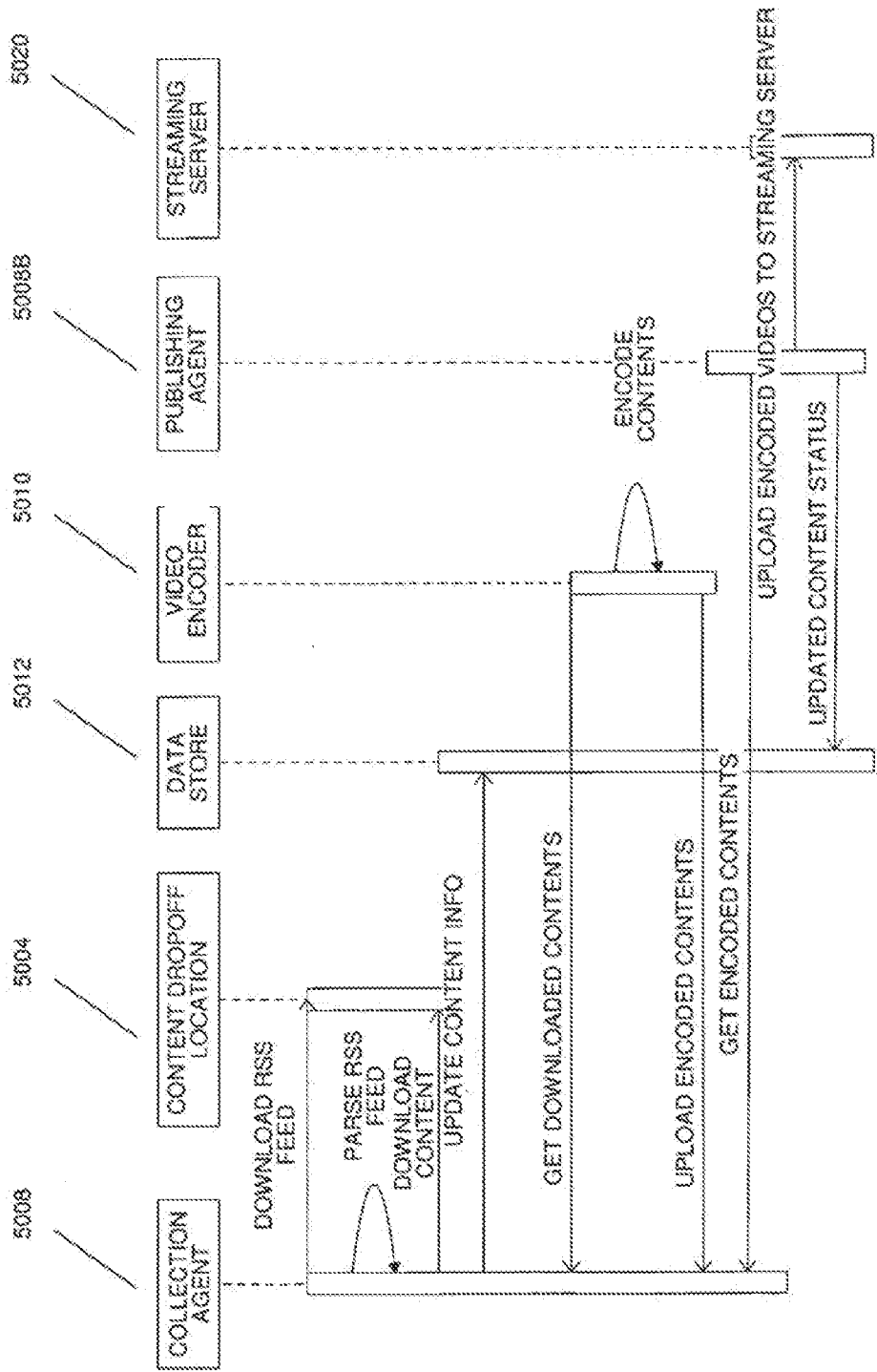

Fig. 53

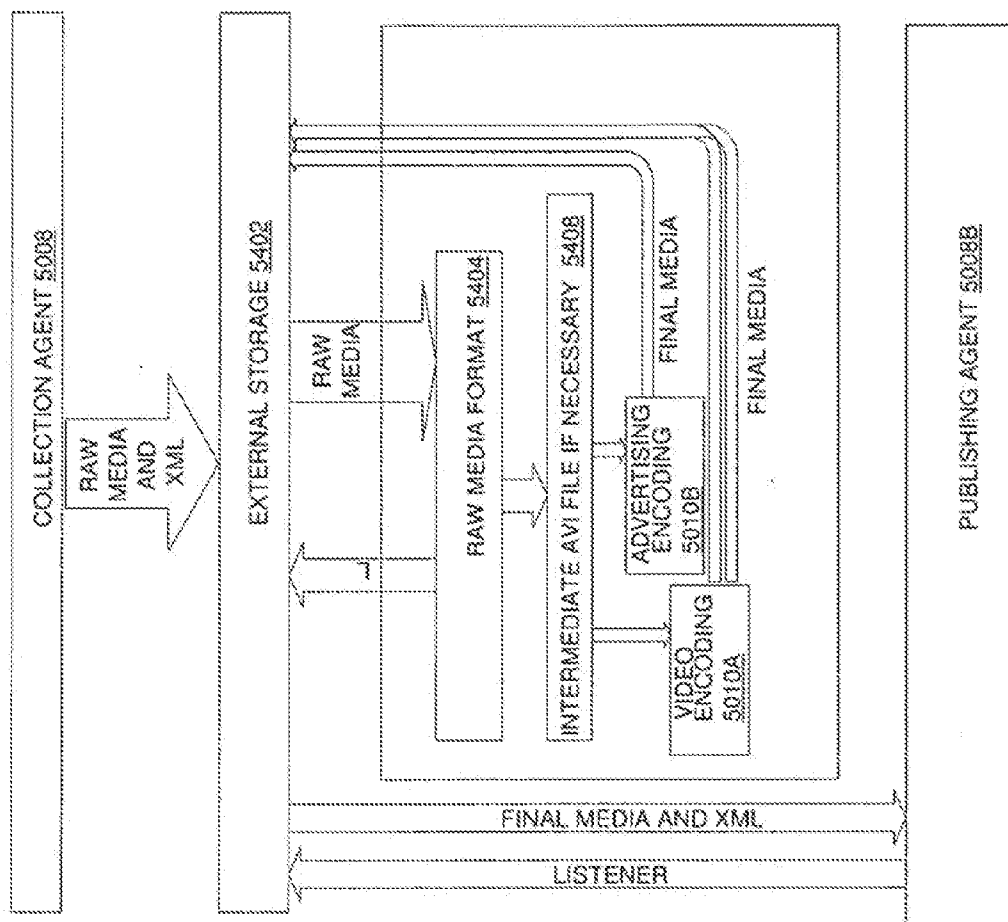

Fig. 54

5500

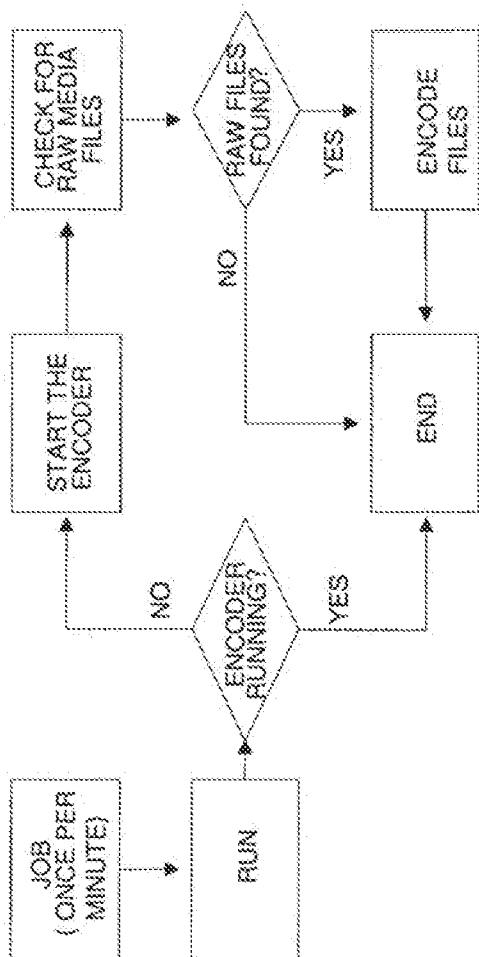

Fig. 55

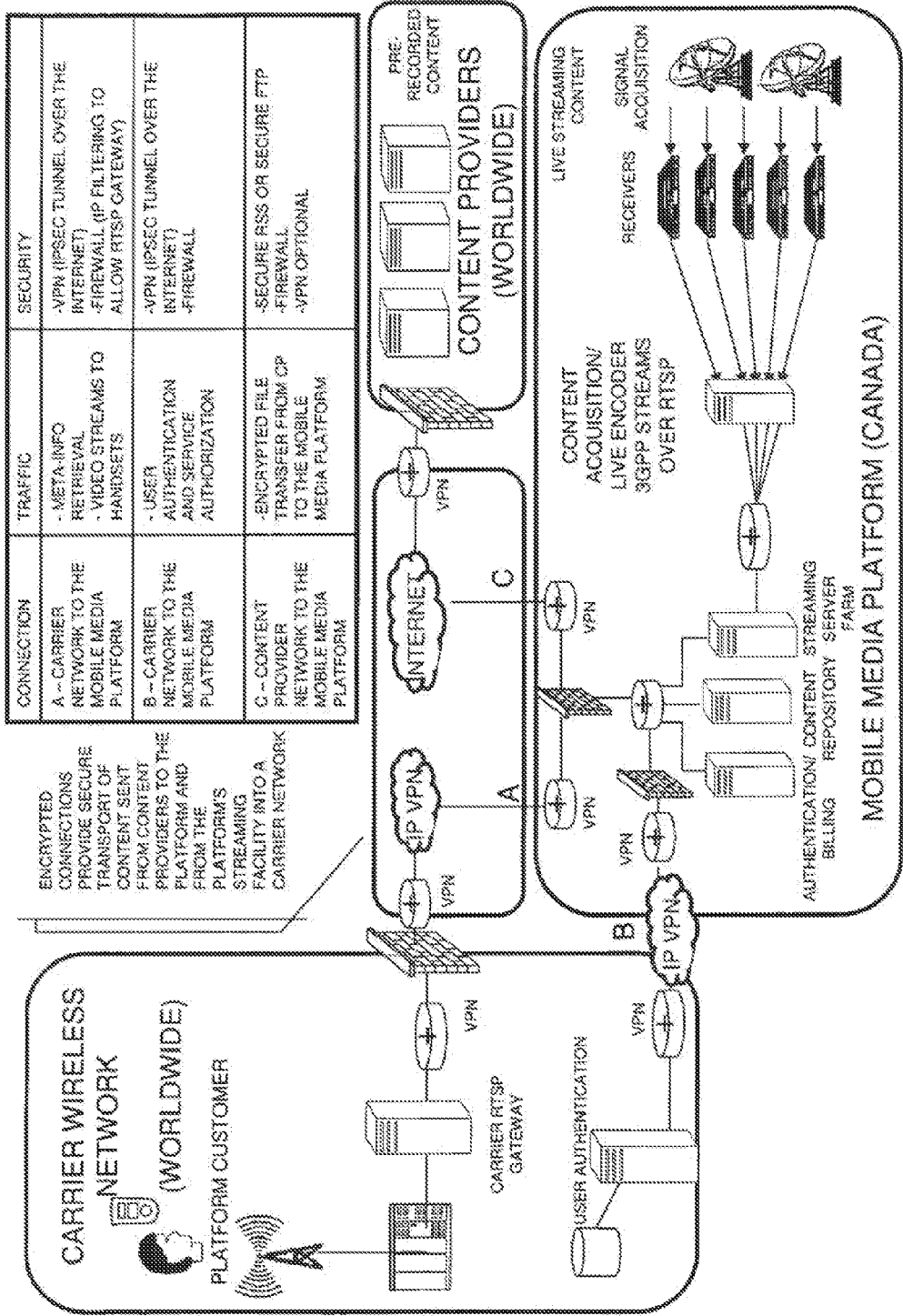

Fig. 56

CONSUMPTION PROFILE FOR MOBILE MEDIA

CROSS-REFERENCE TO RELATED APPLICATIONS

[0001] This application is a Continuation of U.S. application Ser. No. 11/956,138 entitled CONSUMPTION PROFILE FOR MOBILE MEDIA, filed Dec. 13, 2007 which is hereby incorporated by reference herein in its entirety. U.S. application Ser. No. 11/956,138 claims the benefit of the following provisional applications, each of which is hereby incorporated by reference herein in its entirety:

[0002] Ser. No. 60/889,895 MOBILE MEDIA PLATFORM, filed Feb. 14, 2007; and Ser. No. 60/869,889 MOBILE MEDIA PLATFORM, filed Dec. 13, 2006.

BACKGROUND

[0003] 1. Field

[0004] The methods and systems disclosed herein relate to digital mobile media delivery.

[0005] 2. Description of the Related Art

[0006] The proliferation of mobile devices worldwide, coupled with the launch of next-generation networks by mobile operators, has led to a dramatic increase in mobile rich media consumption. With millions of multimedia enabled mobile devices being released to market, the ability for consumers to quickly access various forms of content is changing the role of the mobile device. The invention disclosed herein may provide themed, personalized, user-centric, engaging community experiences that provide compelling interaction with all types of media content. The invention disclosed herein may bridge the divide between media companies and digital distribution channels enabling both to benefit from the mobile content universe.

SUMMARY

[0007] The invention may incorporate a multi-tenant platform which may support various types of content and multiple content providers, mobile operators and other parties within a single hosted environment. The invention may include methods and systems for optimization of content delivery, facilitating access to content on a mobile device, ingesting content, storing content and metadata in a file format optimized for use on a mobile platform, integrating multiple billing systems, enabling commerce, creating a community and the like. In this application, the term phone includes any mobile device, such as a personal digital assistant, portable gaming device, laptop computer, MP3 player, video player, GPS unit, wireless email device, pager, and the like.

[0008] In embodiments, the present invention provides a consumption profile for a mobile media platform comprising a device profile, a user profile, a network profile, an encoding profile, and a content profile.

[0009] In embodiments, the consumption profile may be updated in realtime. Further, in embodiments, the consumption profile may be updated at set intervals. The consumption profile may function as a comprehensive adapter mechanism. In embodiments, the device profile may include the technical specifications of the device.

[0010] In embodiments, the user profile may include user preferences and historical user information.

[0011] In embodiments, the network profile may include technical specifications of the network, available bandwidth and usage rules.

[0012] In embodiments, the encoding profile may include information regarding the technical specifications of encoding.

[0013] In embodiments, the content profile may include information regarding the type and source of content. The content may be web content. The channel of origination of the content may be recorded. Further, the source of a request in connection with the content may be recorded.

[0014] In embodiments, the consumption profile may specify ingestion parameters and attributes. Furthermore, the consumption profile may capture ingestion parameters and attributes. In embodiments, at least one element of the consumption profile may be contained as metadata in the same file as the corresponding content. In embodiments, metadata may be included in the same file as corresponding content may be actionable based on the consumption profile.

[0015] In embodiments, the consumption profile may impact a user interface. The user interface may be a user interface of a mobile media platform. The user interface may be a user interface of a mobile device. The consumption profile may impact the look and feel of a user interface. The consumption profile may be managed through a user interface. The user interface may be an administrative user interface. The user interface may be a user interface of a mobile media platform. Further, the user interface may be a user interface of a mobile device.

[0016] In embodiments, the consumption profile may impact content discovery. The consumption profile may impact searching. Furthermore, in embodiments, the consumption profile may impact at least one of the ranking, filtering and clustering of search results.

[0017] In embodiments, the consumption profile may impact recommendations. The consumption profile may include at least one of location information and location intelligence. At least one of location information and location intelligence may be used to target content. The content may be an advertisement.

[0018] In embodiments, the consumption profile may facilitate personalization of user experience. The mobile media platform may include a personal entertainment server and the consumption profile impacts the content presented through the server. The mobile media platform includes an interactive programming guide and the consumption profile impacts the content presented through the interactive programming guide.

[0019] In embodiments, the consumption profile may impact e-commerce, e-billing, digital rights management, or some other type impact.

[0020] In embodiments, the consumption profile may include information relating to user preferences regarding digital rights management, from reports generated by the mobile media platform, or some other type of information.

[0021] In embodiments, a consumption profile may enable integration with another system. Furthermore, in embodiments, other systems include at least one of carrier systems, content provider systems, systems of mobile devices, ad servers, Internet-based systems, web-based systems, billing systems, content delivery systems, encoding and transcoding systems, storage systems, social networking systems, hosting systems, ingestion systems, security systems, search engines, mobile search engine or some other type of systems. Further,

integration may be accomplished using at least one of hard coding, loose coupling, networking, application programming interfaces, interfaces, or some other type of integration.

[0022] In embodiments, a consumption profile may facilitate integration with other systems.

[0023] In embodiments, the consumption profile may include information relating to the architecture of the mobile media platform. The information may be at least one of information relating to the application layer, business module layer, system layer, thin client, rich client, device registry, component layer, or some other type of consumption profile.

[0024] In embodiments, the consumption profile may be associated with various users of the mobile media platform. The users may be selected from the group consisting of end users, consumers, advertisers, marketers, content providers, content owners, networks, broadcasters, media companies, mobile carriers, record companies, movie studios, regulators, mobile device designers, mobile device manufacturers, mobile device offerors, mobile service consolidators, affiliates, or some other type of users. Each user of the platform may have its own consumption profile. The consumption profile may contain information relating to various users of the platform.

[0025] In embodiments, the consumption profile may be associated with various business models of the mobile media platform. The business models may be selected from the group consisting of short code and bar code campaigns, white label, private label, subscription, per-use, pre-paid, post-paid, free trial, gifting, begging, distribution initiated on deck, distribution initiated off-deck, distribution initiated via short code, viral distribution, ad-supported models (such as bulk, per view, click-through, search keyword auction, ad media, banner ads, audio/video bumpers, splash screens, interstitials, and location based), revenue share management, content provider, mobile operator, or some other type of business model.

[0026] In embodiments, a consumption profile may be pluralized. Mobile media platform may contain many pre-configured consumption profiles. The consumption profile may take the form of a number of combinations of rules that together form the presentment and best quality of service delivery to the user.

[0027] In embodiments, a consumption profile may be selected for use through awareness of the environment. Further, the consumption profile may impact seamless switching among at least two of unicast, multicast and broadcast content.

[0028] In embodiments, the consumption profile may impact seamless switching between networks.

[0029] Furthermore, in embodiments, the consumption profile may impact advanced encoding and transcoding. The parameters and attributes of advanced encoding and transcoding may be determined by a consumption profile. The network profile may influence the parameters and attributes of advanced encoding and transcoding. The device profile may influence the parameters and attributes of advanced encoding and transcoding. Further, the user profile may influence the parameters and attributes of advanced encoding and transcoding. Furthermore, the content profile may influence the parameters and attributes of advanced encoding and transcoding. Still further, the encoding profile may influence the parameters and attributes of advanced encoding and transcoding.

[0030] In embodiments, the consumption profile may be affected by advanced encoding and transcoding. The con-

sumption profile may be affected by automated content tagging. The tags may be maintained as part of the consumption profile.

[0031] In embodiments, the consumption profile may facilitate automated content tagging. The consumption profile may be affected by pausing and resuming playback. The pause markers may be maintained as part of the consumption profile.

[0032] In embodiments, the consumption profile may facilitate mediation and settlement. The information contained in the consumption profile may be used to accomplish mediation and settlement.

[0033] In embodiments, the present invention provides a method of delivery of content on a mobile media platform, providing a consumption profile, and delivering content to a mobile device, wherein content delivery may be based at least in part on the consumption profile.

[0034] In embodiments, the consumption profile may impact the type of content delivered. Further, the consumption profile may impact the source of content delivered. Furthermore, the consumption profile may impact the method by which content is delivered.

[0035] In embodiments, the consumption profile may impact when content is delivered. The content may be an advertisement and the consumption profile enables targeted delivery of the content.

[0036] In embodiments, the present invention provides a method of optimizing delivery of content on a mobile media platform, optimizing ingestion of content based on a consumption profile, optimizing encoding of content based on a consumption profile, optimizing hosting of content based on a consumption profile, and optimizing delivery of content based on a consumption profile. Furthermore, in embodiments, the encoding may be transcoding.

[0037] In embodiments, the present invention provides a method of providing a consumption profile and mediating interaction in a social networking environment based on the consumption profile.

[0038] In embodiments, the social networking environment may include at least one of content referral, content rating, gifting, forums, gifting, buddy list management, peer-to-peer management, communities of interest, profile page, dMail, points, message boards, newsletter, shop, home, advertising, notifications, sharing content on mobile devices, or some other type of social networking environment.

[0039] In embodiments, the consumption profile may contain information regarding opting in to certain aspects of the social networking environment. Further, the consumption profile may contain information regarding opting out of certain aspects of the social networking environment.

[0040] In embodiments, the present invention provides a method of targeting advertising content on a mobile media platform providing at least one consumption profile and providing an ad fulfillment engine which targets advertising content based on the at least one consumption profile.

[0041] In embodiments, advertising content may be targeted. Further, objectives for the ad fulfillment engine may be specified. The ad fulfillment engine may determine the method of delivery of the content based on the consumption profile. Furthermore, the ad fulfillment engine may determine the timing of delivery of the content based on the consumption profile.

[0042] These and other systems, methods, objects, features, and advantages of the present invention will be appar-

ent to those skilled in the art from the following detailed description of the preferred embodiment and the drawings. All documents mentioned herein are hereby incorporated in their entirety by reference.

BRIEF DESCRIPTION OF THE FIGURES

[0043] The invention and the following detailed description of certain embodiments thereof may be understood by reference to the following figures:

- [0044] FIG. 1 depicts components that cooperate in a mobile media platform.
- [0045] FIG. 2 depicts an embodiment of a consumption profile in a mobile media platform.
- [0046] FIG. 3 depicts an alternate embodiment of the embodiment of FIG. 2.
- [0047] FIG. 4 depicts mobile media delivery mode switching.
- [0048] FIG. 5 depicts differences between unicast and multicast/broadcast delivery.
- [0049] FIG. 6 depicts a unified TV mobile media environment.
- [0050] FIG. 7 depicts data flow to support mobile media delivery mode switching.
- [0051] FIG. 8 depicts advanced encoding/transcoding.
- [0052] FIG. 9 depicts automated tagging in a mobile media platform.
- [0053] FIG. 10 depicts automated tagging with web content.
- [0054] FIG. 11 depicts automated tagging with content discovery.
- [0055] FIG. 12 depicts automated tagging with location information and intelligence.
- [0056] FIG. 13 depicts automated tagging with advertising.
- [0057] FIG. 14 depicts pause and resume in a mobile media platform.
- [0058] FIG. 15 depicts an RTSP proxy for pause and resume.
- [0059] FIG. 16 depicts mediation and settlement in a mobile media platform.
- [0060] FIG. 17 depicts data flow of mediation and settlement.
- [0061] FIG. 18 depicts live content sourcing.
- [0062] FIG. 19 depicts notification.
- [0063] FIG. 20 depicts mobile media integrated in email communications with a mobile device.
- [0064] FIG. 21 depicts an aspect of an administrator user interface.
- [0065] FIG. 22 depicts an aspect of an administrator user interface.
- [0066] FIG. 23 depicts an aspect of an administrator user interface.
- [0067] FIG. 24 depicts an aspect of an administrator user interface.
- [0068] FIG. 25 depicts an aspect of an administrator user interface.
- [0069] FIG. 26 depicts an aspect of an administrator user interface.
- [0070] FIG. 27 depicts an aspect of an administrator user interface.
- [0071] FIG. 28 depicts an aspect of an administrator user interface.
- [0072] FIG. 29 depicts an aspect of an administrator user interface.

- [0073] FIG. 30 depicts an aspect of an administrator user interface.
- [0074] FIG. 31 depicts an aspect of an administrator user interface.
- [0075] FIG. 32 depicts an aspect of an administrator user interface.
- [0076] FIG. 33 depicts an aspect of an administrator user interface.
- [0077] FIG. 34 depicts an aspect of an administrator user interface.
- [0078] FIG. 35 depicts an aspect of an administrator user interface.
- [0079] FIG. 36 depicts an aspect of an administrator user interface.
- [0080] FIG. 37 depicts an aspect of an administrator user interface.
- [0081] FIG. 38 depicts an aspect of an administrator user interface.
- [0082] FIG. 39 depicts an aspect of an administrator user interface.
- [0083] FIG. 40 depicts an aspect of an administrator user interface.
- [0084] FIG. 41 a mobile media encoding flow with meta-data files.
- [0085] FIG. 42 functional modules of a mobile media platform.
- [0086] FIG. 43 depicts mobile media distribution portals.
- [0087] FIG. 44 depicts content flow to mobile media distribution portals.
- [0088] FIG. 45 depicts advertisement fulfillment.
- [0089] FIG. 46 depicts encoding data flow.
- [0090] FIG. 47 depicts pre-encoding data flow.
- [0091] FIG. 48 depicts distributed encoding/transcoding.
- [0092] FIG. 49 depicts a user interface for pause and resume.
- [0093] FIG. 50 depicts a deployment of a mobile media platform.
- [0094] FIG. 51 depicts data flow elements of the embodiment of FIG. 50.
- [0095] FIG. 52 depicts a production flow of the embodiment of FIG. 50.
- [0096] FIG. 53 depicts a content agent sequence diagram.
- [0097] FIG. 54 depicts a block diagram of an encoding process for the embodiment of FIG. 50.
- [0098] FIG. 55 depicts a video encoding lifecycle for the embodiment of FIG. 50.
- [0099] FIG. 56 depicts a deployment of the mobile media platform across geographies.

DETAILED DESCRIPTION

[0100] The invention may incorporate a multi-tenant platform which may support multiple content providers, mobile operators and the like within a single hosted environment. The platform may integrate or include integration with multiple billing systems, such as mobile operator billing systems, third party payment processors and the like. [0101] The applications and services of the platform may be hosted in a client server infrastructure which may meet or exceed the standards that all media companies expect for protection of their assets. The platform may deliver various mixtures of entertainment information, video, audio, images, photos, and personalizable, community oriented, social networking content. The platform may include best practice digital rights management (DRM) for mobile delivery.

[0102] The platform may facilitate a short time to market for media companies and/or other content providers, enabling them to capitalize on their inventories of content assets as well as fostering new content assets that are specifically created for the mobile environment. The platform may facilitate management of content, storefront and video platform offerings as well as creation of next generation multi-platform services. The platform may operate in a shared risk, shared reward business model. The platform may enable mobile content, commerce and culture. The evolution of mobile services may mirror that of the Internet. A similar pattern is happening with mobile Internet services, but in a much more compressed time frame. The platform may facilitate and assist media companies, carriers and others navigate the mobile Internet's transition from content to commerce, and ultimately to culture.

[0103] Referring to FIG. 1, the mobile media platform 100 may include a plurality of segments, functions, and components. Segments may provide an overarching coverage of inventive concepts, and include consumption profiles 102, advanced encoding and transcoding 104, automated content tagging 108, unicast-multicast-broadcast seamless switching 110, mediation and settlement 112, pause and resume 114, and the like. Functions may represent some of the major functional groups within the mobile media platform 100, and include ingestion 118, content delivery 120, storage 122, reporting 124, and the like, where advanced encoding and transcoding 104 also may represent a major functional group within the mobile media platform 100. Components may represent some of the plurality of other functions and services available within the mobile media platform 100, and include content 128, web content 130, hosting 132, optimization 134, combining data and metadata into a single file 138, a user interface 140, notification-message-alert 142, content discovery 144, location information and location intelligence 148, social networking 150, personalization 152, e-commerce 154, rights management 158, business models 160, administration 162, advertisement 164, security 168, billing 170, integration 172, architecture 174, purchasing 178, games 180, distribution and channel applications 182, platform users 184, and the like.

[0104] A consumption profile 102 may represent an ability to automate, optimize and tailor delivery of content over a network. In an embodiment, a network may include a wireless network. A consumption profile 102 may allow for characteristics, such as device characteristics, network characteristics and the like, rules, such as operator rules and the like, user preferences and the like, location characteristics and the like, date-time characteristics, content restrictions and the like to be applied. A consumption profile 102 may allow the platform to match up content, with devices and users over the network. The consumption profile 102 may take into account static and dynamic information, as described herein. The consumption profile 102 may be used to determine the manner in which content is presented and delivered to the end user, including by impacting ingestion 118, encoding/transcoding 104, delivery, search, recommendations and personalization, including for content delivery, targeted content, including ads, as well as permissions and the like. The consumption profile 102 may interact with and be implemented within a distributed architecture. The consumption profile 102 may be used with tagging 108 and to enable snacking behavior in which the end user consumes short audio and video clip content, as well as consumption of long-form content such as full length movies and the like. In certain embodi-

ments, tagging 108 may be used to enable the snacking behavior. The consumption profile 102 may allow for optimization given limited screen real estate.

[0105] Referring to FIG. 2, a mobile media platform 100 may include a consumption profile 102 which may include a device profile 202, user profile 204, network profile 208, encoding profile 210 and content profile 212, each as described more fully herein. Referring to FIG. 3, a mobile media platform 100 may include a plurality of consumption profiles 102. As an embodiment, a consumption profile 102 may be pluralized. Many consumption profiles 102 may be pre-configured for a mobile media platform 100. A consumption profile 102 may take the form of a number of combinations of rules that together form the presentment and best quality of service delivery to the user. Through awareness of the environment, a consumption profile 102 may be selected for use.

[0106] The consumption profile 102 may encompass the encoding profile, as described herein. The consumption profile 102 may encompass the device profile 202, as described herein. The consumption profile 102 may take into account variations in input file types and supported file types. The consumption profile 102 may encompass the network profile, as described herein. The network profile 208 may include information regarding network usage rules, maximum bandwidth, IP addresses and the like. The consumption profile 102 may encompass a location profile including current and historical and future predicted location information and location intelligence 148. The consumption profile 102 may encompass current and historical and future predicted date-time and content restrictions profiles and/or information.

[0107] The consumption profile 102 may take into account and/or impact the user interface. In an embodiment, the consumption profile 102 may impact the sliders, menus, polls and the like included in the user interface 140. The consumption profile 102 may take into account location information, as described herein. The consumption profile 102 may also take into account user preferences, as described herein. The consumption profile 102 may aggregate and/or take into account any of the characteristics, factors and the like discussed herein.

[0108] A consumption profile 102 may represent an ability to automate, optimize and tailor content delivery and may be related to a device profile 202. A consumption profile 102 may reference a device profile 202, may include aspects of the device profile 202, or may include a plurality of device profiles 202. A consumption profile 102 may take into account device features that may be included in a device profile. Device features may be determined by looking at a device, such as a device connected to a network. Device features may include, without limitation, screen resolution, network support, media format support, delivery format (e.g. streaming, http, and the like), and any hardware or software aspect of the device (e.g. memory size, browser software version, and the like). A device profile, and device features may be determined from a device user agent profile xml document, such as a profile that complies with UAProf as defined by the Open Mobile Alliance. Accessing a UAProf compliant user agent profile may include receiving, from the device, a URL identifying a network location of the profile. To facilitate creating and maintaining consumption profiles 102, a registry of user agent profiles or device profiles 202 may be established by the platform for each device. A user agent profile may be combined with a unique identifier for a specific device, such as a

device serial number, to further facilitate establishing and maintaining consumption profiles 102.

[0109] The registry of device profiles 202, such as a registry of UAProf, may be structured to facilitate consumption profile 102 generation and application. The structure may include rule sets, decision trees, relational databases, and the like. The structure may provide support for application level configuring of the mobile media platform 100 to conform to a consumption profile 102. In an example, available content may require a minimum display size. The media platform may use the device profile 202 registry rule set to quickly determine if the available content may be delivered to the device. A content provider may benefit from a structured registry of device profiles 202 by identifying combinations of features that may facilitate the content provider preparing content that is readily delivered to the device. A device profile 202 component of a consumption profile 102 may be beneficial in that standardization of mobile devices may be lacking.

[0110] A consumption profile 102 may be related to a network profile. A consumption profile 102 may include one or more network profiles 208, or aspects of one or more network profiles 208 that may affect consumption by devices connected to the network. The platform may define network profile 208 aspects that may be included in the consumption profile 102. Alternatively, the platform may convert network provided profile aspects to a platform preferred format. Converting network provided profile aspects may allow the converted data to be used across a plurality of consumption profiles for devices on the network. Network profiles 208 may be different for different wireless network technologies. Consumption profiles 102 may need to reflect these differences to best utilize the network technologies. Each wireless network technology may provide different capabilities that may affect consumption by devices. Operators of networks may have preferences for which of the features and capabilities associated with a given network technology they enable through their network operations. Although a network technology may support a particular capability, the network operator may not want to provide this particular capability or may restrict the capability to certain users, such as users who pay a premium for the capability. In this regard, a consumption profile 102 may include network technologies and network operations rules as part of a network profile. Therefore a consumption profile 102 may abide by or enable enforcement of network usage rules by including the network profile. In an example, a consumption profile 102 may include requiring bandwidth sharing if the network operator or carrier indicates any one user cannot use the entire network bandwidth capability. In another example, network operators may identify maximum file size limits for files being delivered over the network. This limitation may result in a file size maximum identified in the consumption profile 102 that is smaller than that which could be sent over the network technology and smaller than the connected device could support.

[0111] A network profile 208 may communicate to a consumption profile 102 other network operator or carrier rules, preferences, and guidelines such as network preferred display resolution. A single preferred resolution may be included in a network profile 208 or a plurality of preferred resolutions may be communicated to the consumption profile 102. Bandwidth demand on a network may vary and therefore the consumption profile 102 may include parameters by which the platform may determine what portion of the bandwidth to utilize. In an example, network bandwidth available for advertise-

ments during a peak period may be limited more than during non-peak periods. The consumption profile 102 may include network peak period constraints so that media content delivery may conform to the changing constraints. In an example, a network operator may impose constraints on file size during peak periods and the platform may recognize the change in constraints from the consumption profile 102 and therefore adjust delivery accordingly.

[0112] Other factors that may be included in network profiles may also be included in or impact the consumption profile 102. These other factors may guide the fulfillment of objectives of the platform and facilitate optimal utilization of the network capabilities. In an example, cost of bandwidth may be another factor. Cost of bandwidth may be represented by cost per kilobyte of data delivered over the network. To achieve a cost objective of the platform such as the aggregate cost of bandwidth, the platform may self-limit bandwidth usage based on the cost of the bandwidth. In another example, the factor may be IP address and IP addresses for certain locations may be subject to rules that differ from those applied to other areas. The consumption profile 102 may also assist with selecting among various networks that may be available. In an embodiment, the consumption profile 102 may help with the selection among the following networks for consumption of media on a mobile device: operator cellular based, wireless broadband, wireless narrowband, short range limited bandwidth (such as BLUETOOTH) and the like.

[0113] The consumption profile 102 may represent abilities of a mobile media platform 100 that encompass various capabilities of networks and devices. The consumption profile 102 may represent a union of mobile device features and limitations with network features and limitations. The consumption profile 102 may represent an intersection of the mobile devices and the network. The consumption profile 102 may alternatively include all devices features and all network features, including device features not yet supported by the network, and network features not yet supported by the device, thereby creating a highest common feature denominator associated with platform. The highest common feature denominator may be established from a network profile, a device profile, or a combination, such as a network profile 208 and a plurality of device profiles.

[0114] A combination of a device and a network may be uniquely associated with a consumption profile 102. Such a unique combination could facilitate automatically setting the device, determining an encoding scheme, selecting or generating a consumption profile 102, and the like. The unique combination of a device and a network may further facilitate identifying the features of the combination such that the features may be automatically applied to generate a consumption profile 102. In an example, a uniquely identified device, such as may be determined by querying the device on a network, may support display features that can be associated with the network profile 208 to enable delivery of high resolution content. A consumption profile 102 may exist for this unique device/network combination. To utilize the relevant consumption profile 102, the device display features may be automatically enabled through the network and content may be managed to comply with the consumption profile 102, thereby enabling the delivery of high resolution content to the device over the network.

[0115] Automatically setting or adapting a device may be facilitated by a comprehensive adaptor mechanism that may support a variety of configurations of devices, networks, con-

tent, and the like that may be available now or in the future. A comprehensive adaptor mechanism may also identify a device on a network that may support content available for delivery, such as by matching up the aspects of the available content with relevant aspects of the device profile. Based on the results of the match-up, the comprehensive adapter mechanism may signal the device, such as through the network, to adapt the phone settings to enable receiving the available content. In an example, if content is available for delivery over a network in a specific encoding and a device on the network is identified to include features that support the encoding, the comprehensive adapter mechanism may interact with the device to enable the features that support the encoding of the available content. A beneficial match-up may be tagged **108** as a rule that represents a content profile. The rule may be provided to a device and when the device re-enters the network, the relevant features can be activated to facilitate receiving delivery of the content. Alternatively, the rule may be applied during content delivery rather than being embedded in the device. The comprehensive adapter mechanism may match up content with devices, users, locations, time of day and the like.

[0116] A consumption profile **102** may determine factors associated with delivery and presentation of content. The factors may be related to features of the mobile media platform **100**, such as ingestion. The impact of a consumption profile **102** on ingestion may include affecting what content is ingested **118**, how the content is ingested **118**, ingestion frequency, ingestion preferences, ingesting the same content from multiple sources, and the like. A content profile **212** may be generated from the consumption profile **102** that may be used as a template for content sourcing, ingestion **118**, and creation.

[0117] A consumption profile **102** may impact what content is ingested so that the platform may preferably ingest content that is compatible with the consumption profile **102**. Because the platform may only ingest content that is compatible (or can be adapted to be compatible) with currently applied consumption profiles **102**, different content may begin being ingested when a suitable consumption profile **102** is applied. A consumption profile **102** may impact how content is ingested. In an example, content ingestion may be adjusted based on the available resolution of a device associated with a consumption profile **102**. If a high resolution device connects to a network being serviced by the platform, the associated consumption profile **102** may indicate to the platform to ingest high resolution content for delivery to the device. A consumption profile **102** may impact how often content is ingested. Ingestion frequency may be based on aspects of the consumption profile **102**, such as how many concurrent devices are utilizing the consumption profile **102**. Ingestion preferences may be impacted by a consumption profile **102**. A consumption profile **102** preference for small video clips may impact the ingestion preferences so that small video clips are ingested for delivery to devices to which the consumption profile **102** is applied. Content may be available for ingestion from a plurality of sources and there may be differences among the sources that relate to consumption (e.g. resolution). A consumption profile **102** that supports high resolution may be applied when a high resolution device connects to a network serviced by the platform so content that is being ingested from a low resolution source may be complemented with the same content being ingested from a high resolution source. A consumption profile **102** could

interact with a content delivery network to instruct on the most ideal source location for delivery of the content.

[0118] Encoding and/or transcoding **104** may be impacted by a consumption profile **102**. Encoding may target a consumption profile **102** to facilitate delivery to devices to which the consumption profile **102** applies. A consumption profile **102** may manipulate the content via encoding **104** so that encoded content conforms to the consumption profile **102** content delivery requirements. A consumption profile **102** may relate encoding with content availability so that content that is not available in an encoding compliant with the consumption profile **102** may not be visible to the user. Such content may not appear in search results. Alternatively, the content may be indicated as available but not viewable through the user device. The consumption profile **102** may identify alternatives for presenting content that is not available in the applicable encoding. In an example, the consumption profile **102** may indicate that text from the content be delivered. In another example, the consumption profile **102** may indicate an alternate encoding, such as a composite type that may be partially compatible so that at least some of the content may be presented to the user. The user may be presented with an option to move to another alternate encoding **104** to view content that is incompatible with the encoding indicated by the consumption profile **102**, such as by transcoding **104** the content. The user may not notice an automatic change defined by a quality of service level policy and the like. The user may be charged an additional fee for this option. The user profile **204** that may be associated with the consumption profile **102** may include preferences or restrictions associated with such an option. These restrictions or preferences may be related to parental controls, blocking techniques, fee limits, monthly charge limits, content rating, and the like.

[0119] A content encoder **104**, such as an encoder **104** of the mobile media platform **100** may include the consumption profiles **102** to facilitate providing encoded content that meets the consumption profile **102** requirements. A method of getting an encoding **104** ready for consumption may be impacted by the consumption profile **102**. Encoding required by the consumption profile **102** may require specific tools to be applied to the content to provide the encoded format. An identification of the required tools, methods, and the like may be included in a consumption profile **102** so that an encoder may determine which tools to use.

[0120] Encoding prioritization may be impacted by consumption profiles **102** in that encoded content may be stored and forwarded to network operators so the content may be readily available when needed to be delivered. Encoding **104** may be performed on an on-demand basis based on a consumption profile **102**. The platform may determine encoding **104** required at time of request based on conditions of the device, network environment (such as type and bandwidth), decoder format available on device and the like.

[0121] A consumption profile **102** may indicate support for real time delivery so a source that provides real time encoded content may be associated with the device to facilitate delivery of real time content.

[0122] The consumption profile **102** may impact delivery. Delivery may be optimized for mobile consumption as may be determined from the consumption profile **102**. Optimizing factors may be based on a consumption profile **102** such as factors that vary for each individual application of a consumption profile **102**. Each individual application of a consump-

tion profile **102** may represent an individual usage session with factors associated with it such as location, user preferences, time of day, available network bandwidth, and the like. Other factors associated with a consumption profile **102** that affect delivery include device playback capabilities, device content delivery mechanism support, content digital rights management regime, content characteristics, and the like.

[0123] A consumption profile **102** may contain device capabilities and the device capabilities may impact delivery optimization. Device audio and video playback capabilities may require specific CODECs to facilitate optimized delivery. To optimize delivery the consumption profile **102** may identify device attributes that may vary from device to device such as screen size, color depth, memory, CPU power, content receiving methods, network support, bandwidth support and the like.

[0124] A consumption profile **102** may identify one or more delivery methods supported by the network and device to which the consumption profile **102** is being applied. Delivery methods such as streaming, download, progressive download, MMS, WAP push, and the like may be associated with an application of a consumption profile **102** and therefore may impact the method of delivery.

[0125] The consumption profile **102** may have an impact on search and recommendations. Search may be impacted in that results returned from a search may be constrained to content that may be delivered in compliance with the consumption profile **102**. One or more search terms may be automatically inserted in a user search query to automatically limit the search to compliant content. Alternatively, search results may be post filtered or ordered based on the consumption profile **102**. The consumption profile **102** may impact search and/or recommendations based on user preferences or other data that may be related to the user, a user profile, a device profile, a network provider, and the like. In an example, a search for Orioles, Cardinals and Blue Jays requested by a sports fan who may subscribe to sports content packages may be impacted by the consumption profile **102** associated with the user, so the search results are ordered and/or filtered so that results related to sports teams (e.g. BALTIMORE ORIOLES, ST. LOUIS CARDINALS, TORONTO BLUE JAYS) appear ahead of general results related to birds. The consumption profile **102** may include the additional search terms. The consumption profile **102** may include a redirection to a search engine that optimizes search results for the device and network associated with the consumption profile **102**. Recommendations, such as may be provided from a recommendation engine, may be impacted by the consumption profile **102** so that the recommendations adhere to any limitations included in the consumption profile **102**. In an example, a recommendation for viewing a presidential candidate debate may be different for a device with limited video display capability or bandwidth than for a device with high speed bandwidth. The consumption profile **102** may include guidelines, preferences, and requirements that may be provided to a recommendation engine for making recommendations.

[0126] A consumption profile **102** may be associated with tagging. Tagging may include tagging content, keywords, metadata, and the like. A tag may include a reference to one or more consumption profiles to which the tagged content complies. A consumption profile **102** may include one or more tag IDs that identify content supported by devices and networks to which the consumption profile **102** applies. Tagging **108** may be an alternate for identifying within a consumption

profile **102** each type of content that complies with the profile. A tag may combine content attributes, such as encoding **104**, resolution, and the like so that the tag can be examined to quickly determine if the content complies with the consumption profile **102**. A consumption profile **102** may include a list of valid tagging methods, such as RSS.

[0127] The consumption profile **102** may be used with tagging and to enable snacking behavior in which the end user consumes short audio and video clip content, as well as consumption of long-form content such as full length movies and the like. In certain embodiments, tagging **108** may be used to enable snacking behavior.

[0128] The consumption profile **102** may be linked to level-driven encoding **104** based on quality of service and may be linked to the user's presence and availability and preferences relating to the user's presence and availability. Level-driven encoding **104** may involve adjusting and affecting the encoding process in order to achieve certain levels or values for certain parameters. In an embodiment, a parameter may be frames per second and the resolution and sampling rate of the encoding **104** may be varied to ensure a certain minimum frames per second even during periods of network congestion or across slower regions of the network.

[0129] The consumption profile **102** may take into account file types, such as types of files that may be delivered to a device. A consumption profile **102** may include a list of supported file types that may meet one or more network or device profile **202** requirements. Alternatively, file types may be parameterized based on device profile **202** features to facilitate easy cross reference of file types to device features. A list of supported file types may facilitate determining the applicability of a newly provided file by providing a readily accessible mechanism for comparing the file type of the new file to the list of supported file types. A new file type that includes parameters that match a minimum number of parameters of supported file types may be determined to be supported and may be added to the list. In an example, a new file type that is encoded such that the encoding is not supported by networked devices associated with the consumption profile **102** may only need to be transcoded **104** to be included in the supported file type list. A file type that is not supported may require different ingestion **118** parameters or processes to be supported by the consumption profile **102**. A consumption profile **102** supported file type list may include standard file types that may be identified by their extension, such as .mp3, .wav, .mov, and the like. File types that may be supported may include, without limitation, 3GPP (MPEG4 Level 0/Level 1 and H.263 video codecs with AMR-NB, AMR-WB, AAC audio codecs)—mobile video transport format; AVI (RAW, MPEG1/2/4 and Huffman codecs)—Audio Video Interleave format; WMV/ASX/WMA (v.7, v.8., v.9)—WINDOWS Media format; M2A, M2V, M2T, M2P, M1A, M1V—MPEG1/2 streams format; MOV (Sorenson codec)—QUICKTIME video format; WAV (PCM, 16 bit, 8 bit, 8-48 kHz)—Uncompressed audio files format; AMR, MP2, MP3, AAC, AIFF, OGG—Compressed audio files format; and BMP, JPEG, GIF, PNG—Image files format. By using standard extensions, a consumption profile **102** may be configured to support all .mp3 files. Delivery protocols may include HTTP, RTSP, RTP, MMS and the like. In an alternative example, a consumption profile **102** may identify a .mp3 file as supported only when it is encoded **104** with a preferred encoding bit rate. A consumption profile **102** may impact a user interface of a device to which the consumption profile

102 is being applied. The consumption profile **102** may include user interface parameters that a device may apply to a user interface. When a consumption profile **102** is being applied to a device, the device may automatically adjust the user interface to comply with the user interface parameters of the consumption profile **102**. Parameters may impact any aspect of the user interface, such as sliders, menus, polls, screen usage, and the like.

[0130] A consumption profile **102** may include rules associated with location information about a device connected to a mobile network. Location rules included in a consumption profile **102** may facilitate taking broadcast rights into account. In an embodiment, the consumption profile **102** may enable blackout zones for a sporting event. For example, mobile devices within 60 miles of an arena may be not be permitted to receive video from a sporting event occurring in the arena, unless the event is sold out. The restriction may be enforced by the platform through transcoding so that video content or composite content that includes video of the event may be delivered without the video component. Location information in connection with a consumption profile **102** may be associated with the pause and resume functionality of the platform. In another embodiment, location information concerning another device may be used to impact the content delivered to the user's device. For example, if a user is out with his wife near dinner time, advertisements concerning nearby romantic restaurants may be delivered to the user's device. In another embodiment, proximity information may be used to delivery ads or other content, such as to promote local businesses. A consumption profile **102** may include a user preference to deliver content associated with devices within a certain proximity to the user's device. In an example, a user agreeing to meet someone for drinks may receive content, such as from public information sources, about the person when the devices are within a predetermined proximity. A business may enforce consumption profiles for devices provided to employees so that confidential information is not presented to a device that is outside a security area of the business. The consumption profile **102** may identify a plurality of security areas, such as remote offices, a home office, a headquarters, and the like.

[0131] Broadcast rights may be supported by a location based aspect of consumption profiles **102**. A user within a broadcast area may receive content from a local source when the device is determined to be within a broadcast range of the local source. In an example, a user may view a NEW YORK YANKEES game through a local affiliate in Portland Me. when the user is in the broadcast range of the affiliate. Likewise, the same user may receive the NEW YORK YANKEES game through a San Francisco affiliate when the user is in broadcast range of that affiliate. In this way, local broadcast rights may be maintained as availability of content expands.

[0132] Consumption profiles **102** may be associated with device location based technology. A consumption profile **102** associated with a user who uses a device with GPS, compass-based, or cellular based location technology may take advantage of the technology. In an example, a device with GPS based location technology may receive content based a direction of movement of the device. As a user with the device walks along a street, the consumption profile **102** may direct content gathering to acquire content related to places or people that the user may come upon located in the vicinity of the direction of the user.

[0133] Preferences, such as user preferences, may be included in a consumption profile **102**, and may facilitate the platform complying with the preferences. Applying a consumption profile **102** may result in preferences that are defined in the profile being automatically applied. Preferences that may be included in a consumption profile **102** may include user preferences, cost caps, content item fees, monthly cost cap, fee cap on bandwidth, and the like. Preferences may be automatically enforced by the platform so that cost cap preferences are carefully monitored to ensure costs are not exceeded. In an example a user may specify preferences associated with media video quality. The user may prefer high quality videos and low quality advertisements, high quality sports, medium quality news, and the like. In another example, a user preference, such as maximum download or transfer time may be configured in a consumption profile **102** and, when applied, may determine delivery method selected. If a cellular network download would exceed the preferred maximum download time, then the download may be performed through a wireless broadband connection. In an alternative embodiment, the user may be prompted and offered the option of performing the download for an extra charge or as part of an upgraded subscription. User preferences may include favorite actors, sports, sports teams, artists and the like.

[0134] A content profile **212** may be derived from a consumption profile **102**. A content profile **212** may identify aspects of content that relate to delivering content to a device to which the consumption profile **102** is being applied. Aspects of content that may be in a consumption profile **102** that may be useful in identifying content may include content type (including, without limitation, long form, short form, advertisements, talking head, sports and the like), metadata, content analysis, content tag, content ingestion process, content encoding and the like. The profile of content may be determined from one or more of the aspects described above.

[0135] A consumption profile **102** may be associated with use cases. Use cases associated with a consumption profile **102** may include a user experience with a carrier, an application, a video service model, providing content to a carrier, delivering content in any network condition, and the like. A user experience associated with a consumption profile **102** may be related to a carrier so that a user experience that is tied to a carrier may be attributed to the consumption profile **102**. Parameters associated with the carrier and included in or related to the consumption profile **102** may determine aspects of the user experience, such as user interface **140**, access to network capabilities, content availability, and the like. A user may experience unacceptable performance if a carrier has established bandwidth limitations for the user or the user's device type in a consumption profile **102** being applied by the mobile media platform **100**.

[0136] A consumption profile **102** may be associated with an application. An application may require device features that may be specified in the consumption profile **102**. Content, such as interactive content, may include one or more applications or may require one or more applications to be operating on a device to access certain features of the content. The consumption profile **102** may be adapted to include appropriate reference to applications so that content that requires the applications may be sourced and delivered to the device. A consumption profile **102** may identify applications that enable features of a device, such as broadband access. Through identification of such applications, the consumption

profile **102** may facilitate automatically configuring a device. In an example, when a device first connects to a network, the device may be queried to determine the most appropriate consumption profile **102**. The carrier may automatically configure the device through the network to support the network and delivery features associated with the consumption profile **102** to provide the best user experience while connected to the network. The carrier may apply a consumption profile **102** that provides premium features at no charge to a new user on the network, such as during a free trial period.

[0137] A consumption profile **102** may be associated with a video delivery service. A video service may utilize consumption profiles to determine a video delivery model that would comply with the consumption profile **102**. The video delivery service may utilize the consumption profile **102** to increase market share by making their video delivery service available to all uses associated with the consumption profile **102**. A consumption profile **102** may include a directory of video services that deliver video content that complies with the profile so that a user of a device to which the consumption profile **102** is being applied, may utilize the directory to select one or more video delivery services. An advantage of such an approach is the device user does not have to review video service device and network requirements when searching for and selecting a service.

[0138] A consumption profile **102** may be associated with providing content to a carrier. A carrier may need to balance user wants of always best quality and always being available. One approach to providing the best quality may be for the carrier to always apply the best consumption profile **102**. To balance availability the carrier may apply an alternate consumption profile **102** that may support adapting delivery based on network bandwidth constraints. In an example, an alternate consumption profile **102** may facilitate ensuring a video advertisement is delivered—as a high resolution video when bandwidth is available, as a low resolution video when bandwidth is limited or as a pop-up banner advertisement instead of a video when network quality is low. A banner advertisement may include text, a static image, a dynamic image, active content, and the like. A consumption profile **102** may be associated with viral sharing of content. In an embodiment, a consumption profile **102** and/or user profile **204** may include destinations and other users for sharing of content. The destinations and users may include portals, communities, friends, families, business connections and the like.

[0139] A consumption profile **102** may be associated with primitives, composites, and marketing types. The platform may be adapted to facilitate delivery of each type of primitive which may be identified by the consumption profile. The consumption profile **102** may also identify which composite form to deliver from a plurality of composite forms of content available. By determining primitive related aspects of the network and the device from the consumption profile **102**, the platform may self-select content composite form, generate or form the primitives, and deliver them to a device in a manner that is no different than accessing the content on the web.

[0140] A consumption profile **102** may be associated with tagging. Tagging **108** may include tagging content, keywords, metadata, and the like. A tag may include a reference to one or more consumption profiles to which the tagged **108** content complies. A consumption profile **102** may include one or more tag IDs that identify content supported by devices and networks to which the consumption profile **102** applies. Tagging **108** may be an alternate for identifying within a con-

sumption profile **102** each type of content that complies with the profile. A tag **108** may combine content attributes, such as encoding, resolution, and the like so that the tag can be examined to quickly determine if the content complies with the consumption profile. A consumption profile **102** may include a list of valid tagging methods, such as RSS.

[0141] A consumption profile **102** may be associated with network switching. Network switching may be seamless, may occur while delivering content, may be required to deliver content, may require minimum device features, and the like. A consumption profile **102** may include rules, guidelines, and conditions for how to deal with switching among networks. A consumption profile **102** may include associations of networks to content types to facilitate determining which network to switch to for receiving delivered content. A consumption profile **102** may indicate criteria for switching networks so that switching networks occurs seamlessly to the user. Switching from a mobile carrier network to a broadband mobile network to receive content may occur automatically based on the requirements identified in the consumption profile. The consumption profile **102** may indicate to the mobile media platform **100** the networks to which the device can be switched so that the platform may select the content source based on the network support. In an example, a device that supports both cellular and WiFi networks may be served through a consumption profile **102** that indicates the device can support both networks. The mobile media platform **100** may determine to send content over the cellular or the WiFi network based on various conditions, rules, and the like. If the mobile media platform **100** determines that the WiFi network is not acceptable due to cost, availability, and the like, then content suitable for delivery over the cellular network may be sourced and delivered to the device.

[0142] A consumption profile **102** may indicate user preferences associated with network switching. Network switching may result in charges being imposed on a user, so a user may establish preferences in the consumption profile **102** regarding network switching to adhere to a cost goal or budget. Because certain features (e.g. VoIP) may only be available by switching networks, a consumption profile **102** may indicate user preferences that impact access to the features and therefore impact network switching. A consumption profile **102** may indicate a minimum level of service quality to be provided across the supported networks. Service providers may determine the network and equipment needed to provide the minimum level of service and thereby decide to support the consumption profile.

[0143] A consumption profile **102** may indicate the network technologies supported by a device, such as cellular (GSM, GPRS, EDGE, HSDPA, UMTS, CDMA, CDMA 1x, EV-DO and the like), WiFi, WIMAX, UWB, BLUETOOTH, MEDIAFLO, DVB-H, DMB and the like.

[0144] The mobile media platform **100** may enable, include and/or be associated with a mobile content provision service that combines an on-demand unicast or multicast cellular mobile content service with a mobile broadcast content service. In an embodiment, the content may be video and television. For example, the content provided using unicast or multicast may be video content and the content provided using broadcast may be televisions, resulting in the combination of broadcast and unicast MOBILE TV services. Throughout content may be discussed as video and/or television possibly under the name MOBILE TV, but is understood to be any of the content types, from any of the content sources

and with any of the content parameters discussed herein. In addition, in certain embodiments unicast may be discussed; however, it is understood that unicast may be replaced with multicast or the like.

[0145] In this manner, a user using a mobile device may be able to switch **110** between unicast/multicast content and broadcast content, which, in certain embodiments, may correspond to switching **110** between on-demand content and broadcast television content. The broadcast content may be linear programming and/or live programming Technologies for delivering content, such as television, to mobile devices via broadcast may include MEDIAFLO, DVB-H, DMB, ISDB-T, DVB-T, DVB-SH, a cellular broadcast over an upgraded network, a separate wireless broadcast network and the like. Technologies for delivering content, such as on-demand video, to mobile devices via unicast/multicast include 3.5G cellular networks, 4G cellular networks, WIMAX, HSDPA, EV-DO, EV-DO rev A, CDMA, WIBRO, FLASH-OFDM, cellular unicast over an upgraded network, a separate wireless broadband network and the like. Delivery of content may be accomplished by sideloaded which may involve a user selecting and downloading content in a wired web session on their PC or similar device and then transferring the content to their mobile device. Delivery of content may be accomplished by downloading in off-peak hours. In an embodiment, long form content may be downloaded to a mobile device during off-peak hours when network traffic may be sufficiently low to allow increased video traffic without voice service degradation. FIG. 4 depicts a possible embodiment of this service. In this embodiment the application on the mobile device may be a MOBILE TV application and the service and application in combination may allow the user to switch between the content provided via broadcast and the content provided via unicast/multicast.

[0146] Unicast, multicast and broadcast methods, among others, may be used to enable mobile content delivery or MOBILE TV. MOBILE TV may include a service that delivers video to a mobile device. MOBILE TV may be unicast, multicast and/or broadcast. MOBILE TV may involve various user consumption methods, such as on-demand and linear programming. In an embodiment, MOBILE TV content may be delivered via a unicast network, whereby video is streamed over a cellular network in which there is a one to one relationship between the transmission source and the receiver. In an embodiment, video content may be delivered via broadcast. In a broadcast service, a single radio signal may be transmitted to a potentially infinite number of receivers. Viewers who are tuned in to a specific channel may see the same video program simultaneously.

[0147] In an embodiment, content for an on-demand service may be sourced in the form of pre-recorded clips. In an on-demand service, a user may select the content and play of the content commences from the beginning of the clip. Both broadcast and unicast MOBILE TV services may provide the ability to select content on an on-demand basis to a certain degree. In a linear programming service, a user may tune in to a channel in progress, and joins the program at the point at which the program on that channel is currently being played. Linear programming content is generally sourced from either live terrestrial TV channels and retransmitted intact over the MOBILE TV service as a simulcast or it may be constructed as a loop of a series of pre-recorded clips concatenated together to form a longer duration set of content that is repeated over time. Both broadcast and unicast MOBILE TV

services may deliver linear programming. In an embodiment, linear content may be delivered as channels over a broadcast network, and personalized, timely on-demand content may be delivered over a bi-directional one-to-one unicast cellular network. In an embodiment, the user may not notice any difference in how content is delivered. The user may have a single user interface **140** (such as an integrated TV client) on a mobile device to access all content. A unicast network may provide access to a catalogue of long-tail content, and the one-to-one nature allows for delivery of personalized, targeted content. Broadcast networks may be complementary to unicast networks: they efficiently deliver the same signal to a large number of users simultaneously, and therefore may be well-suited to delivery of short-head content, both long format and short format. In an embodiment, using a combination of unicast and broadcast networks can optimize network capacity and investments.

[0148] FIG. 5 depicts a possible programming line-up for a combined unicast and broadcast service. Traditional multi-channel video services with base and premium tiers may be delivered over the broadcast network, providing the majority of the short-head content. Extended video services provide long-tail content from niche producers and user-generated content possibly through a video on demand service that includes clips and niche linear channels not provided via the broadcast portion of the service. This programming line-up may reflect an on-deck vs. off-deck strategy, in which on-deck content is limited to only the most popular content (such as short-head content), while the long-tail content can be managed and delivered without the operator's involvement. In an embodiment, the content may be audio content. For example, broadcast audio content may be radio and unicast content may be particular songs, interviews or radio programs. In an embodiment, the content may be data. In an embodiment, the content may be data as part of a datacasting service for traffic, weather, emergency info and the like. In an embodiment, the content may be clips. For example, a clip-casting service may push a small set of video clips to a mobile device for subsequent viewing on demand. In an embodiment, network technologies may include point-to-point cellular, cellular broadcast, mobile broadband, mobile broadcast technologies and the like.

[0149] In a certain embodiment, a user watching a mobile broadcast of a linear live sporting event program is provided with a link to view pre-recorded 5 minute video clip of an interview with the player who just scored a goal. The video of the interview would be served up on-demand over the cellular network when the user clicked the link. After viewing the clip, the user could be provided other links to allow them to choose from a list of other content that is available on either the broadcast or cellular networks, or the user could choose to resume viewing the original broadcast. In this way, the "short-head" broadcast content can be used as a driver for users to discover "long-tail" on-demand content, and vice-versa.

[0150] MOBILE TV may also provide and/or be associated with browsing, recommendation and search functionality for on-demand pre-recorded clips and broadcast TV to allow for discovery of current and upcoming broadcast programming. This functionality may also extend to any content, including content that has been recorded on a home or network-based PVR or the phone's PVR. The platform may include and/or enable PVR-like capabilities in which the broadcast content is buffered on the device so that the user can choose to resume viewing where they left off, or go back to the program in

progress. In an embodiment, the service may allow picture-in-picture display where the on-demand clip and the live game are on the screen at the same time, and the user can switch between the two via a single click.

[0151] In an embodiment, a user interface for MOBILE TV may be presented through a unified MOBILE TV client application on a mobile device. The client may be enabled by server-side functionality provided by the platform. The user interface **140** may include an EPG similar to the traditional grid of linear TV, or it may be less linear and similar to a streaming content portal. The user interface **140** would allow a user to seamlessly move between content via broadcast and via unicast without a noticeable change in the user experience. The user may be able to directly browse and select linear and on-demand content.

[0152] In an embodiment, the mobile content provision service may provide recommendations for other associated content that encompasses both the broadcast and unicast content universes. A user will be able to personalize their experience by setting preferences that include favorite linear channels and programs, favorite on-demand categories, favorite genres, areas of interest, notification settings and the like. The service may deliver targeted ads to the user based on a number of factors, including the consumption profile, their demographic info, their preferences, their location, location intelligence, usage history, operator and device type. In an embodiment, ads may be delivered as clips for inclusion as interstitials. Delivery could be via unicast, allowing very specific targeting, or with less granularity via the clipcast/datacast mechanism of broadcast networks.

[0153] In an embodiment the service may provide targeted links to allow the user to browse to sites related to the content being viewed. In embodiments, the links may allow users to purchase related content or goods and services via operator or third party storefronts. In embodiments, the service may include community interaction functionality, such as recommend to a friend, send to a friend, user rating and the like. In embodiments the service may include content localization functionality to facilitate restriction of delivery of content to specific areas. For example, local news and weather reports, targeted ads based on location, as well as for implementing content blackouts of broadcast programming. Content search and discovery may span across unicast and broadcast content, facilitated using metadata. In embodiments, the service may also include protection controls which may control access to content. This functionality may grant or restrict access to certain services based on specified criteria. In an example, a user may be granted access to a particular channel or category for a specified period of time based on the amount of content the user purchased. Content protection may also apply to usage rights that are applied after the content has been delivered and determine how a piece of content may be used according to specified conditions and constraints.

[0154] FIG. 6 depicts a general implementation of a specific embodiment of a combined unicast and broadcast service. It is understood that this is only one specific embodiment and that other implementations are possible. All connections and arrows in the figure may flow both ways and elements may be connected even though not depicted in the figure. FIG. 7 depicts another general implementation of a specific embodiment of a combined unicast and broadcast service. It is understood that this is only one specific embodiment and that other implementations are possible. All connections and arrows in the figure may flow both ways and

elements may be connected even though not depicted in the figure. In this embodiment, the on-demand service delivery platform may manage the on-demand content, ingest the content, and perform encoding and transcoding. In this embodiment, the unified MOBILE TV service delivery platform may perform the unified EPG, broadcast/on-demand synchronization, cross-promotion, content targeting, ad targeting, device management, content localization, preference management, discovery, recommendation, personalization, DRM enforcement, pricing, service bundling, billing integration, subscription management, authentication, authorization, accounting functionality and the like.

[0155] The platform may contain an application that combines on-demand delivery of video over a cellular network with live television broadcast content that is delivered over a mobile broadcast technology, such as DVB-H, DMB, MEDIAFLO or the like, together into a single user experience. In one embodiment, a user watching a mobile broadcast of a sporting event may be provided a link to view a pre-recorded video clip that covers the highlights of the game to that point. Clicking the link may result in the application switching video delivery sources from the mobile broadcast network to the cellular network and causing the highlighted video clip to be streamed on-demand to the user via the cellular network. After viewing the clip, the users could be provided other links to allow them to choose from a list of other content that is available on either the broadcast or cellular networks. In another embodiment, the application may simultaneously source content from various networks and/or external repositories and integrate the data from these various sources in order to provide the user with a high quality experience. Additionally, the content sourced from various networks and/or integrated repositories may be related to the interests, whether accumulated or point in time, of the user. This may reduce or remove a need to search on the mobile handset. This process may result in effectively increased bandwidth.

[0156] Advanced encoding and/or transcoding **104** may be based on architecture that facilitates supporting real-time encoding and/or transcoding **104** of content while also supporting cost effective and space efficient encoding and cataloguing of content for later retrieval by a mobile device **802**. A mobile media platform **100** may be associated with advanced encoding and/or transcoding **104** by at least aspects of the encoding/transcoding **104** architecture. An advanced encoding and/or transcoding **104** architecture may include pipelining and parallel operation of certain features to reduce encoding latency. A pipeline operation may allow content to be serially loaded into a first encoding stage while each subsequent encoding stage may receive a first output of the first encoding stage while subsequent content is serially loaded into the first encoding stage. The process may be repeated for a third and a fourth encoding stage so that latency from when the first content is serially loaded into the first encoding stage to the first content being serially delivered out of the last encoding stage is minimized. An advanced encoding/transcoding **104** architecture may also support on-the-fly encoding wherein content is encoded using one or more encoders with different encoding schemes when it is either presented to the platform or when it is accessed within the platform for delivery to end user. Architecture techniques such as

caching may also facilitate reduced latency and therefore may improve user perception of a mobile media platform **100**.

[0157] The platform may be associated with an advanced encoding/facility **104**. The advanced encoding/transcoding facility **104** may include ingestion **118** of external content. Ingestion **118** may be automatic; it may be self-aware ingestion **118**; it may include encoding **104**; it may include tagging **108**; and it may include various combinations, such as automatic ingestion **118** and encoding **104**.

[0158] An advanced encoding/transcoding facility **104** may manage content that has been ingested by a self-aware ingestion module **118**. The self-aware ingestion module **118** may perform ingestion **118** automatically for any content type and for any content format. Self-aware ingestion **118** may bring content into the platform in a format that is useable by the platform such as QAR format or RSS feed format. The self-aware ingestion module **118** may be part of the advanced encoding/transcoding facility **104** or it may communicate with the advanced encoding/transcoding facility **104** to deliver content to be managed. Self-aware ingestion **118** may facilitate normalizing content so that content from any type and any format may be normalized, such as through recoding and format conversion, into a format useable by the platform and/or the advanced encoding/transcoding facility **104**. Encoding, recoding, and transcoding **104** may be performed by the self-aware ingestion module **118**. Alternatively, the self-aware ingestion **118** capability may be an attachment to an encoding process of the platform so that ingestion **118** and encoding **104** may be operated under separate constraints.

[0159] A self-aware ingestion **118** process may function as a web service or may function analogously to a web service. It may include encoding **104** and/or publishing capabilities, or may enable such capabilities in the platform based on the availability of content. In an example, a self-aware ingestion **118** module may automatically act on new content when new content is available such as through a content feed, search capability, content posting, and the like.

[0160] A self-aware ingestion **118** process may determine automatically how to act on any content. Self-aware ingestion **118** may be performed based on the content, metadata associated with the content, aspects of the content source, encoding **104** of the content, format of the content, attachments to the content, and the like. Self-aware ingestion **118** may determine what encoding, recoding, transcoding **104**, format conversion, filtering, and the like is needed based on ingestion **118** parameters associated with the advanced encoding/transcoding facility **104** and/or the platform. In an example, a self-aware ingestion **118** module may compare the encoding of newly presented content to a representation of encoding supported by the advanced encoding/transcoding facility **104**. If the newly presented content is in an encoding that is supported by the advanced encoding/transcoding facility **104**, then no recoding may be performed. If the newly presented content is in an encoding that is not supported, the self-aware ingestion **118** module may order recoding from an attached encoding facility before directing the content to the advanced encoding/transcoding facility **104**. In another example, a self-aware ingestion **118** module may determine that a transcoding process exists to recode newly presented content from its presented encoding to a preferred encoding. In such a situation, the self-aware ingestion **118** module may perform the transcoding to present the content in the preferred encoding.

[0161] An advanced encoding/transcoding facility **104** may perform self-aware ingestion **118** based on a trigger, such as content being deposited into a location known to the advanced encoding/transcoding facility **104**. A location may include a directory, an FTP site, an RSS feed indicating new content, an email received with the content or with a link to the content, an email with an attachment containing the content, an address (URL, port, and the like) to which content is streamed, an address (URL, port, and the like) to which a notice of content availability is sent, an external scheduler that may be linked to a guide such as TV guide, and the like. A location may be location external to the platform, may be internal, or may be a handoff between modules of the platform, such as between the advanced encoding/transcoding facility **104** and the self-aware ingestion **118** module.

[0162] Self-aware ingestion **118** may be performed on externally supplied or discovered content, or it may be performed on content already known and/or managed by the advanced encoding/transcoding facility **104**. In an example, the advanced encoding/transcoding facility **104** may manage content that is stored in an encoding that is not compatible with a device to which the advanced encoding/transcoding facility **104** desires to publish the content. The advanced encoding/transcoding facility **104** may signal the self-aware ingestion **118** module to retrieve the content and take any action necessary to prepare it for compatible publication to the device. The self-aware ingestion **118** process may determine what encoding is present, what encoding is desired, what transcoding is necessary, and may perform or direct an encoding facility to perform the action.

[0163] Referring to FIG. 8, advanced encoding/transcoding may encompass an encoding architecture **804**, encoding formats **808**, encoding profiles **210**, dynamic encoding **104**, self aware ingestion **118**. Advanced encoding/transcoding **104** may also relate to advertising **164**, location intelligence **148**, consumption profiles **102**, content discovery **144**, tags **108**, content profiles **212**, distribution **182**, and devices **802**.

[0164] Self aware ingestion **118** may use an encoding profile **210** to determine what action to take on content that it is aware of. Actions associated with self-aware ingestion **118** may be based on device characteristics **802** such as device players, codecs, device screen size, display color depth, pixel resolution, device memory size, device processing power, and the like. Actions associated with self-aware ingestion **118** may be based on characteristics associated with a network through which the device and the platform communicate, such as network type, network speed, network bandwidth available for delivery of the content, and the like. Similarly, self-aware ingestion **118** may be based on device operator characteristics that may include content use rules, policies, bandwidth restrictions, content restrictions, and the like. Content characteristics may at least partially determine what actions may be associated with ingesting content by a self-aware ingestion **118** module. An example of content characteristics that may impact self-aware ingestion **118** is content motion type. Ingestion **118** of talking head type content may be performed by a self-aware ingestion **118** module very differently from ingestion **118** of live action, sports, movies, advertisements, and the like. To perform ingestion **118** of talking head content may require less processing power, and therefore may reduce communication bandwidth. A self-aware ingestion **118** module may signal system resources accordingly such as to optimize system resource utilization.

[0165] Aspects of a delivery method associated with the content may also determine what actions and resources a self-aware ingestion 118 module requires for ingestion 118 of the content. Delivery methods may be based on content type because delivery methods may be different for a live linear source than for a clip linear source. Additionally live linear delivery may be broadcast type delivery, unicast type delivery, multicast type delivery, and the like. Clip linear delivery may be based on a unicast type delivery. If the intention is to store the content, such as in a database associated with the platform, and deliver the content at a future scheduled time, the self-aware ingestion 118 module may take actions to ingest the content into storage at this time and take additional actions to retrieve the stored content and ingest it using other actions for delivery at the delivery time. In this way encoding profile 210 factors that take into account static and dynamic factors may be used by enhanced encoding/transcoding 104 and self-aware ingesting 118 processes.

[0166] Enhanced encoding/transcoding 104 may also be associated with self-aware encoding and/or transcoding of content, such as video content. Similarly to self-aware ingestion 118, self-aware encoding/transcoding 104 may be automatic. Automatic self-aware encoding/transcoding 104 may be based at least in part on a consumption profile 102 as herein described. Automatic self-aware encoding/transcoding 104 may be based on content availability, aspects of the available content, acquisition of the content, mobile device 802 acceptance and/or support of tagging format, tagging 108 related to the content or metadata associated with the content, and the like. A self-aware encoding/transcoding 104 capability may impact content acquisition and detection. A content manager with self-aware encoding/transcoding 104 capability may acquire or detect content in a wide variety of formats and types that may be readily transcoded by the self-aware encoding/transcoding module.

[0167] A selection of carrier rules may be impacted by self-aware encoding/transcoding 104. Similarly, self-aware encoding/transcoding 104 may be impacted by a selection of carrier rules.

[0168] Other benefits of self-aware encoding/transcoding 104 include content links can be syndicated such as an RSS feed, and content may be composite content. Based on attributes of the composite content, a self-aware encoding/transcoding 104 module may select one or more of encode, transcode, deliver, and the like when presented with composite content.

[0169] Self-aware encoding/transcoding 104 may transcode and deliver on demand, removing the need to have storage of multiple encoded versions of a file, saving on disk storage. Delivery formats may be based on what the requesting client supports.

[0170] Self-aware encoding/transcoding 104 may provide benefits when used with time sensitive content and may be based on the time sensitivity of the content. In an example, breaking news may be immediately encoded, whereas other news reports may be encoded only when encoding bandwidth is available.

[0171] Self-aware encoding/transcoding 104 may also facilitate optimization of ingestion 118. Encoding may be time shifted or prioritized to optimize aspects of ingestion 118 such as bandwidth, processing power, detection, acquisition, and the like. Self-aware encoding/transcoding 104 may also facilitate managing and/or prioritizing actions over

multiple CPUs. Such adjustments associated with self-aware encoding/transcoding may be performed automatically.

[0172] Self-aware encoding/transcoding 104 may be based on a schedule. The schedule may be an ingestion 118 schedule. In an example, ingestion 118 may be performed as content is available, but encoding/transcoding 104 may be performed on the ingested content based on a schedule for encoding. A self-aware encoding/transcoding 104 schedule may be based on resource utilization, carrier demand, and the like. The encoding/transcoding 104 may be scheduled across multiple CPUs.

[0173] Enhanced encoding/transcoding 104 associated with self-aware encoding/transcoding 104 may also be associated with job management. Automatic actions, which may be considered natural actions of a self-aware encoding/transcoding 104 process, may be based on content type. Through job management, encoding/transcoding 104 may be scalable to support greater throughput, faster response time, higher complexity of content, more sophisticated transcoding 104, and the like. Job management may be combined with a scheduler to further improve encoding/transcoding 104 associated with a self-aware encoder. Encoding job management may also provide benefits associated with distributed computing, such as workflow processing. An encoding job may be managed so that various computing facilities may act on the content as it flows through a workflow associated with the job. Workflows may include various aspects of enhanced encoding/transcoding 104 including elements ranging from content creation through ingestion 118 and distribution 182. Workflows may also be represented graphically, such as with a process graph and may incorporate user specified parameters. Workflows may embody constraints associated with ingestion 118 optimization, resource utilization, encoding preferences, and the like that a self-aware encoding/transcoding 104 module may access to process content through workflows.

[0174] Content profiles 212 may also be used by a self-aware encoding/transcoding facility 104 to determine a type of content and therefore determine what actions to take. Content profiles 212 may identify aspects of content that a self-aware encoding/transcoding facility 104 may analyze, such as metadata, content type (e.g. talking head vs. live action), content tags 108 and the like.

[0175] Self-aware encoding/transcoding 104 may also be characterized by taking consumption profile 102 factors into account. Consumption profile 102 factors such as network characteristics, features, and capabilities; device characteristics 802, features, and capabilities; and user preferences, and the like may be considered. In an example, user preferences associated with video quality may be considered such that encoding/transcoding 104 ensures that video is encoded to provide high quality rendering, whereas advertisement 164 may be encoded to only support low quality rendering. Sports may be encoded for high quality while movies may be encoded for medium quality to satisfy display requirements, user preferences and balance network, other resource requirements and the like.

[0176] Encoding actions associated with a self-aware encoding/transcoding facility 104 may be directed toward the network. In embodiments, encoding actions may be optimized for network and operator characteristics, including network speed, bandwidth and other factors described herein. In an embodiment, content may be pre-encoded for shifting between network speeds, such as to EVDO and 1x and back.

The mobile media platform **100** may, generally, be associated with encoding and transcoding **104**. In particular, content ingestion **118** may include various encoding and transcoding **104** features and capabilities as herein described. The following is an overview of various aspects of encoding/transcoding **104** that are described in association with various other aspects of the invention elsewhere herein. Encoding may be performed for a distribution **182** network type, for a device type, for a delivery method, may support various encoding formats **808**, may be embodied variously, and the like.

[0177] Encoding for a distribution **182** network type may include optimizing for network and operator (e.g. wireless service provider) characteristics or requirements such as network speed and bandwidth (e.g. dynamic based on time of day), or pre-encoding to facilitate shifting between various speed networks (e.g. EVDO to 1x, 1x to EVDO, and the like) that may be encountered throughout the distribution **182** network.

[0178] Encoding actions associated with a self-aware encoding/transcoding facility **104** may be directed toward the device. Encoding for device aspects **802** may include consideration of screen size, content type, video quality (such as corresponding to talking head, sports, music videos and the like), audio capabilities (such as corresponding to the human voice, music and the like), color depth, audio/video synchronization, file type, device memory, CPU, device processing power or type, operating system, and the like. In an example a device may be suited for human voice audio output (e.g. a basic mobile phone), so that audio encoding of high fidelity music may be adjusted to gain the best quality of sound from the device. Encoding for a device may include encoding based on a device attribute such as screen size, color depth, memory, CPU, operating system, and the like. Device targeted encoding may be based on an association of content with the device type. Device encoding may be based on video type (e.g. talking head, sports, music video, advertisement, document), audio type (e.g. human voice, music), device file type, and the like.

[0179] Self-aware encoding/transcoding **104** may be directed toward encoding for a delivery method. Delivery methods such as streaming, download, progressive download, MMS, WAP push, and the like may each impact encoding in different ways. A self-aware encoding facility may adjust encoding based on the delivery method.

[0180] Encoding, and in particular self-aware encoding/transcoding **104** may support a variety of encoding and content formats. A self-aware encoding/transcoding **104** module may support one or more of these formats: 3GPP (MPEG4 Level 0/Level 1 and H.263 video codecs with AMRNB, AMRWB, AAC, ACC+ audio codecs)—mobile video transport format; H.264, AVI (RAW, MPEG1/2/4 and Huffman codecs)—Audio Video Interleave format; WMV/ASX/WMA (v.7, v.8., v.9)—WINDOWS Media format; M2A, M2V, M2T, M2P, M1A, M1V—MPEG1/2 streams format; MOV (Sorenson codec)—QUICKTIME video format; WAV (PCM, 16 bit, 8 bit, 848 kHz)—Uncompressed audio files format; AMR, MP2, MP3, AAC, AIFF, OGG—Compressed audio files format; BMP, JPEG, GIF, PNG—Image files format; and the like.

[0181] A self-aware encoding/transcoding facility **104** may be embodied as a MEncoder, an FFmpeg encoder, an MP4Box encoder, and the like.

[0182] Enhanced encoding/transcoding **104** may be associated with automated ingestion **118** in combination with

encoding. Automated ingestion **118** and encoding may facilitate detecting and acquiring content from sources of various quality. Automated ingestion **118** and encoding may facilitate acquiring, tagging, encoding, and packaging any digital format content for distribution **182** to any mobile device **802**. Acquiring content may be done through polling third party sites for content. The various third party sites may contain widely varying content formats that may be readily supported by automated ingestion **118** and encoding. Formats such as video, audio, images, text, and the like are examples of content that may be managed by automated ingestion **118** and encoding methods. Content may be submitted or obtained for automatic ingestion **118** and encoding via an interactive web portal, an FTP upload (push or pull), a Web Service API, and the like.

[0183] Encoding may be embodied in one or more encoding architectures **804**, such as a flexible content encoding system that provides identical (but automated) ingestion **118** capability to the mobile media platform **100**, but is extensible and scalable for the future. It may be built upon a modular component system that leverages a tree-like data structure and a normalized object model to provide consistent interfaces across many services such as collection, encoding, validation, and publication.

[0184] Automated ingestion **118** and encoding may be based on a scalable architecture **804** that enables handling a broadening number of incoming content clips and producing an even broader number of uniquely encoded clips for delivery. Automated ingestion **118** and encoding may reference device profiles, network profiles, consumption profiles **102**, content profiles **212**, and the like to identify and execute ingestion **118** and encoding actions.

[0185] Encoding may be a part of ingestion **118** or may be done separately. Encoding may be based on criteria that are unrelated to ingestion **118**. Automated ingestion **118** combined with automated encoding may open or create new standard acquisition methods. It may also facilitate repurposing non-mobile ready content for mobile use thereby turning the non-mobile content into a more valuable digital asset.

[0186] A mobile media platform **100** associated with automatic ingestion **118** and encoding may relate to existing standards such as RSS. Automatic ingestion **118** and encoding may be compatible with existing standards. Methods and actions associated with or resulting from automatic ingestion **118** and encoding may provide material that may be added to standards, such as acquisition focused standards. Standards may facilitate content generation being acquisition friendly/focused. However, an automatic encoding/transcoding **104** process that supports diverse content formats and types may impose no new minimum constraints on content providers while offering opportunities to enhance standards related to content generation, encoding, delivery, and use.

[0187] A mobile media platform **100** associated with automatic ingestion **118** and encoding may work beneficially with a standard such as RSS. The platform may provide methodologies and/or tags **108** for using RSS to feed content based on consumption profiles **102**, content profiles **212**, device profiles, user profiles, and the like. Consumption profiles **102** and the like may be useful in defining content to be acquired. Attributes related to profiles may be added to content generation and delivery on top of any attributes or specifications associated with using RSS. Such attributes may enable content providers to direct content by making the generated content RSS feedable to mobile user.

[0188] RSS may also facilitate using tags 108 to enable auto ingestion 118 and encoding. RSS tags 108 may be related to publishing. Tags 108 may also be related to content lifecycle. Ingestion 118 may consider tags 108 related to content lifecycle to determine, for example, how long content has been available. Other actions associated with content lifecycle tags 108 may include when to stalemate it, when to publish it, when it was published, when to remove it, when to delete it, when to archive it and the like. Tags 108 may be used during ingestion 118 and encoding and/or may be passed through ingestion 118 and encoding to be used by down stream resources. In an example, a tag associated with content lifecycle may be passed through ingestion 118 and may be stored in association with the ingested content. At a subsequent encoding activity, such as a scheduled encoding activity, the content lifecycle tag may be used to determine what actions to take. If the content lifecycle tag indicates the content is no longer valid (e.g. it may be past an expiration date/time), the content may not be encoded.

[0189] RSS may facilitate device profiling in association with automated ingestion 118 and encoding. Using RSS features may allow the mobile media platform 100 to facilitate directing content to specific device types 802. The mobile media platform 100 may take advantage of existing content definition and may allow an expansion of RSS standards to apply to content primitives.

[0190] Automated ingestion 118 and encoding may support composite content through enabling encoding directed toward each portion of the composite content. In an example, news content may be a form of composite content in that it may include images, text, video, audio, all of which may be synchronized. Because news content may need to be delivered to a device that may have capabilities that affect each composite content type, encoding for text may require an encoding process that delivers encoded text that is targeted to the device and may be different than the encoding that delivers video targeted to the device capabilities. A mobile media platform 100 may be capable of expanding composite content support, such as to support further composite attributes. In an example, a mobile media platform 100 may use primitives to extract more benefit from composite content types, such as in the ingestion 118 and encoding processes.

[0191] On-demand encoding and transcoding 104 may be associated with the mobile media platform 100. On-demand encoding and transcoding 104 may be used with live linear, audio and video clips, large content databases with small disproportionate usage, and the like. Pre-encoding content with small usage may not utilize the platform resources for storing encoded content efficiently or cost effectively so such content may be sourced and encoded/transcoded on-demand. ON-demand encoding and/or transcoding 104 may be used to deliver the content to the user device as well as generate a pre-encoded version to be stored for later access. On-demand encoding may be useful for large content libraries and remote sources. Generally on-demand may provide at least medium quality output using a single pass encoder. Generic encoding may efficiently performed by on-demand encoding/transcoding 104. A hardware architecture 804 for on-demand encoding may yield very high performance with minimal latency. Such an architecture 804 may be readily scaled through a server based, modular computing environment that may support a high degree of encoding concurrency. Low and moderate content access frequency or high and sporadic requests may be handled by on-demand encoding.

[0192] ON-demand encoding allows the platform to rely on the content source server to host the content. In an example, a user may direct a request (e.g. search) for content to the mobile media platform 100 that causes the platform to gather the content from the content host server storage, ingest, encode, and deliver the content to the user device. Example of hosts may include AOL, YOUTUBE, news sites, TV and broadcast cable sites, and the like. Another example involves creating an application that directly interacts with a content provider's website (e.g. AOL) to present a mobile version of the content provider's site. A user would browse, search, and display details of the content provider's assets directly from the website, but would request the content through the mobile media platform 100. The platform would obtain, transcode, and cache the requested content from the content provider site whilst feeding the mobile device 802 through a live or cached stream.

[0193] On-demand encoding may be used with raw content that is stored (e.g. hosted) on the mobile media platform 100 (e.g. encoding host) instead of content stored on a content source host server. In another example, a content provider, such as AOL would bulk download content to establish a base of content that may be encoded on-demand. Updates and additions to the available content would be downloaded as it becomes available. The mobile media platform 100 may encode the downloaded content and host it locally, making it available to all platform services (e.g. search, personalization, and the like). An on-demand encoding mechanism would further reduce the latency between the time new content is downloaded from AOL, and the time it is available for distribution 182.

[0194] Pre-encoding of content may be beneficially applied in a mobile media platform 100 content serving environment. Content may be encoded into popular encodings, such as encodings based on consumption profiles 102 of users currently connected to the network or currently requesting various content to be encoded. Pre-encoding facilitates easier and more rapid response to requests for content. However, pre-encoding usually entails several sequential steps. These steps may perform multi-pass encoding that increases the quality substantially over single-pass encoding. The time to encode may depend on the load, quality, processing requirements, and the like, but may be slower than needed to support real-time encoding. In an embodiment of multi-pass sequential encoding, outputs of a previous encoder are daisy-chained to the inputs of a next encoder resulting in a delay before the encoded file is available for consumption. To reduce latency associated with sequential encoding, while achieving equivalently high quality, successive encoding stages may be configured in a pipeline such that the output of a first encoder is fed to the input of a second, so that encoding in each encoder is off set by a small amount of time, allowing most of the encoding to be run in parallel. The total latency may then approximate the sum of the latencies of each encoder from the first block read in to the first block written out. The total latency may readily facilitate real-time multi-pass encoding. To yet further improve latency from content access to consumption, a live linear encoding may be run in parallel with the multi-pass encoding to allow the content to be available through the live linear encoder even before the entire content is pre-encoded. Once the entire content is pre-encoded, subsequent requests for the content can be delivered from the higher quality pre-encoded content. Pre-encoding may consume greater computing resources than single pass live on-

demand encoding so the platform may queue up pre-encoding jobs and allocate off-peak time for executing the jobs, thereby reserving computing power during peak time to on-demand encoding.

[0195] Pre-encoding may be used for small to moderate sized content libraries. Pre-encoding may result in high quality and high resolution encoding using a multi-pass encoding method. Although a hardware architecture 804 can support pre-encoding, it may be efficiently performed by a general purpose processing environment using software encoding algorithms. Pre-encoding may improve mobile media platform 100 resource utilization for high demand content. A pre-encoding method may scale through a model based on resource prioritization, bulk encoding, regular scheduled encoding, and the like.

[0196] On-demand encoding may further facilitate in-stream ad insertion for live linear feeds. Delivery of encoded live linear feeds may be switched to advertisement feeds while the live linear feed continues to be ingested 118, encoded 104, and cached for delivery at the completion of the advertisement delivery. Encoding methods may be combined during a consumption session so that delivery may be separated from encoding method. In an example, live linear content may be encoded on-demand and pre-encoded advertisements may be inserted in the delivery stream.

[0197] Advanced encoding/transcoding 104 may facilitate distribution 182 of live linear content with targeted advertisements by distributing a plurality of streams, each with its own advertisement sourcing criteria and in-stream ads, to individual users in a unicast distribution 182 or to groups of users in a multi-cast distribution 182. A single live linear creative content feed may be replicated through encoding and transcoding 104 into the plurality of delivery streams.

[0198] Live linear encoding may be beneficially applied to live content feeds such as live events, news, and the like. A hardware architecture 804 may be well suited to deliver live linear encoding due to the high input rate. An architecture 804 for live linear encoding may be server based and therefore may scale well through distributed and parallel processing. A single live feed may be ingested by a plurality of encoding facilities and each encoding facility may deliver encoded content through unicast and multicast distribution 182.

[0199] A mobile media platform 100 may be associated with content related tagging 108, as shown in FIG. 9. Content related tagging 108 may include tagging 108 of content 108A, metadata tagging 108B associated with content, content container tagging 108C, profile tagging 108D such as consumption profiles 108E, device profiles 108F, user profiles 108G, content profiles 108H, and the like, and may be associated with delivery of content to mobile communications facilities 802. Tagging 108 of content may be performed by a mobile media platform 100, such as by an advanced encoding/transcoding facility 104, a self-aware ingestion facility 118, a self-aware encoding facility 104, a distribution facility 182, a delivery facility 120, a content database 122, and the like. Tagging 108 may be automated. Tagging 108 may facilitate using rules associated with ingestion 118 to setup encoding 104 and delivery 120. Tagging 108 may be used to propagate information related to content from one aspect of a mobile media platform 100 to another aspect of the platform, to a device, to a carrier, to a network, to a content storage facility, to a delivery medium, and the like. Tags 108 may be provided through a syndication feed medium such as may be defined by RSS. In an example, tags 108 associated with the mobile

media platform 100 may be provided to a community through RSS. The tags 108 and their associated definitions, values, interpretations, and the like may be included in an RSS specification. Tags 108 may be used by a mobile media platform 100 to help define the end results of enhanced encoding/transcoding 104 and other content management functions. In an example, a device or the mobile media platform 100 may poll a source of content based on tags 108 associated with the mobile media platform 100. If a source of content includes content with the polled tags 108, then the content may be pulled down to the device or platform. The device may poll a mobile media facility and use tags 108 provided by the mobile media platform 100 to help select content for the device. The tags 108 provided by the mobile media platform 100 may include attributes associated with devices, users, and the like. Facilities of a mobile media platform 100 may tag content 108A based on consumption profiles 108E, user profiles 108G, device profiles 108F, and the like so that the content may be delivered through RSS to devices.

[0200] A function that may be associated with content ingestion may include tagging 108 content to establish a uniform basis for identification of content, describing content, and normalizing content with standard formats and descriptors.

[0201] Content tagging 108A may include multiple levels of tagging 108 which may include tags 108 in a physical file such as source content, encoded content, downloaded content, uploaded content, database content, content attached to an email, message, or other electronic communication, and the like. A tag 108 may be an explicit component of a file, such as metadata, a header, an inter-clip identifier, and the like. A tag 108 may be an implicit component of a file, such as an image tag 108 in a live linear feed. An image tag 108 may be a placeholder for content insertion, such as an advertisement.

[0202] Content tagging 108 may be automatic. The mobile media platform 100 may facilitate automated tagging 108, tag 108 recognition, decoding, interpretation, utilization, processing, creation, updating, and the like for content sourced by and/or distributed from the platform. All functions of the mobile media platform 100 associated with tagging 108 may be automated. Tags 108 and tagged content 108A may be automatically processed by ingestion 118, encoding 104, advanced transcoding 104, delivery 120, mediation, settlement, pause and resume, and other features, functions, and capabilities of the platform. In an example, content may be tagged 108 during ingestion 118 based on relevancy to one or more mobile user requests for content. Automated tagging 108 may be subject to and controlled by restrictions and/or rules associated with the tags 108, tagging 108 functions, tag 108 standards, and the like.

[0203] Tags 108 may include a name of a content clip, an artist, a genre, a content provider, a publication date, a file size, and the like. Tags 108 may be useful in allowing a content manager 902 to compile an album of content. In an example, digital music songs may be tagged with an album name and the mobile media platform 100 may organize the digital music songs so that songs with matching album name tags 108 may be combined. Alternatively, a user may request that the content manager 902 discover content with an album tag 108 and deliver the content to a user's device 802 as it is discovered. The tags 108 could then be used by the device 802, such as a digital music player (e.g. MP3 player) to organize a play list of the delivered, tagged content 108A based on the album name tag 108. Attributes associated with

tags **108** may be logical representations of content or information related to content as herein described.

[0204] Composite content may include one or more tags **108** that are associated with each type of content within the composite. Also composite content may not contain tags **108** that are related to content types that are not included in the composite. In an example, composite content that does not include audio type content may not include tags **108** that represent audio related attributes. In another example, when content includes composite content such as news content that includes audio, video, and text may include audio related tags **108** associated with the audio type content.

[0205] Tagging **108** may also help address content management **902** challenges associated with composite content, diverse content types, various encoding methods, device and delivery network differences, and the like. Tags **108** may facilitate a content management facility **902** in defining content in a way that relates to delivery to mobile devices **802** without enforcing strict content management **902** methods. Tagging **108** may allow a mobile media platform **100** to work with generic content such as media, documents, and the like. Tagging **108** may also allow for light content definitions while supporting a wide variety of content.

[0206] A mobile media platform **100** may facilitate an extensible model of tagging **108**, such as by offering flexibility and allowing continuous evolution of descriptors associated with tags **108**. Tag **108** model flexibility may be supported by tags **108** not being content, but rather tags **108** may characterize content in terms of aspects that are important to the platform or delivery. As an example, tagging **108** may describe image size, color depth, and the like within the image file itself. These tags **108** may include descriptors that may be embedded by a camera acquiring the image and delivering it over a network. Tagging **108** model flexibility may also support the addition of new tags **108**. Tags **108** may be newly defined as needed or desired to support content management **902** and delivery **120**. An example of a tag **108** that may be newly defined may be a camera model number tag **108** attached to image content. As content is moved from a source throughout a network, instances of the content may be tagged **108** to facilitate distributed sharing of content. In an example, a portable media player **802** may receive a local download from a user's personal computer of content that was delivered from the mobile media platform **100** to the personal computer. A content manager on the portable media player **802** may tag **108** the content based on associations of the content to other content already on the device so that when the newly tagged **108** content is uploaded to the user's personal computer, it may include the new tags **108**. If the newly tagged **108** content were ingested by a mobile media platform **100** content manager **902**, the new tags **108** may be detected, examined, and be included in a knowledge base of tags **108** associated with the media platform **100**.

[0207] The platform **100** may maintain tags **108** of significant and representative words in a media clip. These tags **108** could be used to locate time places and seek commands to return or search for timeline ranges to continue playback. Tagging **108** may be used to associate advertising targets and provide better relevance of association.

[0208] Enhanced encoding/transcoding **104** may support tags **108** provided within content, such as a camera model number within an image taken by the camera. A flexible tag **108** model associated with a mobile media platform **100** may allow for such use. A tag **108** may also include basic descrip-

tors related to content, such as is the image a photo, line art, rendering, cut from a video, and the like. In this way, tags **108** may define image content more precisely. A flexible mobile media platform **100** may support tags **108** that may add content to an item. Some examples may include a tag **108** holding text for a thumbnail image, a location of a full size image associated with a thumbnail image, the source of a thumbnail and the like. For content that may not be directly analyzed, such as binary content, tags **108** may be used to provide metadata. In this way tags **108** become vehicles for providing support and management of content that otherwise may be encrypted, or may include text in any language, and the like.

[0209] A content management facility **902** may utilize tagging **108** to represent portions of content in different modes. An audio track may be analyzed, the speech or lyrics may be extracted and converted to text, and the resulting text may be added to a tag **108** and attached to the audio content. Such an application may facilitate translating content, providing subtitles, supporting closed captioning, and the like. Also, text tags **108** may be analyzed similarly to text content. By building up tags **108** attached to content, the content becomes more readily analyzed and therefore may be more valuable. In an example, an advertiser may pay more to sponsor content that includes certain words such as a vendor name or sports team name. In this example, local news content that includes a story about a national sports team may be sponsored by advertisers who desire for their advertisements to be associated with the national sports team. The advertising may be automatically associated with the local content so that the local news provider may reduce costs associated with separately promoting their news broadcasts to acquire sponsors.

[0210] In addition to attaching tags **108** to content, tags **108** may be attached to content metadata **108B**, content wrappers **108C**, and the like. The mobile media platform **100** may support tags **108** associated with content **108A**, metadata **108B**, wrappers **108C**, enclosures **108C**, and any other aspect or element necessary or beneficial in content generation, distribution, delivery, management, use and the like. In an embodiment, a tag **108** may be geo-location data relating to the location at which the content was created or to which the content relates. For example, a tag **108** may include the longitude and latitude at which a photograph was taken.

[0211] When contrasted with composite type content, tagging **108** may provide more detailed and more extensive descriptions of content than what just a composite type indicator may provide. Tags **108** may further support a composite profiling process such as to enable transcoding based on information in the tag **108**, rather than just on the ingested content encoding format. Tagging **108** may provide descriptions of content in a way that is similar to how a news announcer provides descriptions for the images, video or other content provided to the user along with the news announcer audio. Tagging **108** may provide the rough equivalent of commentary in a sports broadcast. Tagging **108** may also including functional data such as URLs, addresses, contact information, actions, and the like. Tags **108** may include cumulative information such as access counts or download counts.

[0212] It is envisioned that new tags **108** may be created to facilitate using the mobile media platform **100**. Tags **108** that support the mobile media platform **100** may include front-end tags **108** (e.g. identify the content), middle-level tags **108** (e.g. functional tags that may direct actions within the platform), and back-end tags **108** that may facilitate customized user

experience. Tags **108** may also link up with other information such as information associated with a user including demographics, location, psychographics and the like.

[0213] Tagging **108** may provide benefits to content discovery by focusing on ways of discovering and acquiring the content. Seeking content based on a tag **108** or a tag value may allow better indexing of content and therefore may facilitate locating content. In an example, if a user is interested in receiving content that is certified by a regulatory agency, the regulatory agency may tag content that it has certified and the user may direct the mobile media platform to seek out content with a certification tag **108** from the regulatory agency. In this way the content may be handled by a secondary filter or targeting facility after it has been discovered through tag **108** searching. The agency may also use the mobile media platform **100** to seek out content that includes a tag **108** requesting certification. In this way content may be considered to be finding its own way from a content provider to a destination.

[0214] A content management facility **902** may use tags **108** to classify content into more descriptors. The descriptors may be tagged **108** with appropriate uses and actions to take with the content.

[0215] Tags **108** may themselves contain the purpose of the tag **108** so that tags **108** do not need to be predetermined into a limited set of tag types. A publishing engine may tag **108** content to determine the content destination and content routing or delivery systems may identify the destination tag **108** and thereby make appropriate routing decisions to move the content to its destination.

[0216] Tagging **108** may also facilitate building community through attaching community tags **108** to community designated content. In an example, a condominium association may publish various documents such as a master deed, master insurance plan, rules and regulations, meeting minutes, financial statements, association news, bylaws, and the like that may be available to the public but is most beneficial to members of the association. The content may be generated with an 'association' tag **108** attached that allows interested members of the public to receive the content published by the association.

[0217] Mobile media platforms **100** may beneficially utilize and support tags **108** to facilitate things like producing text from a soundtrack, accessing content descriptors without opening and analyzing the content, targeting network operators, determining aspects of a device on which a recorded content was recorded, and the like. By utilizing tags **108** for physically representing information relevant to the content, the tags **108** may provide descriptions about the content as well as about themselves. In an example, a tag that identifies content encoding format may allow an automatic encoding/transcoding **104** module to self-determine what is being encoded. Without tagging **108**, the encoding **104** may require the content to be opened to examine the content or a header of the content to determine the encoding format of the content.

[0218] Tagging **108** may be more broadly applied to facilitate use of user generated content and/or codec. Certain applications or tools are required to handle certain file types (e.g. Excel is required to handle files with a .xls extension in the file name). Without knowing the file type, it may be very difficult to determine which application or tool to use with a file. Tagging **108** the file or tagging **108** the content within the file may allow a content management system **902** to identify the correct application or tool for each file provided. In an example, a tagged **108** file that is tagged **108** with descriptors

of the file (e.g. file size, frames per second, bits per second, encoding rate, and the like) may be more easily handled in a mobile media delivery environment than an untagged file. The untagged file may need to be opened and analyzed to determine the relevant elements for appropriate enhanced encoding/transcoding **104**, delivery **120**, use and the like.

[0219] A mobile media platform **100** may manage content, including adjusting or changing content, to facilitate delivery of content and use of content by mobile devices **802**. When variables of the user, the device, and content related categorization are handled by the platform, tagging **108** becomes an attractive medium for robustly handling diverse and broad content related information. Operationally, tagging **108** also may facilitate matching content being requested to information about available content that is stored in tags **108** associated with the available content.

[0220] Referring to FIG. **14**, the mobile media platform **100** may include digital PVR type capability including pause and resume **114** of content **128** being ingested and/or delivered to a mobile user. Such capability may support resuming a content **128** stream at a point at which it was previously stopped. Pause and resume **114** capability may also facilitate error recovery **1404** that may interrupt playback of content **128** on a mobile handset. A pause and resume **114** functionality may be network based, thereby facilitating supporting any mobile device **802** without requiring changes to the hardware or software running on the mobile device **802**. Pause and resume **114** may be user initiated **1408**, system initiated **1410**, and the like. Certain types of content **128**, such as long form content **128**, may benefit from pause and resume **114** functionality in that users may be more likely to access long form content **128** knowing that they can pause and/or resume the content **128** so that the entire content **128** does not need to be viewed in one session. Pause and resume **114** may support various e-commerce methods **154** that associate content playback with an event such as payment or advertisement viewing, and the like.

[0221] Pause and resume **114** may be user configurable, such as with a user configuration facility **1440**, and user activated. A user may specify conditions associated with pause and resume **114** that may be associated with a user profile **204** and/or a consumption profile **102**. A user may access a pause functionality during content playback through features associated with a mobile device **802**. A user may access resume functionality when content **128** is accessed through a mobile device **802** or other compatible device. In an example, a user may signal that content **128** currently being presented on the user device is to be paused by pressing one or more function, data, or soft keys **1434** on a mobile handset. The keys **1434** may be fixed, programmable, or screen based. When a user accesses content **128**, the user may be presented with options associated with the playback of the content **128** including resuming playback of the content **128** based on a pause related action taken earlier by the user, the mobile device **802**, the network, a server, a carrier, and the like.

[0222] A device related action may cause a user initiated **1408** pause to require reestablishing a connection with the paused content **128** to resume playing. Device related actions may include battery power being low, a unit turning off due to battery power, a loss of signal, a pause timeout exceeding a device determined threshold, and the like. A network related action may cause content **128** being presented on a mobile device **802** to pause without the user taking any action. A

pause associated with a network may be based on network bandwidth limitations, duration of a session, signal quality, and the like.

[0223] Pause and resume 114 may be algorithm based 1412. Algorithm based 1412 pause and resume 114 may be associated with e-commerce 154, advertising, and the like. Content 128 may be provided to a user free of charge and may play free of charge for a trial duration, such as 30 seconds. At the end of the trial duration, the content 128 may be paused and the user may be presented with options for resuming the content 128. A user may be presented with an option of accepting responsibility for a charge that may be applied to a form of payment or may be automatically included in their mobile device 802 usage bill (for example). A user may be presented with other alternatives as well including, without limitation, submitting a form of payment such as through a payment facility 1442, agreeing to perform an action (e.g. viewing a commercial, taking a survey, and the like), providing demographic information, agreeing to receive additional content 128 (e.g. advertisements, promotions, and the like), and other alternatives as may be beneficial to the user, the content provider 1402, the network carrier, the mobile media platform 100, and the like. In an example, a user may have available a certain amount of credit in a prepaid credit account that may be used toward playback of content 128. Content 128 may be played back until the credit account has insufficient funds to continue playback at which point the playback is paused. The user may be presented with an option of topping off the credit account to resume playback. Because playback may not be dependent on the user device, the user may top off the credit account at a later time and resume playback any time after the credit account has sufficient playback funds. The user may use a payment facility 1442 associated with a user interface 140 to perform payment transactions.

[0224] Algorithm based 1412 pause and resume 114 may be used to pause creative content playback so that an advertisement or other sponsored content 128 may be presented. Because the algorithm may be based on aspects of the session, the user, the provider, the advertiser, the carrier, or the creative content 128, there may be no need to provide specific support for advertisements within the content 128 as is typically done. In an example, creative content 128 may be sourced and it may not include any special tags, markers, intersession breaks, and the like at which time an advertisement may be inserted. Instead, an algorithm, such as a duration of play time between advertisements, may be used to determine when to pause the content 128 and present an advertisement.

[0225] The mobile media platform 100 may include content 128 review or analysis functionality that may facilitate placement of advertisements in association with algorithm based 1412 pause and resume 114. In an example, an algorithm may identify a change of scene in the content 128 as an opportunity for pausing the creative content 128 to present an advertisement. Image analysis methods may be employed to determine change of scene. An algorithm may further include factors such as a user profile 204, carrier preferences, creative content provider 1402 preferences, advertisement placement demand associated with the creative content 128, and the like to determine pause and resume 114 of playback of creative content 128.

[0226] Pause and resume 114 functionality associated with a mobile media platform 100 may include location based factors 148. Pause of live content 128, such as performances or competitions, may occur based on a location of a mobile

device 802 displaying the live content 128. In an example, a blackout area around a live event, such as a sports competition, may be established to promote attendance at the event. A mobile device 802 that enters the blackout area during live playback of the event may be subjected to the blackout and the playback of the event may be paused automatically. Playback may remain paused, so that playback does not resume while the mobile device 802 remains within the blackout area. Upon exiting the blackout area, the playback may resume. Alternatively, playback within the blackout area may resume after a delay, such as after the completion of the competition. Other types of location based 148 pause may include a mobile device 802 moving outside a secure zone, such as the interior of a building or a secure property. Certain types of content 128 may be paused based on location of the mobile device 802. In an example, display of confidential information may be paused when a mobile device 802 is determined to be located in a public area such as an airport. Playback may be paused based on proximity of the playback device to other devices. Device proximity pause may be useful to limit unauthorized sharing of content 128, preventing unauthorized users from potentially viewing content 128, such as private content 128, and the like.

[0227] Pause and resume 114 may require no client side dependency 1414. The mobile media platform 100 may include one or more network components, such as a server, a streaming protocol server, and the like that may monitor content 128 delivery to a user so that resuming playback of content 128 may be requested by a user from another device. In an example, a user may be viewing playback when the battery of the mobile device 802 dies, the device disconnects from the network, and the playback stops. One or more of the network components may detect the mobile device 802 disconnection and may effect pausing the playback so that the user can resume the playback at a later time. The user may turn to a friend or co-worker and use their mobile device 802 to access the paused content 128. When the user accesses the content 128, the user may be able to select the paused content 128 for playback starting at the point when the user's mobile device 802 battery died. The paused content 128 may be made available to the user through a secure login, for example. For example, a user may pause playback of a video on his in-car device via WIMAX and resume viewing playback of the content on his PC or IPTV at home.

[0228] Pause and resume 114 may also be used to facilitate managing content sourcing 1418. Streaming content 128 that is being sourced from a first content source may be paused and upon playback resumption, the content 128 may be sourced from an alternate source, such as a preferred source. In this way, a user may select content 128 for playback and the platform may adjust content sourcing to manage bandwidth, costs, and the like. In an example, a user may request content 128 and to ensure delivery of the content 128 to the user is not delayed, the mobile media platform 100 may begin streaming content 128 from the first source detected containing the content 128. However, the platform may determine that another source, such as a file repository of the mobile device 802 carrier, contains the content 128 and that using the carrier provided content 128 would benefit one or more of the user, the carrier, the content provider 1402, the platform, a sponsor, and the like. Pause and resume 114 functionality associated with the platform may briefly pause the playback and switch to the preferred source to resume playback. Alternatively, the platform may not pause playback but instead pause ingestion

and seamlessly switch delivery from the first identified source to the preferred source using the methods of resuming playback as herein described. This may be accomplished by the platform identifying a point in the content **128** at which the ingestion is paused and requesting streaming of the content **128** from the preferred source at the pause point and then seamlessly delivering the content **128** from the preferred source in sequence with the pause point of the first source. Seamless transition from the first to the preferred source may be facilitated by pipelining content **128** from the first source to establish a buffer of content **128** that is accessed until the preferred source playback is available.

[0229] Pausing and resuming playback may be beneficially applied to short form content **128**, long form content **128**, live content **128**, on-line games, video, audio, e-books, multimedia content **128**, and any other type and composition of content **128** as here in or otherwise disclosed. Live content **128** may be buffered, such as in temporary storage, during a pause so that playback can be resumed immediately by the user. If the content **128** is paused for an extended time, the content **128** may be transferred to more permanent storage to allow playback at a later time while reducing platform resources that otherwise may be used for delivering unpaused content **128**.

[0230] Referring now additionally to FIG. 15, pause and resume **114** functionality may be supported by aspects of the mobile media platform **100**, such as a Real Time Streaming Protocol (RTSP) handler facility **1424**. A RTSP handler facility **1424** may include a client RTSP request handler **1502** that accepts RTSP requests from a client. The client RTSP request handler **1502** may decode the RTSP into a request that a streaming server will understand. The client RTSP request handler **1502** component may also keep track of intended start time per request as well as information about the user. It may also translate the response from the streaming server. A server side RTSP IO handler **1504** may handle basic input/output operations related to the streaming server. A session tracker/monitor **1508** may maintain an in-memory map of the active client connections the RTSP handler **1502** is handling. An RTP packet monitor **1510** logs the number of bytes transferred per stream per session. An embedded Derby **1512** is the repository where the RTP packet monitor **1510** logs and persists information. In an example, when RTP data packets are transmitted to a destination (e.g. a mobile device **802**), the RTSP handler **1502** may record the number of bytes transferred per track. On termination of a session the RTSP handler **1502** can transmit the total number of bytes transferred. A message-driven bean (MDB) **1422** associated with the mobile media platform **100** may receive this byte count and may calculate the position at which the client stopped viewing the clip. Alternatively, the functionality of calculating stop and resume position may be performed by other aspects of the platform including the RTSP handler **1502**, an RTSP proxy **1514**, and the like. An RTSP proxy **1514** may be an open source proxy server that works with the RTSP in multimedia streaming reproduction. Its purpose may be to establish the conditions of an audio-video streaming session. This protocol may allow a client to remotely control a streaming media server, issuing VCR-like commands such as “play” and “pause”, and allowing time-based access to files/live broadcasts on a server. The streaming data may then be sent over other channels using other protocol such as RTP (Real Time Protocol), and the like.

[0231] Pause resume functionality may use a Multipurpose Infrastructure for Network Applications (MINA) framework **1420** to help users develop high performance and high scalability network applications easily. MINA **1420** provides various event driven and asynchronous APIs. MINA **1420** may support various transports such as TCP/IP, UDP/IP via Java NIO, and the like. MINA **1420** presents advantages over raw NIO protocol by separating “Networking Code”, “Protocol Codec” and “Business Logic”. MINA **1420** may be used to form an API over which an RTSP proxy **1514** may be written. The RTSP proxy **1514** may be capable of accepting requests from RTSP clients, translating, forwarding them to a streaming server, keep track of bytes transferred per session, and the like.

[0232] The RTSP facility **1424** may be associated with a consumption profile **102**, a user profile **204**, a device profile **202** and the like to enhance pause and resume **114** functionality associated with the mobile media platform **100**.

[0233] Referring to FIG. 16, methods and systems of mediation and settlement **112** are herein described. A mobile media platform **100** may be associated with mediation and settlement **112**.

[0234] Content providers **1624**, such as creative content **128** owners, are continuing to look for new and broader methods of distributing their content **128** and for opportunities to further monetize content **128**. In addition, the number of content providers **1624**, dealers, affiliates, and the like are continually increasing. To facilitate distribution of content **128**, such as creative content **128**, sponsored content **128**, promotional content **128**, and the like an increasing number of content **128** distributors are offering opportunities for marketing content **128** to end users. Likewise mobile device **1614** service carrier **1682** continue to offer expanded networks, capabilities, services, and support a widening array of device types and features. Content **128** types continue to diversify, essentially increasing the number of different types of content **128** that must be handled by the distributors, the carriers **1682**, the devices, and the users.

[0235] Within this expanding mobile content **128** service environment, a mobile media platform **100** may facilitate a radical change in how content **128** is sourced, encoded, combined, distributed, tracked, mediated, financially settled, reported, and the like. The user may benefit from the mobile media platform **100** in that the user may receive more satisfying content **128** at ever lowering costs. Carrier **1682** may benefit from the mobile media platform **100** by gaining financial control over the extraordinary reach of their networks while facilitating a more open mobile content **128** distribution and access environment. Creative content **128** owners may benefit from a mobile media platform **100** by better accounting of the uses of their content **128** and near universal access by all mobile users to their content **128**. Content **128** sponsors, such as advertisers **1684** may benefit from a mobile media platform **100** by increased flexibility in ad serving without compromising ad reach or increasing expense for distributed but unviewed ads. The methods and systems of mediation and settlement **112** describe herein may provide these and other benefits.

[0236] A mobile media platform **100** may support a very large quantity of an increasing array of content **128** types that are provided by an increasing number of creative and sponsored content **128** owners to carriers **1682** that continue to diversify their offerings to end users. Mediation and settlement **112** may facilitate normalizing the diversities created by

the content **128** owners, content **128** types, carrier **1682** requirements, and device functionality so that content **128** view accounting, tracking, and therefore business methods associated therewith may be substantially improved. Normalization associated with mediation and settlement **112** may include establishing and maintaining a media data record **1692** that may be associated with one or more media data events, transactions, interactions, user activity, automated content **128** selection and serving, and the like. Through the use of a media data record **1692**, mediation and settlement **112** may allow the business methods to accurately indicate content **128** distribution related revenue that is shared by each partner, for any transaction (event), for any application (service), at any given time, and based at least in part on an understanding of the revenue sharing partners at the time of the event and each partner's quota in revenue sharing at the time of an event represented by the media data record.

[0237] A media data record **1692** may include information associated with a mobile content **128** event or events wherein the information may be sourced from a wide array of record keeping and accounting systems. The media data record **1692** may be a normalization of the various data sources. Media data record sources may include different streaming servers, such as different streaming logs that have varying formats, content **128** order, recording methods, and the like. In an example, a media data record **1692** may content **128** streaming data that is normalized from data from one streaming server that records a count of packets streamed and average time duration of each packet and from data from another streaming server that records a start time, an end time, and a count of packets. Both streaming server data records can be normalized in a media data record **1692** to allow mediation and settlement **112** using the one and the other streaming server data. A media data record **1692** may include a wide variety of information associated with distributing and playback of content **128**, such as mobile content **128**. A media data record **1692** may include content **128**-based information (e.g. owner, sourcing server, sponsor, length, genre, type, encoding, origination date, modification date, and the like), carrier **1682**-based information (e.g. carrier **1682** name, geographic region served, network features used, service plan, and the like), user-based information (e.g. demographics, user ID, preferences, and the like), device-based information (e.g. device type, device capabilities and features, status of battery power, and the like), ad-based information (e.g. ad server URL, ad cost, ad payment options, genre, target user, ad type, and the like), and other information as may benefit mediation and settlement **112** of mobile content **128** distribution.

[0238] A media data record **1692** may include, or may be used to determine viewing of portions of content **128** associated with the media data record **1692**. Streaming content **128** delivers content **128** to a user device desktop or interface so that the user is presented the content **128** as it is streamed to the device. A media data record **1692** may facilitate determining, on a packet by packet basis, which portion of the content **128** was streamed to the user device and therefore presented to (or viewed by) the user. Therefore even if a user terminates a request for streaming content **128** after only a portion of the content **128** is streamed, the mediation and settlement **112** functionality of the mobile media platform **100** may determine what portion of the content **128** was viewed and associate the viewed portion with participants (e.g. content **128** owners, advertisers **1684**, and the like) represented in the viewed portion to ensure accurate accounting for payment

and/or invoicing the participants. Referring to FIG. **17**, in an example, a user may request to view content **128** that is thirty minutes long, such as in the logical step **1702**. However, the user stops viewing after only ten minutes, such as in logical step **1704**, by canceling the stream, such as by pressing 'stop', selecting another function, turning off the mobile device **1614**, or closing the top of a two-piece mobile device **1614**. The mediation and settlement **112** functionality may access the mobile media data record **1692** and determine the owner or owners of the content **128** streamed in the first ten minutes, such as in logical step **1710**, and take an appropriate action, such as determine a share of revenue from the viewed segment, such as in logical step **1714**, determine payment for viewing of an advertisement in the viewed segment, such as in logical step **1712**, and the like. Mediation and settlement **112** may also make note of content **128**, advertisements, and the like associated with the unviewed portion of the content **128**, such as in logical step **1718**, and make this information available to participants for purposes such as marketing research, accounting reconciliation, and the like. Revenue share may be allocated across many different participants and may be based on each participant's complex share agreement. In an example, revenue share settled through mediation and settlement **112** may result in 10% for each ad that is stitched with streamed content **128**, 30% for the carrier **1682**, 30% for the creative content provider, 10% for an external reference (search, affiliate, and the like), and 20% for an operator or owner of the mobile media platform **100**.

[0239] Advertisements may be streamed to a user device **1614** in coordination with creative content **128**. Advertisements may be served from a third party ad server **1694** and may be served directly to the user device **1614** without being distributed by the mobile media platform **100**. In this situation, the mobile media platform **100** may have determined, based on examining the content **128** packets being streamed to the user device **1614**, that an advertisement was served, yet the source of the ad and the owner of the ad may not be directly known by the platform. To facilitate completion of the media data record **1692**, either the ad server **1694** may notify the mobile media platform **100** of the request/service of the advertisement or the mobile device **1614** may report back to the platform **100** which ad was served. Alternatively, the information associated with the ad request and serving may be logged by the ad server **1694** so that the log is available to the mobile media platform **100**. The information from either the ad server **1694** or the device **1614** may be near real-time, may be posted at a scheduled time, or may be aggregated and made available to the platform **100** based on an aggregation threshold being reached (e.g. a number of ads served, a cost of ads served, and the like). Ad serving may be facilitated by using content **128** that includes metadata as defined by the SMIL standard. SMIL is an example of ad aware playlisting technology that may allow the mobile media server **1698** or the user device **1614** player to reach out to an advertisement server **1694** to pull an advertisement to be presented to the user. A data collection agent may be associated with or operated in association with the media server **1698**.

[0240] The mobile media platform **100** may include a Real Time Streaming Protocol (RTSP) handler **1658**, such as an RTSP proxy **1662**, that may analyze each packet sent to the user device so that an accurate determination of what content **128** was delivered to the user. The RTSP proxy **1662** may also analyze the content **128** to determine if the content **128** is

creative content 128, advertising, public domain, privately owned, licensed, and the like to further facilitate generating an accurate media data record 1692.

[0241] Mediation and settlement 112 may be beneficial to carriers' 1682 efforts to monetize their networks while opening them to additional sources of content 128. Mobile network carrier 1682 typically maintain content 128 traffic tracking systems for network management (to manage spikes, and the like). Mobile network carriers' 1682 tracking systems may not include application logic or content 128 analysis capabilities that facilitate mediation and settlement of content 128 value and network feature utilization with content providers. As carriers 1682 move from substantially closed networks in which they control all of the content 128 provided on their networks to open access networks, the mobile media platform 100 may allow the carrier 1682 to measure network utilization and allocate costs to content providers 1624 as well as sharing in revenue associated with sponsoring (advertisements) of the content 128. Carrier 1682 may create new business models, new billing plans, and the like that may be based around accurate measurement of content 128 value, advertisement value, and the like based on viewership of the content 128. In an example, a carrier 1682 may sanction MTV to openly deliver videos over the carrier 1682 network. Although the carrier 1682 may not control the content 128 being provided (presumably MTV controls the content 128), the carrier 1682 can receive compensation for the use of their network based on data in a media data record 1692. In an example, MTV streams a trailer of a new movie to users on a mobile carrier 1682 network. The mobile media platform 100 may determine, through mediation and settlement 112, that the trailer is viewed by a minimum number of users and the carrier 1682 is notified by the platform 100 so that the carrier 1682 may debit a planned amount from the promoter of the trailer. Content 128 that utilizes a network carrier 1682 high bandwidth capability may be charged differently by the carrier 1682 than content 128 that is served using a low bandwidth network. The media data record 1692, and therefore mediation and settlement 112 may take factors such as bandwidth utilization into account when determining an allocation of revenues or charges associated with content 128 distribution. Similarly, mediation and settlement 112 may be beneficial to a third party participant of the platform 100 in facilitating settling their portion of the revenue share or costs associated with content 128 distribution. Mediation and settlement 112 may also enable third parties to make adjustments in their business, such as if they were paying too much, not paying enough, and the like.

[0242] A media data record 1692 may be associated with a mobile content 128 transaction such as a usage event, an ad pull, streaming of creative content 128, requests for content 128, and the like. A mobile media event may occur substantially within a media player. To facilitate capturing mobile device 1614 based media events, media players may be directed to provide input to the mobile media platform 100 based on the content 128 provided and the media event. By accepting a stream of privately owned content 128, a user may also agree to allow the media player to report mobile media events such as replay, fast forward, and other events associated with the stream.

[0243] Participants may access information associated with mediation and settlement 112 through a self-care interface 1696, such as a graphical user interface, a program interface (e.g. an API), and the like. A self-care interface 1696

may make information available so that participants may react to information as it is gathered and normalized in one or more of real-time, daily, weekly, based on a threshold associated with mediation and settlement, and the like.

[0244] A mobile media platform may be associated with various types of content that may be sourced from a variety of sources. Types of content may include audio, video, text, images, photos, applications, games, data, ring tones, wall paper, fonts, hyperlinks, tables, tabular formatted text, user generated content, media, radio, content primitives, composite content, marketing type content, and the like, and new content types that may continue to be invented and adapted over time that the mobile media platform may extend to cover.

[0245] Primitive content types may include basic types such as text, images, and the like. Composite content may include a plurality of primitives such as an image with overlay text or a video with a soundtrack. The mobile media platform may manage an assembly of primitives as composite type content. Marketing type content may be various composite configurations that may be associated with market media such as a music video, a news broadcast, and the like. The mobile media platform may manage an assembly of composite and/or primitives as marketing type content. The content may be short form content. Short form content may be content a user consumes in a single content consumption episode. Short form content may be content consumed during content snacking behavior. Short form content may be content less than approximately five minutes in length. Short form content may include short clips of news, weather, sports, comedy music videos, movie trailers, user generated content, adult content and the like. The content may be long form content. Long form content may be content a user consumes over multiple content consumption episodes. Long form content may be an approximately 20 or 45 minute episode. Long form content may be longer than 5 minutes. Long form content may be comprised of a series of short form content. Long form content may be a movie having a duration of over an hour. Longer format content may include TV shows, movies, live events, such as sports, music, and news, and the like.

[0246] Content may be short head content which may be very popular content. There is typically a small number of very popular content titles comprising the short head. After the short head there is typically a rapid decline in title popularity, followed by a populous but relatively unpopular set of titles which have appeal to a relatively smaller audience, comprising the long tail. In embodiments, catering to the audience of long-tail content can be as lucrative as catering to short head audiences. Content includes all new types of content invented over time.

[0247] Content, such as content associated with the mobile media platform, may be sourced from a variety of sources. The sources may be associated with a content type, such as a primitive, composite, or marketing content type. The mobile media platform may support content sourced from content owners, content creators, movie studios, television networks, broadcasters, individual content creators, radio broadcasts, pod casts, digital sources, audio sources, mobile carriers, satellite broadcasts, cable, media companies, databases, archives, content programming, content aggregators, files, streaming sources, and the like. A file source may be static and represent a discrete instance of content. Streaming content sources may generate dynamic real-time content that may not be associated with static or discrete instances of content.

[0248] Content that may be associated with the mobile media platform may include a wide variety of content and may represent a wide variety of material including, without limitation, television shows, movies, movie trailers, sporting events, music videos, instrumental videos, news, music, lectures, talk shows, commercials, classic television shows, classic commercials, play lists, electronic programming guides, games, programming languages, markup languages, home movies, documents, transactions, records, and the like.

[0249] Referring to FIG. 18, live content sources may be include analogue cable **1802**, descrambled digital cable **1804**, satellite feed **1808**, Video over IP **1810** such as RTSP, MMS, UDP live stream, and video over IP SDP live 3GPP feed **1812**. Each live unencoded source may be fed into a live raw encoder **1814** configured for the incoming live source. The encoded sources, such as a SDP live 3GPP feed **1818** may be presented to the mobile media platform **1820** for distribution to mobile devices **1822**.

[0250] Web content may be content originating on the World Wide Web or the Internet. Web content may have originated from a different source directly or indirectly before being placed on the World Wide Web or Internet. Any of the types, sources and examples of content discussed herein may be web content. With the mobile media platform web content may be delivered to a mobile device. Web content may require user interface enhancements and/or high capacity transcoding, such as on a server or on a client to deliver web content to wireless devices that provide high degrees of customer satisfaction.

[0251] A mobile media platform may include content ingestion functionality and capability that may be associated with a consumption profile, content management, and the like. Content ingestion may include activities associated with sourcing, acquiring, packaging, and adapting content for distribution to any mobile device. In addition to the content types and sources, content to be ingested may be acquired from sources of various or unknown quality. Not only may the integrity of the content (for purposes of safely ingesting the content) be in question, but the content may not fairly match information that may describe the content such as metadata or keywords. The mobile media platform may support various techniques to acquire, tag, encode and/or package any digital format of content for distribution to mobile devices over a mobile service network.

[0252] A mobile media platform's content ingestion may acquire content by polling third party sites for content, may use content source methods, such as RSS, spiders, direct user download, automatic update and the like. In an example, content may be submitted or obtained via an interactive web ports, FTP upload (push or pull), or a Web Service API.

[0253] The mobile media platform capabilities and features may include hosting; which may be configured as a secure site and may include redundancy to ensure ingestion and delivery of content to mobile users. Hosting may involve making content available or receiving content over a network. In an embodiment, hosting may involve making content available to or receiving content from a mobile device. Hosting may involve at least one server and at least one client.

[0254] The mobile media platform may be associated with and may facilitate delivery to mobile devices. Content that is delivered may be personalized using similar genres, teams, communities of interest, and other content based mechanisms. Delivery may include downloading such as delivering content via HTTP, RTSP download with additional wrappers

for DRM, and the like. Delivery may be performed with streams, such as to delivery audio and video content via 3GPP, Real Media streaming, and the like. Delivery may include other types of download, including progressive download.

[0255] Delivery services associated with the mobile media platform may determine an appropriate mechanism to deliver a specific element of content based on the element's type, the application to which it will be delivered, a user's preferences, device and network capabilities as describe herein below. Delivery may include delivery of messages to an end user.

[0256] Delivery may include combining delivery of content from different sources or via different means. The mobile media platform may contain an application that combines the on-demand delivery of video over a cellular network with live television broadcast content that is delivered over a mobile broadcast technology, such as DVB-H, DMB, MEDIAFLO or the like, together into a single user experience.

[0257] In an example, a user watching a mobile broadcast of a sporting event may be provided a link to view a pre-recorded video clip that covers the highlights of the game to that point. Clicking the link may result in the application switching video delivery sources from the mobile broadcast network to the cellular network and causing the highlighted video clip to be streamed on-demand to the user via the cellular network. After viewing the clip, the users could be provided other links to allow them to choose from a list of other content that is available on either the broadcast or cellular networks.

[0258] In another example, the application may simultaneously source content from various networks and/or external repositories and integrate the data from these various sources in order to provide the user with a high quality experience. Additionally, the content sourced from various networks and/or integrated repositories may be related to the interests, whether accumulated or point in time, of the user. This may reduce or remove a need to search on the mobile handset. This process may result in effectively increased bandwidth.

[0259] The mobile media platform may facilitate visibility of available content. The mobile media platform may facilitate periodic dynamic generation of a content catalogue feed (such as in XML, RSS and the like) with special listings of content to enable content items to be indexed by external systems, such as search engines, web crawlers, spiders, and the like. The catalogue feed may be posted and retrieved by an external system. Alternatively the catalogue may be pushed, such as through RSS, email, WAP push, and other delivery mechanisms. In addition, these special listings of content could include featured, recommended, or popular listings of content that are editorially based or algorithmically generated.

[0260] Platform content visibility may include visibility into consumption profiles, device profiles, ingestion profiles, and any other type of content, data, or information associated with the platform. In an example, the content catalogue feed could include user information such as aspects of a user's consumption profile in order to facilitate an improved user experience through targeted presentation of services to the user or to support user loyalty based services.

[0261] Content, including web content, may be delivered to or received from a mobile device. In embodiments, delivery of web content to a mobile device may require high bandwidth and/or on-demand transcoding. In embodiments, delivery may be in the form of a notification, such as an email, text

message or instant message, including a link or reference to the content or with the content embedded in the notification itself.

[0262] The mobile media platform may support optimization associated with various processes, capabilities, and features of the mobile media platform. Optimization may be enacted for ingestion, encoding, transcoding, hosting, delivery, and the like. Optimization may be used to create device profiles. Optimization may support adjusting to available bandwidth that is available for content delivery. Bandwidth adjustment optimization may be a function of the mobile network technology (e.g. cellular (GSM, GPRS, EDGE, HSDPA, UMTS, CDMA, CDMA 1x, EV-DO, etc.), Wi-Fi, WIMAX, UWB, BLUETOOTH, MEDIAFLO, DVB-H, DMB, and the like). Bandwidth adjustment optimization may also be a function of the mobile device's network capabilities. In an example, although an operator network provides GPRS, EDGE and HSDPA network connectivity, a mobile device attempting to access our content may only be capable of connecting to GPRS networks. Bandwidth related optimization may also be a function of the effective bandwidth of the network as a function of the mobile operator's specific network configuration. Optimization may also be based on variations in the bandwidth as a result of the mobile device moving from one network technology to another during a content consumption session. Optimization may be implemented by adjusting encoding parameters (e.g. frames per second, bandwidth allocations, codec and the like) to suit current network capabilities.

[0263] Optimization may be associated with device playback capabilities so that a device with different audio and video capabilities may be delivered composite content that meets the device capabilities for presenting each. Differences may include different video and/or audio CODECs, capabilities of onboard players and/or CODECs. In an example, for different CODECs, each CODEC may require different encoding settings based on variations in screen size, variations in color depth, resolution, device memory, device CPU power, and the like. Optimization may also be based on device content delivery mechanisms, such as streaming, downloading, progressive download, MMS, WAP push, and the like.

[0264] Optimization may also be associated with digital rights management (DRM) and may be a function of the mobile device's DRM technology, or may be a function of the mobile operator's choice of DRM.

[0265] Content characteristics related to optimization may include automatically determining characteristics of the content itself (e.g. talking head .vs. sporting event in which the picture changes rapidly and significantly), human or algorithmic determination.

[0266] The mobile media platform may facilitate packaging content including repackaging ingested content. Packaged content may be provided in archive files, such as Quick-Play archive files, in a proprietary file structure, may combine metadata and multiple versions of the media itself. Packaged content may be delivered through a batch encoding, a single encoding, and real-time encoding. Packaging content may include wrapping content in descriptors defined in XML.

[0267] A mobile media platform may also include storage and at least one storage facility. Storage may be for the storage of content, data, metadata, attributes, parameters and the like. Storage may be online or offline, provided through the platform, provided on a mobile device and/or provided through a

network. Storage may be provided using various methods, including, without limitation, magnetic storage, optical storage, semiconductor storage and the like. Storage may be provided using various devices, including, without limitation, a hard drive, flash memory, tape drive, magnetic disks, optical discs, minidisc, semiconductor memory, USD flash drive, xD card, SD card, compact flash card and the like.

[0268] A mobile media platform may include a user interface for enabling interactivity, viewing thumbnails, facilitating game day tracking, enabling rich new reader features, managing end user presentation, and the like. The user interface may also include dynamic rendering of text and images to optimize the user's experience based on the user's device capabilities. The user interface may include skinning, multi-tabbing, content schedules, daily features, flipbooks, sliders, displaying multiple items at once, split screen applications, and the like.

[0269] Enabling interactivity may include framing content with links, such as presenting information about content in a frame around the content. In an example, framed content may be created from a baseball game broadcast. The frame of the broadcast content may include links to websites of the sports teams involved in the broadcast, statistics such as team standings, information about the contest (e.g. date, time, starting pitcher, current balls & strikes, links to advertisers or information about products included in the broadcast, and the like.

[0270] A user interface associated with the mobile media platform may, for example enable displaying thumbnail images that can be integrated into textual displays. In an example, a device may have limited screen size that is known to the mobile media platform through a device or consumption profile. A document with integrated text and graphics may be transcoded and/or reformatted based on the device profile prior to delivery so that the graphics may be adapted to be replaced with thumbnail images. The thumbnail images may be identified and tagged during an ingestion process of, for example, the document, the images in the document, content from a thumbnail generation or lookup web service, and the like. Alternatively the mobile media platform may reformat an image during ingestion to generate and store a variety of thumbnail images based on a variety of profiles (e.g. consumption, user, device, network) associated with the mobile media platform. The generated thumbnail images may be tagged so that when content referencing or including the source image is requested by a mobile device, the appropriate thumbnail image may be selected and delivered to the requesting mobile device. Thumbnails may also be interactive in that they can include active elements so that when a thumbnail that is displayed on a mobile device is selected, an expanded image, a video, or an audio stream may be delivered and presented. Thumbnails need not be small enough to fit on the mobile device screen. A thumbnail may be scrollable, such as through a built in user interface of the mobile device or through an interactive framing of the thumbnail.

[0271] Applications of a user interface associated with the mobile media platform that may be presented to a user of a mobile device may include game day tracker or a rich news reader. A game day tracker may include a multi tabbed view of the latest news with images, text, audio and video, and the like. Real-time updates of in-game scores, final results, standings, rankings, fantasy football results, and the like are some examples of game day tracker information that may be made available to a mobile user. A rich news reader may push information tickers, news stories with images, audio, video

and text integrated into a single view. One approach to facilitate a rich news reader is to tag news stories with metadata so that multiple media types associated with the same story can be displayed together in an integrated fashion.

[0272] A mobile media platform user interface may facilitate managing end-user presentation of content and the like by supporting UI widgets (e.g. user interface related software that generate interactive content), a light client approach, an upgrade process, presentation of interactive elements (e.g. widgets), presentation of a discovery interface, presentation of recommendation interface, personalization of the user interface, and the like.

[0273] A mobile media platform may include an administrative user interface allowing mobile users, administrators and other users of the platform to configure and manage all or certain aspects of the mobile media platform. In embodiment, the aspects being managed using the administrative user interface may include ingestion, content management, content delivery preferences, reporting, analytics and the like.

[0274] A user interface may support or include other features that may optimize a user's experience. These features may include dynamic rendering based on a device profile, presentation of multimedia elements simultaneously within a unified environment, skinning (e.g. user determined, content determined or branded), multi-tabbing, content schedules, daily features, flipbook of images for browsing, a pop-up or fly-in menu (e.g. a scroll wheel type dial), sliders that may add fluidity to menus, displaying useful related content simultaneously (e.g. music download selectable icon while a music video is playing), split screen (e.g. watch a sports broadcast and type a text message).

[0275] A mobile media platform may facilitate notification and delivery of messages to mobile device users. The mobile media platform may support user directed management of notifications so that the user may determine how and when notifications, alerts, and messages are delivered. A notification may be related to content. In an embodiment, a notification may be an email, text message, instant message or the like, which may include a link or reference to the content or with the content embedded in the notification itself. Notifications may be related to availability of new content, reminders of broadcast content schedules, delivery of email, billing notices, advertisements, and the like. In an example of notification and message facilitation, the mobile media platform may track user notification preferences and generate a message when an event occurs that matches user preferences. In another example, the mobile media platform may construct messages and use a message management module to deliver the constructed messages to a network operator messaging system.

[0276] Referring to FIG. 19, a mobile device desktop **1902** may include a notification **1904** of an email notification. Upon selection of the desktop notification **1904**, an email notification icon **1908** may indicate mobile content being associated with an email. Selecting the email notification icon **1908** may result in content being delivered to and presented on the mobile device.

[0277] The mobile media platform may facilitate content discovery. Content discovery may include search, recommendations, content catalog feeds, management, filtering, rating, community polling, personalization, tagging, processing, hierarchical organization, and the like. Search may include searching content, metadata, tags, categories of content, third party search integration, crawling multiple content stores

(and presenting in one unified search result), and the like. Examples of recommendation capability associated with the mobile media platform may include a recommendation engine for generating recommendations that may include popular clip algorithms, such as most consumed content, popularity based on a community, popularity based on all users (mobile and non-mobile), popularity based on a subset of users related to the current user (e.g. similar interests, preferences, purchase history, etc). A recommendation engine may generate recommendations based on inferred preferences via algorithmic analysis of historical usage behavior, based on direct user preference input, based on mobile activity context, such as the sensed context of the user, (e.g. location, time of day, type of handset, network operator, time of year, and the like).

[0278] In a certain embodiment, the mobile media platform may provide a user with accurate suggestions of relevant content before, during and after a user starts their viewing session to allow the user to quickly engage. Notifications, for example, of upcoming preferred live programming or the availability of new pre-recorded content the user will enjoy, will allow the user to decide what content to watch, and when. The mobile media platform may provide cross-referral suggestions of content while the user is viewing other content, allowing the user to discover more widely varied content. The mobile media platform may understand the user's viewing habits. For example, the platform knows a particular user watches sports highlights and weather in the morning and their favorite sports team and which weather coverage areas they are concerned with and may use this information to deliver appropriate content. In another example, the platform may know that a user typically watches the market recap on their commute home, and is able to adjust the user's experience appropriately by automatically providing the market recap content and related content.

[0279] Content may be discovered using keyword searching, metadata sources, recommendation engine, deep linking, MyPlays, popular plays, and the like. Metadata sources that may enable content discovery may include keyword tagging during an ingestion process, voice to text recognition, third party public databases (e.g. IMDB, GRACENOTE), third party private databases (e.g. subscription, membership based) in-house databases (e.g. via integration with content provider and/or operator managed databases).

[0280] Content discovery may be associated with a recommendation engine. Newly discovered content may be dynamically recommended to a user based on the user's historic content behaviors. Content management facilities may be directed to discover content to fulfill a recommendation requirement of genre, topic, or other categorization that a user has directly or indirectly demonstrated an affinity for. In an example, new content may be separated from previously discovered content to so that only new content is presented to the user as recommended content.

[0281] A content catalog feed may enable content discovery, such as in connection with search and recommendations. In an embodiment, a content catalog feed may be provided to search engines, including mobile search engines. In this manner, content on the mobile media platform may be included in search results, including mobile search results. In an embodiment, a content catalog feed may be able to enable recommendations. In an embodiment, a content catalog feed may be associated with an active push or feed of content. In an embodiment, a content catalog feed may be associated with a

passive pull or post of content, such as through the use of a search engine, web crawler and the like. Content discovery may be enabled through content management. A generalized content management data model may allow the mobile media platform to provide the ability to manage any type of digital data.

[0282] Content discovery may be facilitated by deep linking. In embodiments, there may be a defined URL for an item of content, which may allow for the promotion of content and viral distribution. In embodiments, WAP push may be used to access the link. Content discovery may be associated with MyPlays in that new content that is related to criteria for MyPlays may be presented as a shortcut (e.g. at or near a top level of navigation) to facilitate a user immediately accessing favorite areas of content. Content discovery may also provide input to MyPlays capability of the mobile media platform so that new content that may have a high relevance to a user's MyPlays content description may be available through a MyPlays short cut. Similarly, content discovery and a popular plays facility may allow a user to immediately access the most popular content directly from the top-level menu of a personal portal page. To facilitate an association of content discovery and popular plays, a popular play facility may combine the number and/or frequency of downloads with various sources of user ratings of a content to determine popularity.

[0283] In addition to the content management features associated with content discovery, content recommendations, and content search, content management may also include content filtering that may allow a user to setup various content based filters, content rating that may enable a user to view content rating and generate content ratings (e.g. using a star system, averaging ratings, through feedback), community polling through flexible format multiple choice questioning, personalization of content delivery (e.g. based on a user profile, a consumption profile, operator or wireless carrier input (based on data about the user that comes from the carrier), various personalization algorithms, recommendations, ratings, and the like), tagging of content, font processing, hierarchical category organization, clip-based retrieval, and the like. A generalized data model may provide the ability to manage any type of digital data.

[0284] A consumption profile may include history of content consumed over a period that may facilitate personalized content discovery features for end users. One such feature may include popular plays—a popular content listing may be generated based on aspects of content consumption history, average user ratings of content, and the like to create a ranked list of content. Another such feature may include personalized recommendations that may be based on a consumption profile (e.g. consumption history, user preferences, and the like) by associating keywords and category names of content with the consumption profile.

[0285] A mobile media platform may provide and/or utilize information relating to the location of a mobile device or user and/or intelligence derived in whole or in part from such location information. Location information may be determined or provided by the mobile device, using a global positioning system or a similar technology, by the mobile media platform, by locating a device on a network, such as a cellular network or WiFi network, by user input, by examining transactions and selections made using the device and the like. Location information may be updated in real time, at set intervals, periodically, on-demand and the like. In an embodiment, location information may be used to identify businesses

located near to the user. In an embodiment, location intelligence may be used in conjunction with other information to present content to a user. In an example, the location of a user combined with data regarding the time of day may be used to present the user with advertisements, menus and coupons for restaurants located in the vicinity of the user. In an embodiment, location intelligence may include determining if a user is in a car, train or plane based on the location of the user and the velocity of the user. In an embodiment, location intelligence may be used to determine that a user is approaching a traffic jam and local traffic video content may be presented on the mobile device.

[0286] A mobile media platform may be characterized by a personalized user experience. The platform may leverage information about users and user preferences to personalize the user experience. In embodiments the platform may leverage recommendations from the communities to which the user belongs and use the information to present relevant content. In an example, for a sports fan the platform may include the user's favorite teams at the top of menus and search results to make it easier for the user to locate relevant content. This is especially helpful since on a mobile device it is difficult to present more than 2 or 3 links, not 20 or 30 as on a computer. In another example, a user may routinely watch the news, weather and horoscopes every morning. As a result, the platform may serve this content to the user.

[0287] The mobile media platform may enable a mobile device to be used as a personal entertainment portal to a personal entertainment server or vice-versa. The mobile media platform may operate as a personal content portal that enables browsing functionality and featured content. The mobile media platform may support QuickPlays that may include predictive content recommendations, MyPlays that may include user subscribed preferences to content, popular plays that may be dynamically populated with content that is highly rated by a community of users, search integration, content ranking that may show a community ranking and allow a user to enter a ranking, deep linking to allow direct access to content rather than going through various affiliates or redirection so that a deep link may be sent to a friend or other mobile user.

[0288] A user may associate the mobile media platform with an interactive programming guide. Another way to view this is that the mobile media platform may generate a customized interactive programming guide for a user, such as based on the user profile, an associated consumption profile, or a device profile. The interactive programming guide may include combining broadcast and on-demand content and may be enabled by metadata tagging and inter-content relationships developed through application of user behavior algorithms, editorial control, and the like.

[0289] A mobile media platform may be associated with social networking or community aspects. Social networking aspects may include user content referral, user content rating, forums, gifting, buddy list management, peer-to-peer management, communities of interest, profile pages, dMail, points, message boards, newsletters, shopping, dynamic home page construction, advertising, notifications, and the like. User content referral may enable mobile users to inform other users about content through message transmission (e.g. SMS with a WAP push, MMS, email). When combined with buddy list management, message transmission may be directed to a subset of mobile users selected from the buddy list. Social network or community ratings may allow users to

rate a piece of content after the user has listened to or viewed the content on the user's mobile device. Community ratings may be based on a scale such as a star scale (where more stars may mean a higher rating). Community or other user ratings may be used (such as through an averaging algorithm) to drive popular plays and other content discovery mechanisms.

[0290] Social networking aspects of a mobile media platform may facilitate forums, such as forums related to content. Forums may provide facilities for users to conduct online conversations with other forum members. Forums may be standalone or may be integrated with existing web-based forums or blogs. A forum may provide private access to content for forum members. The mobile media platform may support forum membership through allowing forum members to invite other mobile users to join the forum or to join a topic based private conversation of forum members. Alternatively, private messaging features associated with the mobile media platform may be useful to communicate between forum members and other mobile users. Messages may be communicated via SMS, email, private forum pages and the like.

[0291] Although not limited to social networking environments, gifting may be facilitated by social networking aspects of the mobile media platform. In an example, a user may send content to another user as a gift so that the sending user is billed for the content and perhaps for the gifting service. Similarly, a user may request a gift, such as from a community member who may be soliciting requests for content gifts.

[0292] Buddy list management is an integral part of social networking and on-line communities. The mobile media platform may allow a user to build and manage a list of other mobile users as a buddy list. The mobile media platform may also allow a user to classify buddies into groups.

[0293] In addition to gifting and message based content sharing, peer-to-peer management may facilitate sharing content via one or more servers, such as mobile media platform servers, network servers, third party servers, and the like. To manage peer-to-peer sharing, shared content may be tracked through the mobile media platform so that digital rights management, billing for content, and the like may be managed. Paying for shared or gifted content may be done through a direct bill to the user's mobile service provider account, a credit card for per-use or subscription services, or through a third party payer service such as PAYPAL.

[0294] Social networking may also be beneficial to the formation and management of communities of interest. The mobile media platform may support communities of interest through user registration. Users may be placed into specific communities automatically or through a selection of interests. Additionally, communities of interest may be organized along sets of criteria which can be used to determine eligibility. Communities may also have voting for special members of the community. This may be reflected graphically in an avatar representation of the member. This representation may make it obvious who are the voted community tastemakers, trendsetters, power brokers, brand strokers, persuasive influencers, and the like.

[0295] Profile pages may be users' individual spaces in a community. Each user may get one that they may customize. The mobile media platform may provide services that allow a user to import appearance skins that they may customize with a slide show, quote, favorite link, and the like. Profile pages may derive information from a user profile associated with the mobile media platform and may include blog links, bookmarks of favorite content, interests, buddy lists and friend

connections and the like. Interests may be published and provide the ability to see a list of people who share them. People may be added to friends' lists as well as see who has marked them as a friend in return.

[0296] An internal community email system may permit message sending within a specific community or across a service.

[0297] The mobile media platform may facilitate earning, reporting, and redeeming points associated with mobile media platform based activity related to the social networking community A user may, by participating in a community in different ways earn points. In an example, a user may earn points for playing games, blog posting, posting messages in message boards, and the like. Points may accumulate for individuals or groups of individuals. Points may be redeemed and prizes may be presented to high point earners. Point ratings may be presented on a user's home page; may be included in content or messages originating from a high points earner, or in association with an avatar so that other community users may identify these users.

[0298] Social networking also typically includes message boards that may be themed to provide an opportunity to communicate openly within a community to share ideas relevant to the community, newsletters in which users may contribute articles and images for consideration to be included in a periodical newsletter, shopping through interactive storefronts with themed merchandise that can be purchased, advertising that may be built into various aspects of the community to support features, notifications that a user may receive about different things happening related to the community. The homepage may change every day to reflect additions to the service, and draw users' attention towards what's new, what's hot, and so on. Users may also share content and their experiences with other users. Users may be able to express their opinion on the content in the form of rating (one to five stars) and tagging (e.g., for a clip categorized under extreme sports, a user could add their own community tags of hang gliding, crash, scary). They may also recommend content to their friends and other users and see what content their friends, peers or the user population as a whole are watching and recommending. A user may place a link to mobile content on a Web 2.0 site.

[0299] Content may be shared on mobile devices as an aspect of social networking. In an embodiment, this may enable sharing of viral videos. In an embodiment, this may result in the use of an email inbox as a content portal on mobile devices, such as mobile smartphones. In an embodiment, an email may be sent from one user to another containing content and/or links to content. A user will be able to send such an email to another user even if the other user is on a different network or is using a different device. In an embodiment, an email may contain notification of new content and may contain the content and/or links to the content. In an embodiment, content may be pushed to the mobile device at an off-peak time. The inbox may receive content in the same way that email messages are received, such as an over-the-air push, rather than on-demand. In embodiments, user profiles may be used to store notification preferences and awareness of which users are participating in the system. In embodiments, user profiles may also enable the platform to send a user customized content.

[0300] In a certain embodiment, such as the embodiment of FIG. 20, the mobile device may be a blackberry device. A blackberry device may have the capability to receive and

display HTML emails. The mobile media platform may be configured to send HTML emails to these devices. This may allow the user to receive emails which contain hyperlinks that are more graphically pleasing than normal emails. A blackberry device may support the JSR 211 ContentHandler API which may allow a mobile application to be associated with certain types of content, allowing the mobile application to launch when the user opens that type of content. A blackberry device may contain a MailListener API, which supports scanning the Inbox for email messages which meet certain criteria. As an example, a mobile application could listen for emails arriving which contain a certain subject, and perform some action when it arrives. A blackberry device may contain an API to display small notification icons on the main screen of the device. A blackberry device may contain an API to embed a media player within a mobile application, so that users can watch videos inside applications, as well as through the built-in media player that comes with the device. In relation to sharing content on mobile devices, the mobile media platform may have the ability to store personalization information about a unique user, including user notification preferences and contact information, to send HTML-formatted emails and to configure the MIME-type which may be returned with custom HTTP requests. In a certain embodiment, the mobile media platform may notify a user when new content is available and present the user with the new content and/or a link to the new content via email. The user installs a mobile application on their mobile device, which registers itself as the handler for a particular MIME-type. The user uses the application to communicate their notification preferences to the mobile media platform; for example, notify me about new sports videos. The mobile media platform sends the user emails when new content is available to view. These emails may contain a hyperlink to a small file on the mobile media platform. The mobile media platform may be configured to return these small files with the same MIME-Type for which the application was registered. The user receives the email, and clicks on the link to the small file. The email is an HTML email, and therefore the actual file being downloaded is masked from the user by a pretty hyperlink. The application may scan the inbox for these notification emails, and display a customized notification icon when these special emails arrive. The application launches, downloads the small file, which contains a mapping to a particular video to play back to the user. The application then plays the video.

[0301] In a certain embodiment, one user may send content to another user using the technique described above for the platform to notify the user of new content, however, the email may be initiated differently. An application may permit a user to send a video to a friend, making a request to the mobile media platform, which sends an email to the appropriate person. If the recipient already has the application installed, then the behavior may be identical to that described above, including the display of notification icons. If the recipient does not have the application installed, the email can provide them with a link to download the application or another means of accessing the content.

[0302] The mobile media platform may facilitate carrier management. The mobile media platform may be associated with ecommerce such as billing, pricing, event tracking, bundling, tiered services, content purchase (e.g. individual pieces, collections, subscriptions), discounts, free services and content, multimedia advertising delivery and monetization. In an embodiment, a subscription may be to certain

content and certain additional content is identified as premium content outside the subscription plan and the user has to pay extra to access this content. The platform may also allow users to preview content (such as a music video) or try/demonstrate content (such as a game) before the user purchases the content.

[0303] Billing price plans may be tightly associated with specific content that may be associated in a content catalogue layout whereby, the billing price plan defines access to content (e.g. a single content item, multiple content items or a group of categories each containing content items). Pricing complexity and flexibility may be supported by nesting billing price plans and otherwise combining simple price plans.

[0304] Billing price plan definitions may be used in various billing models. Examples of billing models include:

[0305] Pay Per Duration—Users can pay for access to content (a single content item, multiple content items or a group of categories each containing content items) over a period of time.

[0306] Subscription—Users can pay a recurring charge for access to content (a single content item, multiple content items or a group of categories each containing content items).

[0307] Pay Per Use—Users can pay a one time fee for consumption of content, such as a single item of content, a library of content, a subset of content, and the like.

[0308] The mobile media platform may enable digital rights management. The mobile media platform may permit the administration of rights in a digital environment. The mobile media platform may allow rights holders to track and receive compensation for use of their content and other intellectual property. The mobile media platform may adapt the implementation of digital rights management to different carriers.

[0309] The mobile media platform may also provide reporting facilities, such as transaction logs, event logs, digital rights and virtual property use and consumption royalties and recommendation reporting. Reports may be generated and/or accessed through a web interface.

[0310] The mobile media platform may facilitate mobile media platform related administration. Administration may include managing users, user account management, administrator user account management, preference management, server side and client side management, mobile media platform management, user profiles, user registry, carrier profiles, consumption profiles, device profiles, encoding and transcoding features, and the like. Mobile media platform management may include monitoring and configuring the operation of the mobile media platform, management reporting, system performance monitoring, content management, pricing management, and the like. User profiles and management may include profile management components that each user may create and customize with their preferences and settings on an ongoing basis. User registry management may include global user profiles, user application preferences, extensibility management, managing a unique user identity (and/or classification of a user to a category of users) within or across mobile networks and/or associating a mobile network profile with a fixed web based profile. Profiles similar to user profiles may be maintained for carriers. The user interface may be extensible. Applications can use this information to determine the most appropriate content and delivery method, providing a personalized user experience. A user identifier can be unique within a mobile network or potentially across

mobile networks or extending to a fixed web based profile. A user identifier can be a category of users.

[0311] In a certain embodiment, the mobile media platform may provide a user interface for content management, including administrative aspects of content management. Referring to FIG. 21, the content management user interface may be provided as the content tab of a larger user interface. The user interface may allow a user to select content, view content, manage parameters and attributes of content, create a content index or queue, move content, copy content, remove content, filter content, order content and the like.

[0312] In a certain embodiment, the mobile media platform may provide a user interface for reporting, including administrative aspects of reporting. Referring to FIG. 22, the reporting user interface may be provided as the reporting tab of a larger user interface. The user interface may allow a user to generate reports for certain data ranges with certain filters applied.

[0313] In a certain embodiment, the mobile media platform may provide a user interface for ingestion management, including administrative aspects of ingestion management. Referring to FIG. 23, the ingestion management user interface may be provided as the ingestion tab of a larger user interface. The user interface may allow a user to schedule ingestion from a particular source at a particular time or on a particular schedule. The user interface may allow a user to pause ingestion. The ingestion management user interface may also include tabs, menus and/or pages for job queue, listeners, profiles and components. Referring to FIG. 24, components may include components for encoding with associated profiles.

[0314] In a specific embodiment, the ingestion user interface may be as described in FIGS. 25 through 40. Referring to FIG. 25, the main ingestion page may provide links to all the key ingestion-related functions. FIG. 26 depicts how feeds may be viewed and managed. With this interface a user may choose a provider from the dropdown that contains the providers in the system. Once a user chooses a provider from the dropdown, the page refreshes to display FIG. 27, which is populated with information specific to the chosen provider. This page may contain a table which contains the feeds that have been set up for the provider. The table may display the feed name, type, and the first 40 characters of the URL/path (truncated and with an ellipsis appended) and the like. The name may be linked, and may take the user to the "EDIT FEED SUMMARY (page 8/8)" page. This table may be sorted alphabetically by name. Each row of the table may be preceded by a checkbox. The table may contain a DELETE SELECTED button. Clicking this may refresh the page, and delete the checked rows. When a user clicks "ADD NEW FEED" the user is linked to the "ADD FEED WIZARD (page 1)" page as shown in FIG. 28. This is the first page of the Add Feed Wizard. It prompts the user to enter the feed type and feed name. It may also display the feed provider as uneditable text. The wizard may contain a subnav down the left side of the page. When ADDING a new feed, this subnav may contain the title of each page in the wizard, and also may give the user an indication of how far along they are in the wizard process. Items in this subnav can be in many states including: greyed text+unlinked (future step); bold+unlinked (current step); and normal text+linked (past step). The user may be able to click on a "past" link and go back to that step in the wizard process. When the user is EDITING an existing feed, the subnav may function as tabs, to navigate from one area of

the feed to another. In that case, all of the items in that area may be links. Every page of the wizard may have the "BACK", "NEXT", FINISH and "CANCEL" buttons. On the first page, the "BACK" button may be disabled, on the last page the "NEXT" button may be disabled. During ADD, the FINISH button may be disabled on every page but the final one, and during EDIT it may be active on every page. Clicking NEXT and BACK buttons may maintain any information that the user has entered thus far (ie: if they click back then next, the data they entered on a particular page should still be there). However, the feed may not truly exist within the system until the user presses FINISH at the end, to commit the changes.

[0315] FIG. 29 depicts the second page of the feed wizard, which may allow a user to select the category labels that will be associated with the feed. The majority of this page may be occupied by a Fieldset, which allows the user to add multiple category labels to the feed without navigating on to the next page of the wizard. The user can enter a label, and then select the Carrier. Once they've selected the Carrier, the Product Dropdown may populate with the products attached to that carrier. This dropdown may contain both the product name and version number. The user selects this, and the category control may populate with a tree view. Users then may pick a category to associate with the label. Clicking "ADD LABEL" will then add this pair to the list of labels below. Beneath the "ADD" button, there is a list of all the labels that have been created for this feed. The list is sorted by label name, and the sort order may not be modified in certain cases. Each label may have a checkbox next to it. The user may click the checkboxes and then press "DELETE SELECTED" to remove labels from the list. All actions within the fieldset may either function via javascript or may simply refresh the page with the new information. In this particular embodiment, at least one category code must be created before the user is allowed to proceed to the next page.

[0316] FIG. 30 depicts the interface allowing a user to choose the publication rules for the feed. "Simple" and "Batch" publication may be two of many methods. Both SIMPLE and BATCH publishing methods may cause clips to be placed "FIRST" in the category. The user may also choose the default category for clips to be placed in, in case the content provider does not specify where they should go. This may be a dropdown containing a list of all the CATEGORY CODES that were created during STEP 2. FIG. 31 depicts the interface allowing a user to set the ingestion schedule, which is the schedule that may be used to both check the feed and publish the content. As shown in the figure, the user may also specify other options using the interface. In this embodiment, the first run of the feed's publication schedule should be set for a future time. If the user chooses the options in such a way that the "first" scheduled update time occurs in the past, then the system should compute when the first "future" run will be, based on that time, and schedule it as the first run instead, rather than trying to run a backlog of multiple jobs at once. For example, the current time is August 13, 13:54 and the user schedules things to run every half hour, starting at 12:30 (a typo). The first run should be scheduled for 14:00. It may be that the Start Time is changed before being saved, so that it appears this way when the user returns to this page.

[0317] The interface shown in FIG. 32 may allow a user to type in the feed URL of the feed and the encoding type to expect. There may be a PERFORMENCODING? Checkbox, which may be checked by default. If this is unchecked, the

“FIRST ENCODING PASS” dropdown may become disabled. The “FIRST ENCODING PASS” dropdown may contain all the encoding profile names. If the feed is of type RSS, then the user may type in a URL. If the feed is of type QAR, then the user may type in a PATH. The text should may change appropriately. Also, with QAR, the “SECURE FEED” controls may not need to be displayed. The field on this page may be skipped in certain cases. For example, when a separate feed setup exists.

[0318] The interface shown in FIG. 33 may allow a user to customize the encoding profiles that are being used for this feed. “Default” encoding profiles may be set up in the system (see “manage encoding profile” pages), but these may also be customized. The controls in the second fieldset allow for customization. A dropdown may appear, containing the name of each profile. Selecting a particular item in the dropdown may populate the profile in the text area. The user may then modify it there. Clicking save may cause the overridden profile to be associated with this feed for that encoding profile. When a profile has been over-ridden, it may appear in the dropdown with an asterisk (*) pre-pended to its name. Additionally, when the user views this profile, the “RESTORE DEFAULT” button may be enabled. Clicking this button may delete the over-riding version, and restore the default profile. The text areas may simply contain the XML profile but may also specify encoding profiles. The dropdown may be filtered to contain profiles which are being used for a particular feed. The “First Pass” encoding (as chosen during a previous step) may appear here, as will the OUTPUT encodings, which are algorithmically determined based on the user’s category choices.

[0319] The interface shown in FIG. 34 may summarize the details of the feed that have been set up by the user. It may also be the page that a user arrives at if he chooses to EDIT an existing feed. Once a new feed has been saved FIG. 35 may be shown. This interface may provide intelligent navigation options including MANAGE THIS FEED which may displays the FEED SUMMARY screen and ADD ANOTHER FEED which may return to the first page of the ADD NEW FEED WIZARD.

[0320] FIG. 36 displays the ingestion schedule for every feed in the system, which may not be a list of jobs, but a list of feeds. The list in the table may contain the following columns: a checkbox, to select that row; feed provider+feed name (this text may be linked); feed schedule (plain English); last execution date and time; next execution date and time; and pass? (which is an indication of whether the last ingestion ran successfully, or not). The list may be ordered by “next execution date and time”, ascending (ie: soonest first). There may be a maximum 20 rows that can be displayed at a time, with pagination at the bottom of the table if more feeds are scheduled. When a particular feed is “paused”, then the word “PAUSED” may appear beneath the NEXT EXECUTION column. If the job is running, it may say “RUNNING”. All “paused” feeds may appear last in the list due to the sort order. If a feed has not run yet, then its LAST EXECUTION column may be blank. Clicking on the Provider+Feed link may link to the appropriate “EDIT FEED” page. Beneath the table there may be a dropdown which can be used to perform actions on the feed. This dropdown may contain the following values: RE-RUN IMMEDIATELY, PAUSE and UNPAUSE. Each of these actions may cause the action to happen on the selected feeds immediately, and may cause the page to refresh with the new data.

[0321] The user interface of FIG. 37 may be used to add a new encoding profile. The fields may include NAME and CONFIGURATION. The “Configuration” text field may contain an XML profile. After SAVE, the user may be shown a confirmation message at the top of the page (as displayed). Clicking cancel may return the user to the page they were just at, without saving anything. Once a new profile has been saved, FIG. 38 may be shown. This interface may provide intelligent navigation options, including MANAGE THIS PROFILE (which may display the MANAGE PROFILE screen with this price code selected in the dropdown and its information pre-populated in the fields) and ADD ANOTHER PROFILE (which may return to the ADD NEW PROFILE screen with blank fields ready to be filled in).

[0322] FIG. 39 may be the user interface a user arrives at when they choose to manage an encoding profile from the main ingestion page. A user may be able to select an existing profile from the dropdown. This may refresh the page with the details for that particular profile. The user interface of FIG. 40 may be used to edit an existing encoding profile. User interface fields here may include NAME and CONFIGURATION. The “Configuration” text field may contain an XML profile. After SAVE, the user may be shown a confirmation message at the top of the page (as displayed).

[0323] Content may be advertisements, marketing materials and the like. The content may be an interstitial advertisement, banner ad, in stream ad, ad placed in the content itself, ad framing the content, an ad appearing before or after the content and the like. Advertisements may be placed into pods. Advertisements may be clustered and positioned, such as within, adjacent to, in front of and behind other objects. Advertisements may be inserted into other content, such as mobile content. Insertion of advertisements may take place with both a thin client and a rich client. An advertisement may be interactive allowing a user to access additional information and content by clicking on or otherwise interacting with the ad or aspects of the ad. An advertisement may be associated with one or more related or companion advertisements. In an example, a user may click on an ad and be shown a companion ad. An advertisement may be associated with one or more prohibited advertisements that may not be shown near in time or space the advertisement. For example, ads for a competitor of an advertiser may be negatively associated with the advertisements of the advertiser, and not permitted to be shown on the same screen or within one hour of delivery of an ad for the advertiser. Ads may be automatically tagged to facilitate delivery, targeting, interaction, impression measuring and the like Ads may be ingested, tagged, encoded, transcoded and the like in a manner similar to other types of content.

[0324] The mobile media platform may be associated with advertising management. Advertisements may be managed and served within the platform, or through integration with advertisement management systems, such as those of a content provider. The mobile media platform may contain various user interfaces for management of advertising. There may be separate user interfaces for end users, advertisers, carriers and the like. Advertisement management may allow insertion of banner and interstitial advertisements into mobile applications, such as through thin and rich clients. Advertisements may be managed and served within the mobile media platform or through integration with content provider advertisement managerial systems. In an example, advertisements may be organized into advertising pods, cluster advertising,

and the like that may be placed next to, in front of, or behind other content objects delivered to a mobile user by the mobile media platform.

[0325] The mobile media platform may be associated with targeted advertising. In an embodiment, a consumption profile may facilitate targeted advertising. In another example, one possible method to support targeted advertising may include analyzing a user's consumption profile and determining common genres that the user may like. This information could be used in third party ad-server integration for targeted advertising. In embodiments, data about the user and user preferences may also be used to facilitate targeted advertising. In embodiments, location information and location intelligence may also be used to facilitate targeted advertising.

[0326] Social networking may be associated with advertising on the mobile media platform. Content and related advertisements may be referred through the social networking aspects of the platform. Ad spaces and sponsorships may be built using the platform. The mobile media platform may be associated with an ad fulfillment engine. The ad fulfillment engine may use techniques for targeting and delivery of ads to fulfill certain advertising related objectives. Objective may include one or more of delivering a certain number of ads, delivering ads to a certain demographic of users, delivering ads for a certain advertiser, delivering ads during a certain time period and the like. The ad fulfillment engine may generate or be involved in the generation of reports regarding the delivery and consumption of advertisements and other content. The ad fulfillment engine may interface with, assist or be assisted by the settlement and mediation processes of the mobile media platform.

[0327] The Mobile media platform may include a security facility and security functionality, which may include authentication, authorization, passwords, purchase verification, access control, biometric identification, encryption and the like. Security may be directed at securing access to the platform and may also be directed at protecting the content and information of the platform, such as during data transfers.

[0328] A variety of billing systems may be supported by and facilitated by the mobile media platform. Usage collection may provide a mechanism to collect relevant information related to the consumption of content and store it in a central location for billing and reporting purposes. Pricing for billing may enable establishing pricing for content to allow an advice of a charge for access to or consumption of the content prior to the access or consumption. Pricing may be set locally or can be established via integration with content provider or mobile operator product catalogues or billing systems.

[0329] Billing price plans may be tightly associated with specific content that may be associated in a content catalogue layout whereby, the billing price plan defines access to content (e.g. a single content item, multiple content items or a group of categories each containing content items). Pricing complexity and flexibility may be supported by nesting billing price plans and otherwise combining simple price plans.

[0330] Billing price plan definitions may be used in various billing models. Examples of billing models include pay per duration and subscription, among others. In pay per duration a user may pay for access to content (a single content item, multiple content items or a group of categories each containing content items) over a period of time. In a subscription model, a user may pay a monthly recurring charge for access to content (a single content item, multiple content items or a group of categories each containing content items).

[0331] Operator billing facilities may be provided for billing consumers via their mobile operator. Off-portal billing may allow the integration of credit card clearing houses, third party payment systems such as PAYPAL, and the like to pay for billed services. Billing services may be integrated with loyalty programs associated with the mobile media platform so that users of the mobile media platform may be rewarded for their loyalty through frequent buyer discounts, special offers, tiered levels of service, and the like. Billing may also be integrated with mobile operator billing systems to include content pricing queries, IPDR direct content billing channels, SMPP premium SMS billing channels, proprietary web services (e.g. AMDOCS), carrier BSS and/or OSS. Billing may also use a percent of billing event methodology and/or a data charge based the amount of bandwidth consumed by the delivery of a piece or collection of content. A charge can either be a bulk (wholesale) purchase of the right to send and receive a certain amount of data on a mobile telecom providers network or it may be an individually metered data transaction.

[0332] The mobile media platform may be integrated with other systems by various methods of integration. Other systems may include carrier systems, content provider systems, systems of mobile devices, ad servers, Internet-based systems, web-based systems, billing systems, content delivery systems, encoding and transcoding systems, storage systems, social networking systems, hosting systems, ingestion systems, security systems, search engines, mobile search engines, device providers, and the like. The platform may integrate with companies and/or systems that provide services and devices, such as APPLE (IPHONE, ITUNES), YAHOO (e-books, reader device), VERIZON (phones and services), and the like. Methods of integration may include hard coding, loose coupling, over a network, using application programming interfaces, using interfaces and the like.

[0333] General architecture aspects of the mobile media platform are disclosed through this specification and may include, without limitation, any of the following: application layer (J2ME, BREW, WAP, HTML, etc), a business module including a content facility layer for fulfillment and hosting, a commerce facility layer for merchandising and billing, a culture facility layer for communities and personalization, a component layer with modules and/or facilities that include search interface, digital rights management, loyalty programs, partner management, a registry of the parties involved in the creation and delivery of content, and the revenue sharing relationship between the parties. Revenue shares may be determined, and facilities may be provided for revenue reconciliation between the various entities, peer-to-peer management, buddy list management, browser interface, streaming service, off-portal billing, customer service representatives, self-care management, content filter management, gifting, encoding, transcoding, download service, operator billing, advertisement manager, notification management, forum/blog/rant, content ingestion, device management, pricing, management console, profile management, user content rating, content management, delivery management, usage collection, storefront, user registry, user content referral, and the like. The mobile media platform may also or alternatively include a system layer with a component management architecture, a thin client or a thick client mode, device registry, and the like.

[0334] The mobile media platform may be usefully and beneficially applied to a wide variety of applications. Addi-

tionally, the platform may provide a wide variety of applications related to mobile media methods and systems. Applications of the platform may include branding; increasing brand strength, e-commerce, channels, games, purchasing platform, home shopping network, digital distribution, distribution channels, creation of communities, social networking, web browsing, creation of a portal, targeted advertising/marketing, advertisement fulfillment engine that may use data about the user and user preferences, and store front applications. This sample descriptive list of applications that may be associated with the mobile media platform is not intended to be limiting.

[0335] FIG. 41 depicts one particular embodiment of a video content hosting process. A content provider 4102 may provide the content, such as a video file 4104, along with metadata in XML format 4108. The platform may include a content requester 4110, metadata processing engine 4112, video transcoding engine 4114, processed metadata 4118, formatted video files 4120, metadata assignment 4122, archive files 4124, a categorization facility 4128 and a publication facility 4130. FIG. 41 depicts the use of descriptors defined in XML to wrap content and tag it into the platform. Content may be aligned by device, so that common infrastructure will service the needs of a carrier's network; for example, for a particular carrier all of their core networks, such as EVDO, iDEN and CDMA may be supported.

[0336] Referring to FIG. 42, the client application architecture may enable a device independent rich user experience, a proprietary or other communications protocol and ease of porting. The device independent rich user experience may use J2ME, BREW, WAP, RIM jde, SYMBIAN, Linux Mobile, WINDOWS and the like. The device independent rich user experience may use and/or enable embedded or proprietary players. The device independent rich user experience may use or enable business logic and/or sessions managed on a server. The device independent rich user experience may use or enable carrier specific network and handset logic, such as handset capability determination and delivery method determination. The proprietary or other communications protocols may enable in-background processes, optimization of bandwidth (client cache), application version checking, update notification and the like. Ease of porting may enable intelligent pagination, scalable graphics, dynamic custom fonts and the like. The platform may dynamically calculate the amount of text that can be shown and may dynamically render it instead of hard coding (pagination, graphics and fonts).

[0337] Referring again to Fig. BB23-3, the platform may contain a thin client portion and a firmware level for each device. Each device may have different firmware settings and hardware profiles, such as different screen resolutions, color depths, memory, memory handling and the like. The thin client aspect of the platform may facilitate interaction with the disparate devices and may allow for a framework where connectivity and applications can be built on top of the device. The platform may also contain a communications protocol which may permit initiation of more than one process simultaneously. The platform may also allow for optimization of bandwidth and cached content on the device. The platform may also enable the ability to upgrade the application in real-time once it is delivered to the market place. This may be advantageous as many users do not look for new versions, decline upgrades and/or are not sophisticated enough to complete the update process. Instead of hard coding pages, the platform may enable the dynamic calculation

and optimization of page sizes, font type and sizes, amount of text to display and the like based on properties of the device and the platform.

[0338] The platform may contain its own user interface layer which is built on top of the development platform for each device. This layer may be repeatable and may function as a library, such as a library of APIs, which can be leveraged across various platforms. In this regard, the platform may handle a wide range of devices, operators, networks and the like. This layer may also allow for depth of content, services, customization and the like.

[0339] A store front application associated with the mobile media platform may include a facility to market content to consumers via a number of channels, including interactive WAP, web, and mobile rich client applications, as well as SMS short code, and mobile bar code campaigns. The store front application may enable consumers to discover content, provide a means for content providers to highlight and display the valuable content to the user via product placement in the user interface through 'most popular' feature rotation and content grouping based on themes and providing interactive cues (e.g. "more like this"). A store front application of the mobile media platform may include a web interface that may be used by content management editors and the like to manage editorial content features, such as may be defined by special promotional or other business drivers. The mobile media platform may also include or function as a purchasing platform. The mobile media platform may enable or function as a mobile home shopping network. Through purchasing, shopping and storefront applications, among other applications, the mobile media platform may assist with branding and impact brand strength.

[0340] The mobile media platform may include or function as a portal, content portal or the like. The platform may include or function as a distribution channel, such as a content distribution channel, digital distribution or the like. In an embodiment, the platform may include or function as a retail channel, wholesale channel or the like.

[0341] Referring to FIG. 43, the mobile media platform may function as a syndication platform for content providers to enable their content to be delivered to end users via various distribution points, such as mobile operators or carriers like VERIZON and Bell mobility, Web 2.0 distributors like GOOGLE and YAHOO, device manufacturers like NOKIA and APPLE, content portals like MTV and CBS, retailers like AMAZON and WAL-MART.

[0342] Referring to FIG. 44, the mobile media platform may facilitate content providers reaching consumers, preparing their content for distribution, facilitating transactions, and the like through capabilities that support broadcast TV, radio, long form content, user generated content, video on demand, audio on demand, information gathering and presentation, and the like. Distribution points may provide mobile users with gateways to the content and the mobile media platform may deliver the content through the gateway or directly to the user through a referral from the gateway.

[0343] The mobile media platform may include, enable and/or facilitate games, such as mobile games. The platform may include or enable a gaming portal, gaming community or the like. A user may play a game on a mobile device. Games may be played over a network. The games may be single player games or multiplayer games. A game may include or be associated with one or more virtual worlds or real-world

communities. The platform may facilitate mobile game tournaments and allow users to share scores, in addition to playing against each other.

[0344] The mobile media platform may support and be associated with a wide variety of users who may interact with, benefit from, or otherwise have a relationship to the mobile media platform or to aspects of the mobile media platform. Representative users may include end users; consumers, advertisers, marketers, content providers, content owners, networks, broadcasters, media companies, mobile carriers, record companies, movie studios, regulators, mobile device designers, mobile device manufacturers, mobile device offerors, mobile service consolidators and affiliates, retailers, and the like.

[0345] The mobile media platform may be associated with various business models. Business models may include models for operating the mobile media platform, providing services associated with the platform, establishing business relationships with partners, capitalizing on market opportunities, protecting and promoting platform related intellectual property, internationalization, and the like. Mobile media platform related business models may include shared risk, shared reward, short code and bar code campaigns, white label/private label, payment and pricing models (e.g. subscription, per-use, pre-paid, post-paid, free trial, gifting, begging), distribution models (e.g. initiated on deck (i.e., via the operator's portal facilities), initiated off-deck (i.e., via non-operator portal), initiated via short code, initiated via viral distribution and the like), ad-supported models (e.g. bulk, per view, click-through, search keyword auction, ad media, banner ads, audio/video bumpers, splash screens, interstitials, location based), revenue share management (e.g. content provider, mobile operator), and the like. The mobile media platform may facilitate multi-vendor business models through mediation and settlement of mobile content events associated with content discovery, ingestion, encoding, syndication, notification, distribution, streaming, ad serving, and other capabilities of the platform. Mediation and settlement may further enable supporting complex business models as new participants, technologies, and content intersect with current business models. In an example, a business model may include giving end users free access to most mobile content and charging the user a fee for some specialized and/or premium content. This model may enable additional ad sponsoring arrangements to mitigate the end user charges associated with the specialized and/or premium content.

[0346] In embodiments, a consumption profile 102 may impact seamless switching among unicast, multicast and broadcast content 128 and between networks. In an embodiment, switching between broadcast and unicast/multicast content 128 may be facilitated by a consumption profile 102. In an embodiment, the network profile 208 may be used to facilitate seamless switching between two separate networks. The networks may differ in underlying technology. Networks may be GSM, GPRS, EDGE, HSDPA, UMTS, CDMA, CDMA 1x, EV-DO, Wi-Fi, WIMAX, UWB, BLUETOOTH, MEDIAFLO, DVB-H, DMB and the like.

[0347] In embodiments, a consumption profile 102 may be affected by and/or facilitate advanced encoding and/or transcoding 104. In an embodiment, parameters and attributes of advanced encoding and/or transcoding 104 may be determined by a consumption profile 102. The encoding profile may specify the parameters and attributes of encoding and/or transcoding. The network profile and device profile

may influence the attributes and parameters of encoding and/or transcoding so that the content 128 will be compatible and optimized for the network and device, respectively. The content 128 profile and user profile may also impact advanced encoding and/or transcoding 104. The content 128 profile and user profile may determine which content 128 is encoded and/or transcoded.

[0348] In embodiments, a consumption profile 102 may be affected by and/or facilitate automated content 128 tagging 108. Tags may be maintained as part of the consumption profile 102. The consumption profile 102 may also include information that impacts how tags are applied to content 128 and the types of tags that are applied to content 128. In embodiments, a consumption profile 102 may be affected by and/or facilitate pausing and resuming playback. Markers and the like associated with pausing and resuming 114 may be maintained as part of the consumption profile 102. The consumption profile 102 may also contain user preferences in connection with pause and resume. For example, a user may prefer that content 128 is paused when a mobile device enters standby mode, but not when a mobile device is powered off. In embodiments, a consumption profile 102 may be affected by and/or facilitate mediation and settlement 112. Information contained in the consumption profile 102 may be used to accomplish mediation and settlement 112. Mediation and settlement 112 may occur among content 128 providers, dealers, affiliates, distributors, advertisers and other constituents and users of the mobile media platform 100.

[0349] In embodiments, a consumption profile 102 may include information regarding content 128. The information may include the types of content 128, as described herein, and the sources of content 128, as described herein. In an embodiment, the consumption profile 102 may take into account the source of a request. For example, different parameters and attributes may be associated with a request for content 128 originating on a social networking or Web 2.0 website than for a request originating on a mobile device for dedicated video delivery. In an embodiment, through the consumption profile 102, the origin of a request may impact mediation and settlement 112 associated with the request. For example, a request initiated through a retail channel may be subject to different pricing terms than a request initiated through a Web 2.0 website. In an embodiment, the content 128 may be web content 130. As part of the consumption profile 102, web content 130 may be associated with specific encoding profiles and the network profile for web content 130 may only include a subset of all available networks. In embodiments, the user profile may include user preferences in connection with web content 130. For example, web content 130 may be associated with higher costs and bandwidth usage so a user may prefer to receive lower quality web content 130 or prohibit access to web content 130.

[0350] In embodiments, a consumption profile 102 may impact and be impacted by ingestion 118. In an embodiment, a consumption profile 102 may specify the ingestion parameters. In an embodiment, aspects of the consumption profile 102 may be specified as a result of ingestion 118. In embodiments, a consumption profile 102 may be hosted. In embodiments a consumption profile 102 may specify hosting 132 attributes and parameters. In embodiments, hosting parameters and attributes may be captured in a consumption profile 102.

[0351] In embodiments, a consumption profile 102 may impact the delivery of content 120. A consumption profile 102

may impact the content 128 that is delivered to a user. For example, based on user preferences, the consumption profile 102 may result in arts content 128 being delivered to a user over sports content 128. In embodiments, a consumption profile 102 may impact how content 128 is delivered to a user. For example, encoding and technical delivery parameters for certain types of content 128 as included in the consumption profile 102 may determine the network technology over and quality level at which an item of content 128 is delivered. In embodiments, a consumption profile 102 may determine when content 128 is delivered to a user. For example, based on historical user behavior which is included in the consumption profile 102, the mobile media platform 100 may provide morning news content 128 to a user at 9 am since the user historically accessed such content 128 at such time. In embodiments, a consumption profile 102 may be used to assist with the targeted delivery of advertisements to a user.

[0352] In embodiments, the ingestion, encoding, transcoding, hosting and delivery of content 128 may be optimized 134 based on a consumption profile 102. The consumption profile 102 may contain information which allows the mobile media platform 100 to optimize 134 the ingestion, encoding, transcoding, hosting and delivery of content 128. For example, in connection with delivery of an item of sports content 128, the network profile may contain information regarding the characteristics of the available networks, the device profile 202 may contain technical characteristics of the device and the user profile may contain the fact that the user prefers to view sports content 128 at the highest possible resolution and frame rate regardless of cost. Based on this information, the mobile media platform 100 may facilitate delivery of content 128 in satisfaction of all the parameters.

[0353] In embodiments, information contained in a consumption profile 102 may form metadata that is included with content 128 in a single file 138. In embodiments, metadata included in a single file with content 128 may form part of a consumption profile 102 and/or may correspond to information that is actionable based on the information included in the consumption profile 102. For example, based on network conditions and information in a consumption profile 102 it may be determined that an item of content 128 encoded at 20 frames per second is optimal for delivery. The metadata included as part of a single file 138 containing content 128 may include information regarding the frame rate, allowing for the selection and delivery of content 128 with the optimal frame rate. In embodiments, a consumption profile 102 may be stored, such as in a storage 122 facility.

[0354] In embodiments, a consumption profile 102 may impact one or more user interfaces 140 of the mobile media platform 100 and/or a mobile device. In an embodiment, a consumption profile 102 may impact the look and feel of a user interface 140, including skins applied to a user interface 140, sliders provided as part of a user interface 140, the speed and sensitivity of the user interface 140 and the like. In an embodiment, the consumption profile 102 may impact the menus and/or tabs of the user interface 140, including the order and presence or absence of certain tabs, menus and menu items. In embodiments, a consumption profile 102 may impact rendering of a user interface itself, in addition to content 128 accessed through the user interface 140. In embodiments, a consumption profile 102 may impact the content 128 provided on a start-up screen and the types of information that are prominently displayed in a display. In an embodiment, one or more consumption profiles 102 may be

managed through a user interface 140. In embodiments, messages, notifications and alerts may be provided in connection with a consumption profile 102.

[0355] In embodiments, content 128 discovery may be impacted and facilitated by a consumption profile 102. In an embodiment, a consumption profile 102 may impact searching. In an embodiment, a consumption profile 102 may be used to rank, filter and cluster search results. In an example, a user profile which favors sports content 128 may result in a higher ranking for content 128 search results for the Blue Jays baseball team than for the birds when a user searches for "blue jays" for his or her mobile device. In an example, search results may be filtered based on a device profile to exclude content 128 that cannot be accessed on a particular device. In an embodiment, a consumption profile 102 may be used to present recommendations. In an embodiment, recommendations may be based on a consumption profile 102. For example, recommendations may be made based on user preferences. In an example, a user profile may list a favorite sports team and the mobile media platform 100 may recommend to the user new content 128 relating to that team as it becomes available.

[0356] In an embodiment, location information and location intelligence 148 may be included in a consumption profile 102. In an embodiment, the location information and location intelligence component of a consumption profile 102 may be used to rank, filter and cluster search results, recommend content 128, target advertisements and the like. In embodiments, a consumption profile 102 may enable personalization of user experience 152. A consumption profile 102 may include user preferences allowing the platform to ensure that the user experience is personalized to these user preferences. In an embodiment, the mobile media platform 100 may include a personal entertainment server and/or interactive programming guide and the content 128 recommended through the server and/or guide may be influenced by a consumption profile 102.

[0357] In embodiments, a consumption profile 102 may impact social networking 150 and social networking aspects of the mobile media platform 100, including content referral, content rating, gifting, forums, gifting, buddy list management, peer-to-peer management, communities of interest, profile page, dMail, points, message boards, newsletter, shop, home, advertising, notifications, sharing content 128 on mobile devices and the like. In an embodiment, user content 128 rating may take into account consumption profiles 102 associated with various users. The ratings for a particular item of content 128 provided to a user may be weighted for similarities between that user's consumption profile 102 and the consumption profiles 102 of the users who rated the content 128. For example, if users with a particular device profile rated the content 128 as poor and users with a particular device profile rated the content 128 high, then a user with a device provide similar to the first group should be informed that the content 128 received a low rating, not a medium rating. In embodiments, a consumption profile 102 may contain user preferences regarding opting in or out of certain social networking aspects. For example, a user may elect to maintain privacy of the content 128 the user has viewed and not have his viewing behavior included in even aggregate public data.

[0358] In an embodiment, a consumption profile 102 may impact e-commerce 154 and e-billing aspects of a mobile media platform 100. In an embodiment, a consumption pro-

file **102** may be integrated with digital rights management. In an embodiment, a consumption profile **102** may include information relating to user preferences regarding digital rights management **158**. In an embodiment, a consumption profile **102** may include information relating to a device profile in respect of digital rights management. For example, the device profile for a particular device may indicate that it does not support digital rights management. As a result the mobile media platform **100** may restrict certain content **128** subject to digital rights management from being provided to the device. In embodiments, a consumption profile **102** may include information from various reports generated by the mobile media platform **100**, including transaction logs, event logs, royalty reports, recommendation reports and the like. In an embodiment, the platform may generate reports based on one or more consumption profiles **102**, in whole or in part. In embodiments, a consumption profile **102** may be managed through an administrative user interface. In embodiments, a consumption profile **102** may impact the administrative aspects of a mobile media platform **100**, including account management, preference management, client and/or server management, profiles, registries, and the like.

[**0359**] In embodiments, a consumption profile **102** may impact advertising **164**. Aspects of a consumption profile **102** may be used to target advertisements. For example, advertisements for device accessories may be targeted based on the device profile. Advertisements for businesses located close to the user's home and place of employment may be targeted based on user biographical information included in the consumption profile **102**. Advertisements for particular content **128** may be targeted based on a user's past viewing behavior as captured in the consumption profile **102**. Referring to FIG. **45**, in embodiments, an ad fulfillment engine **4520** may utilize information provided in the consumption profile **102** to deliver and target content **128**, including advertisements **128**, to certain mobile devices **4528**. For example, an advertising objective of the ad fulfillment engine may be to deliver a certain number of ads, to a certain demographic of users, for a certain advertiser, during a certain time period. The ad fulfillment engine **4520** can use consumption profiles **102** to determine the demographic of certain users and to tailor the delivery of each ad.

[**0360**] In embodiments, a consumption profile **102** may impact the security **168** aspects of the platform, including authentication, authorization, passwords, purchase verification, access control, biometric identification on the mobile device, encryption, access security and the like. In embodiments, a consumption profile **102** may impact the billing aspects of the platform, including collection, pricing, billing, mediation, settlement, reporting and the like.

[**0361**] In embodiments, a consumption profile **102** may enable and/or facilitate integration with other systems **172**, including carrier systems, content **128** provider systems, systems of mobile devices, ad servers, Internet-based systems, web-based systems, billing systems, content delivery systems, encoding and transcoding systems, storage systems, social networking systems, hosting systems, ingestion systems, security systems, search engines, mobile search engines and the like. Integration may be accomplished using hard coding, loose coupling, over a network, using application programming interfaces, using interfaces and the like.

[**0362**] In embodiments, aspects of the architecture **174** of a mobile media platform **100** may be captured in a consumption profile **102**. In embodiments, the consumption profile

102 may include information relating to one or more of the application layer, business module layer, system layer, thin client, rich client, device registry, component layer and the like. In embodiments the consumption profile **102** may contain detailed information regarding the architecture of the platform. For example, in connection with the peer-to-peer management aspect of the component layer, the consumption profile **102** may contain detailed information regarding buddy list management, browser interface, streaming service, off-portal billing, customer service representatives, self-care management, content **128** filter management, gifting, encoding, transcoding, download service, operator billing, advertisement manager, notification management, forum/blog/rant, content **128** ingestion, device management, pricing, management console, profile management, user content **128** rating, content **128** management, delivery management, usage collection, storefront, user registry, user content **128** referral and the like.

[**0363**] In embodiments, a consumption profile **102** may be associated with purchasing, shopping and store front applications **178**. In embodiments, a consumption profile **102** may be associated with various channels of the platform, including distribution channels, wholesale channels, retail channels, mobile operators, web 2.0 sites, device manufacturers, content providers, retailers and the like. In embodiments, a consumption profile **102** may be associated with games.

[**0364**] In embodiments, a consumption profile **102** may be associated with various users of the platform **184**, including end users, consumers, advertisers, marketers, content providers, content owners, networks, broadcasters, media companies, mobile carriers, record companies, movie studios, regulators, mobile device designers, mobile device manufacturers, mobile device offerors, mobile service consolidators, affiliates and the like. Types of users may include content providers, content consumers, infrastructure providers, facilitators and the like. In embodiments, each user of the platform may have its own consumption profile **102**. In embodiments, a given consumption profile **102** may contain information relating to various users of the platform.

[**0365**] In embodiments, a consumption profile **102** may be associated with various business models **160**, including short code and bar code campaigns, white label, private label, subscription, per-use, pre-paid, post-paid, free trial, gifting, begging, distribution initiated on deck, distribution initiated off-deck, distribution initiated via short code, viral distribution, ad-supported models (such as bulk, per view, click-through, search keyword auction, ad media, banner ads, audio/video bumpers, splash screens, interstitials, location based and the like), revenue share management, content provider, mobile operator and the like. In embodiments, each business model may have its own consumption profile **102**. In embodiments, a given consumption profile **102** may contain information relating to various business models.

[**0366**] In embodiments, switching between broadcast and unicast/multicast content may be associated with advanced encoding and/or transcoding. In embodiments, encoding and transcoding for broadcast content may differ from encoding and transcoding for unicast/multicast content as discussed herein. For example, unicast/multicast content may be pre-encoded, such as based on a schedule, or may be encoded on demand. Broadcast content may be encoded in a live linear manner taking into consideration the network, device, delivery method, available bandwidth and the like. In embodiments, switching between broadcast and unicast/multicast

content may be associated with automated content tagging. In embodiments tags may be used to associated broadcast and unicast/multicast content.

[0367] In embodiments, switching between broadcast and unicast/multicast content may be associated with pausing and resuming playback. In an embodiment, the playing of broadcast content may be paused while unicast/multicast content is accessed. The broadcast content may be later resumed. In an embodiment, the playing of unicast/multicast content may be paused while broadcast content is accessed. The unicast/multicast content may then be later resumed. In embodiments, switching between broadcast and unicast/multicast content may be associated with mediation and settlement. Mediation and settlement may occur among content providers, dealers, affiliates, distributors, advertisers and other constituents and users of the mobile media platform. Media data records may be generated for broadcast and unicast/multicast content. Media data records generated for broadcast and unicast/multicast content may be aggregated and normalized. In embodiments, the content may be advertisements and mediation and settlement may involve payment by certain advertisers to other constituents and users of the platform. In embodiments, the content may be creative content and mediation and settlement may involve payment to certain content owners and providers.

[0368] In an embodiment, at least one of the broadcast and unicast/multicast content may be web content. The content delivered to the mobile device may be sent from the web or be sent to the device based on inputs using the web. For example, a web user may use a website to direct content to the mobile device of a friend. The friend may be viewing a broadcast sports event. The content sent using the web may be a clip of an interview involving a player in the game. The friend may switch from the broadcast content to the clip and then back to the broadcast content.

[0369] In an embodiment, content may be ingested in such a manner to facilitate switching between broadcast and unicast/multicast content. Ingestion may be of broadcast content which is provided to a mobile device and/or of unicast/multicast content which is provided to a mobile device. The ingestion process may associate tags with the content to indicate if content is broadcast or unicast/multicast. In embodiments, the tags may assist with switching between content. For example, when a user is watching broadcast content tags associated with the broadcast content may enable the mobile media platform to recommend certain unicast/multicast content based on tags associated with the unicast/multicast content.

[0370] In an embodiment, the broadcast and/or unicast/multicast content may be hosted. In an embodiment, providing broadcast and/or unicast/multicast content to a mobile device may be enabled through hosting. For example, unicast/multicast content may be hosted and/or provided to a mobile device using hosting through a mobile media platform. Hosting may improve the quality of a broadcast and/or unicast/multicast by providing redundancy and buffering.

[0371] In an embodiment, delivery of content may be impacted depending on whether the content is broadcast content and/or unicast/multicast content. A mobile media platform may choose between broadcast and unicast/multicast as the delivery method for a particular item of content. A feed from a content catalog may affect content delivery. In embodiments, a content catalog feed may determine which content is delivered and in certain embodiments may deter-

mine whether to deliver the content using broadcast or unicast/multicast. In an embodiment, delivery of broadcast and/or multicast content may be in the form of a notification, such as an email, text message or instant message, including a link or reference to the content or with the content embedded in the notification itself.

[0372] In embodiments, the ingestion, encoding, transcoding, hosting and delivery of content may be optimized in connection with seamlessly switching between broadcast and unicast content on a mobile device. For example, the network bandwidth for broadcast content and unicast content may be compared and the ingestion, encoding, transcoding, hosting and delivery of content of broadcast and unicast content adjusted so that the user is presented with similar quality for each type of content. In another embodiment, device profiles and device playback capabilities may be taken into account. For example, a device may be able to playback only a reduced quality version of broadcast content, so the broadcast quality is reduced allowing for delivery of correspondingly higher quality unicast content.

[0373] In embodiments, metadata and data may be combined in a single file. The metadata may include information regarding the content of the file including a description of the content and technical aspects regarding the content. This information may be used in connection with delivery of the content and optimization of ingestion, encoding, transcoding, hosting and delivery. The existence of metadata and data in a single file may facilitate the delivery of and switching between broadcast and unicast/multicast content. In an embodiment, the metadata included in a unicast content file may contain information about broadcast content to be associated with this file and a URL associated with the schedules for such broadcast content. Using this information the mobile media platform may recommend to the user a list of related broadcast content currently being or soon to be broadcast. The mobile media platform may contain storage functionality and facilities for storage of broadcast and/or unicast/multicast content and information related to such content.

[0374] In embodiments, the application enabling switching between broadcast and unicast/multicast content may include a user interface. The user interface may contain menus, sliders, icons and items specific to each of broadcast, unicast and multicast content. The user skin or appearance of the user interface may change depending on the broadcast, unicast and multicast nature of the content. While providing broadcast content, the user interface may present links to or recommendations for unicast/multicast content. When providing unicast/multicast content the user interface may present links or recommendations for broadcast content. In embodiments, the links or recommendations may be presented as part of the content itself or in a frame surrounding the content. In an embodiment, the user interface may include an administrative user interface. In an embodiment, the user interface may allow for broadcast and unicast/multicast content to be accessed or displayed simultaneously.

[0375] In embodiments, while displaying or providing access to broadcast content the mobile media platform may provide notifications regarding the broadcast content or associated unicast/multicast content. In embodiments, while displaying or providing access to unicast/multicast content the mobile media platform may provide notifications regarding the unicast/multicast content or associated broadcast content. The notifications may include links to related content or may be notifications of charges incurred. The notifications may be

advertisements for related goods and services. The mobile media platform may provide a notification to a user of the upcoming broadcast of certain content that is recommended based on the users' consumption profile.

[0376] In an embodiment, a mobile media platform may allow searching of both broadcast and unicast/multicast content. Searching may be based on the content, data, metadata, tags and content catalog feed. Search results for associated broadcast and unicast/multicast content may be grouped together. In an embodiment, a search result involving the broadcast of a live concert event may be clustered with search results for unicast music videos and interviews featuring the artists performing at the concert.

[0377] In an embodiment, a mobile media platform may present recommendations. In embodiments, while displaying or providing access to broadcast content the mobile media platform may provide recommendations in connection with the broadcast content, which may include associated unicast/multicast content. In embodiments, while displaying or providing access to unicast/multicast content the mobile media platform may provide recommendations in connection with the unicast/multicast content, which may include associated broadcast content. The recommendations may be generated by a recommendation engine. The recommendations may be based on a consumption profile and/or content catalog feed. The recommendations may be based on content ratings.

[0378] In an embodiment, location information and location intelligence may be used to select the optimal technology for delivery of broadcast and/or unicast/multicast content. In an embodiment location information and location intelligence may be used in connection with content recommendations. In embodiments, location information and location intelligence may be used to enforce black out rules in connection with broadcast content. In an embodiment, using location information and location intelligence, while a user is viewing broadcast content links to unicast/multicast content relating to the location and context of the user may be presented to the user. For example, as a user is watching a broadcast of a program directed at home improvements the user may be provided with a link to a unicast advertisement for a home improvement store in the vicinity of the user.

[0379] In an embodiment, switching between broadcast and unicast/multicast content may be personalized to a particular user. The mobile media platform may include an interactive programming guide. In embodiments, the interactive programming guide may contain both broadcast and unicast/multicast content. The mobile media platform may include a personal entertainment server which may present recommended unicast content and a list of often viewed broadcast channels.

[0380] In embodiments, switching between broadcast and unicast/multicast content may be associated with social networking and social networking aspects of the mobile media platform, including content referral, content rating, gifting, forums, gifting, buddy list management, peer-to-peer management, communities of interest, profile page, dMail, points, message boards, newsletter, shop, home, advertising, notifications, sharing content on mobile devices and the like. In an embodiment, a group of users watching a given broadcast may communicate with each other in a forum associated with that broadcast. In an example, the broadcast may be of a particular sporting event and the forum may be a forum for fans of the home team. In another embodiment, while watching a particular broadcast, a group of users may be able to

share with each other links to unicast/multicast content relating to the broadcast. The related unicast content may be provided as a gift from one user to another user. In embodiments, the group of users may be viewing multicast content instead of broadcast content.

[0381] In embodiments, switching between broadcast and unicast/multicast content may be associated with the e-commerce aspects of the mobile media platform, including Billing, pricing, event tracking, bundling, tiered services, subscriptions, purchasing content, previewing content and the like. In embodiments, switching between broadcast and unicast/multicast content may be associated with the rights management aspects of the mobile media platform, including digital rights management, digital rights administration and computing royalties owes to particular owners of intellectual property.

[0382] In embodiments, switching between broadcast and unicast/multicast content may be associated with the reporting aspects of the platform, including transaction logs, event logs, royalty reports, recommendation reports and the like. In embodiments, reports may be accessed from a web interface. In embodiments, switching between broadcast and unicast/multicast content may be associated with the administrative aspects of the mobile media platform, including account management, preference management, client and/or server management, profiles, registries, and the like. In embodiments, switching between broadcast and unicast/multicast content may be associated with an administrative user interface which may vary by users, administrators, carriers, broadcast content provider, unicast/multicast content provider, and the like.

[0383] In embodiments, switching between broadcast and unicast/multicast content may be associated with providing advertising content. Advertising content may be provided as broadcast and/or unicast/multicast content. Advertising content may be an interstitial advertisement, banner ad, in stream ad, ad placed in the content itself, ad framing the content, an ad appearing before or after other content, and the like. In an embodiment, an advertisement may be interactive and may contain links to other content. In embodiments, advertising content may be targeted on the basis of a consumption profile, data about the user and user preferences, location information and location intelligence and using an ad fulfillment engine.

[0384] In embodiments, switching between broadcast and unicast/multicast content may be associated with the security aspects of the platform, including authentication, authorization, passwords, purchase verification, access control, biometric identification on the mobile device, encryption, access security and the like. In embodiments, switching between broadcast and unicast/multicast content may be associated with the billing aspects of the platform, including collection, pricing, billing, mediation, settlement, reporting and the like. In embodiments, access to broadcast and/or unicast/multicast content may be on a pay per duration and/or subscription model. In embodiments, the billing may be integrated with operator billing systems, carrier billing systems, third party payment processors, broadcasters, unicast/multicast content providers and the like.

[0385] In embodiments, switching between broadcast and unicast/multicast content may be integrated with other systems, including carrier systems, content provider systems, systems of mobile devices, ad servers, Internet-based systems, web-based systems, billing systems, content delivery systems, encoding and transcoding systems, storage systems, social networking systems, hosting systems, ingestion sys-

tems, security systems, search engines, mobile search engines and the like. Integration may be accomplished using hard coding, loose coupling, over a network, using application programming interfaces, using interfaces and the like.

[0386] In embodiments, switching between broadcast and unicast/multicast content may be associated with and supported by the architecture of the platform as described herein. In embodiments, switching between broadcast and unicast/multicast content may be associated with a store front. In an embodiment, the store front may provide access to unicast content while broadcast content is being viewed. In another embodiment, the store front may enable the purchase of broadcast and/or unicast/multicast content.

[0387] In embodiments, switching between broadcast and unicast/multicast content may be associated with various channels of the platform, including distribution channels, wholesale channels, retail channels, mobile operators, web 2.0 sites, device manufacturers, content providers, retailers and the like. In embodiments, switching between broadcast and unicast/multicast content may be associated with games. For example, a unicast game may be provided in connection with broadcast content. In embodiments, switching between broadcast and unicast/multicast content may be associated with various users of the platform, including end users, consumers, advertisers, marketers, content providers, content owners, networks, broadcasters, media companies, mobile carriers, record companies, movie studios, regulators, mobile device designers, mobile device manufacturers, mobile device offerors, mobile service consolidators, affiliates and the like. Types of users may include content providers, content consumers, infrastructure providers, facilitators and the like.

[0388] In embodiments, switching between broadcast and unicast/multicast content may be associated with various business models, including short code and bar code campaigns, white label, private label, subscription, per-use, pre-paid, post-paid, free trial, gifting, begging, distribution initiated on deck, distribution initiated off-deck, distribution initiated via short code, viral distribution, ad-supported models (such as bulk, per view, click-through, search keyword auction, ad media, banner ads, audio/video bumpers, splash screens, interstitials, location based and the like), revenue share management, content provider, mobile operator and the like.

[0389] Referring to FIG. 46, an advanced encoding/transcoding 104 system can be grown to form a complex relationship between content providers 4602 and content consumers 4604 through the use of complex internal interactions between content sources 4608 and encoding facilities 4610.

[0390] Referring to FIG. 47 an embodiment of pre-encoding is provided. An advanced encoding/transcoding 104 facility may create intermediate encodings 4708 by pre-processing 4704 the source content 4702, for example to de-speckle, de-interlace, and convert to MPEG-2 format, which can then be fed into subsequent encoders 4710 to produce tertiary results such as specific encodings 4712 for carriers. Encoding and normalization can thereby occur independently from the device-specific encodings.

[0391] Advanced encoding/transcoding 104 may be associated with automated content tag management 108. A mobile media platform 100 may facilitate an association of advanced encoding/transcoding 104 with automated content tag management 108. A combination of advanced encoding/transcoding 104 with automated content tag management 108 may

facilitate content discovery 144, ingestion 118, encoding, hosting 132, delivery 120, mediation/settlement 112, and user acceptance of mobile content 128 facilitated by the mobile media platform 100.

[0392] Advanced encoding/transcoding 104 may select an encoding method based on mobile device 802 acceptance and/or support of a tagging 108 format associated with an encoding method. Tagging 108 related to the content 128 or metadata associated with the content 128 may influence how advanced encoding/transcoding 104 responds to the tagged content 128. In this way, tagging 108 may facilitate using rules associated with an encoding/transcoding 104 phase of ingestion 118 to setup encoding and delivery.

[0393] Enhanced encoding/transcoding 104 may support tags 108 provided within content 128, such as a camera model number within an image taken by the camera. A flexible tag model associated with a mobile media platform 100 may allow for such use.

[0394] Tags 108 may further support a composite profiling process that may enable transcoding based on information in the tag in addition to other factors related to consumption profile 102 parameters. A content tag may indicate that digital rights restrict the content 128 from being encoded in certain low resolution formats 808. A content tag may indicate that audio portions of the content 128 may preferably be encoded with an encoding method based on the encoding method selected for the visual portion of the content 128. A tag may indicate a portion of the content 128 is dynamic and another portion is nearly static, resulting in advanced encoding/transcoding 104 selecting appropriate encoders for each portion of content 128. In another example, a tag that identifies content 128 encoding format may allow an automatic encoding/transcoding 104 module to self-determine what is being encoded. Without tagging 108, the encoding process may require the content 128 to be examined or a header of the content 128 to be included to determine an encoding format of the content 128.

[0395] Advanced encoding/transcoding 104 may be associated with pause and resume 114 functionality or features. A mobile media platform 100 may facilitate an association of advanced encoding/transcoding 104 with pause and resume 114. A combination of advanced encoding/transcoding 104 with pause and resume 114 may facilitate content discovery 144, ingestion 118, encoding, hosting 132, delivery 120, mediation & settlement 112, and user acceptance of mobile content 128 facilitated by the mobile media platform 100.

[0396] Pause and resume 114, when applied to an encoded stream being delivered to a mobile device 802 may impact advanced encoding/transcoding 104. Pausing delivery may enable encoding output to be redirected to a cache or buffer. Pause and resume 114 functionality that may detect packet by packet mobile content 128 transfers, may be applied to encoding to enable advanced encoding capabilities such as in stream encoding changes.

[0397] Advanced encoding/transcoding 104 may be associated with mediation and settlement 112. A mobile media platform 100 may facilitate an association of advanced encoding/transcoding 104 with mediation and settlement 112. A combination of advanced encoding/transcoding 104 with mediation and settlement 112 may facilitate content discovery 144, ingestion 118, encoding, hosting 132, delivery 120, mediation/settlement 112, and user acceptance of mobile content 128 facilitated by the mobile media platform 100.

[0398] Advanced encoding/transcoding 104 may be associated with content 128, content type, source, and parameters. A mobile media platform 100 may facilitate an association of advanced encoding/transcoding 104 with content 128. A combination of advanced encoding/transcoding 104 with content 128 may facilitate content discovery 144, ingestion 118, encoding, hosting 132, delivery 120, mediation/settlement 112, and user acceptance of mobile content 128 facilitated by the mobile media platform 100.

[0399] Encoding and/or transcoding may be based at least in part on content type. Encoding of audio content 128 may be different than transcoding of video content 128, which may be different than encoding of composite content 128. Live content 128 may require on-demand encoding, whereas stored content 128 may be processed to generate pre-encoded content 128. Sources of content 128 may impact advanced encoding/transcoding 104. User created content 128 may be pre-encoded and available from external hosts in several common formats 808. Alternatively user created content 128 may be irregularly constructed, causing advanced encoding to determine a best fit encoding method based on, for example, trial and error encoding.

[0400] Advanced encoding/transcoding 104 may be associated with web content 130. A mobile media platform 100 may facilitate an association of advanced encoding/transcoding 104 with web content 130. A combination of advanced encoding/transcoding 104 with web content 130 may facilitate content discovery 144, ingestion 118, encoding, hosting 132, delivery 120, mediation/settlement 112, and user acceptance of mobile content 128 facilitated by the mobile media platform 100. Web content 130 may be directly streamable from an Internet server, however web content 130 may have to be transcoded to be accepted by mobile devices 802. Web content 130 that is readily accessible at high bandwidth, may not be pre-encoded but rather may always be encoded on-demand to allow the content 128 source and the encoding to remain independent, yet allow a wide variety of mobile users to access the web content 130.

[0401] Advanced encoding/transcoding 104 may be associated with ingestion 118. A mobile media platform 100 may facilitate an association of advanced encoding/transcoding 104 with ingestion 118. A combination of advanced encoding/transcoding 104 with ingestion 118 may facilitate content discovery 144, ingestion 118, encoding, hosting 132, delivery 120, mediation/settlement 112, and user acceptance of mobile content 128 facilitated by the mobile media platform 100. An advanced encoding/transcoding 104 facility may include ingestion 118 of external content 128. Ingestion and advanced encoding/transcoding 104 may be automatically activated.

[0402] A self-aware ingestion 118 module may be part of the advanced encoding/transcoding 104 facility or it may communicate with the advanced encoding/transcoding 104 facility to deliver content 128 to be managed. Self-aware ingestion 118 may facilitate normalizing content 128 so that content 128 from any type and any format may be normalized, such as through recoding and format conversion, into a format useable by the platform and/or the advanced encoding/transcoding 104 facility. Encoding, recoding, and transcoding may be performed by the self-aware ingestion 118 module. Alternatively, the self-aware ingestion 118 capability may be an attachment to an encoding process of the platform so that ingestion and encoding may be operated under separate constraints. Self-aware ingestion 118 may determine

what encoding, recoding, transcoding, format conversion, filtering, and the like is needed based on ingestion 118 parameters associated with the advanced encoding/transcoding 104 facility and/or the platform. If newly presented content 128 is in an encoding that is not supported, the self-aware ingestion 118 module may order recoding from an attached encoding facility before directing the content 128 to the advanced encoding/transcoding 104 facility. In an example, a self-aware ingestion 118 module may determine that a transcoding process exists to recode newly presented content 128 from its presented encoding to a preferred encoding. In such a situation, the self-aware ingestion 118 module may perform the transcoding to present the content 128 in the preferred encoding.

[0403] Advanced encoding/transcoding 104 may be associated with hosting 132. A mobile media platform 100 may facilitate an association of advanced encoding/transcoding 104 with hosting 132. A combination of advanced encoding/transcoding 104 with hosting may facilitate content discovery 144, ingestion 118, encoding, hosting 132, delivery 120, mediation/settlement 112, and user acceptance of mobile content 128 facilitated by the mobile media platform 100. A mobile media platform 100 may host content 128 that has been encoded or transcoded by an advanced encoding/transcoding 104 facility. The facility may encode raw content 128 into one or more formats 808 for hosting, thereby enabling a host to have fast access to the hosted encoded content 128 for faster delivery when the content 128 is requested by a mobile device 802 that supports the one or more hosted formats 808.

[0404] Advanced encoding/transcoding 104 may be associated with content delivery 120. A mobile media platform 100 may facilitate an association of advanced encoding/transcoding 104 with content delivery 120. A combination of advanced encoding/transcoding 104 with content delivery 120 may facilitate content discovery 144, ingestion 118, encoding, hosting 132, delivery 120, mediation/settlement 112, and user acceptance of mobile content 128 facilitated by the mobile media platform 100. Encoding may be performed on-demand to delivery content 128 as a stream for playback of video, audio, and the like on mobile devices 802. Content 128 may be delivered to a mobile device 802 or distribution 182 portal from a wide variety of content 128 sources and an encoding/transcoding 104 facility may support converting the sourced content 128 as it is sourced so that it can be continuously presented for delivery 120. Mobile devices 802 may provide content 128 to the mobile media platform 100 that the encoding/transcoding 104 facility may recode for delivery 120 to another mobile device 802 or distribution 182 portal. Self-aware encoding/transcoding 104 may be directed toward encoding for a delivery method. Delivery methods such as streaming, download, progressive download, MMS, WAP push, and the like may each impact encoding in different ways. Encoding methods may be combined during a consumption session so that delivery 120 may be separated from encoding method. In an example, live linear content 128 may be encoded on-demand and pre-encoded advertisements may be inserted in the delivery stream.

[0405] Advanced encoding/transcoding 104 may be associated with optimization 134. A mobile media platform 100 may facilitate an association of advanced encoding/transcoding 104 with optimization 134. A combination of advanced encoding/transcoding 104 with optimization 134 may facilitate optimization 134 of content discovery 144, ingestion 118,

encoding, hosting 132, delivery 120, mediation/settlement 120, and user acceptance of mobile content 128 facilitated by the mobile media platform 100. Encoding/transcoding 104 may be employed to generate encoded content 128 that may optimize response time for a request for the content 128 by encoding content 128 into formats 808 that are popular or in demand. A carrier may specify preferred delivery formats 808 during peak network load periods to optimize availability of the network and advanced encoding/transcoding 104 may be used to recode content 128 into the preferred formats 808 (e.g., lower resolution) during peak periods. An encoding format may be determined based on a consumption profile 102 associated with a device 802 or distribution 182 portal requesting or providing content 128 and an advanced encoding/transcoding 104 facility may process content 128 associated with the determined format. Encoding/transcoding 104 may be optimized by an advanced encoding/transcoding 104 facility based on characteristics of the content 128, such as if the content 128 is talking head content 128 that does not change rapidly versus sports content 128 that may change continuously.

[0406] Advanced encoding/transcoding 104 may be associated with combining metadata with creative content 128 in a single file 138. A mobile media platform 100 may facilitate an association of advanced encoding/transcoding 104 with combining metadata with creative content 128 in a single file 138. A combination of advanced encoding/transcoding 104 with combining metadata with creative content 128 in a single file 138 may facilitate content discovery 144, ingestion 118, encoding, hosting 132, delivery 120, mediation/settlement 112, and user acceptance of mobile content 128 facilitated by the mobile media platform 100. Encoding/transcoding 104 may include inserting metadata into a file with encoded creative content 128 so that a receiving device 802 or portal may determine from the metadata information about the encoding, such as encoder version, source encoding format, on-demand versus pre-encoded encoding, and the like.

[0407] Advanced encoding/transcoding 104 may be associated with content storage 122. A mobile media platform 100 may facilitate an association of advanced encoding/transcoding 104 with content storage 122. A combination of advanced encoding/transcoding 104 with content storage 122 may facilitate content discovery 144, ingestion 118, encoding, hosting 132, delivery 120, mediation/settlement 112, and user acceptance of mobile content 128 facilitated by the mobile media platform 100.

[0408] Advanced encoding/transcoding 104 may be associated with a user interface 140. A mobile media platform 100 may facilitate an association of advanced encoding/transcoding 104 with a user interface 140. A combination of advanced encoding/transcoding 104 with a user interface 140 may facilitate content discovery 144, ingestion 118, encoding, hosting 132, delivery 120, mediation/settlement 112, and user acceptance of mobile content 128 facilitated by the mobile media platform 100.

[0409] Advanced encoding/transcoding 104 may be associated with notifications, messages, and alerts. A mobile media platform 100 may facilitate an association of advanced encoding/transcoding 104 with notifications, messages, and alerts 142. A combination of advanced encoding/transcoding 104 with notifications, messages, and alerts 142 may facilitate content discovery 144, ingestion 118, encoding, hosting

132, delivery 120, mediation/settlement 112, and user acceptance of mobile content 128 facilitated by the mobile media platform 100.

[0410] Advanced encoding/transcoding 104 may be associated with content discovery 144. A mobile media platform 100 may facilitate an association of advanced encoding/transcoding 104 with content discovery 144. A combination of advanced encoding/transcoding 104 with content discovery 144 may facilitate content discovery 144, ingestion 118, encoding, hosting 132, delivery 120, mediation/settlement 112, and user acceptance of mobile content 128 facilitated by the mobile media platform 100. Automatic encoding/transcoding 104 of content 128 may be based on content 128 that is discovered, therefore as new content 128 is discovered it may be presented to an advanced encoding/transcoding facility for automated encoding/transcoding 104. A mobile media platform 100 with self-aware encoding/transcoding 104 capability may acquire or detect content 128 in a wide variety of formats 808 and types that may be readily transcoded by the self-aware encoding/transcoding 104 module.

[0411] Advanced encoding/transcoding 104 may be associated with delivery or device 802 location 148. A mobile media platform 100 may facilitate an association of advanced encoding/transcoding 104 with delivery or device 802 location 148. A combination of advanced encoding/transcoding 104 with delivery or device 802 location 148 may facilitate content discovery 144, ingestion 118, encoding, hosting 132, delivery 120, mediation/settlement 112, and user acceptance of mobile content 128 facilitated by the mobile media platform 100. Because mobile device 802 location may dynamically change, an advanced encoding/transcoding 104 facility may react to delivery location changes by adjusting encoding. In an example, as a user moves from a WiFi hot spot to a location serviced only by a standard cellular network, encoding of content 128 being delivered to the device 802 may be switched accordingly. While in the WiFi hot spot, encoding may deliver very high quality encoded content 128 to take advantage of the WiFi bandwidth and may switch to lower resolution encoding to continue to deliver the requested content 128 within the constraints of the network connection that is available to the user device.

[0412] Advanced encoding/transcoding 104 may be associated with personalization 152. A mobile media platform 100 may facilitate an association of advanced encoding/transcoding 104 with personalization 152. A combination of advanced encoding/transcoding 104 with personalization 152 may facilitate content discovery 144, ingestion 118, encoding, hosting 132, delivery 120, mediation/settlement 112, and user acceptance of mobile content 128 facilitated by the mobile media platform 100. An advanced encoding/transcoding 104 facility may react to personalization 152 as determined by, for example, a user profile so that when a user logs onto the platform, the user's preferences relating to encoding may adjust how content 128 is encoded for delivery to the user. When another user logs onto the platform from the same device, different encoding preferences may be applied by the advanced encoding/transcoding 104 facility.

[0413] Advanced encoding/transcoding 104 may be associated with social networking 150. A mobile media platform 100 may facilitate an association of advanced encoding/transcoding 104 with social networking 150. A combination of advanced encoding/transcoding 104 with social networking 150 may facilitate content discovery 144, ingestion 118,

encoding, hosting 132, delivery 120, mediation/settlement 112, and user acceptance of mobile content 128 facilitated by the mobile media platform 100. Social networking may facilitate user to user sharing of content 128, such as by placing the content 128 or a link to the content 128 on a user's social networking site. When a user attempts to share content 128 with another user with a device 802 that does not support the format in which the content 128 being shared is encoded, advanced encoding/transcoding 104 may be employed to recode the content 128 into a format acceptable to the target user device. This encoding/transcoding 104 may be performed automatically as the content 128 is transferred over the network from one user to another without either user being conscious of the transcoding operation.

[0414] Advanced encoding/transcoding 104 may be associated with e-commerce billing 154. A mobile media platform 100 may facilitate an association of advanced encoding/transcoding 104 with e-commerce billing 154. A combination of advanced encoding/transcoding 104 with e-commerce billing 154 may facilitate content discovery 144, ingestion 118, encoding, hosting 132, delivery 120, mediation/settlement 112, and user acceptance of mobile content 128 facilitated by the mobile media platform 100.

[0415] Advanced encoding/transcoding 104 may be associated with rights management 158. A mobile media platform 100 may facilitate an association of advanced encoding/transcoding 104 with rights management 158. A combination of advanced encoding/transcoding 104 with rights management 158 may facilitate content discovery 144, ingestion 118, encoding, hosting 132, delivery 120, mediation/settlement 112, and user acceptance of mobile content 128 facilitated by the mobile media platform 100.

[0416] Advanced encoding/transcoding 104 may be associated with reporting 124. A mobile media platform 100 may facilitate an association of advanced encoding/transcoding 104 with reporting. A combination of advanced encoding/transcoding 104 with reporting may facilitate content discovery 144, ingestion 118, encoding, hosting 132, delivery 120, mediation/settlement 112, and user acceptance of mobile content 128 facilitated by the mobile media platform 100. Reporting may include information about utilization of an encoding/transcoding 104 facility to provide content 128. Encoding/transcoding 104 utilization may be determined based on characteristics of the content 128 delivered, such as live linear streamed content 128 may have utilized on-demand encoding.

[0417] Advanced encoding/transcoding 104 may be associated with platform administration 162. A mobile media platform 100 may facilitate an association of advanced encoding/transcoding 104 with platform administration. A combination of advanced encoding/transcoding 104 with platform administration may facilitate content discovery 144, ingestion 118, encoding, hosting 132, delivery 120, mediation/settlement 112, and user acceptance of mobile content 128 facilitated by the mobile media platform 100.

[0418] Advanced encoding/transcoding 104 may be associated with advertising 164. A mobile media platform 100 may facilitate an association of advanced encoding/transcoding 104 with advertising 164. A combination of advanced encoding/transcoding 104 with advertising 164 may facilitate content discovery 144, ingestion 118, encoding, hosting 132, delivery 120, mediation/settlement 112, and user acceptance of mobile content 128 facilitated by the mobile media platform 100. An advanced encoding/transcoding 104 facility

may interact with an advertising 164 fulfillment engine to encode advertisements into formats 808 that are compatible with content 128 being provided to users so that the content 128 and the advertisements may be seamlessly stitched together during delivery. On-demand encoding/transcoding 104 facilitates real-time advertisement selection and insertion into content 128 being delivered.

[0419] Advanced encoding/transcoding 104 may be associated with security 168. A mobile media platform 100 may facilitate an association of advanced encoding/transcoding 104 with security. A combination of advanced encoding/transcoding 104 with security may facilitate content discovery 144, ingestion 118, encoding, hosting 132, delivery 120, mediation/settlement 112, and user acceptance of mobile content 128 facilitated by the mobile media platform 100.

[0420] Advanced encoding/transcoding 104 may be associated with billing 170. A mobile media platform 100 may facilitate an association of advanced encoding/transcoding 104 with billing. A combination of advanced encoding/transcoding 104 with billing may facilitate content discovery 144, ingestion 118, encoding, hosting 132, delivery 120, mediation/settlement 112, and user acceptance of mobile content 128 facilitated by the mobile media platform 100.

[0421] Advanced encoding/transcoding 104 may be associated with third party integration 172. A mobile media platform 100 may facilitate an association of advanced encoding/transcoding 104 with third party integration 172. A combination of advanced encoding/transcoding 104 with third party integration 172 may facilitate content discovery 144, ingestion 118, encoding, hosting 132, delivery 120, mediation/settlement 112, and user acceptance of mobile content 128 facilitated by the mobile media platform 100. Advanced encoding and/or transcoding may be offered as a service by the platform to third party content 128 management systems. An advanced encoding/transcoding 104 facility may be integrated with a third party content 128 management system to provide encoding transcoding for content 128 managed by the system. In an example, a corporation may employ encoding to exchange content 128 over a private corporate wireless network. To support a wide variety of devices 802 seamlessly on the private wireless network, content 128 may be routed through an advanced encoding/transcoding 104 facility to ensure the content 128 meets the requirements of the destination such as a server, database, executive handheld mobile device, sales person's mobile device, and the like. In another example, a third party may deliver content 128 to the mobile media platform 100 for advanced encoding/transcoding 104, and may receive in reply a Uniform Resource Identifier (URI) that may contain a link to the resulting advanced encoded/transcoded content 128 that may be published and content 128 managed by the mobile media platform 100.

[0422] Advanced encoding/transcoding 104 may be associated with an embodiment of the platform. An embodiment of advanced encoding/transcoding 104 in an embodiment of the platform may provide an architecture 174 that may facilitate content discovery 144, ingestion 118, encoding, hosting 132, delivery 120, mediation/settlement 112, and user acceptance of mobile content 128 facilitated by the mobile media platform 100. Encoding/transcoding 104 may be hardware based, software based, hardware and software based. A particular encoding format may be generated by hardware based on availability of the hardware or by software if the required hardware encoding embodiment is not available. The archi-

ture of an embodiment, and therefore the cost to construct, license, operate, and maintain encoding and/or transcoding on the architecture may be based on the mix of hardware and software dedicated to encoding.

[0423] Referring to FIG. 48, an advanced encoding/transcoding 104 facility may include distributed computing. The advanced encoding/transcoding 104 facility may divide encoding workload between at least two groups of machines: admin servers 4802 that may perform management of encoding work, and worker machines 4804 that may perform encoding. The servers 4802 may manage incoming encoding job requests and delegate the work required to complete the job. The work itself, which may be computationally intensive tasks, such as collecting, encoding especially, and publishing encoded content 4818 may be delivered to a group of processors 4804 that are specifically optimized to handle such tasks. These delegate processors may collectively be known as the 'encoding farm' 4814. Each processor 4804 may generate any one of the required encoded content outputs 4808, 4810, 4812 based on the encoding work delegated.

[0424] The administrative server 4802 workload may be extremely light compared to the workload handled by the encoding farm 4814, which permits relatively few servers 4802 to manage very large numbers of workers 4804. Furthermore, the numbers of servers, workers, and server-worker combinations can be increased arbitrarily, providing practically infinite encoding capacity.

[0425] Advanced encoding/transcoding 104 may be associated with purchasing, shopping, and store-front applications 178. A mobile media platform 100 may facilitate an association of advanced encoding/transcoding 104 with purchasing, shopping, and store-front applications. A combination of advanced encoding/transcoding 104 with purchasing, shopping, and store-front applications may facilitate content discovery 144, ingestion 118, encoding, hosting 132, delivery 120, mediation/settlement 112, and user acceptance of mobile content 128 facilitated by the mobile media platform 100.

[0426] Advanced encoding/transcoding 104 may be associated with distribution 182 channel applications. A mobile media platform 100 may facilitate an association of advanced encoding/transcoding 104 with distribution 182 channel applications. A combination of advanced encoding/transcoding 104 with distribution 182 channel applications may facilitate content discovery 144, ingestion 118, encoding, hosting 132, delivery 120, mediation/settlement 112, and user acceptance of mobile content 128 facilitated by the mobile media platform 100. From an encoding perspective, a distribution 182 channel or portal may be treated similarly to a mobile device 802 in that encoding and transcoding may be based on distribution 182 portal characteristics that may be captured in a distribution 182 portal profile. Encoded content 128 that is provided to a distribution 182 channel may be encoded on-demand or may be pre-encoded.

[0427] Advanced encoding/transcoding 104 may be associated with games 180 and network gaming. A mobile media platform 100 may facilitate an association of advanced encoding/transcoding 104 with games and network gaming. A combination of advanced encoding/transcoding 104 with games and network gaming may facilitate content discovery 144, ingestion 118, encoding, hosting 132, delivery 120, mediation/settlement 112, and user acceptance of mobile content 128 facilitated by the mobile media platform 100. Multi-player network gaming may require exchange of con-

tent 128 among player devices 802. An advanced encoding/transcoding 104 capability may allow devices 802 with incompatible encoding requirements to be used in an on-line gaming session by recoding the content 128 as it is exchanged over a network among the players.

[0428] Advanced encoding/transcoding 104 may be associated with users or participants 184. A mobile media platform 100 may facilitate an association of advanced encoding/transcoding 104 with users or participants. A combination of advanced encoding/transcoding 104 with users or participants may facilitate content discovery 144, ingestion 118, encoding, hosting 132, delivery 120, mediation/settlement 112, and user acceptance of mobile content 128 facilitated by the mobile media platform 100. User preferences, user feedback, and the like may be considered when automatically encoding/transcoding 104 content 128 delivered to or received from a user.

[0429] Advanced encoding/transcoding 104 may be associated with mobile media business models 160. A mobile media platform 100 may facilitate an association of advanced encoding/transcoding 104 with mobile media business models. A combination of advanced encoding/transcoding 104 with mobile media business models may facilitate content discovery 144, ingestion 118, encoding, hosting 132, delivery 120, mediation/settlement 112, and user acceptance of mobile content 128 facilitated by the mobile media platform 100. A business model that targets low cost distribution 182 of content 128 may favor low resolution encoding over high resolution encoding.

[0430] Referring again to FIGS. 9 to 13, automated tagging may be associated with or combined with various other aspects of the mobile media platform.

[0431] Automated content tagging 108 may be associated with the content being distributed, such as audio, video, text, images, photos, applications, games, data, ring tones, wall paper, fonts, hyperlinks, tables, tabular formatted text, user generated content, media, radio, content primitives, composite content, marketing type content, and the like. Tagging 108 may be associated with the characteristics of the content, popularity of the content, length of the content, the individuals or organizations involved in the production of the content, the source of the content, the location of the content, the type of the content, management aspects of the content, technical aspects of the content, user device limitations associated with the content, marketing targets associated with the content, and the like. A mobile media platform may facilitate an association of automated content tagging 108 with content. A combination of automated content tagging 108 with content may facilitate content discovery, ingestion 118, encoding 104, hosting, delivery 104, mediation, settlement, and user acceptance of mobile content facilitated by the mobile media platform.

[0432] In embodiments, tagging 108 may be associated with the characteristics of the content, such as display resolution, image format, language, audio format, and the like. For instance, with a tag 108 associated with the language users and advertisers may select only those content items that are associated with a particular language. Similarly, a tag 108 associated with an image format may allow the user to select only those content items that will play effectively on their device. Tags 108 may indicate the length of the content item in order to allow the user to select only content that is within the timeframe of interest. Tags 108 may be associated with the popularity of a content item, and as such, may allow users to

select from the most popular items, or keep track of how popular an item or show or song is becoming. Advertisers may also use popularity tags **108** to select and cost advertisements to be associated with, or tagged directly into, the content item. Tags **108** may be associated with the individuals associated with the production of the content item, such as the performing artist, the director, the producer, the sponsoring agency, and the like. Tags **108** associated with the performing artist for instance may allow a user to search for work available from the artist, and assemble playlists or collections for that artist. Tags **108** associated with a sponsoring agency may allow the user to select content from say an educational association, a certain publishing house, a government agency, a music label, and the like. Tags **108** may be associated with the source or location of the content, which may allow the user to select local programming, or programming from a specific production group, and the like. Tags **108** may be associated with playback device limitations, such as image resolution, display size, audio quality, speed, and the like. A user may then select only those content items that may allow them to playback content items that run well on their device.

[0433] In embodiments, tagging **108** may improve the quality of experience for a user. For example, a user may want to play some recent TV shows that have become available. Tags **108** associated with the content may allow the user to select the most popular items for that week. In addition, tags **108** may make it possible for the user to download only those content items that will play well on their device, selecting items tagged **108** for the proper display, resolution, link speed, and the like. Subject oriented tags **108** may also allow the user to select topics that are appealing, and alternately, parents may place limitations on the downloads of questionable subject matter. In embodiments, the user may be provided a degree of selection control over content to be viewed through the use of tagged **108** content.

[0434] Automated content tagging **108** may be associated with web content **1004**, such as video **1004A**, music **1004B**, pod casts **1004C**, audio files **1004D**, syndicated shows, POWERPOINT slide shows **1004E**, word processor documents **1004E**, and the like. FIG. 10 depicts one embodiment of a block diagram showing the tagging **108A** of web content **1004** in association with the mobile media platform **100**. Web content **1004** tagging **108** may be associated with the type of media, the date of last revision, the date of collection, the file extension, the URL address of the source, sponsoring agency, display resolution, audio content, trust level of the site, and the like. Web content **1004** tagging **108** may allow the user to search based on the type of media, such as in a user wanting to view pod casts **1004C**. In addition, web content **1004** tags **108** may allow the user to select the general category of all available pod casts **1004C**, a specific pod cast **1004C**, a popular pod cast **1004C**, and the like. The user may also be able to take advantage of time stamp tags **108** associated with web content **1004**, such as when the file was created and when the file was collected by the mobile media platform **100**. Tags **108** may be associated with the file extension for the web content **1004**, such as for a user wanting to search for only POWERPOINT **1004E** slide shows for a certain topic, a word processing document **1004E**, a pdf document **1004E**, and the like. A mobile media platform **100** may facilitate an association of automated content tagging **108** with web content **1004**. A combination of automated content tagging **108** with web content may facilitate content discovery, ingestion **118**,

encoding **104**, hosting, delivery **104**, mediation, settlement, and user acceptance of mobile content facilitated by the mobile media platform **100**.

[0435] In embodiments, the user may also be able to utilize web content **1004** tags **108** to pull up the URL for the web content **1004** item that they've found, so that they might access it at another time, perhaps from a computer with greater capabilities. Web content **1004** tagging **108** may allow for searching based on the sponsoring agency, production group, domain name, and the like, such as looking for web content **1004** from a certain corporation, a college, a broadcasting group, and the like. Web content **1004** tags **108** may specify technical aspects of the web material, such as display resolution, that may affect the effectiveness of how the user views the web content **1004** on their device. Tags **108** may also be available for the media characteristics of the web content **1004**, such as the presence of audio, embedded video, live feeds, and the like. Web content **1004** is also often associated with trustworthiness of the site, that is, is the site trusted for the type of content delivered, the accuracy of the content delivered, as well as whether the site is a trusted source in regard to computer malware.

[0436] Another example of how web content **1004** tags **108** may be utilized, is in association with the news. The Internet may generate a continuous, and large volume of news material, from a great variety of sources. A user may have preferences associated with the news they want to receive. It may be assumed that a user will firstly want to have the latest news, and so time stamped tags **108** may allow for the filtering of news based on time. But the user may also have certain personal preferences for news, such as for certain sources of news, certain types of news, news from specific geographical regions, and the like, and these preferences may be stored in a set of personal profile tags **108** that are associated with an ID, their device, their name, or the like. In addition, their mobile communications device may also have performance related preferences, such as associated with display, link speed, processing speed, and the like, and these preferences may be stored in a set of device profile tags **108**. Together, these tags **108** may help specify which web content **1004** is to be made available to the user, in this instance, for the latest news. In embodiments, web content tags **108** may be able to improve the user applicability of web content **1004**, selected from the vast quantity of available web content **1004**.

[0437] Automated content tagging **108** may be associated with ingestion of content into the mobile media platform for subsequent ingestion **118** and distribution, such as related to the characteristics of the content, the quality of content being ingested, the source of content, the method of ingestion, the trustworthiness of the content, and the like. In embodiments, the ingested content may be tagged **108** for the plurality of content characteristics, such as video properties, audio properties, length of video, quality of video, size of text, file format, and the like. These content tags **108**, assigned at the time of ingestion, may be then stored for subsequent use. In embodiments, these tags **108** may also be used internal to the mobile media platform, such as for ingestion **118** purposes. Quality of content being ingested may be another important attribute to be tagged, such as the quality and reliability of the source, the quality of the data received such as in bit errors, the quality of the data received such as in the resolution level of the images and/or audio, and the like. Quality may be of concern to users, marketing organizations, as well as the content management facility of the mobile media platform,

and as such, may be an important attribute to assign tagging **108** to. The source of the content, not only contributes to the initial assessment of quality of the content, but also may be of interest to the end users, especially if the user is interested in collecting content from a given source, whether considered by the tagging **108** facility as quality or not. A mobile media platform may facilitate an association of automated content tagging **108** with ingestion. A combination of automated content tagging **108** with ingestion may facilitate content discovery, ingestion **118**, encoding **104**, hosting, delivery **104**, mediation, settlement, and user acceptance of mobile content facilitated by the mobile media platform.

[**0438**] In embodiments, it may be of interest to tag **108** and store the method by which the ingested content was acquired, such as in it having been submitted by an individual, acquired by polling a third party, collection by a spider, obtained via an interactive web portal, a Web service API, or the like. Knowing how the material was obtained may help evaluate the quality of the content for tagging **108**, or provide a sense to a user as to its reliability, such as by combining the fact that it had been submitted by an individual, where the individual was left unidentified. As a result, a trustworthiness merit may also be assigned a tag **108**, where trustworthiness may be determined through a specific source of information, such as being from a certified trusted source, or from a combination of acquired information at ingestion that may collectively help determine the trustworthiness rating that may be assigned to content at ingestion.

[**0439**] Automated content tagging **108** may be associated with hosting of content, such as by allowing individuals and organizations to provide their own websites accessible via the Internet Tags **108** associated with hosting may be associated with what servers or clients have access to the hosting, what connectivity is available, what data centers are involved, what processing was associated with the hosting, whether the hosting is a free service or a paid service, whether the hosting is a shared service, whether the host is the primary host, and the like. Tags may be used to publish and un-publish content, date time, or events, catalog listings, and the like. A mobile media platform may facilitate an association of automated content tagging **108** with hosting. A combination of automated content tagging **108** with hosting may facilitate content discovery, ingestion **118**, encoding **104**, hosting, delivery **104**, mediation, settlement, and user acceptance of mobile content facilitated by the mobile media platform.

[**0440**] Automated content tagging **108** may be associated with content delivery **104**, such as the type of delivery **104**, including a file download, a streaming of video, a streaming of video, progressive downloading, and the like; the size of the delivery **104**; combining delivery **104** from multiple sources; availability of refreshes or updates; associated with consumption profiles; source of content; and the like. A mobile media platform may facilitate an association of automated content tagging **108** with content delivery **104**. A combination of automated content tagging **108** with content delivery **104** may facilitate content discovery, ingestion **118**, encoding **104**, hosting, delivery **104**, mediation, settlement, and user acceptance of mobile content facilitated by the mobile media platform.

[**0441**] Automated content tagging **108** may be associated with the optimization of ingestion **118**, encoding **104**, transcoding, hosting, and delivery **104** of content, such as the creation of device profiles, bandwidth adjustments, adjustment of ingestion **118** parameters, associated with device

playback capabilities including independent adjustment of video and audio capabilities, adjustments in association with digital rights management, and the like. A mobile media platform may facilitate an association of automated content tagging **108** with optimization of ingestion **118**, encoding **104**, transcoding, hosting, and delivery **104**.

[**0442**] Automated content tagging **108** may be associated with combining data and metadata in a single file, such as repackaging ingested content, providing packaged content in archive files, combining metadata and multiple versions of the content, type of packaged content (batch ingestion **118**, single ingestion **118**, and real-time ingestion **118**), content wrapped in descriptors, and the like. A mobile media platform may facilitate an association of automated content tagging **108** with combining data and metadata in a single file. A combination of automated content tagging **108** with combining data and metadata in a single file may facilitate content discovery, ingestion **118**, encoding **104**, hosting, delivery **104**, mediation, settlement, and user acceptance of mobile content facilitated by the mobile media platform.

[**0443**] Automated content tagging **108** may be associated with storage, such as storage of content data, including metadata, attributes, parameters; online storage; offline storage; provided on the platform or on the mobile device; provided through a network; provided on different media, including magnetic storage, optical storage, semiconductor storage, and the like. A mobile media platform may facilitate an association of automated content tagging **108** with storage. A combination of automated content tagging **108** with storage may facilitate content discovery, ingestion **118**, encoding **104**, hosting, delivery **104**, mediation, settlement, and user acceptance of mobile content facilitated by the mobile media platform.

[**0444**] Automated content tagging **108** may be associated with a user interface, such as for dynamic rendering, enabling interactivity, viewing thumbnails, facilitating game day tracking, enabling reader features, managing end user presentations, adjusting to device capabilities, skinning, content schedules, daily features, flipbooks, sliders, displaying multiple items at once, split screen applications, framing content with links, and the like. A mobile media platform may facilitate an association of automated content tagging **108** with a user interface. A combination of automated content tagging **108** with a user interface may facilitate content discovery, ingestion **118**, encoding **104**, hosting, delivery **104**, mediation, settlement, and user acceptance of mobile content facilitated by the mobile media platform.

[**0445**] Automated content tagging **108** may be associated with notifications, messages, and alerts, such as management of notifications, notifications for content, notifications for new content, reminders regarding broadcast of certain content, delivery of messages to a user, tracking user notification preferences and generating a message when an event occurs that matches the user preferences, delivery of operator messages, and the like. Tags may be used to publish and un-publish content, date time, or events, catalog listings, and the like. A mobile media platform may facilitate an association of automated content tagging **108** with notifications, messages, and alerts. A combination of automated content tagging **108** with notifications, messages, and alerts may facilitate content discovery, ingestion **118**, encoding **104**, hosting, delivery **104**, mediation, settlement, and user acceptance of mobile content facilitated by the mobile media platform.

[0446] Automated content tagging 108 may be associated with content discovery 144, such as searching, including content, metadata, allowing users to search for categories of content, integration to third party search engines, multiple content store crawls, and the like; recommendations, including recommendation engines, popular clips algorithms, generating recommendations via inferred preferences, based on direct input, based on sensed context, and the like; content catalog feed, including in connection with search and recommendations, mobile search engines, active push feed, passive pull feed, and the like; content management, including managing digital data; deep linking; popular plays; content filtering, content rating, community polling, personalization of content delivery 104, tagging 108 of content, front processing, hierarchical category organization, clip-based retrieval, generalized data modeling, consumption profiles, and the like. FIG. 11 depicts one embodiment of a block diagram showing the tagging in association with content discovery 144 in the mobile media platform 100, where content discovery 144 is an integral part of the content management of the mobile media platform 100, and relates to the end user mobile communication facilities 802 through the distribution facility 182. Tagging 108 may be used to build relationships across content, thereby establishing related content to enhance discovery 144 services. Tags may also be used during discovery 144 to restrict content, by location, based on user preferences such as parental control. A mobile media platform may facilitate an association of automated content tagging 108 with content discovery 144. A combination of automated content tagging 108 with content discovery 144 may facilitate content discovery, ingestion 118, encoding 104, hosting, delivery 104, mediation, settlement, and user acceptance of mobile content facilitated by the mobile media platform 100.

[0447] For example, and in embodiments, a user of a mobile device 802 may have a user profile set up that specifies the content that they want downloaded on a regular basis. In addition, the user profile may specify content that is undesirable, where the user wants to never receive this content. Content discovery 144 may then be governed through this user profile, where as content is tagged at ingestion, the content, as specified in the user profile, is offered for download to the user. In embodiments, may content discovery filters and algorithms may be utilized in facilitating the delivery of desirable content to the user.

[0448] Automated content tagging 108 may be associated with location information and location intelligence, such as relating to the location of a mobile device 802, determined or provided by the mobile device, using a GPS, for locating a device on a network, by examining transactions and selections made using the device, updating location information, identifying business locations near the user, in conjunction with user content, combined with time of day, and the like. FIG. 12 depicts one embodiment of a block diagram showing the tagging of location information and location intelligence in association with the mobile media platform 100, where location information and location intelligence 148 is an integral part of the content management of the mobile media platform 100, and relates to the end user mobile communication facilities 802 through the distribution facility 182. A mobile media platform may facilitate an association of automated content tagging 108 with location information and location intelligence. A combination of automated content tagging 108 with location information and location intelligence may facilitate content discovery, ingestion 118, encod-

ing 104, hosting, delivery 104, mediation, settlement, and user acceptance of mobile content facilitated by the mobile media platform.

[0449] For example, and in embodiments, a user of a mobile device 802 may shoot a video with the device 802, and upload it to the mobile media platform 100 to be made available. The GPS in the mobile device 802 may then supply location information along with the video, and as such, the video may become tagged 108 with location information. Subsequently, a second user in the same vicinity, who wants to download any recent local videos shot by individuals with their mobile devices 802 may now be able to find this new video based on the location tag 108, and download it. In embodiments, groups of local individual in the same local could share videos in near real-time, without actually meeting or knowing one another, say while a sporting event.

[0450] Automated content tagging 108 may be associated with personalization of user experience, such as personal entertainment, an interactive programming guide, recommendations from communities, serving content regularly watched by the user, and the like. Tags may also be used during discovery to restrict content, by location, based on user preferences such as parental control. A mobile media platform may facilitate an association of automated content tagging 108 with personalization of user experience. A combination of automated content tagging 108 with personalization of user experience may facilitate content discovery, ingestion 118, encoding 104, hosting, delivery 104, mediation, settlement, and user acceptance of mobile content facilitated by the mobile media platform.

[0451] Automated content tagging 108 may be associated with social networking, such as user content referring, user content rating, forums, gifting, buddy list management, peer-to-peer management, communities of interest, profile pages, points, message boards, newsletters, shops, homepage changes, advertising, notifications, sharing content on mobile devices, and the like. A mobile media platform may facilitate an association of automated content tagging 108 with social networking. A combination of automated content tagging 108 with social networking may facilitate content discovery, ingestion 118, encoding 104, hosting, delivery 104, mediation, settlement, and user acceptance of mobile content facilitated by the mobile media platform.

[0452] Automated content tagging 108 may be associated with e-commerce and e-billing, such as billing, pricing, event tracking, bundling, tiered services, purchasing individual items, previewing, demos, discounts, delivery and monetization of multimedia advertising messages, and the like. A mobile media platform may facilitate an association of automated content tagging 108 with e-commerce and e-billing. A combination of automated content tagging 108 with e-commerce and e-billing may facilitate content discovery, ingestion 118, encoding 104, hosting, delivery 104, mediation, settlement, and user acceptance of mobile content facilitated by the mobile media platform.

[0453] Automated content tagging 108 may be associated with rights management, such as digital rights management, providing administration rights in a digital environment, allowing the rights holders to be compensated for the use of their intellectual property, adapting to specific implementation of digital rights management with the carrier, and the like. A mobile media platform may facilitate an association of automated content tagging 108 with rights management. A combination of automated content tagging 108 with rights

management may facilitate content discovery, ingestion **118**, encoding **104**, hosting, delivery **104**, mediation, settlement, and user acceptance of mobile content facilitated by the mobile media platform.

[0454] Automated content tagging **108** may be associated with reporting, such as with a transaction log, an event log, reports used to compute royalties, reports used for recommendations, generating and access reports from a web interface, and the like. A mobile media platform may facilitate an association of automated content tagging **108** with reporting. A combination of automated content tagging **108** with reporting may facilitate content discovery, ingestion **118**, encoding **104**, hosting, delivery **104**, mediation, settlement, and user acceptance of mobile content facilitated by the mobile media platform.

[0455] Automated content tagging **108** may be associated with administration, including an administration user interface, managing users, managing accounts, managing preferences, client side management, storefront, user profiles, user registry, carrier profiles, user interface, administrative interface for content management, and the like. A mobile media platform may facilitate an association of automated content tagging **108** with administration. A combination of automated content tagging **108** with administration may facilitate content discovery, ingestion **118**, encoding **104**, hosting, delivery **104**, mediation, settlement, and user acceptance of mobile content facilitated by the mobile media platform.

[0456] Automated content tagging **108** may be associated with advertising, marketing, advertisement management, and ad fulfillment engine, such as content that may be advertisements/marketing materials, advertisements inserted into other content, advertisements associated with one or more related or companion advertisements, an advertisement associated with one or more prohibited advertisements, advertisements that are automatically triggered, advertisements ingested similar to other content, advertising management, targeted advertising, ad fulfillment of objectives via an ad fulfillment engine, and the like. FIG. 13 depicts one embodiment of a block diagram showing the tagging of advertisement, marketing, advertisement management, and ad fulfillment engine in association with the mobile media platform **100**, where the advertisement facility **164** is an integral part of the content management of the mobile media platform **100**, and relates to the end user mobile communication facilities **802** through the distribution facility **182**, and to sponsors **1302** external to the mobile media platform **100**. A mobile media platform may facilitate an association of automated content tagging **108** with advertisement, marketing, advertisement management, and ad fulfillment engine. A combination of automated content tagging **108** with advertisement, marketing, advertisement management, and ad fulfillment engine may facilitate content discovery, ingestion **118**, encoding **104**, hosting, delivery **104**, mediation, settlement, and user acceptance of mobile content facilitated by the mobile media platform.

[0457] For example, and in embodiments, a sponsor **1302** of sports apparel may want to associate the recent popular downloads associated with last weekend's NFL football games. The sponsor **1302** may search for tags **108** associated with football from last weekend, and add their own tag **108** that associates their advertisement with the football content. In addition, the content management facility **902** may continue to tag **108** football content upon ingestion **118** from last

weekend to the sponsor's **1302** advertisement, based on some prearrangement between the sponsors **1302** and the content management facility **902**.

[0458] Automated content tagging **108** may be associated with security, such as authentication, authorization, passwords, purchase verification, access control, biometric identification on the mobile device, encryption, access security, security directed at protecting the content, transfers of content, and the like. A mobile media platform may facilitate an association of automated content tagging **108** with security. A combination of automated content tagging **108** with security may facilitate content discovery, ingestion **118**, encoding **104**, hosting, delivery **104**, mediation, settlement, and user acceptance of mobile content facilitated by the mobile media platform.

[0459] Automated content tagging **108** may be associated with billing, such as usage collection, pricing, operator billing, off-portal billing, loyalty programs, loyalty programs, integration with operator billing systems, integration with third party payment processors, carrier BSS and/or OSS, use of percentage of billing event methodology, data charge based on the amount of bandwidth consumed by delivery, and the like. A mobile media platform may facilitate an association of automated content tagging **108** with billing. A combination of automated content tagging **108** with billing may facilitate content discovery, ingestion **118**, encoding **104**, hosting, delivery **104**, mediation, settlement, and user acceptance of mobile content facilitated by the mobile media platform.

[0460] Automated content tagging **108** may be associated with integration with other systems, such as carrier systems, content provider systems, systems of mobile devices, ad servers, Internet-based systems, web-based systems, billing systems, content delivery systems, ingestion **118** and transcoding systems, storage systems, social networking systems, hosting systems, ingestion **118** systems, security systems, search engines, mobile search engines and the like. Methods of integration may include hard coding, loose coupling, over a network, using application programming interfaces, using interfaces and the like. A mobile media platform may facilitate an association of automated content tagging **108** with integration with other systems. A combination of automated content tagging **108** with integration with other systems may facilitate content discovery, ingestion **118**, encoding **104**, hosting, delivery **104**, mediation, settlement, and user acceptance of mobile content facilitated by the mobile media platform.

[0461] Automated content tagging **108** may be associated with architecture of the platform, such as an application layer, a business module layer, a component layer, a system layer, a thin client or rich client layer, a device registry, and the like. A mobile media platform may facilitate an association of automated content tagging **108** with architecture of the platform. A combination of automated content tagging **108** with architecture of the platform may facilitate content discovery, ingestion **118**, encoding **104**, hosting, delivery **104**, mediation, settlement, and user acceptance of mobile content facilitated by the mobile media platform.

[0462] Automated content tagging **108** may be associated with purchasing, shopping, and store front applications, such as facility to market content to consumers via a number of channels, including interactive WAP, web, and mobile rich client applications, as well as SMS short code, mobile bar code campaigns, enabling customers to discover content, provide a means for content providers to highlight and display

the valuable content the user via product placement in the user interface, most popular feature rotations, grouping of associated content into themes, purchasing platform, home shopping network, and the like. A mobile media platform may facilitate an association of automated content tagging 108 with purchasing, shopping, and store front applications. A combination of automated content tagging 108 with purchasing, shopping, and store front applications may facilitate content discovery, ingestion 118, encoding 104, hosting, delivery 104, mediation, settlement, and user acceptance of mobile content facilitated by the mobile media platform.

[0463] Automated content tagging 108 may be associated with distribution and channel applications, such as portals, content portals, distribution channels, digital distribution, retail channels, wholesale channels, and the like. A mobile media platform may facilitate an association of automated content tagging 108 with distribution and channel applications. A combination of automated content tagging 108 with distribution and channel applications may facilitate content discovery, ingestion 118, encoding 104, hosting, delivery 104, mediation, settlement, and user acceptance of mobile content facilitated by the mobile media platform.

[0464] Automated content tagging 108 may be associated with games, such as including, enabling games, facilitating games; creation of gaming portals, games over a network, single player games, multiplayer games, virtual world environments, the ability to have tournaments and share scores, and the like. A mobile media platform may facilitate an association of automated content tagging 108 with games. A combination of automated content tagging 108 with games may facilitate content discovery, ingestion 118, encoding 104, hosting, delivery 104, mediation, settlement, and user acceptance of mobile content facilitated by the mobile media platform.

[0465] Automated content tagging 108 may be associated with users of the platform, such as end users, consumers, advertisers, marketers, content providers, content owners, networks, broadcasters, media companies, mobile carriers, record companies, movie studios, regulators, mobile device designers, mobile device manufacturers, mobile device offerors, mobile service consolidators, affiliates, and the like. A mobile media platform may facilitate an association of automated content tagging 108 with users of the platform. A combination of automated content tagging 108 with users of the platform may facilitate content discovery, ingestion 118, encoding 104, hosting, delivery 104, mediation, settlement, and user acceptance of mobile content facilitated by the mobile media platform. Tags may also be used during discovery to restrict content, by location, based on user preferences such as parental control.

[0466] Automated content tagging 108 may be associated with business models on the platform, such as shared risk models, shared reward models, short code and bar code campaigns, white label/private label, payment and pricing models, distribution, ad-supported models, revenue share management, and the like. A mobile media platform may facilitate an association of automated content tagging 108 with business models on the platform. A combination of automated content tagging 108 with business models on the platform may facilitate content discovery, ingestion 118, encoding 104, hosting, delivery 104, mediation, settlement, and user acceptance of mobile content facilitated by the mobile media platform.

[0467] Referring to FIG. 14, in an embodiment, a pause and resume 114 functionality may be associated with Web content 130, such as content 130 originating on the World Wide Web or the Internet. Any of the types, sources and examples of content 128 discussed herein may be web content 130. For example and without limitation, a user viewing streaming amateur video on their mobile device 1414 may pause playback with a pause functionality in order to begin live streaming of a television show. When the television show concludes or at any point during its progress, the user may choose to resume playback of the streaming video using a resume functionality. In another example, a user using a mobile device 1414 may set a preference that all content 128 should be automatically paused when a call comes into the mobile device 1414. For example and without limitation, if a user is playing an online game, when a call is received, the online game may automatically pause. Content 128 may be automatically resumed if the user ignores the phone call, such as by depressing an ignore key, or may resume upon user request. In another example, a user may pause video playback from a WAP site by closing the device clamshell or automatically detecting an incoming phone call or other intervention.

[0468] In an embodiment, a pause and resume 114 functionality of a mobile media platform 100 may be associated with hosting. For example, hosting may involve making paused content 128 available or receiving paused content 128 over a network. In an embodiment, hosting may involve making paused content 128 available to or receiving paused content 128 from a mobile device 1414. In another example, content that may be paused indefinitely may be hosted by a mobile media platform 100 as opposed to the content source.

[0469] In an embodiment, a pause and resume 114 functionality of a mobile media platform 100 may be associated with delivery of content and paused content to a mobile device 1414, as described herein. In an embodiment, the pause and resume 114 functionality may be delivery mechanism agnostic. That is, controlling content via a pause and resume 114 functionality may be similar if content is delivered via download, streaming, or any of the delivery mechanisms described herein. In an embodiment, the pause and resume 114 functionality may enable combining the delivery of content 128 from different sources or via different means. For example, a user watching a mobile broadcast of a sporting event may be provided a link to view a pre-recorded video clip that covers the highlights of the game to that point. Clicking the link may automatically pause the broadcast and result in the application switching video delivery sources from the mobile broadcast network to the cellular network and causing the highlighted video clip to be streamed on-demand to the user via the cellular network. After viewing the clip, the users could be provided other links to allow them to choose from a list of other content 128 that is available on either the broadcast or cellular networks, or they may choose to resume the previous broadcast.

[0470] In an embodiment, a pause and resume 114 functionality of a mobile media platform 100 may be associated with optimization of various processes, capabilities, and features of the mobile media platform 100, such as ingestion, encoding, hosting, delivery, and the like. For example, optimization may be enacted for generating ideal pause points for advertising insertions, such as by aggregating most frequently paused points for all users.

[0471] In an embodiment, a pause and resume 114 functionality of a mobile media platform 100 may be associated with packaging content 128 including repackaging ingested content 128.

[0472] In an embodiment, a pause and resume 114 functionality of a mobile media platform 100 may be associated with storage and at least one storage facility. For example, the pause and resume 114 functionality may be used to control content that is in storage.

[0473] In an embodiment, a pause and resume 114 functionality of a mobile media platform 100 may be associated with a user interface 140 for enabling interactivity, viewing thumbnails, facilitating game day tracking, enabling rich new reader features, managing end user presentation, and the like. For example, the user interface 140 may be used to access controls associated with the pause and resume 114 functionality. Referring now to FIG. 49, a user interface of a mobile device may be useful for presenting pause and resume controls. For example, device 4914 may have a set of keys that become active when a user requests playback such as on a touchscreen of the device 1414 or where an assigned key becomes activated for a particular function. In the example, playback controls include at least one of play 4904, stop 4908, rewind 4902, fast forward 4910, and the like. In an embodiment, the pause functionality, such as shown in 4912 of device 4918, may not be active until play has been initiated or may always be present. In an embodiment, a pause and resume 114 functionality may be associated with a reporting user interface, a content management user interface, an administration user interface, an ingestion management user interface, and the like.

[0474] In an embodiment, a pause and resume 114 functionality of a mobile media platform 100 may be associated with notification and delivery of messages to mobile device 1414 users. For example, if an urgent notification or message is sent to the device, any content being played on the device may automatically pause to view the notification or message. The user may choose to resume playback after having viewed the notification or message. In an embodiment, a user may manually pause content to check for or view notifications and messages.

[0475] In an embodiment, a pause and resume 114 functionality of a mobile media platform 100 may be associated with content discovery 144. For example and without limitation, during playback of a foreign movie, a user may wish to find related content or may need to access a source to help in interpreting the movie. The user may pause the movie and access content discovery 144 tools. Once the user is ready to resume the movie, they may use a resume functionality. In another example, a user may pause current playback when a content discovery 144 feed notifies the user of new content. Once the user consults the feed, they may choose to resume the playback or take another action, such as select new content from the feed.

[0476] In an embodiment, a pause and resume 114 functionality of a mobile media platform 100 may be associated with a personalized user experience. The pause and resume 114 functionality may enable a mobile device 1414 to navigate a personal entertainment portal to a personal entertainment server or vice-versa.

[0477] In an embodiment, a pause and resume 114 functionality of a mobile media platform 100 may be associated with social networking or community aspects. For example, a user may pause content to refer content, rate content, gift

content, receive friends' ratings, visit a forum associated with the content, to receive a message from a friend, share the content with a peer, and the like.

[0478] In an embodiment, a pause and resume 114 functionality of a mobile media platform 100 may be associated with e-commerce such as billing, pricing, event tracking, bundling, tiered services, content 128 purchase (e.g. individual pieces, collections, subscriptions), discounts, free services and content 128, multimedia advertising delivery and monetization. For example, content may be automatically paused in order to engage a user in e-commerce, such as to pay for the remaining duration of content.

[0479] In an embodiment, a pause and resume 114 functionality of a mobile media platform 100 may be associated with digital rights management. For example, certain functionalities may be disabled due to digital rights management, such as pause, resume, or both.

[0480] In an embodiment, a pause and resume 114 functionality of a mobile media platform 100 may be associated with reporting facilities, such as transaction logs, event logs, digital rights and virtual property use and consumption royalties and recommendation reporting. For example, an event log may record content played, the number of times it was played, the number of pauses, the actual time the content was accessed based on playback time and paused time, and the like. Reports may be generated and/or accessed through a web interface.

[0481] In an embodiment, a pause and resume 114 functionality of a mobile media platform 100 may be associated with mobile media platform 100 related administration. For example, an administration user interface may be used to set preferences for a pause and resume 114 functionality. In a certain embodiment, the pause and resume 114 functionality may be associated with a user interface 140 for ingestion management, including administrative aspects of ingestion management. For example, the user interface 140 may allow a user to pause ingestion.

[0482] In an embodiment, a pause and resume 114 functionality of a mobile media platform 100 may be associated with advertising content. Content 128 may be advertisements, marketing materials and the like. The content 128 may be an interstitial advertisement, banner ad, in stream ad, ad placed in the content 128 itself, ad framing the content 128, an ad appearing before or after the content 128 and the like. A pause and resume 114 functionality may facilitate ad insertion at any point during the content without having to make the advertisement part of the content itself.

[0483] In an embodiment, a pause and resume 114 functionality of a mobile media platform 100 may be associated with a security facility and security functionality, which may include authentication, authorization, passwords, purchase verification, access control, biometric identification, encryption and the like. For example, to resume playback of content, a user may be required provide authorization.

[0484] In an embodiment, a pause and resume 114 functionality of a mobile media platform 100 may be associated with a variety of billing systems. For example, billing may be based on the amount of bandwidth consumed by the delivery of a piece or collection of content 128, which may be less than 100% if content was paused and never resumed.

[0485] In an embodiment, a pause and resume 114 functionality of a mobile media platform 100 may be associated or integrated with other systems by various methods of integration. Other systems may include carrier systems, content

provider 1424 systems, systems of mobile devices 1414, ad servers, Internet-based systems, web-based systems, billing systems, content 128 delivery systems, encoding and transcoding systems, storage systems, social networking systems, hosting systems, ingestion systems, security systems, search engines, mobile search engines and the like. Methods of integration may include hard coding, loose coupling, over a network, using application programming interfaces, using interfaces and the like.

[0486] In an embodiment, a pause and resume 114 functionality may be associated with general architecture aspects of the mobile media platform 100 which are disclosed through this specification and may include, without limitation, any of the following: application layer (J2ME, BREW, WAP, HTML, etc), a business module including a content 128 facility layer for fulfillment and hosting, a commerce facility layer for merchandising and billing, a culture facility layer for communities and personalization, a component layer with modules and/or facilities that include search interface, digital rights management, loyalty programs, partner management, a registry of the parties involved in the creation and delivery of content 128, and the revenue sharing relationship between the parties. For example, the pause and resume functionality may be deployed by any layer or element of the general architecture to enable pause and resume of content in association with any element of the general architecture.

[0487] In an embodiment, a pause and resume 114 functionality may be associated with a store front application of the mobile media platform 100 which may include a facility to market content 128 to consumers via a number of channels, including interactive WAP, web, and mobile rich client applications, as well as SMS short code, and mobile bar code campaigns. For example, a user may pause content playback to access the store front application to discover content 128.

[0488] In an embodiment, a pause and resume 114 functionality of a mobile media platform 100 may be associated with its role as a portal, content 128 portal or the like.

[0489] In an embodiment, a pause and resume 114 functionality of a mobile media platform 100 may be associated with games, such as mobile games. For example, a user playing a game on a mobile device 1414 may be able to pause and the resume game play.

[0490] In an embodiment, a pause and resume 114 functionality of a mobile media platform 100 may be associated with a wide variety of users who may interact with, benefit from, or otherwise have a relationship to the mobile media platform 100 or to the pause and resume 114 functionality aspect of the mobile media platform 100. Representative users may include end users; consumers, advertisers, marketers, content provider 1424, content 128 owners, networks, broadcasters, media companies, mobile carriers, record companies, movie studios, regulators, mobile device 1414 designers, mobile device 1414 manufacturers, mobile device 1414 offerors, mobile service consolidators and affiliates, and the like. In an embodiment, any user may have access to, control, set preferences for, deactivate, or activate pause and resume functionality associated with any content.

[0491] In an embodiment, a pause and resume 114 functionality of a mobile media platform 100 may be associated with various business models.

[0492] Continuing to refer to FIGS. 16 and 17, in an embodiment, mediation and settlement 112 may be associated with various types of content 128 that may be sourced from a variety of sources. Types of content 128 may include

audio, video, text, images, photos, applications, games, data, ring tones, wall paper, fonts, hyperlinks, tables, tabular formatted text, user generated content 128, media, content 128 primitives, composite content 128, marketing type content 128, and the like, and new content 128 types that may continue to be invented and adapted over time that the mobile media platform 100 may extend to cover. The media data record 1692 may normalize data associated with any content type.

[0493] In an embodiment, mediation and settlement 112 may be associated with web content 128, such as content 128 originating on the World Wide Web or the Internet. The media data record 1692 may normalize data associated with any web content.

[0494] In an embodiment, mediation and settlement 112 may be associated with a content ingestion 118 functionality and capability that may be associated with a consumption profile, content 128 management, and the like. Mediation and settlement 112 may cull data from content ingestion 118 to include in a media data record 1692.

[0495] In an embodiment, mediation and settlement 112 may be associated with a hosting 132 capability of a mobile media platform 100. For example, hosting may involve making content 128 available or receiving content 128. The act of making content 128 available may automatically initiate a media data record 1692 capture and tracking of the content to facilitate eventual mediation and settlement 112.

[0496] In an embodiment, mediation and settlement 112 may be associated with content delivery 120 to mobile devices 1614. Content 128 that is delivered may be personalized using similar genres, teams, communities of interest, and other content 128 based mechanisms, and such personalization may be tracked as potential revenue allocation items. Monitoring the method of content delivery 120 may also be associated with mediation and settlement 112 as certain methods of delivery may generate more revenue than others. The media data record 1692 may capture information such as whether content delivery 120 includes delivery of content 128 from different sources or via different means.

[0497] In an embodiment, mediation and settlement 112 may be associated with optimization 134 associated with various processes, capabilities, and features of the mobile media platform 100. Optimization 134 may be enacted for ingestion 118, encoding, transcoding, hosting, delivery, and the like. Optimization 134 may facilitate the capture of information for the media data record 1692. For example, as an optimization 134 is made to the delivery of content, the media data record 1692 may be triggered to track and record the media data event.

[0498] In an embodiment, mediation and settlement 112 may be associated with packaging content 128 including repackaging ingested content 128. The media data record 1692 may keep track of the parameters of the packaged or repackaged content.

[0499] In an embodiment, mediation and settlement 112 may be associated with storage 122 and at least one storage facility. In an embodiment, storage 122 may be a media data event that may be tracked on the media data record 1692.

[0500] In an embodiment, mediation and settlement 112 may be associated with a user interface 140 for enabling interactivity, viewing thumbnails, facilitating game day tracking, enabling rich new reader features, managing end user presentation, and the like. The user interface 140 may also be used to access and update a media data record 1692

and participate in mediation and settlement 112. For example and without limitation, when a user interface 140 may be used to activate a UI widget, tracking may commence in the media data record 1692. In an embodiment, the user interface 140 may be used to administer mediation and settlement 1692 and the parameters associated with generating the media data record 1692.

[0501] In an embodiment, mediation and settlement 112 may be associated with notification and delivery of messages 142 to mobile device 1614 users. The mobile media platform 100 may support user directed management of notifications 142 so that the user may determine how and when notifications, alerts, and messages 142 are delivered. A notification, alert, or message 142 may be related to mediation and settlement 112, such as to inform a user that certain activities may be tracked for the purposes of content distribution revenue allocation.

[0502] In an embodiment, mediation and settlement 112 may be associated with content discovery 144. For example, content discovery 144 may be enabled by a paid search or third party content database. Such paid search or database mining activity may be captured by a media data record 1692 for mediation and settlement 112.

[0503] In an embodiment, mediation and settlement 112 of a mobile media platform 100 may be associated with information relating to the location 148 of a mobile device 1614 or user and/or intelligence derived in whole or in part from such location information 148. For example, a media data record 1692 may include a record of content 1620 a user may access based on a location.

[0504] In an embodiment, mediation and settlement 112 of a mobile media platform 100 may be associated with a personalized user experience 152. In embodiments the platform may leverage recommendations from the communities to which the user belongs and use the information to present relevant content 128. A media data record 1692 may track such recommendations and content 128 views associated with such requests.

[0505] In an embodiment, mediation and settlement 112 may be associated with social networking 150 or community aspects. Social networking 150 aspects may include user content 128 referral, user content 128 rating, forums, gifting, buddy list management, peer-to-peer management, communities of interest, profile pages, dMail, points, message boards, newsletters, shopping, dynamic home page construction, advertising, notifications, and the like. For example, a media data record 1692 may track content 128 distributed amongst a group of peers or posted on a social networking homepage for mediation and settlement 112.

[0506] In an embodiment, mediation and settlement 112 may be associated with carrier 1682 management. Mediation and settlement 112 may be associated with ecommerce 154 such as billing, pricing, event tracking, bundling, tiered services, content 128 purchase (e.g. individual pieces, collections, subscriptions), discounts, free services and content 128, multimedia advertising delivery and monetization. In an embodiment, a subscription may be to certain content 128 and certain additional content 128 is identified as premium content 128 outside the subscription plan and the user has to pay extra to access this content 128. A media data record 1692 may track such access to content 128 and associate it with a subscription or being outside of a subscription plan.

[0507] In an embodiment, mediation and settlement 112 may be associated with digital rights management 158. A

media data record 1692 may allow rights holders to track and receive compensation for use of their content 128 and other intellectual property. The mobile media platform 100 may adapt the implementation of digital rights management 158 to different carriers 1682.

[0508] In an embodiment, mediation and settlement 112 may also provide reporting 124 facilities, such as transaction logs, event logs, digital rights and virtual property use and consumption royalties and recommendation reporting 124. Reports may be generated and/or accessed through a web interface based on information contained in a media data record 1692.

[0509] In an embodiment, mediation and settlement 112 may be associated with mobile media platform 100 related administration 162. An administration user interface 162 may be accessed to set preferences for capture of data in a media data record 1692, to view data captured in a media data record 1692, to reconcile data captured in a media data record 1692, and the like.

[0510] In an embodiment, mediation and settlement 112 may be associated with advertisements 164, marketing materials and the like. Advertising content may be tracked in a media data record 1692 to determine an appropriate share of revenue due or payment required from an advertiser. In an embodiment, the media data record 1692 may record click-throughs, or whether a user interacted with an advertisement or eventually purchased an item or service advertised. In an embodiment, the media data record 1692 may be associated with an ad fulfillment engine to enable generation of reports regarding the delivery and consumption of advertisements 164 and other content 128. The ad fulfillment engine may interface with, assist or be assisted by the settlement and mediation processes of the mobile media platform 100.

[0511] In an embodiment, mediation and settlement 112 may be associated with a security facility 168 and security functionality, which may include authentication, authorization, passwords, purchase verification, access control, biometric identification, encryption and the like. Security 168 may be directed at securing access to the platform and may also be directed at protecting the content 128 and information of the platform, such as during data transfers. Mediation and settlement 112 may account for various security measures, for example, where the platform 100 operator charges a larger fee for more rigorous security measures. A media data record 1692 may contain data on a security aspect of accessed content 128.

[0512] In an embodiment, mediation and settlement 112 may be associated with a variety of billing systems 170. Usage collection may provide a mechanism to collect relevant information related to the consumption of content 128 and store it in a central location for billing 170 and reporting purposes. A media data record 1692 may contain such usage information to facilitate billing 170 and reporting.

[0513] In an embodiment, mediation and settlement 112 may be integrated with other systems by various methods of integration 172. Other systems may include carrier 1682 systems, content provider systems, systems of mobile devices 1614, ad servers, Internet-based systems, web-based systems, billing systems, content delivery 120 systems, encoding and transcoding systems, storage 122 systems, social networking systems, hosting systems, ingestion systems, security systems, search engines, mobile search engines and the like. Methods of integration 172 may include hard coding, loose

coupling, over a network, using application programming interfaces, using interfaces and the like.

[0514] In an embodiment, mediation and settlement 112 may be associated with general architecture 174 aspects of the mobile media platform 100 which are disclosed through this specification and may include, without limitation, any of the following: application layer (J2ME, BREW, WAP, HTML, etc), a business module including a content 128 facility layer for fulfillment and hosting, a commerce facility layer for merchandising and billing, a culture facility layer for communities and personalization, a component layer with modules and/or facilities that include search interface, digital rights management, loyalty programs, partner management, a registry of the parties involved in the creation and delivery of content 128, and the revenue sharing relationship between the parties. A media data record 1692 may be useful for determining revenue shares and revenue reconciliation between the various entities, peer-to-peer management, buddy list management, browser interface, streaming service, off-portal billing, customer service representatives, self-care management, content 128 filter management, gifting, encoding, transcoding, download service, operator billing, advertisement manager, notification management, forum/blog/rant, content ingestion 118, device management, pricing, management console, profile management, user content 128 rating, content 128 management, delivery management, usage collection, storefront, user registry, user content 128 referral, and the like.

[0515] In an embodiment, mediation and settlement 112 may be associated with a store front application 178 which may include a facility to market content 128 to consumers via a number of channels, including interactive WAP, web, and mobile rich client applications, as well as SMS short code, and mobile bar code campaigns. The store front application 178 may enable consumers to discover content 128, provide a means for content providers to highlight and display the valuable content 128 to the user via product placement in the user interface through 'most popular' feature rotation and content 128 grouping based on themes and providing interactive cues (e.g. "more like this"). Usage of the store front application may be tracked in a media data record 1692.

[0516] In an embodiment, mediation and settlement 112 may be associated with the mobile media platform's 100 role as a portal 182, content portal or the like. The platform may include or function as a distribution channel, such as a content 128 distribution channel, digital distribution or the like. Mediation and settlement 112 may facilitate reconciling revenue share and costs associated with this role.

[0517] In an embodiment, mediation and settlement 112 may be associated with games 180, such as mobile games. A media data record 1692 may track access to games 180 and gaming activities.

[0518] In an embodiment, mediation and settlement 112 may be associated with a wide variety of users 184 who may interact with, benefit from, or otherwise have a relationship to the mobile media platform 100 or to aspects of the mobile media platform 100. Representative users may include end users; consumers, advertisers 1684, marketers, content providers, content owners, networks, broadcasters, media companies, mobile carriers 1682, record companies, movie studios, regulators, mobile device designers, mobile device manufacturers, mobile device offerors, mobile service consolidators and affiliates, and the like.

[0519] In an embodiment, mediation and settlement 112 may be associated with various business models 160. Business models 160 may include models for operating the mobile media platform 100, providing services associated with the platform, establishing business relationships with partners, capitalizing on market opportunities, protecting and promoting platform related intellectual property, internationalization, and the like. Mediation and settlement 112 may enable various business models 160 by establishing revenue sharing management and cost sharing management.

[0520] Content types, sources and parameters may be combined with social networking that may include content referral, rating, gifting, forums, profiles, and lists and may also be associated with a mobile media platform. This combination may be further combined with a consumption profile which may include a device profile, a user profile, a network profile, an encoding profile, and the like. The combination of content types with social networking as herein described may further be combined with one or more of unicast/multicast/broadcast seamless switching, advanced encoding and/or transcoding, automated content tagging, content pause and resume, and mediation and settlement.

[0521] Web content may be combined with optimization of ingestion, encoding, transcoding, hosting, and/or delivery that may be associated with a mobile media platform. This combination may be further combined with a consumption profile which may include a device profile, a user profile, a network profile, an encoding profile, and the like. The combination of web content with optimization as herein described may further be combined with one or more of unicast/multicast/broadcast seamless switching, advanced encoding and/or transcoding, automated content tagging, content pause and resume, and mediation and settlement.

[0522] Web content may be combined with location information and intelligence that may be associated with a mobile media platform. This combination may be further combined with a consumption profile which may include a device profile, a user profile, a network profile, an encoding profile, and the like. The combination of Web content with location information and intelligence as herein described may further be combined with one or more of unicast/multicast/broadcast seamless switching, advanced encoding and/or transcoding, automated content tagging, content pause and resume, and mediation and settlement.

[0523] Ingestion may be combined with optimization of ingestion, encoding, transcoding, hosting, and/or delivery that may be associated with a mobile media platform. This combination may be further combined with a consumption profile which may include a device profile, a user profile, a network profile, an encoding profile, and the like. The combination of ingestion with optimization as herein described may further be combined with one or more of unicast/multicast/broadcast seamless switching, advanced encoding and/or transcoding, automated content tagging, content pause and resume, and mediation and settlement.

[0524] Ingestion may be combined with an architecture of a mobile media platform. This combination may be further combined with a consumption profile which may include a device profile, a user profile, a network profile, an encoding profile, and the like. The combination of ingestion with a mobile media architecture as herein described may further be combined with one or more of unicast/multicast/broadcast

seamless switching, advanced encoding and/or transcoding, automated content tagging, content pause and resume, and mediation and settlement.

[0525] Ingestion may be combined with business models associated with a mobile media platform. This combination may be further combined with a consumption profile which may include a device profile, a user profile, a network profile, an encoding profile, and the like. The combination of ingestion with business models associated with a mobile media platform as herein described may further be combined with one or more of unicast/multicast/broadcast seamless switching, advanced encoding and/or transcoding, automated content tagging, content pause and resume, and mediation and settlement.

[0526] Content delivery may be combined with one or more of advertising, marketing, advertisement management, and an ad fulfillment engine, any of which may be associated with a mobile media platform. This combination may be further combined with a consumption profile which may include a device profile, a user profile, a network profile, an encoding profile, and the like. The combination of content delivery with one or more of advertising, marketing, advertisement management, and an ad fulfillment engine as herein described may further be combined with one or more of unicast/multicast/broadcast seamless switching, advanced encoding and/or transcoding, automated content tagging, content pause and resume, and mediation and settlement.

[0527] Optimization of ingestion, encoding, transcoding, hosting and delivery may be combined with social networking that may include content referral, rating, gifting, forums, profiles, and lists, and may also be associated with a mobile media platform. This combination may be further combined with a consumption profile which may include a device profile, a user profile, a network profile, an encoding profile, and the like. The combination of optimization of ingestion, encoding, transcoding, hosting and delivery with social networking, as herein described may further be combined with one or more of unicast/multicast/broadcast seamless switching, advanced encoding and/or transcoding, automated content tagging, content pause and resume, and mediation and settlement.

[0528] Optimization of ingestion, encoding, transcoding, hosting and delivery may be combined with one or more of advertising, marketing, advertisement management, and ad fulfillment engine, any of which may be associated with a mobile media platform. This combination may be further combined with a consumption profile which may include a device profile, a user profile, a network profile, an encoding profile, and the like. The combination of optimization of ingestion, encoding, transcoding, hosting and delivery with one or more of advertising, marketing, advertisement management, and ad fulfillment engine, as herein described may further be combined with one or more of unicast/multicast/broadcast seamless switching, advanced encoding and/or transcoding, automated content tagging, content pause and resume, and mediation and settlement.

[0529] Optimization of one or more of ingestion, encoding, transcoding, hosting and delivery may be combined with business models on the platform that may be associated with a mobile media platform. This combination may be further combined with a consumption profile which may include a device profile, a user profile, a network profile, an encoding profile, and the like. The combination of optimization of ingestion, encoding, transcoding, hosting and delivery with

business models on the platform, as herein described may further be combined with one or more of unicast/multicast/broadcast seamless switching, advanced encoding and/or transcoding, automated content tagging, content pause and resume, and mediation and settlement.

[0530] User interface may be combined with one or more of notifications, messages and alerts that may be associated with a mobile media platform. This combination may be further combined with a consumption profile which may include a device profile, a user profile, a network profile, an encoding profile, and the like. The combination of user interface with one or more of notifications, messages, and alerts as herein described may further be combined with one or more of unicast/multicast/broadcast seamless switching, advanced encoding and/or transcoding, automated content tagging, content pause and resume, and mediation and settlement.

[0531] User interface may be combined with content discovery that may be associated with a mobile media platform. This combination may be further combined with a consumption profile which may include a device profile, a user profile, a network profile, an encoding profile, and the like. The combination of user interface with content discovery, as herein described may further be combined with one or more of unicast/multicast/broadcast seamless switching, advanced encoding and/or transcoding, automated content tagging, content pause and resume, and mediation and settlement.

[0532] User interface may be combined with location information and intelligence that may be associated with a mobile media platform. This combination may be further combined with a consumption profile which may include a device profile, a user profile, a network profile, an encoding profile, and the like. The combination of user interface with location information and intelligence, as herein described may further be combined with one or more of unicast/multicast/broadcast seamless switching, advanced encoding and/or transcoding, automated content tagging, content pause and resume, and mediation and settlement.

[0533] User interface may be combined with personalization of user experience, which may include personal entertainment server and interactive programming guide, and may be associated with a mobile media platform. This combination may be further combined with a consumption profile which may include a device profile, a user profile, a network profile, an encoding profile, and the like. The combination of user interface with personalization of user experience, which may include personal entertainment server and interactive programming guide, as herein described may further be combined with one or more of unicast/multicast/broadcast seamless switching, advanced encoding and/or transcoding, automated content tagging, content pause and resume, and mediation and settlement.

[0534] User interface may be combined with one or more of advertising, marketing, advertisement management; and ad fulfillment engine, any of which may be associated with a mobile media platform. This combination may be further combined with a consumption profile which may include a device profile, a user profile, a network profile, an encoding profile, and the like. The combination of user interface with one or more of advertising, marketing, advertisement management, and ad fulfillment engine, as herein described may further be combined with one or more of unicast/multicast/broadcast seamless switching, advanced encoding and/or transcoding, automated content tagging, content pause and resume, and mediation and settlement.

[0535] User interface may be combined with integration with other systems that may include carrier systems and search engines, and may be associated with a mobile media platform. This combination may be further combined with a consumption profile which may include a device profile, a user profile, a network profile, an encoding profile, and the like. The combination of user interface with integration with other systems that may include carrier systems and search engines, as herein described may further be combined with one or more of unicast/multicast/broadcast seamless switching, advanced encoding and/or transcoding, automated content tagging, content pause and resume, and mediation and settlement.

[0536] One or more of notifications, messages, and alerts may be combined with personalization of user experience which may include personal entertainment server and interactive programming guide and may be associated with a mobile media platform. This combination may be further combined with a consumption profile which may include a device profile, a user profile, a network profile, an encoding profile, and the like. The combination of one or more of notifications, messages, and alerts with personalization of user experience, as herein described may further be combined with one or more of unicast/multicast/broadcast seamless switching, advanced encoding and/or transcoding, automated content tagging, content pause and resume, and mediation and settlement.

[0537] Content discovery may be combined with rights management that may be associated with a mobile media platform. This combination may be further combined with a consumption profile which may include a device profile, a user profile, a network profile, an encoding profile, and the like. The combination of content discovery with rights management, as herein described may further be combined with one or more of unicast/multicast/broadcast seamless switching, advanced encoding and/or transcoding, automated content tagging, content pause and resume, and mediation and settlement.

[0538] One or both of location information and location intelligence may be combined with personalization of user experience which may include personal entertainment server and interactive programming guide, and may be associated with a mobile media platform. This combination may be further combined with a consumption profile which may include a device profile, a user profile, a network profile, an encoding profile, and the like. The combination of one or both of location information and location intelligence with personalization of user experience, as herein described may further be combined with one or more of unicast/multicast/broadcast seamless switching, advanced encoding and/or transcoding, automated content tagging, content pause and resume, and mediation and settlement.

[0539] One or both of location information and location intelligence may be combined with social networking that may include content referral, rating, gifting, forums, profiles, and lists and may be associated with a mobile media platform. This combination may be further combined with a consumption profile which may include a device profile, a user profile, a network profile, an encoding profile, and the like. The combination of one or both of location information and location intelligence with social networking, as herein described may further be combined with one or more of unicast/multicast/broadcast seamless switching, advanced encoding and/or

or transcoding, automated content tagging, content pause and resume, and mediation and settlement.

[0540] One or both of location information and location intelligence may be combined with rights management that may be associated with a mobile media platform. This combination may be further combined with a consumption profile which may include a device profile, a user profile, a network profile, an encoding profile, and the like. The combination of one or both of location information and location intelligence with rights management, as herein described may further be combined with one or more of unicast/multicast/broadcast seamless switching, advanced encoding and/or transcoding, automated content tagging, content pause and resume, and mediation and settlement.

[0541] One or both of location information and intelligence may be combined with one or more of advertising, marketing, advertisement management, and ad fulfillment engine that may be associated with a mobile media platform. This combination may be further combined with a consumption profile which may include a device profile, a user profile, a network profile, an encoding profile, and the like. The combination of one or both of location information and location intelligence with one or more of advertising, marketing, advertisement management and ad fulfillment engine, as herein described, may further be combined with one or more of unicast/multicast/broadcast seamless switching, advanced encoding and/or transcoding, automated content tagging, content pause and resume, and mediation and settlement.

[0542] Personalization of user experience that may include personal entertainment server and interactive programming guide may be combined with one or more of advertising, marketing, advertisement management, ad fulfillment engine and any of which may be associated with a mobile media platform. This combination may be further combined with a consumption profile which may include a device profile, a user profile, a network profile, an encoding profile, and the like. The combination of personalization of user experience with one or more of advertising, marketing, advertisement management, ad fulfillment engine as herein described, may further be combined with one or more of unicast/multicast/broadcast seamless switching, advanced encoding and/or transcoding, automated content tagging, content pause and resume, and mediation and settlement.

[0543] Personalization of user experience that may include personal entertainment server and interactive programming guide may be combined with integration with other systems that includes carrier systems and search engines and may be associated with a mobile media platform. This combination may be further combined with a consumption profile which may include a device profile, a user profile, a network profile, an encoding profile, and the like. The combination of personalization of user experience with integration with other systems that may include carrier system and search engines as herein described, may further be combined with one or more of unicast/multicast/broadcast seamless switching, advanced encoding and/or transcoding, automated content tagging, content pause and resume, and mediation and settlement.

[0544] Personalization of user experience that may include personal entertainment server and interactive programming guide may be combined with architecture of the platform that may be associated with a mobile media platform. This combination may be further combined with a consumption profile which may include a device profile, a user profile, a network profile, an encoding profile, and the like. The combination of

personalization of user experience that may include personal entertainment server and interactive programming guide with architecture of the platform as herein described may further be combined with one or more of unicast/multicast/broadcast seamless switching, advanced encoding and/or transcoding, automated content tagging, content pause and resume, and mediation and settlement.

[0545] Personalization of user experience that may include personal entertainment server and interactive programming guide may be combined with distribution or channel applications that may be associated with a mobile media platform. This combination may be further combined with a consumption profile which may include a device profile, a user profile, a network profile, an encoding profile, and the like. The combination of personalization of user experience that may include personal entertainment server and interactive programming guide with distribution or channel applications as herein described, may further be combined with one or more of unicast/multicast/broadcast seamless switching, advanced encoding and/or transcoding, automated content tagging, content pause and resume, and mediation and settlement.

[0546] Personalization of user experience that may include personal entertainment server and interactive programming guide may be combined with users of the platform that may be associated with a mobile media platform. This combination may be further combined with a consumption profile which may include a device profile, a user profile, a network profile, an encoding profile, and the like. The combination of personalization of user experience that may include personal entertainment server and interactive programming guide with users of the platform as herein described may further be combined with one or more of unicast/multicast/broadcast seamless switching, advanced encoding and/or transcoding, automated content tagging, content pause and resume, and mediation and settlement.

[0547] Personalization of user experience that may include personal entertainment server and interactive programming guide may be combined with business models on the platform that may be associated with a mobile media platform. This combination may be further combined with a consumption profile which may include a device profile, a user profile, a network profile, an encoding profile, and the like. The combination of personalization of user experience that may include personal entertainment server and interactive programming guide with business models on the platform as herein described, may further be combined with one or more of unicast/multicast/broadcast seamless switching, advanced encoding and/or transcoding, automated content tagging, content pause and resume, and mediation and settlement.

[0548] Social networking that may include content referral, rating, gifting, forums, profiles, and lists may be combined with one or more of advertising, marketing, advertisement management, and ad fulfillment engine that may be associated with a mobile media platform. This combination may be further combined with a consumption profile which may include a device profile, a user profile, a network profile, an encoding profile, and the like. The combination of social networking with one or more of advertising; marketing; advertisement management; ad fulfillment engines herein described may further be combined with one or more of unicast/multicast/broadcast seamless switching, advanced encoding and/or transcoding, automated content tagging, content pause and resume, and mediation and settlement.

[0549] E-commerce or e-billing may be combined with rights management that may be associated with a mobile media platform. This combination may be further combined with a consumption profile which may include a device profile, a user profile, a network profile, an encoding profile, and the like. The combination of E-commerce or e-billing with rights management as herein described may further be combined with one or more of unicast/multicast/broadcast seamless switching, advanced encoding and/or transcoding, automated content tagging, content pause and resume, and mediation and settlement.

[0550] Reporting may be combined with one or more of advertising, marketing, advertisement management, and ad fulfillment engine that may be associated with a mobile media platform. This combination may be further combined with a consumption profile which may include a device profile, a user profile, a network profile, an encoding profile, and the like. The combination of reporting with one or more of advertising, marketing, advertisement management, and ad fulfillment engine, as herein described may further be combined with one or more of unicast/multicast/broadcast seamless switching, advanced encoding and/or transcoding, automated content tagging, content pause and resume, and mediation and settlement.

[0551] Administration that may include administration UI, may be combined with integration with other system that may include carrier systems and search engines that may be associated with a mobile media platform. This combination may be further combined with a consumption profile which may include a device profile, a user profile, a network profile, an encoding profile, and the like. The combination of administration, that may include administration UI, with integration with other system as herein described, may further be combined with one or more of unicast/multicast/broadcast seamless switching, advanced encoding and/or transcoding, automated content tagging, content pause and resume, and mediation and settlement.

[0552] One or more of advertising, marketing, advertisement management and ad fulfillment engine, may be combined with integration with other system that may include carrier systems and search engines and may be associated with a mobile media platform. This combination may be further combined with a consumption profile which may include a device profile, a user profile, a network profile, an encoding profile, and the like. The combination of one or more of advertising, marketing, advertisement management, and ad fulfillment engine with integration with other system, as herein described may further be combined with one or more of unicast/multicast/broadcast seamless switching, advanced encoding and/or transcoding, automated content tagging, content pause and resume, and mediation and settlement.

[0553] One or more of advertising, marketing, advertisement management, and ad fulfillment engine may be combined with architecture of the platform that may be associated with a mobile media platform. This combination may be further combined with a consumption profile which may include a device profile, a user profile, a network profile, an encoding profile, and the like. The combination of one or more of advertising, marketing, advertisement management, and ad fulfillment engine with architecture of the platform, as herein described may further be combined with one or more of unicast/multicast/broadcast seamless switching, advanced

encoding and/or transcoding, automated content tagging, content pause and resume, and mediation and settlement.

[0554] One or more of advertising, marketing, advertisement management, and ad fulfillment engine may be combined with business models on the platform that may be associated with a mobile media platform. This combination may be further combined with a consumption profile which may include a device profile, a user profile, a network profile, an encoding profile, and the like. The combination of one or more of advertising, marketing, advertisement management, ad fulfillment engine with business models on the platform as herein described may further be combined with one or more of unicast/multicast/broadcast seamless switching, advanced encoding and/or transcoding, automated content tagging, content pause and resume, and mediation and settlement.

[0555] Security may be combined with one or more of purchasing, shopping and store front applications that may be associated with a mobile media platform. This combination may be further combined with a consumption profile which may include a device profile, a user profile, a network profile, an encoding profile, and the like. The combination of security with one or more of purchasing, shopping and store front applications, as herein described may further be combined with one or more of unicast/multicast/broadcast seamless switching, advanced encoding and/or transcoding, automated content tagging, content pause and resume, and mediation and settlement.

[0556] Billing may be combined with integration with other system that may include carrier systems and search engines and may be associated with a mobile media platform. This combination may be further combined with a consumption profile which may include a device profile, a user profile, a network profile, an encoding profile, and the like. The combination of billing with integration with other system, as herein described may further be combined with one or more of unicast/multicast/broadcast seamless switching, advanced encoding and/or transcoding, automated content tagging, content pause and resume, and mediation and settlement.

[0557] Architecture of the platform may be combined with one or more of purchasing, shopping and store front applications that may be associated with a mobile media platform. This combination may be further combined with a consumption profile which may include a device profile, a user profile, a network profile, an encoding profile, and the like. The combination of architecture of the platform with one or more of purchasing, shopping and store front applications, as herein described may further be combined with one or more of unicast/multicast/broadcast seamless switching, advanced encoding and/or transcoding, automated content tagging, content pause and resume, and mediation and settlement.

[0558] One or more of purchasing, shopping and store front applications may be combined with distribution or channel applications that may be associated with a mobile media platform. This combination may be further combined with a consumption profile which may include a device profile, a user profile, a network profile, an encoding profile, and the like. The combination of one or more of purchasing, shopping and store front applications with distribution or channel applications, as herein described may further be combined with one or more of unicast/multicast/broadcast seamless switching, advanced encoding and/or transcoding, automated content tagging, content pause and resume, and mediation and settlement.

[0559] Users of the platform may be combined with business models on the platform that may be associated with a mobile media platform. This combination may be further combined with a consumption profile which may include a device profile, a user profile, a network profile, an encoding profile, and the like. The combination of users of the platform with business models on the platform as herein described, may further be combined with one or more of unicast/multicast/broadcast seamless switching, advanced encoding and/or transcoding, automated content tagging, content pause and resume, and mediation and settlement.

[0560] FIG. 50 provides an embodiment of the architecture for the media platform 100. A media platform 100 may include a multimedia system that provides for services associated with the collection, ingestion, encoding, distribution, consumption, mediation and settlement, and usage reporting of video and advertising content in association with users operating on a mobile communication facility 5002. As shown, the media platform 100 may follow a client-server architecture, where third-parties provide the interface between the mobile communication facility 5002, such as user mobile handsets 5002, and the media platform 100.

[0561] Media, such as a video, may first be supplied to the media platform 100 through a feed and content drop off 5004. Ingestion of the content into the media platform may include a collection agent 5008 that parses RSS feed and content to collect physical files including content and advertisements. As a result, the collection agent 5008 may be able to provide updates for advertisements and content information to the consumption data store 5012. The reception of new content may then initiate video encoding to start. The video encoder 5010, after completing encoding, may upload encoded advertisements and video to the streaming server 5020.

[0562] In embodiments, user consumption of the content may include a web application for looking up content and advertisements by identification number, generating playlists and configuration files for streaming, and initiating streaming execution. In addition, reports may be generated in association with the content consumption. Other components within the media platform 100 may include a content/advertisement and consumption data storage 5012, a file system 5014, an Sftp drop-off server 5018, application server 5022, and the like. In addition, third party components may include an ad server database 5028, a user profile database 204, a WAP deck 5032 for interfacing with user handsets 5002, and the like. In embodiments, the user interface may be directed from the media platform, or made through third party environments.

[0563] In embodiments, ingestion may use a collection agent 5008 and involve the ingesting of advertisements and video. The preconditions for the use of the collection agent 5008 may include the successful placement of content in the drop off folder 5004, where the collection agent 5008 may then pick up the feed, update content and advertisement data, store for mapping, parse the feed, pass video to encoder 5010, and the like. The encoder 5010 may then be initiated for the start of encoding, where raw videos may use specified encoding profiles. When encoding is complete, the encoder 5010 may place new video in a folder for publishing on the streaming server 5020. At this point in the process, the content and advertisements may be available for viewing and streaming to users' handsets 5002.

[0564] In embodiments, a user may request a playlist for content consumption through a third party, where an action code, subscriber ID, content list, and the like, may be submit-

ted via HTTP. The process may include a plurality of steps, such as checking the content database to look up a content file name by ID, checking the streaming folder to determine if requested contents are available, generating playlist files from a request, determining which port to use for streaming, generating configuration, executing a command to create streaming, insertion of consumption records including playlist and subscriber ID, returning success or failure response back the third party, and the like.

[0565] The media platform **100** may be multi-capability, componentized, and provide many essential services for wireless applications, such as for content ingestion from users, content consumption by users, and usage reporting. FIG. **51** provides a high level block diagram for the media platform **100**, where a content API servlet **5102** may interface with content management **5104** and ingestion services **118** providing data access components **5110** that may further interface with an open video database **5012**. In turn the file system **5014** may interface with the streaming server **5020**, the encoder **5010**, and the collection agent **5008**, and interface back with the data access components **5110**. In embodiments, the collection agent **5008** may represent the demarcation point between the media platform **100** and the third party environments, where a specific collection agent **5008** may serve many content categories and advertisements, such as for news, fun, sport, music, USC, advertising contents, and the like.

[0566] FIG. **52** provides a high level block diagram for the media platform's ingestion services. Here the collection agent **5008** may get a new XML data feed and content files from the drop-off location **5004**, such as from a content provider. The collection agent may then pass the raw video files to the encoder **5010** which may be responsible for rendering the video into various 3GP profiles. In embodiments, the content agent **5008** may parse the XML feed and generate the appropriate objects, as well as provide information processing, such as inserting ads and content into data store within the media platform **100** environment, deploy the formatted videos within the media platform **100** environment (and may include the streaming server), and the like.

[0567] FIG. **53** provides a content agent sequence diagram. Here, it is shown how the collection agent **5008** receives the download from the content drop off location **5004** where it is parsed and may also provide updates to the content information in data storage **5012**. Then the content may be sent to the video encoder **5010**, encoded, and sent off to the publishing agent **5008B**. The encoded video may then be sent to the streaming server **5020** to be made available to users.

[0568] FIG. **54** provides a block diagram of the encoding process. The encoder **5010** may create multiple formats based on profiles defined in the system. Once the videos are encoded, they may be picked by the partner agent and published to production along with metadata descriptors. FIG. **54** shows how the collection agent sends the raw media and XML data on to external storage **5402**, and then on to formatting, such as raw media formatting **5404** and, if necessary, to an intermediate AVI file **5408**. The files are then video encoded **5010A** and advertisement encoded **5010B**, and sent back to external storage **5402**. The publishing agent **5008B** may then take the encoded files from external storage **5402** to be made available to the streaming server **5020**. The video encoder listens on an input SFTP location, which may be implemented using a cron job that invokes the video encoder **5010** each minute to check if files that need to be encoded are

present. If they are present, the video encoder may encode them. While encoding, it may or may not check for more files. The video encoder may then publish encoded media to a remote SFTP location, from where the collection/publishing agent may pick them up and move them over to the streaming server **5020**.

[0569] In embodiments, the encoding process may include a content duration extraction. In this case the encoder **5010** may be required to analyze the duration of the sources content. A new set of instructions may need to be executed before the encoding process begins. In addition, a new tag may be added to support the duration extraction. In embodiments, the encoding process may include various encoding profiles, and the encoder may be capable of supporting additional profiles, where new profiles may be added manually to the configuration file video converter when required. An encoding profile may be a set of instructions that may need to be executed in order to encode a raw media file (source) to an encoded media file (destination). An encoding profile may have a tag, where each profile may contain a name, network type, and encoding configuration settings. Tags may contain actual commands that run through the operating system command line. Every parameter tag may contain an ID attribute, which may be a sequence number the command is run in. Commands may be enclosed, since they may contain characters that have corrupt XML syntax. In addition, tokens may be used, and replaced with actual values at runtime.

[0570] FIG. **55** provides a video encoding utility lifecycle **600** diagram, where the encoder **5010** is started by a job that invokes a shell script. In embodiments, the job may run periodically, such as once per minute, and proceed through a routine for running the encoder. For instance, and as depicted in FIG. **55**, it may first determine whether the encoder **5010** is running, if it is then the encoder may be left to resume encoding. If it is not running, then the encoder may be started, and a check may be made for new raw media files for encoding. In embodiments, the video encoder **5010** may publish encoded media to a remote location, from where the publishing agent **5008B** may pick up and move the encoded media to the streaming server **5020**. In embodiments, third party components may have specific requirements for the response to submission and publication, and the media platform **100** may integrate with their APIs to indicate a success or failure. Other codes may include RSS error, content not found, content name error, guidance exist error, encoding error, internal submission error, internal publishing error, lost Guidance error, database error, file error, unsupported format error, and the like. In embodiments, third party components may be notified by email for submission and publication and the stats code and messages may be included in the email.

[0571] In embodiments, the media platform may include a servlet **5102**. With the servlet **5102** the client may use multiple action codes to request information from the server side. The content consumption servlet **5102** may take in action codes while capturing the transaction method, that is, getting a file or posting a file, and a success or failure response may also be sent back to the client. In embodiments, the servlet may include content management. There may be content managers (interfaces with their corresponding implementation classes) used to manage content in the database (i.e. store, delete, and modify content) and content browsers (again, interfaces with their corresponding implementation classes) used to retrieve content stored in the database. In embodiments, content browsers may mostly be used by the

Servlet to hand data over to third party components. Client requests may come in URL format with parameters tagged to the base URL of the Servlet as name-value pairs. Data may be sent by the content servlet to the client in a format with the URL, where the action IDs used in the requests may be static values agreed upon between the client and the server, and representative of the application operations.

[0572] In embodiments, action types may use and may include playlist requests, content availability checks, and the like. Playlist requests may list the ID for advertisements or content to be played in the requested order, and the subscriber ID and playlist information may be stored in data store for reporting. A content availability check may be an advertisement or content being checked for being ingested in the system. A content Consumption API may respond by using HTTP response status codes with a body message. Standard HTTP response codes may be used with the addition of media platform response codes. Examples of response codes may include, success, content not found, invalid request parameter, service unavailable, internal server error, consumption record cannot be generated, database connection problem, playlist cannot be generated, SDP cannot be generated, and the like.

[0573] In embodiments, the media platform may include reporting of customer and content consumptions for streaming. The report may include a customer ID (which may be from the third party), playlist, date time, duration of viewing time, and the like. To fulfill the requirements, data may be captured from steaming log files and consumption records which may have generated when the request came from the third party. An example of a log file may be:

[0574] 192.168.1.151 2007-08-07 18:53:22 192.168.1.22:554/mobile/content/provider/1186512465939.sdp 3 121 1 504 192.168.1.151 7.2-

[0575] QUICKTIME/7.2%20(qtver=7.2; os=WINDOWS%20NT%205.1Service%20Pack%202) WINDOWS NT%205.1Service%20Pack%202-0 0 0 RTP UDP-H263-1998/90000 287528 0 0 374 0 0 1 3 100 192.168.1.22 to-dev-stream-01.quick-play.local 1 0 subscriberId=11223&playlistId=112334__11223-Streaming%20Server

[0576] 2007-08-07 18:53:22—date time

[0577] 3—Streaming start time

[0578] 121—Streaming end time

[0579] subscriberId=11223&playlistId=112334__11223, extra parameters for subscriber id and playlist id.

[0580] In embodiments, the media platform may also contain consumption records. Consumption records may be database records that may be generated during content consumption. A consumption record may include a playlist ID, subscriber id, a list of guidance Ids, and the like.

[0581] Referring to FIG. 56, the methods and systems of a mobile media platform as herein described may be deployed across geographies and may be adapted to suite requirements associated with the geographies. Security can be established between geographies to further ensure requirements and advantages of the platform in a geography are protected. A deployment of the platform in a particular geography, such as is shown in FIG. 56 may provide advantages to participants in the deployment geography. In an example, a carrier or network provider in Canada may have an advantage over a carrier or provider in another geography because the mobile media is more readily accessible to the Canadian participant.

[0582] The elements depicted in flow charts and block diagrams throughout the figures imply logical boundaries between the elements. However, according to software or hardware engineering practices, the depicted elements and the functions thereof may be implemented as parts of a monolithic software structure, as standalone software modules, or as modules that employ external routines, code, services, and so forth, or any combination of these, and all such implementations are within the scope of the present disclosure. Thus, while the foregoing drawings and description set forth functional aspects of the disclosed systems, no particular arrangement of software for implementing these functional aspects should be inferred from these descriptions unless explicitly stated or otherwise clear from the context.

[0583] Similarly, it will be appreciated that the various steps identified and described above may be varied, and that the order of steps may be adapted to particular applications of the techniques disclosed herein. All such variations and modifications are intended to fall within the scope of this disclosure. As such, the depiction and/or description of an order for various steps should not be understood to require a particular order of execution for those steps, unless required by a particular application, or explicitly stated or otherwise clear from the context.

[0584] The methods or processes described above, and steps thereof, may be realized in hardware, software, or any combination of these suitable for a particular application. The hardware may include a general-purpose computer and/or dedicated computing device. The processes may be realized in one or more microprocessors, microcontrollers, embedded microcontrollers, programmable digital signal processors or other programmable device, along with internal and/or external memory. The processes may also, or instead, be embodied in an application specific integrated circuit, a programmable gate array, programmable array logic, or any other device or combination of devices that may be configured to process electronic signals. It will further be appreciated that one or more of the processes may be realized as computer executable code created using a structured programming language such as C, an object oriented programming language such as C++, or any other high-level or low-level programming language (including assembly languages, hardware description languages, and database programming languages and technologies) that may be stored, compiled or interpreted to run on one of the above devices, as well as heterogeneous combinations of processors, processor architectures, or combinations of different hardware and software.

[0585] Thus, in one aspect, each method described above and combinations thereof may be embodied in computer executable code that, when executing on one or more computing devices, performs the steps thereof. In another aspect, the methods may be embodied in systems that perform the steps thereof, and may be distributed across devices in a number of ways, or all of the functionality may be integrated into a dedicated, standalone device or other hardware. In another aspect, means for performing the steps associated with the processes described above may include any of the hardware and/or software described above. All such permutations and combinations are intended to fall within the scope of the present disclosure.

[0586] While the invention has been disclosed in connection with the preferred embodiments shown and described in detail, various modifications and improvements thereon will become readily apparent to those skilled in the art. Accord-

ingly, the spirit and scope of the present invention is not to be limited by the foregoing examples, but is to be understood in the broadest sense allowable by law.

[0587] All documents referenced herein are hereby incorporated by reference.

1-100. (canceled)

101. A method of managing delivery of content, comprising:

- configuring a content item for delivery based on a consumption profile for the content item comprising attributes of devices on which the content item can be accessed, a profile of networks on which the content item can be delivered, and attributes of the content item;
- initiating delivery of the configured content item over a network;
- receiving an indication of an action for pausing the delivery; and
- pausing delivery of the configured content item based on the received indication and the consumption profile for the content item.

102. The method of claim 101, wherein pause markers are maintained as part of the consumption profile.

103. The method of claim 101, wherein the pausing delivery of the configured content item is based on location-related rules present in the consumption profile.

104. The method of claim 101, wherein the pausing delivery of the configured content item is based on pause-related user preferences present in the consumption profile.

105. The method of claim 101, wherein the pausing delivery of the configured content item is based on pause markers present in the consumption profile for the content item.

106. The method of claim 101, wherein the consumption profile is affected by pausing delivery of the configured content.

107. The method of claim 106, wherein the indication of an action for pausing delivery of the configured content item is an indication of a network based action.

108. The method of claim 107, wherein a network based action causes pausing delivery of the configured content item being presented on a mobile device without the user taking any action.

109. The method of claim 108, wherein the network based action is based on at least one of network bandwidth limitations, duration of a session, and signal quality.

110. The method of claim 101, wherein an action for pausing the delivery is a device related.

111. The method of claim 110, wherein the device related action includes at least one of battery power being low, a unit turning off due to battery power, a loss of signal, and a pause timeout exceeding a device determined threshold.

112. The method of claim 101, wherein the pausing delivery of the configured content item occurs after a trial duration.

113. The method of claim 112, further comprising presenting a user with options for resuming the content.

114. The method of claim 113, wherein the options include at least one of submitting a form of payment, agreeing to perform an action, providing demographic information, and agreeing to receive additional content.

115. The method of claim 101, wherein the pausing delivery of the configured content item occurs when a credit account has insufficient funds to continue playback.

116. The method of claim 115, wherein the pausing delivery of the configured content item includes a location based factor.

117. The method of claim 116, wherein the location based factor is associated with at least one of a secure zone, a blackout area, and a proximity of a playback device for the configured content item to other devices.

118. The method of claim 101, wherein the pausing delivery of the configured content item facilitates managing content sourcing.

119. The method of claim 118, wherein managing content sourcing includes pausing a streaming configured content item from a first source then resuming from a second source different than the first source.

120. A method of managing delivery of content, comprising:

- receiving an indication of an action for resuming delivery of a content item that is configured based on a consumption profile of the content item, wherein the content item was previously paused during delivery over a network;
- accessing the consumption profile that includes attributes of devices on which the content item can be accessed, a profile of networks on which the content item can be delivered, and attributes of the content item; and
- resuming delivery of the configured content item based on the received indication and at least one of the attributes of devices on which the content item can be accessed, a profile of networks on which the content item can be delivered, and attributes of the content item accessed in the consumption profile for the content item.

121. The method of claim 120, wherein resuming delivery of the configured content item is based on location-related rules present in the consumption profile for the content item.

122. A method of managing delivery of content, comprising:

- configuring a content item for delivery based on a consumption profile for the content item comprising attributes of devices on which the content item can be accessed, a profile of networks on which the content item can be delivered, and attributes of the content item;
- initiating delivery of the configured content item over a network;
- receiving an indication of an action for pausing the delivery;
- pausing delivery of the configured content item based on the received indication and the consumption profile for the content item;
- receiving an indication of an action for resuming delivery of the configured content item;
- resuming delivery of the configured content item based on the receiving the indication of the action for resuming delivery of the configured content item and the consumption profile for the configured content item.

123. The method of claim 122, wherein the consumption profile is affected by pausing delivery and resuming delivery of the configured content.

124. The method of claim 122, wherein a position at which pausing delivery of the configured content item occurs is calculated based on an algorithm for placement of an advertisement.

125. The method of claim 124, wherein the algorithm identifies a change of scene in the configured content item.

126. The method of claim 125, wherein image analysis determines the change of scene.