

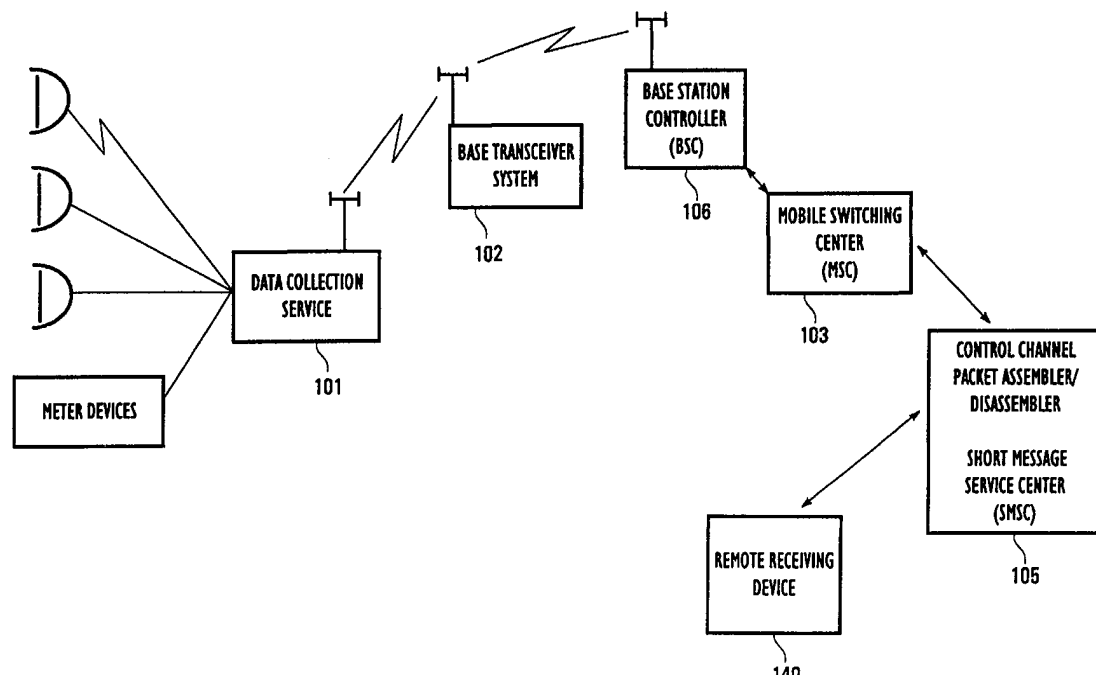

INTERNATIONAL APPLICATION PUBLISHED UNDER THE PATENT COOPERATION TREATY (PCT)

| | | |
|--|---|--|
| <p>(51) International Patent Classification ⁶ : H04M 11/04, G08C 15/06, 19/20, 19/22, H04M 11/00, H04Q 7/00, 9/00, G06F 17/50, G06G 7/62</p> | <p>A1</p> | <p>(11) International Publication Number: WO 98/19447 (43) International Publication Date: 7 May 1998 (07.05.98)</p> |
| <p>(21) International Application Number: PCT/US97/19406 (22) International Filing Date: 28 October 1997 (28.10.97) (30) Priority Data: 08/740,361 28 October 1996 (28.10.96) US 08/920,085 26 August 1997 (26.08.97) US (71) Applicant (for all designated States except US): TRACY CORPORATION II [US/US]; P.O. Box 1225, Scottsbluff, NE 69363-1225 (US). (72) Inventors; and (75) Inventors/Applicants (for US only): TRACY, Michael, J. [US/US]; 731 East 38th Street, Scottsbluff, NE 69363 (US). HINZE, Robert, L. [US/US]; 1685 Bonanza Street, Gering, NE 69341 (US). (74) Agents: TOMPKINS, Michael, L. et al.; Sheridan Ross P.C., Suite 3500, 1700 Lincoln Street, Denver, CO 80203-4501 (US).</p> | <p>(81) Designated States: AL, AM, AT, AU, AZ, BA, BB, BG, BR, BY, CA, CH, CN, CU, CZ, DE, DK, EE, ES, FI, GB, GE, GH, HU, ID, IL, IS, JP, KE, KG, KP, KR, KZ, LC, LK, LR, LS, LT, LU, LV, MD, MG, MK, MN, MW, MX, NO, NZ, PL, PT, RO, RU, SD, SE, SG, SI, SK, SL, TJ, TM, TR, TT, UA, UG, US, UZ, VN, YU, ZW, ARIPO patent (GH, KE, LS, MW, SD, SZ, UG, ZW), Eurasian patent (AM, AZ, BY, KG, KZ, MD, RU, TJ, TM), European patent (AT, BE, CH, DE, DK, ES, FI, FR, GB, GR, IE, IT, LU, MC, NL, PT, SE), OAPI patent (BF, BJ, CF, CG, CI, CM, GA, GN, ML, MR, NE, SN, TD, TG).</p> <p>Published <i>With international search report. Before the expiration of the time limit for amending the claims and to be republished in the event of the receipt of amendments.</i></p> | |

(54) Title: TELECOMMUNICATIONS INTERFACE AND ASSOCIATED METHOD FOR COLLECTING AND TRANSMITTING DATA



(57) Abstract

A system for remotely monitoring and transmitting data as shown in figure 1. The system includes devices for sensing and collecting data (120) and for converting the data (154) to digital data and a processing unit (154) for processing the data. The data can be digitally transmitted over a GSM or TDMA technology digital network (320) via a control channel (105).

FOR THE PURPOSES OF INFORMATION ONLY

Codes used to identify States party to the PCT on the front pages of pamphlets publishing international applications under the PCT.

| | | | | | | | |
|----|--------------------------|----|--|----|--|----|--------------------------|
| AL | Albania | ES | Spain | LS | Lesotho | SI | Slovenia |
| AM | Armenia | FI | Finland | LT | Lithuania | SK | Slovakia |
| AT | Austria | FR | France | LU | Luxembourg | SN | Senegal |
| AU | Australia | GA | Gabon | LV | Latvia | SZ | Swaziland |
| AZ | Azerbaijan | GB | United Kingdom | MC | Monaco | TD | Chad |
| BA | Bosnia and Herzegovina | GE | Georgia | MD | Republic of Moldova | TG | Togo |
| BB | Barbados | GH | Ghana | MG | Madagascar | TJ | Tajikistan |
| BE | Belgium | GN | Guinea | MK | The former Yugoslav Republic of Macedonia | TM | Turkmenistan |
| BF | Burkina Faso | GR | Greece | | | TR | Turkey |
| BG | Bulgaria | HU | Hungary | ML | Mali | TT | Trinidad and Tobago |
| BJ | Benin | IE | Ireland | MN | Mongolia | UA | Ukraine |
| BR | Brazil | IL | Israel | MR | Mauritania | UG | Uganda |
| BY | Belarus | IS | Iceland | MW | Malawi | US | United States of America |
| CA | Canada | IT | Italy | MX | Mexico | UZ | Uzbekistan |
| CF | Central African Republic | JP | Japan | NE | Niger | VN | Viet Nam |
| CG | Congo | KE | Kenya | NL | Netherlands | YU | Yugoslavia |
| CH | Switzerland | KG | Kyrgyzstan | NO | Norway | ZW | Zimbabwe |
| CI | Côte d'Ivoire | KP | Democratic People's Republic of Korea | NZ | New Zealand | | |
| CM | Cameroon | | | PL | Poland | | |
| CN | China | KR | Republic of Korea | PT | Portugal | | |
| CU | Cuba | KZ | Kazakstan | RO | Romania | | |
| CZ | Czech Republic | LC | Saint Lucia | RU | Russian Federation | | |
| DE | Germany | LI | Liechtenstein | SD | Sudan | | |
| DK | Denmark | LK | Sri Lanka | SE | Sweden | | |
| EE | Estonia | LR | Liberia | SG | Singapore | | |

**TELECOMMUNICATIONS INTERFACE AND ASSOCIATED METHOD FOR
COLLECTING AND TRANSMITTING DATA**

FIELD OF THE INVENTION

The present invention relates generally to the remote
5 monitoring of usage information, and in particular to an
apparatus and associated method for transmitting,
receiving, storing, processing and digitally re-
transmitting the information directly to a remote receiving
device via various methods to include personal
10 communications systems using Global Standards for Mobile
Communications (GSM), Time Division Multiple Access (TDMA)
Technology, Code Division Multiple Access (CDMA), Frequency
Division Multiple Access (FDMA), Personal Access
Communications System (PACS) or any other communication
15 system that employs a digital technology standard for voice
and data communications.

BACKGROUND OF THE INVENTION

Presently, many utility meters are monitored by having
an employee visually inspect each meter, and record the
20 usage data. Several methods and devices have been proposed
to automatically collect the utility usage data thereby
reducing the labor involved in collecting the utility usage
data.

In U.S. Patent No. 4,803,632, Frew, et al. disclose a
25 device for monitoring utility usage. The device is
independently powered and is capable of short range
infrared transmission of the utility usage data. A wand is
also provided that is capable of receiving the transmitted
data. A meter-reading employee uses the wand by placing it
30 close to the monitoring device to receive the data which is
electronically stored in a transportable unit carried by
the employee. The employee then brings the electronically
stored data to the utility company where it is downloaded
from the transportable unit and used to calculate the
35 customer's utility usage bill.

U.S. Patent Nos. 5,010,568 and 5,161,182, by Merrian, et al. disclose a utility usage monitor that connects to the customer's telephone line via a modem. The usage monitor calculates and stores the customer's utility usage data. The utility company periodically calls the monitoring unit, and when a modem connection between the utility company and the monitoring unit is established, the monitoring unit sends the usage data to the utility company and the data is used to calculate the customer's usage bill.

In U.S. Patent No. 4,940,976, Gastouniotis, et al. disclose a device that monitors utility usage data. The customer's utility usage data is collected by a unit located in the customer's residence. The monitoring unit sends the usage data via a radio frequency to an intermediate storage station where usage data from up to 10,000 residences is capable of being stored. Periodically, the intermediate station sends the stored data to the utility company by either a radio frequency link, a cable TV line or telephone line. Subsequently, the utility usage data is used to calculate the customer's bill.

A need exists for a system that is capable of monitoring utility usage and other information on varying reading schedules and different levels of frequency of data interrogation (profiling), and is capable of wirelessly transmitting digital data to a desired remote device.

Accordingly, it would be advantageous to provide a data collection device that receives information from utility meters and other devices.

It would further be advantageous to provide for digital transmission of the information to a remote receiving device, and in one embodiment the information should be capable of being transmitted via GSM, PACS, FDMA, CDMA or TDMA digital technology operating at any frequency.

It would also be advantageous for the data collection device to provide an interface with telecommunications wiring at a location so as to provide a connection to a digital personal communications system or equivalent wireless network.

In addition, it would be advantageous to provide a device that is capable of receiving requests for data and is capable of transmitting data using the short message service of the personal communications system protocol.

It would further be advantageous to provide a device that creates an interface between wire-line telecommunications equipments/systems and a wireless digital PCS telecommunications network where the device operates over a specified frequency bandwidth.

SUMMARY OF THE INVENTION

According to the present invention, an apparatus is provided for automatically collecting data and digitally transmitting that data to a remote receiving device, and the data is capable of being transmitted in one embodiment using GSM, PACS, FDMA, CDMA or TDMA digital technology. These transmission protocols represent mobile telecommunications systems that operate on a specified radio frequency bandwidth that are capable of digital speech and data transmission. The apparatus includes a device for sensing and collecting data at a first location. If the sensed data is analog, then the analog data is converted to digital data. The collected data may be transmitted to a data collection device for storage and/or processing before the data is digitally transmitted to the desired remote device. Within the data collection device is a device for processing and storing which is also used to convert and encode the data into a desired format and electronically store the data. The device for processing and storing can include a central processing unit (CPU) for

processing the collected data, erasable programmable memory (EPROM) for storing a program to process the collected data and random access memory (RAM) for storing the data before it is transmitted.

5 Periodically, or when prompted by an interested party, the apparatus transmits the digital data to a remote receiving device via a telecommunications transceiver unit and network using GSM, PACS, FDMA, CDMA or TDMA digital technology on any radio frequency. The GSM, PACS, FDMA, 10 CDMA or TDMA network may transmit the stored and/or processed data on a digital GSM, PACS, FDMA, CDMA or TDMA control channel or short message system and the data is delivered to the remote receiving device. In one embodiment, the apparatus is capable of transmitting the 15 data over the personal communications system network utilizing frequencies of about 1900 MHz.

 Although the present invention is described in relation to personal communications system networks using GSM, PACS, FDMA, TDMA or CDMA technology, it should be 20 appreciated that personal communication systems may encompass any other wireless system that employs the use of a digital transmission technology to transmit information to a remote receiving device.

 In another embodiment, the apparatus for automatically 25 collecting data can be connected via a connecting device to telecommunications systems or equipment (e.g., existing hardwired telephone system) to create a connection to a wireless telecommunications network (e.g., GSM, PACS, FDMA, TDMA or Code Division Multiple Access (CDMA) network). 30 Thus, a connection in this manner allows for voice or data transmission over the wireless telecommunications network using the existing telecommunications systems or equipment wiring at a location.

 In addition, the collected meter usage data can be 35 electronically stored within the optical meter reading

device. The collected data can be subsequently transmitted to another location via a wired or wireless connection. The wireless transmission of collected data may be sent over a frequency band that has not been licensed for commercial use. The transmitted data is capable of being received by the data collection device and subsequently digitally transmitted.

In another aspect of the invention, data is transmitted to and from the data collection device using the short message service portion of digital technologies used for digital voice and data communications, (e.g., GSM, PACS, FDMA, TDMA or CDMA). The short message service portion of these digital transmission protocols is a means to send a protocol specific number of characters of data to and from mobile subscribers (MS), i.e. a device capable of transmitting via a personal communications system. A method for transmitting a data sequence via a personal communications system short message service transmission protocol is disclosed. The method includes first transmitting a request for data from a remote device to the data collection device using the short message service portion of the personal communications system transmission protocol. The request is received at the data collection device and interpreted. According to the interpretation of the request, the data collection device compiles the data that was requested by the remote device. The compiled data is then transmitted to the remote device using the control channel of the short message service portion of the personal communications system transmission protocol.

On request from the remote device the compiled data consists of data received by the data collection device. This data is then stored as it is received, with the capability of using a time stamp functionality. This time stamp device provides electronic circuitry that is capable of providing a time relationship to the data that is

capable of being stored in electronic memory in the collection device for compilation and release on query from the remote device. The time stamping enables the data to bear a relationship to the period of time over and during which it may have been collected. This time relationship is useful in developing usage profiles for later reporting or consumption profiles of data which might reflect the period of time during which items were consumed, the consumption was monitored and consumption data was collected, stored and held in the data collection device. The various parameters would include but would not be limited to frequency of collection, related time stamping, and notification of consumption. Each of these specified parameters may be changed or altered on request and in conformance with requests and instructions received from the remote device.

The step of transmitting the request for data includes accessing the short message service portion of the personal communications system transmission protocol. The data sequence is transmitted by the remote device to the data collection device via the short message service portion of the personal communications system transmission protocol. The short message service data is received by the data collection unit and the request for data is interpreted. When the data has been compiled according to the request, the data collection unit accesses the short message service portion of the personal communications system transmission protocol. The compiled data is formatted as a short message containing the data which was previously requested from the remote device. The data sequence is transmitted from the data collection device to the remote device using the short message service portion of the personal communications system transmission protocol.

In another aspect of the present invention, a device and method for coupling wire-line telecommunications

equipment/systems to a digital PCS radio receiver/transmitter is provided. The digital PCS radio receiver/transmitter is used in a wireless digital PCS telecommunications network having a remote digital PCS transceiver system. The digital PCS radio receiver/transmitter is further capable of digital radio communication with the remote digital PCS transceiver system. The device includes a wire-line telecommunications equipment/system interface that connects the device with the premise wire-line telecommunications equipment/systems creating a first two-way communications link. A first means for converting is provided that covers data that is input to the wire-line telecommunications equipment/systems from the device. A digital PCS radio receiver/transmitter interface is provided that connects the device to the digital PCS radio receiver/transmitter creating a second two-way communications link. A second means for converting is provided that converts data input to the digital PCS radio receiver/transmitter from the device.

A means for determining the number of telephone number digits to be dialed is provided. The telephone number digits are capable of being input to the wire-line telecommunications equipment/systems. A number of telephone digits are capable of being input to the wire-line telecommunications equipment/systems by a user. The means for determining further includes a first means for receiving, storing and converting a plurality of digits to digital format. The plurality of digits include telephonic number dialing sequences of a length necessary for placing, dialing or accessing the wire-line telecommunications equipment/systems. Each of the first stored numbers is represented by a specific number of digits wherein each of said stored numbers is represented by a specific number of digits to be dialed from the wire-line telecommunications equipment/systems.

A second means for storing is provided that stores the dialed or input telephone digits. The telephone digits are dialed or input from the wire-line telecommunications equipment/systems. A means for sequentially analyzing at least a portion of the dialed telephone digits to the stored numbers. The digits are analyzed until the dialed telephone digits, in sequence, are equal to at least one of the stored numbers, therefore recognizing the dialed number and the numbers to be dialed.

A means for generating a send signal is provided that generates a send signal to the digital PCS radio transmitter/receiver. The send signal is generated after the specified number of digits corresponding to the at least one stored number is dialed.

A means for sending the stored dialed telephone number digits to the digital PCS radio transmitter/receiver. The stored dialed telephone number digits are sent to the digital PCS radio transmitter/receiver after the specified number of telephone number digits corresponding to the at least one stored number is dialed.

In another embodiment, the device and method can further include a means for generating a ring signal to the wire-line telecommunications equipment/system. The ring signal will be generated when a telephone call is made to said wire-line telecommunications equipment/system over the wireless digital PCS telecommunications network. In addition, means for acknowledging and further coupling the wireless digital PCS telecommunications network and the wire-line telecommunications equipment/systems is provided when an off-hook condition is recognized. Further, a data collection device may be interconnected with the device. The data collection device is capable of transmitting data to the device.

In another aspect of the present invention, a device for transmitting and receiving data being conveyed over a

telecommunications network is provided. The device includes a means for converting data sent over the telecommunications network. The data may be converted to be compatible with a PCS short message service protocol.

5 A means for modulating the data sent over the telecommunications network is provided. The data is modulated over a bandwidth. In one embodiment the data is modulated over the bandwidth of 3200 to 3800 Hz. A second means for converting data received from the

10 telecommunications network is provided, and a means for demodulating data received from the network demodulates the data over a bandwidth. Again, in one embodiment, the bandwidth ranges from about 3200 to 3800 Hz.

The personal communications system (PCS) transmission protocol and short message service transmission (SMS) protocol include several standard wireless transmission systems. These systems include a global system for mobility (GSM) technology network, a time division multiple access (TDMA) technology network, a code division multiple

20 access (CDMA) technology network, frequency division multiple access technology network (FDMA) or personal access communications system technology network (PACS), among others. In addition, the method may be used on any wire or wireless transmission system that employs a digital

25 or analog transmission protocol system.

BRIEF DESCRIPTION OF THE DRAWINGS

Fig. 1 is a block diagram of one embodiment of the communications system of the present invention;

Fig. 2 is a block diagram of another embodiment of the communications system of the present invention;

30

Fig. 3 is a block diagram of an data collection device;

Fig. 4 is a block diagram of a remote meter reader;

Fig. 5 is a block and schematic diagram of an embodiment of the data collection device;

Fig. 6 is a block diagram of another embodiment of the communications system of the present invention including date/time stamp electronics and a short message controller.

Fig. 7 is a diagram of the downlink and uplink portions of a GSM technology based control channel data sequence.

Fig. 8 is a diagram illustrating the transmission of data to and from a data collection unit via a personal communications system.

Fig. 9 is a diagram illustrating the telecommunications interface of the present invention.

Fig. 10 is a diagram illustrating the transmission of data over a PCS wireless network and a public switched network.

Fig. 11 is a diagram illustrating one embodiment of the out of band modem of the present invention.

DETAILED DESCRIPTION

One aspect of the invention is directed to an automatic meter reading apparatus for collecting and transmitting utility usage and other information. The data collection device collects data from utility meters and other devices, and the data can be transmitted to the data collection device via a wired or wireless connection. Within the data collection device is a wireless transmitter/receiver that is capable of digitally transmitting the data to a remote device, such as to a remote device located at a utility company, over a personal communications system using GSM, PACS, FDMA, TDMA or CDMA technology and also receiving data from the remote device. The remote device is capable of interrogating individual data collection devices and specific data registers of individual data collection devices because the wireless

telecommunications technology allows each individual data collection device and data register within the device to have an unique address.

Another aspect of the present invention is directed to an improved meter reading device that has an increased depth of focus. The improved reader includes an electromagnetic radiation (e.g. optical or infrared) transmitter and receiver. In addition, a device for reflecting an electromagnetic beam is provided such that the beam is optically coupled between the transmitter, receiver and a rotatable disk, dial or mechanical type indicator provided in a utility meter. The improved meter reader is capable of being integrated into existing meters without having to replace each existing utility meter.

In Fig. 2, a block diagram of an data collection device includes a data collection receiver 110 that is connected to meters or other devices 100. The data collection receiver 110 includes a direct wired input receiver 116 for those meters or other devices 100 that are directly wired to receiver 110, and a super regenerative or spread spectrum receiver 114 is included for those meters or devices 100 that are wirelessly connected to receiver 110. A data collection device 120 is connected to data collection receiver 110 and is capable of calculating and storing usage consumption or status data from any presently existing meter readers or other devices. Also, a GSM, PACS, FDMA, CDMA or TDMA telecommunication unit 130 is connected to the data collection device 120 such that the data received (from the meters 100) is capable of being digitally transmitted over a GSM, PACS, FDMA, CDMA or TDMA digital technology network short message service to a remote device or location 140.

In one embodiment, the data collection device can be miniaturized and located behind an electrical meter. This embodiment contains a transceiver that is capable of

transmitting and receiving information over a digital GSM, PACS, FDMA, CDMA or TDMA network. In addition, this embodiment can also contain a receiver for collection of data from wireless meter readers or other data sources associated with the data collection device.

Referring to Fig. 3, the GSM, PACS, FDMA, CDMA or TDMA telecommunications unit 130 includes a GSM, PACS, FDMA, CDMA or TDMA transmitter/receiver 134 that receives data from the data collection device 120. The GSM, PACS, FDMA, CDMA or TDMA transmitter/receiver is then capable of digitally transmitting data to and from a remote receiving device 140 via the GSM, PACS, FDMA, CDMA or TDMA network control channel or short message service 136. The personal communications system network in most of North America contains spectrum assignments between 1850 to 1990 MHz (referred to herein as the 1900 MHz bandwidth). In a preferred North American embodiment, the GSM, PACS, FDMA, CDMA or TDMA transmitter operates over a frequency range of 1850 to 1990 MHz. It should further be appreciated that the data collection device of the present invention may be used in conjunction with any wireless network that employs a digital control channel or short message service technology for transferring information. In addition to existing wireless network technologies such as personal communications system, GSM, TDMA, CDMA, Frequency Division Multiple Access (FDMA) and Personal Access Communications System (PACS), the present invention is envisioned to be used in connection with other wireless network technologies that may be developed and that employ the use of a digital control channel or short message service type of technology to transfer information.

Referring to Fig. 1, the data from all of the meters 100 is transmitted to the data collection device 101, for example by a wired or radio frequency connection. The data collection device 101 is also capable of receiving data

from meters that have been manufactured by various companies equipped with/for various methods of data collection, retention and subsequent data release. The data from the data collection device 101 is transmitted
5 over a network infrastructure to a base transceiver system (BTS) 102 using a digital control channel or short message service. From the BTS 102, the data is transmitted to a base station controller (BSC) 106. Then from the BSC 106, the data is transmitted to a mobile switching center (MSC)
10 103. A control channel packet assembler/disassembler or short message service center 105 is physically located at the MSC 103. At this location, the data stream is transmitted in a common data format (e.g., Integrated Services Digital Network (ISDN), Short Message Service
15 technology standard service basis (SMS), etc.) Data is transmitted over the technology dependant control channel configurations in continuous transmission units. Each transmission unit contains a specific number of transmission packets (e.g., under GSM personal
20 communications system wireless networks there are five transmission packets per transmission unit). Since the GSM control channel (e.g.) is generally under utilized, many of the transmission packets contain no wireless network transmission information, such packets are known as "dummy"
25 packets.

The embodiment of Fig. 1 shows a GSM control channel packet assembler/disassembler short message service center (SMSC) 105 continuously monitoring GSM data streams and from which can separate the control channel transmission
30 packets necessary for system control or other system information from other channel transmission packets with other characteristics. To this end, it should also be appreciated that although the control channel assembler/disassembler 105 is physically located at the MSC
35 103, it may be logically located at any point between the

BTS 102 and the MSC 103. Each data packet has a "header" which contains a specific numeric configuration which identifies a packet as a "dummy" packet, GSM control packet or a specific data packet. Specific transmission packets transferred to and from the data collection device 101 are detected by the control channel packet assembler/disassembler 105, "stripped", interrogated, quantified and simultaneously replaced by a "dummy" packet which is, then, transmitted to the MSC 103. The "stripped" packets that contain information from the data collection device 101 may be transmitted to the remote receiving device 140 to be processed. Conversely, instructional information for the data collection device 101 may be transferred from the remote receiving device 140 to the control channel packet assembler/disassembler 105 and introduced into the control channel by stripping a dummy packet and inserting a control data packet with the instructional information in the data stream. The instructional information is transmitted back to the data collection device 101 via the MSC 103, BSC 106 and the BTS 102. Accordingly, the control channel packet assembler/disassembler 105 is operated in tandem on both the inbound and outbound control channels between the BSC 106 and the MSC 103. In one embodiment, the control channel packet assembler/disassembler 105 can be a computer that has been programmed to perform the functions mentioned hereinabove.

More specifically, in a configuration utilizing GSM technology the present invention utilizes removal of the "dummy" packets that contain no information and replacing these packets with diverted transmission packets. The diverted transmission packets can contain data and instructions that are used by the remote device to control the individual data collection devices. In addition, the diverted transmission packets can contain data that the

data collection device sends to the remote device. The diverted transmission packets can be diverted between the BTS 102 and the MSC 103. The diverted transmission packets are replaced with "dummy" transmission packets making the operation of this system transparent to the MSC 103. Operating in this manner, the remote receiving device 140 and the data collection device 101 create a two way communications link.

Under the GSM (e.g., PACS, FDMA, CDMA or TDMA technology), there are logical channels and radio frequency channel which are available for communication. Additional channels or portions of logical channels are used as a control channel(s). The (GSM) control channel or its equivalent in other digital technologies including PACS, FDMA, CDMA or TDMA networks is normally used to verify the caller's identification and billing information. In addition, the control channel is used for switching the caller between communication towers typically when the caller is close to becoming out of the range of a transmitting tower. As such, there are times when the control channel or its technical equivalent is not in use by the digital GSM, PACS, FDMA, CDMA or TDMA communications network. During this non-use time, the data collection device 101 is capable of transmitting data over the network system without interfering with other control channel type transmissions. In the present invention, the GSM, PACS, FDMA, CDMA and TDMA control type channel(s) is always fully in use with streams of transmission packets, but the majority of the transmission packets consist of "dummy" transmission packets, as explained hereinabove. The "dummy" packets can be "stripped" from the data stream in route to the BTS 102. The packets that are "stripped" are replaced with dummy transmission packets that contain address and instruction for the data collection device 101. The address information contains a unique address for each

individual data collection device. Therefore, the present invention is capable of communicating with individual data collection devices because information may be sent to the unique address of the desired data collection device. The diverted transmission packets which are received via the GSM, PACS, FDMA, CDMA or TDMA BTS 102 are stripped and not forwarded to the MSC 103. This packet "stripping" allows this system to be installed without software modification to the home location register (HLR), vehicle visitor location register (VLR) or MSC 103. As such, the data collection device 101 is capable of transmitting or receiving data at any prescribed or requested time. Thus, data can be transmitted or received at times when other control channel transmissions are at a minimum. Data transmitted over the control channel or technical equivalent is digital, and therefore the digital data from the data collection device 120 may be transmitted over the GSM, PACS, FDMA, CDMA or TDMA network, and therefore removing the need of a digital-to-analog conversion.

Existing meter interrogation systems are not intelligent and cannot interrogate individual or specific devices. Some systems, through the network transmission system, issue a command to all meters in a certain portion of the network to report. Those zoned meters then transmit data on a sequential (timed) basis. The meters receive this command and then report the data via the wireless network multiple times, independent of any other readings which might be taking place at this same time. This operational theory assumes that the meters' data transmissions will not interfere with each other through this staggered interrogation and transmission scheme, and that one of the multiple readings (if not more) will reach the data collection point in an uncorrupted manner.

In the present invention, the data collection device transmits data when requested to do so by the GSM, PACS,

FDMA, CDMA or TDMA signal. Therefore, it is possible to read specific data registers of single meters without activating all of the meters in a zone to do so. This operation of interrogating meters decreases the amount of traffic on the GSM, PACS, FDMA, CDMA or TDMA communications systems and optimizes the efficiency of the system operation.

Referring to Fig. 4, the meters or other devices 100 may be remotely located from the data collection device 120 (see Figs. 3 and 5) and connected by a wireless data collection unit 148. The data may be collected from meters or other devices by universal meter reading sensor 156. The data is conditioned and preferably encrypted before transmission using signal conditioning electronics 154. Periodically, the transmitter control 152 directs the transmitter 150 to send the data to the super regenerative or spread spectrum receiver 114, shown in Fig. 2. The transmitter 150 is capable of operating on unlicensed radio frequencies, such as 27, 49, 300 or 902-928 MHz using either frequency modulation (FM) or amplitude modulation (AM). Preferably, the transmitter 150 will operate over the frequency range of 902-928 MHz using amplitude modulation.

The transmission of the data from the transmitter 150 to the data collection device 120 (shown in Fig. 2) can be accomplished by using an inductive (L) and capacitive (C) super regenerative circuit, described in detail hereinbelow. The LC circuit is a fairly inexpensive alternative for short distance wireless transmission of data. After the data is sent to the LC receiver 114 (shown in Fig. 2), it may be sent to a remote device or location, as explained hereinabove, using the GSM, PACS, FDMA, CDMA or TDMA telecommunications unit 130, also shown in Fig. 2.

As shown in Fig. 4, the wireless data collection unit 148 can be remotely powered by a battery 158 that can be

charged by a solar cell 162. The charge control unit 160 regulates the power from the solar cell 162 such that battery 158 and super-capacitor 164 are charged. In the event of power loss, the super-capacitor 164 may be used as a backup power source. In another embodiment, the wireless data collection unit is powered by long life batteries.

Referring to Fig. 5, the data collection device 120 further includes a data collection unit 210. In one embodiment, the data collection unit 210 includes a central processing unit (CPU) that has an electronic memory such as erasable programmable read-only memory (EPROM) and a real-time clock. These devices are used to store, time stamp and process the most recent meter output or other data. The data processing program/algorithm that is used by the CPU to process the utility data is stored in the EPROM via program data lines 230, and for security purposes, after initially programming the CPU, the data processing program/algorithm cannot be changed. In the event that the data, the algorithm or any physical part of the data collection device 120 itself is tampered with, the data collection device 120 is capable of detecting the false data or algorithm or physical intrusion and can send a security breach signal to the remote receiving device (e.g., the utility company computers).

The CPU has a plurality of data input and output (I/O) lines. Therefore, the I/O lines that are not in use by the data devices may be used for additional applications. For example, the additional lines may be connected to a home security unit having a number of sensors throughout the home. When a sensor detects an intrusion, the data collection device 120 is capable of transmitting that breach to a remote device located, for example, at a police station. Other home applications include a home health monitoring device that can be capable of detecting the

health status of a patient and transmit that data to a hospital.

In another embodiment, the data collection device may use additional I/O lines to monitor the usage of vending machines or the like. For example, each vending machine located in a building can be capable of transmitting its usage data to the universal meter reading data collection device which, in turn, transmits that usage data to the vending company. Therefore, the vending company can restock the vending machines without wasting manpower by having to manually check each machine. The invention also encompasses applications for irrigation sprinkler systems monitoring and control, oil well monitoring and control, sewage/water monitoring at industrial sites, smokestack emissions monitoring, real-time monitoring of air quality in metropolitan areas, remote weather monitoring and power failure location monitoring.

The utility usage data is obtained from meters 220, and additional data lines 232 are available for monitoring other devices. Meters 220 may be hard-wired or wirelessly connected to the data collection unit 210. When the meters 220 are wirelessly connected, the data is preferably transmitted over unlicensed frequency bands, preferably over the frequencies of 27, 49, 300 or 902-928 MHz.

The data collection device, is capable of reading multiple status and usage inputs compared to other devices which read each device as an individual element. The data collection device conditions the data through the CPU to provide a more efficient usage of technology and spectrum. In addition, the data collection device can interface to many devices with wired or wireless media and inputs.

When using wireless collection between the data collection device and meters being read at a given site, those receivers and transmitters are extremely low in cost, low in technical criteria and are similar to keyless entry

systems. The security and reliability of this low cost system is achieved through CPU error checking in the data collection device. Data from a wireless meter is periodically transmitted multiple times on a variety of
5 closely spaced, unlicensed radio frequencies. The CPU in the data collection device controls a low cost LC super regenerative receiver to rapidly sequence through the frequencies seeking a valid signal to lock to. In another embodiment, the device uses surface acoustic wave filter
10 based transmitters and receivers. When the signal is received and locked, the CPU inspects the data for errors and wireless meter reader serial number prior to accepting and storing the data (in this example a meter reading) for storage and later transmission via the GSM, PACS, FDMA,
15 CDMA or TDMA system to the data collection point.

Furthermore, the data collection device/utility meter reading system is low cost because it utilizes the modification of existing meter infrastructure and simply adds an optical/infrared reader which is much less costly
20 than replacing an installed meter with a meter equipped with reading electronics contained therein. Further, multiple meters and alarms are read or monitored at one site by one data collection device. As explained earlier, through the utilization of the GSM, PACS, FDMA, CDMA or
25 TDMA control packet data or short message service collection system, there are no software modifications necessary to any of the GSM, PACS, FDMA, CDMA or TDMA transmitting or receiving equipment.

As explained above, the transmission of data from the
30 meters 220 to the data collection unit 210 may be accomplished by using an LC super regenerative circuit to create a wireless connection between the unit 210 and the meters 220. In addition, when the meters 220 are wirelessly connected, signal conditioning electronics 234
35 are used to filter any electromagnetic noise in the

transmitted signal. The signal conditioning electronics 234 may also be used when the meters 220 are hard-wired to the connection unit 210 in order to filter noise and deliver a clean logic signal to the data collection unit 210.

Also shown in Fig. 5, opto-triac switch 250 is used for controlling the coil of the load shedding relay contacts 260. The opto-triac is a commercially available device used to isolate sensitive electronic devices from transient surges caused by switching large power loads. One or more load shedding relays 260 may be controlled which allows the utility company to shut down power to areas having low usage priority in the event of a power outage or high usage times. For example, a customer may reach an agreement with the utility company to cut the power to his home during a "brown out" period such that the additional energy may be used to power a nearby hospital. The load shedding relay 260 is capable of being activated by the utility company over the network to the data collection device 120 because the GSM, PACS, FDMA, CDMA or TDMA communications link is capable of two-way communication. In addition, a power wheeling device may be attached to data collection device 120. The power wheeling device would allow the utility consumer to compare the utility rates of various utility companies in the area. If the consumer finds a more competitive utility rate, the consumer is capable of switching to that utility company by using the power wheeling device and the data collection device 120.

In one embodiment, the data collection device 120 is located in an extension to an existing electric meter, but the data collection device 120 may be housed and mounted in a separate waterproof unit. In either case, the data collection device 120 can be powered by an AC voltage obtained from the customer's utility power line. The AC voltage is

stepped down by power electronics 224 where, preferably, a voltage signal of about 8 volts is produced. A battery backup 226 is provided when the AC power source is not capable of providing power to the data collection device 120. Preferably, the battery backup 226 is a gel cell or similar battery having a long battery life. Also provided, with the data collection device 120, are security switches 228 that detect when the unit is tilted or when the cover to the unit is opened. When the security switches 228 are triggered, the data collection unit 210 is capable of reporting a security breach to the remote device 140, as shown in Fig 3, over the communications network.

When the data has been processed by the data collection unit 120, it is then sent over the network using GSM, PACS, FDMA, CDMA or TDMA communications electronics 234 that are connected to the data collection unit 210 and an antenna 242. The GSM, PACS, FDMA, CDMA or TDMA communications electronics 234 allows data to be transmitted to the data user's facility over the short message service or technical equivalent of a control channel of a GSM, PACS, FDMA, CDMA or TDMA network. As explained earlier, the communications connection over the network is a two-way link which allows data to be sent to and from the remote device or location and the data collection device 120. As such, the interested party may communicate with the data collection device 120 to access data or other features (e.g., load shedding and power utilizing).

Referring to Fig. 5, the data collection device can also be connected to a telecommunications system wiring at a user's location 248 (e.g., the existing telephone wiring in a house) to create a connection to a wireless telecommunications network, such as a GSM, PACS, FDMA, CDMA or a TDMA network. As such, as shown in Fig. 5, a vocoder 244 and ring/tone generator 246 located within the data

collection device 120 are connected to the existing telephone wiring 248. The ring/tone generator 246 is provided to create dial tone and ringing capabilities to the existing telephone wiring from the wireless telephone network. The vocoder 244 is used to convert voices to digital signals which are capable of being transmitted over the wireless network. This wireless telecommunications network connection replaces the need for wired telecommunications service because it established a wireless telecommunications interface at the location through the data collection device 120. In addition to providing wireless telephone service over the existing telephone wiring, the data collection device is capable of simultaneously performing all the functions described hereinabove.

In providing wireless telecommunications service through existing premise telephone wiring, the ring/tone generator is used as an interface to couple the existing premise wire-line telecommunications equipment/systems at that location with the wireless digital PCS telecommunications network. In Fig. 9, one embodiment of the telecommunications interface coupling 300 includes a wire-line telecommunications network 310 which comprises, for example, the existing wire based telecommunications circuitry within a building. The wire-line telecommunications equipment/system 310 is interconnected to the digital PCS wireless network 320 by the ring/tone generator 330. A data collection device 360 may also be connected to the ring-tone generator 330 in such a manner that the data collection device 360 is capable of transmitting, for example, utility usage data or other data over the digital PCS data collection device 360. In coupling the ring/tone generator 330 to the digital PCS network 320 data collection device 360, the ring/tone generator 330 is interconnected with the PCS

transmitter/receiver 340 that can be capable of digital transmission with at least one remote PCS transceiver base station 350. In the digital PCS wireless network 320, the remote PCS transceiver base stations 350 include base transmission stations, base station controllers and mobile switching centers as described herein above.

In another embodiment, the ring/tone generator 330, or system, has structures to accomplish several functions while providing the telecommunications interface coupling 300. These structures include means for converting data, means for determining the number of digits in a telephone number being dialed from the wire-line telecommunications network, means for generating a send signal to the PCS transmitter/receiver and means for interrogating and qualifying the dialed number before sending the telephone number dialed from the wire-line telecommunications network to the PCS transmitter/receiver.

The means for converting data includes any devices used to convert data. These devices include, but are not limited to, digital to analog converters and analog to digital converters and digital protocol converters. In the tone/ring generator, data that is collected by the data collection device must be converted to digital format before being sent to the PCS transmitter/receiver and transmitted over the digital PCS wireless network. Similarly, data or voice-tones input from the wire-line telecommunications network must also be converted to digital format before being sent over the digital PCS wireless network. Conversely, data or voice tones that must be input to the wire-line telecommunications network may have to be converted to analog format or other data formats, such as a data format that is compatible with a short message service (SMS) protocol of the particular digital PCS wireless network.

The means for determining the number of digits in a telephone number dialed from the wire-line telecommunications network includes any device capable of determining the number of digits dialed from a telecommunications network. In one embodiment, these devices may include electronic memory that is capable of storing a table of reference numbers. The electronic memory can be updated or changed by, for example, adding a new read-only memory device, reprogramming an existing writable-erasable memory device. The reprogramming of the memory device can be accomplished by sending data to the memory device over the wire-line telephone network or the PCS wireless network.

The reference numbers may have a lengths of 1 to 11 digits, and in a preferred embodiment the reference numbers have a length of 3 digits. The reference numbers stored in memory comprise area codes and local dialing prefixes that are recognized by the system. In addition, each of the stored reference numbers correlates to a specific number of digits to be dialed. Therefore, by analyzing, from 1 to 11 digits being dialed the system is able to determine how many digits will ultimately be dialed, and when the last digit is dialed the system can be instructed to take a specific action.

As the numbers are dialed from the wire-line telecommunications system, a converter can be used to convert the numbers from analog rotary or analog touch-tone signals to digital data. As the individual numbers are dialed, an electronic memory buffer sequentially stores the dialed numbers as digital data in a digital form. In addition, as the numbers are input, logic circuitry sequentially analyzes the dialed numbers to those stored reference number tables. As the numbers are analyzed and when the dialed numbers equal at least one stored reference number, the correlated length of telephone number digits to

be dialed may transmitted to the system. In response to the transmission of the length of the telephone number digits to be dialed, circuitry determines when the specified length of digits has been dialed by adding
5 subsequently dialed numbers to those dialed numbers already stored in memory.

For example, if the numbers 280 represented a local exchange prefix recognizable by the system, the number would be saved in a memory table as a reference number and
10 correlated with the number 7 because a local telephone number has a length of 7 digits. In operation, when the number 280 is sequentially dialed as the first three digits of a dialing stream, the numbers are stored and sequentially compared to the stored reference table
15 numbers. Once the logic circuitry determines that the dialed 280 matches a stored reference table number, the length of the telephone number digits (7) will be sent to the system. The logic circuitry determines that 3 numbers have already been dialed, those numbers being 2, 8 and 0,
20 and the system will wait until 4 more digits are dialed. Once the last digit has been dialed the system will be instructed to take the appropriate action which will include providing a "send" instruction to the PCS transceiver.

In another example, the numbers 1443 may represent a
25 long distance request (1) and an area code (443), and if the system recognized this number, the number would be stored in memory as a reference number. The reference number 1443 would be correlated to a telephone number
30 length of 11, including 1 + area code (3 digits) + prefix (3 digits) + user number (4 digits). In operation as the numbers are dialed, if 1443 is sequentially entered the logic circuit would transmit the telephone number length 11 to the system. The logic circuitry determines that 4
35 numbers have already been dialed, those numbers being 1, 4,

4 and 3, and the system will wait until 7 more digits are dialed. Once the last digit has been dialed the system will be instructed to take the appropriate action.

Typically, once the last digit has been dialed, the system retrieves the digitally stored dialed numbers and transmits these numbers along with a send signal to the PCS transmitter/receiver. The stored dialed number and send signal are sent to the PCS transmitter by any device that is capable of transmitting these commands. These devices include but are not limited to the described data collection device. Once the PCS transmitter/receiver receives the send signal and the telephone number, the information is transmitted over the PCS wireless network and the call is placed.

The memory table will also have the capability and will be programmed to recognize and transmit feature commands of feature controls specific to a particular personal communications system. These feature commands are the equivalent of feature commands found in use on wire-line telephone communications system, such as, but not limited to, *(star) 72, *(star)73 and hook flash.

It should be noted that, if a number is dialed that does not match or equal a stored reference number, the system will take no action and no information will be transmitted over the PCS wireless network. In addition, a send signal will only be generated by the system when the numbers dialed match one of the stored reference numbers from the table and the specified number of digits has been dialed (input). In another embodiment, the system may have a time-out device where a send signal will be generated and any stored numbers will be send to the PCS transmitter/receiver if a specified amount of time has elapsed since the last digit was dialed. In a preferred embodiment, the system will wait 30 seconds between dialed digits. This time-out feature may be implemented as a

substitute for the digit analysis or may be implemented when the dialed numbers do not match a stored reference number.

In another embodiment, the ring/tone generator, or
5 system, includes a ring signal generator that is capable of generating a ring signal to the premise wire-line telephone system from a call made on the PCS wireless network. The ring signal generator includes any device capable of generating a ring signal, including but not limited to a
10 power source capable of supplying a specified voltage to the wire-line telecommunications system when a telephone call is received from the PCS wireless network. In one embodiment, a ring signal can be generated by supplying 80 to 115 volts at 20 Hz. In addition, the ring/tone
15 generator may include a means for determining an off-hook condition. An off-hook condition includes, for example, a condition where a user lifts the receiver of the wire-line telecommunications equipment/system. Upon lifting the receiver, a dial-tone is generated by the wire-line
20 telecommunications equipment/system. Therefore, the off-hook condition can be any request by the wire-line equipment/system to generate a dial tone. The means for determining an off-hook condition includes any device that determines that a request for a dial tone has been made by
25 the wire-line telecommunications equipment/system.

In an embodiment of the present invention, as shown in Fig. 10 and as previously presented hereinabove, data can be collected by a data collection device 400 that transmits the data to the data collection device 400 and the data is
30 collected within the data collection device 400 and is output as cleartext. In one embodiment, the cleartext can be converted to digital format that will be sent as a short message over the PCS wireless network via the PCS transmitter/receiver 430. As explained hereinabove, the
35 converted data can be transmitted over the PCS wireless

network via the PCS transmitter/receiver 430 using the base transceiver stations (BTS) 400, the base station controller (BSC) 440 and the mobile switching center (MSC) 460. Ultimately, the data will be received by the remote receiving device (not shown). The transmission scheme presented above transmits data exclusively using the digital PCS wireless network. In regions that do not have access to a PCS wireless network, data collected at the data collection device may be transmitted using the existing wire-line telecommunications network, such as a public or privately switched telephone network (PSTN), using an out of band modem.

Also shown in Fig. 10, it should be appreciated that a request for data 490 can be sent to the data collection device via the PSTN 480 over the PCS wireless network. The request for data 490 is in cleartext format allowing the data to be sent as a short message (SM) over the PCS wireless network. The cleartext data is sent via a PSTN 480 to the mobile switching center (MSC) 460 and then to the short message center 470 which converts the cleartext data into a short message (SM) and routes the SM to the base station controller (BSC) 440, the remote base transceiver station (BTS) 450 and the PCS transmitter/receiver 430. The SM is received in cleartext format recognized by the data collection device 400. The data collection device 400 can respond to the request for data 490.

In another embodiment shown in Fig. 10, data is collected by a data collection device 400. The data is transmitted in cleartext to a PCS wireless network as a short message (SM). Typically, the short message service (SMS) of a PCS wireless network allows 140 to 160 character per message to be sent. In one embodiment, the data collection device 400 divides the data into packets having a character length of 140 to 160 characters. As mentioned

above, a request for data or other information may be sent to the data collection device 400 using the PSTN 480.

The data from the data collection device 400 is transmitted to an out of band modem 420 that is connected
5 to a PSTN 480. The out of band modem 420 modulates the converted data over a specific frequency bandwidth and transmits that data via the PSTN 480 to the mobile switching center (MSC) 460. The converted data is recognized as a short message (SM) by the MSC 460 and the
10 converted data is sent to the short message service (SMS) 470 of the PCS wireless network. From the SMS 470, the short message (SM), comprising the converted data, is transmitted to a remote receiving device (not shown). For requests for data or information sent to the data
15 collection device 400 over the PSTN 480, this information can also be sent to the out of band modem 420 that is connected to the PSTN 480.

In one embodiment, as shown in Fig. 11, the out of band modem 420 modulates data sent from the data collection
20 device 400 to the PSTN 480, using modulator 510, and demodulates data sent to the data collection device 400 from the PSTN 480, using demodulator 500. In one embodiment, the data is modulated over a bandwidth of 600 Hertz (Hz). In a preferred embodiment, the data is
25 modulated over the bandwidth of about 3200 to 3800 Hz. Typically, on a PSTN the voice bandwidth, theoretically, ranges from about 30 to 4000 Hz but, in practice, the bandwidth used to transmit voice data is about 300 to 34000 Hz. Therefore, the bandwidth on which the out of band
30 modem operates, about 3200 to 3800 Hz, is considered out of band because this bandwidth is, typically, not used by a user of the PSTN during voice transmission. As such, use of this bandwidth to send data over the PSTN would be 'transparent' to the user of the PSTN.

To ensure that the data being sent to and from the data collection device 400 is over this bandwidth, lowpass filters 530 and 540 are used. In a preferred embodiment, low pass filters 530 and 540 remove any transmitted data that is transmitted at a frequency that is lower than 3000 Hz. In addition, in the embodiment shown in Fig. 11, the user that uses the PSTN to user interface 560 may use a lockout control 550. Inductive coils 520 couple the D.C. loop current allowing normal use of the wire-line telecommunications equipment/system which use is not interrupted or affected during transfers of data involving the out of band modem.

Additionally, a method for collecting and transmitting data from the data collection device 120 is provided. First, analog and digital data is sensed at a first location. The analog data is subsequently converted into digital data. The digital data is processed into a desired format and is stored in a memory device. The processed digital data is transmitted over a wireless network to a remote device or location. In another embodiment, the transmission step is made over a wireless network control channel or short message service using GSM, PACS, FDMA, CDMA or TDMA digital technology.

In another embodiment, the data from the optical meter reader microprocessor 340 may be wirelessly transmitted to the data collection device over an unlicensed radio frequency band. As explained earlier, the data can be transmitted from the reader 300 to the data collection device using an LC or SAW transmitter circuit.

Additionally, a method is provided for monitoring utility usage data from a conventional utility meter having a rotatable disk. First, a beam of radiation is transmitted from a source and reflected off of the reflecting device to the rotatable disk. The beam is then reflected again off the rotatable disk back to the

reflecting device where it is reflected toward an infrared detector and detected. The number of rotations of the disk is calculated from the number of times that the detector detects the infrared beam of light. The reader contains
5 algorithms to prevent false readings caused by sunlight, other forms of optical interference or reverse meter rotation.

In another embodiment, a method for transmitting a data sequence via a personal communications personal
10 communications system transmission protocol is disclosed. As discussed above, the personal communications system transmission protocol includes several standards of operation. These standards include a global system for mobile communications (GSM) technology network, a time
15 division multiple access (TDMA) technology network or a code division multiple access (CDMA) technology network, frequency division multiple access (FDMA) technology network and personal access communications system (PACS) technology network, among others. Each of these technology
20 networks employ the use of a type of digital control channel to direct communications to the correct location. Typically, the control channel is used to transmit a sequence of data that is used to direct voice or data communications to the correct destination via a personal
25 communications system.

The short message service normally occupies a portion of the control channel and is used as an additional data path by the data collection device on the network. A detailed discussion of the GSM and PCS transmission protocols e.g.,
30 can be found in the publication "An Introduction to GSM" by Michel Mouly and Marie-Bernadette Pautet published in 1993 by Northern Telecom, Inc. of Richardson, Texas.

A previous embodiment described the use of the digital control channel to transmit data from one device to another
35 using a drop and add packet technique. The present

embodiment employs the use of the short message portion of the personal communications system transmission protocol to transmit data from one device to another. Generally, the short message service portion of the personal communications system transmission protocol is a means to send a protocol specific number of characters of data to, from and between mobile subscribers (MS), i.e. a device capable of transmitting via the personal communications system. Another difference between the use of the voice control channel and short message service is that the short message service performs at a lower frequency of data packets within the control channel because of the specifics of the short message service operating protocol employed by the various technologies. For example, using the voice control channel, data could be transmitted to the data collection device to the remote device at 275 to 325 data groups per second and the data collection device can respond and send data groups at the same (or similar) rate depending upon control channel traffic loading. In the case of the short message service, data is transmitted at about 7 data groups per second.

In the present invention, data is requested and the requested data is sent using the short message service portion of the personal communications system transmission protocol. As mentioned above, the short message service portion of the personal communications system transmission protocol is a means to send a protocol specific number of characters of data to and from a mobile subscriber (MS). In one embodiment, as shown in Fig. 8, the data collection device 50 appears on the communications network as a mobile subscriber and the remote device 54 has the capability of contacting the data collection device using the personal communications system network 52. The remote device 54 may be accessed through the public switched telephone network 56. Additionally, the connection of the remote device to

a public switched telephone network 56 allows data to be sent to and from the remote device 54 via the public switched telephone network 56. For example, when a utility company is interested in receiving meter usage data from its customers, the utility company may connect via the public switched telephone network 56 to data collection device 50 using the remote device 54. The remote device 54 requests the data from the data collection device 50, and when the data is received by the remote device 54, it is transmitted to the utility company or a data collection center via the public switched telephone network 56 using a modem, for example.

When a request for data is made, the remote device 54 encodes the request as a short message according to the personal communications system transmission protocol. The data may be assembled into the short message sequence using various known techniques. In Fig. 7, one technique for assembling a short message service GSM control channel data sequence is shown. The control channel, in Fig. 7, illustrates an downlink portion 10 and a uplink portion 12 of the control channel. In another embodiment, the control channel can include a stand-alone dedicated control channel (SDCCH) and/or a slow associated control channel (SACCH). As noted above, a detailed discussion of the GSM and PCS transmission protocols can be found in the publication "An Introduction to GSM" by Michel Mouly and Marie-Bernadette Pautet published in 1993 by Northern Telecom, Inc. of Richardson, Texas. The control channel contains a protocol specific number of characters per packet. Each of the packets has a specific significance in the protocol. In Fig. 7, data character units 34 and 36 may be used to transmit an intended short message from a remote device to a mobile subscriber. The present invention is capable of interpreting requests sent in the data character units 34 and 36 as a short message. In addition, the present

invention is capable of composing short messages that contain the requested data. In composing the short message, the present invention may insert a send requested in the data. After the data is added as a short message, the data is transmitted from the data collection device (50) to the remote device (54) to the mobile subscriber and from the mobile subscriber to the remote device (54) to the data collection device (50). As mentioned above, techniques of assembling, sending, receiving and interpreting short message type service may be use to accommodate other technologies.

The request for data is made by the remote device 54 and converted to short message service format, this request is transmitted using a wireless personal communications system network 52. The short message service data sequence is received at a base station controller (BSC) 60 which identifies the data as a short message. The BSC 60 transmits the short message using the mobile switching center (G/MSC/VLR) 62 to the short message center (SMS-C) 58. The request for data is then transmitted from the SMS-C 58 to the data collection device 50 through the G/MSC/VLR and BSC, using the wireless personal communications system network 52. The data collection device 50 responds to the request for data by interpreting the request and compiling the data that was requested. The compiled data is transmitted by the data collection device 50 using the short message service of the personal communications system transmission protocol. Similar to the request for data, the compiled data is inserted into the control channel or other data sequences as a short message. It should be appreciated that the data may be sent using multiple short messages in several control channel or other data sequences. The control data sequence is then transmitted as a short message using the wireless personal communications system network 52 using the BSC 60 and the

G/MSC/VLR 62. During this transmission, the BSC 60 identifies the control channel data sequence as a short message and the sequence is sent to the SMS-C 58. The compiled data is then sent as a short message to the remote
5 device 54 using the wireless personal communications system network 52. The remote device 54 receives and interprets the compiled data. As stated earlier, the assembly and disassembly of the request for data and the transmission packets in the control channel or other data sequence may
10 be made using data packet assembly and disassembly techniques or standard short message service protocol technology.

Although the following disclosure has described the remote device 54 requesting data from the data collection
15 device 50, it should be noted that the data collection device 50 may send data to the remote device 54 without being, first, prompted to send data. For example, the data collection device 50 may embody a security device in a home. Once a security breach is detected by the data
20 collection device 50, this breach may be set via the short message service portion of the personal communications system transmission protocol to the remote device 54, using the above described method. Once the security breach is received by the remote device 54, further security
25 precautions may be made, such as notifying law enforcement personnel.

In another embodiment as shown in Fig. 6, the data collection device 101 includes a device for data stamping the collected data. The date/time stamp device 108 is an
30 electronic device that provides a time relationship to the collected data. As the data is retrieved from the meter or devices 100, the date/time stamp device 108 electronically assigns each data reading with the date/time that the data was collected. The collected data and its associated time
35 stamp are capable of being stored in a data collection

device, such as electronic memory, for later retrieval. As such, the saved data that is retrieved at a later time may be useful to develop usage profiles that reflect the amount and time the data was used or compiled and stored. This
5 type of usage profiling is beneficial when compiling power consumption data from a home or business.

In addition, the date/time stamp device 108 may be capable of adjusting data collection parameters such as the frequency of collection, related time stamp and
10 notification of consumption. For example, the remote device 140 can instruct the data collection device 101 to collect data on an hourly interval and time/date stamp each reading when it is acquired. In addition, the remove device 140 can instruct the data collection device to
15 terminate all power being supplied to a location if a predetermined consumption level is reached or in the case of load shedding, on a pre-determined basis through agreement with the utility company and the utility consumer, simply terminate power to non-essential energy
20 consuming devices.

The data collection device 101 may also include a short message controller 109. The short message controller 109 is capable of interpreting a short message received from the remote device 140. The short message controller
25 109 is also capable of instructing the data collection device 101 to perform several data collection functions, such as to collect data and retrieve saved data. Once the data collection device 101 has performed the desired function, the short message controller 109 is capable of
30 composing a short message that contains the requested data. The composed short message composed by the short message controller 109 is capable of being sent over the short message service portion of the personal communications system transmission protocol.

The foregoing discussion of the invention has been presented for purposes of illustration and description. Further, the description is not intended to limit the invention to the form disclosed herein. Consequently, 5 variations and modifications commensurate with the above teachings, with the skill and knowledge of the relevant art, are within the scope of the present invention. The embodiment described hereinabove is further intended to explain the best mode presently known of practicing the 10 invention and to enable others skilled in the art to utilize the invention as such, or in other embodiments, and with the various modifications required by their particular application or uses of the invention. It is intended that the appended claims be construed to include alternative 15 embodiments to the extent permitted by the prior art.

What is claimed is:

1. An apparatus for sensing and digitally transmitting data via a wireless network comprising:

(a) means for sensing analog and/or digital data at a first location;

(b) means for converting said analog data from said sensing means to converted digital data;

(c) means for processing and storing said sensed and/or converted digital data received from said means for sensing and said means for converting; and

(d) means for wirelessly transmitting and receiving digital data being capable of transmitting digital data received from said means for processing and storing;

wherein the digital data is transmitted to a remote device in response to an apparatus-specific command received from the remote device specific to said apparatus.

2. An apparatus, as claimed in Claim 1, wherein said steps of first transmitting and second transmitting uses the personal communications system transmission protocol of a network selected from the group consisting of a global system for mobility (GSM) technology network, a time division multiple access (TDMA) technology network, frequency division multiple access technology network (FDMA), personal access communications system technology network (PACS) or a code division multiple access (CDMA) technology network.

3. An apparatus, as claimed in Claim 1, wherein the digital data is transmitted to the remote device using a control channel or technical equivalent of said wireless network.

4. An apparatus, as claimed in Claim 1, wherein said means for sensing data further comprises:

a sensor unit for sensing data; and

an intermediate wireless transmitting unit for wirelessly transmitting sensed data to said means for processing and storing.

5 5. An apparatus, as claimed in Claim 1, wherein said means for computing and storing further comprises:

a central processing unit for processing said digital data;

10 an erasable, programmable read-only memory unit electronically connected to said central processing unit for storing an algorithm used to process said sensed and converted digital data;

a random access memory unit connected to said central processing unit and said erasable, programmable read-only memory unit for storing said processed digital data.

15 6. An apparatus, as claimed in Claim 1, further comprising a connective interface for connecting existing telecommunications system at the first location to said means for wirelessly transmitting data, wherein a wireless telecommunications connection capable of at least one of
20 voice and data transmission is created.

7. A method for sensing and digitally transmitting data via a wireless network comprising the steps of:

(a) sensing analog and/or digital data at a first location;

25 (b) converting the sensed analog data to digital data;

(c) processing the digital data;

(d) storing the processed digital data; and

30 (e) transmitting the digital data over a wireless network to a remote device, wherein the digital data is transmitted to the remote device in response to an apparatus-specific command received from the remote device.

8. The method, as claimed in Claim 7, wherein the step of transmitting transmits digital data using a control channel of said cellular network.

9. The method, as claimed in Claim 7, wherein said
5 cellular network is selected from the group consisting of a GSM technology network or a TDMA technology network.

10. An apparatus for monitoring utility usage data from an existing conventional utility meter having a reflective device, said apparatus comprising:

10 means for transmitting radiation;
means for receiving the transmitted radiation;
means for reflecting the transmitted radiation located between said means for transmitting and said means for receiving, wherein said means for reflecting optically
15 connects said means for transmitting, said means for receiving and the reflective device;

means for calculating a number of rotations of the reflective device from the reflected radiation;

20 means for processing the number of rotations of the reflective device into utility usage data;

means for electronically storing the utility usage data; and

means for transmitting the utility usage data to a remote device.

25 11. The apparatus, as claimed in Claim 10, wherein the utility usage data is wirelessly transmitted.

12. The apparatus, as claimed in Claim 11, wherein the utility usage data is transmitted over an unlicensed frequency.

30 13. The apparatus, as claimed in Claim 10, wherein said means for reflecting comprises two mirrors.

14. The apparatus, as claimed in Claim 10, further comprising a display monitor for visually displaying the utility/usage data to an observer.

15. An apparatus as claimed in Claim 10, wherein the reflective device is selected from the group consisting of a rotatable disk, a rotating dial or a mechanical indicator.

5 16. The apparatus, as claimed in Claim 10, wherein said means for transmitting the utility usage data to a remote device comprises:

10 a first transmitter electrically connected to said apparatus, said first transmitter capable of wirelessly transmitting the utility usage data over an unlicensed radio frequency to a second means for wirelessly transmitting digital data, wherein said second means for wirelessly transmitting digital data is remotely located from said apparatus;

15 an inductive/capacitive super regenerative receiver electrically connected to said second means for wirelessly transmitting digital data, said receiver being capable of receiving data transmitted by said first transmitter over the unlicensed radio frequency; and

20 said second means for wirelessly transmitting digital data being capable of wirelessly transmitting the utility usage data over a wireless network to the remote device.

25 17. A method for monitoring utility usage data from an existing conventional utility meter having a reflective device, the method comprising the steps of:

(a) emitting an infrared beam of radiation from a source;

(b) reflecting the beam from a means for reflecting to the reflective device;

30 (c) reflecting the beam from the reflective device to the means for reflecting;

(d) reflecting the beam from the means for reflecting to a detector;

(e) detecting the beam; and

(f) calculating the number of rotations of reflective device based on the number of times the beam is interrupted.

18. A method as claimed in Claim 17, wherein the
5 reflective device is selected from the group consisting of a rotatable disk, a rotating dial or a mechanical indicator.

19. A method for transmitting a data sequence via a personal communications system transmission protocol
10 comprising the steps of:

first transmitting a request for data from an access point to a data collection unit via a short message service portion of the personal communications system transmission protocol;

15 receiving said request for data at said data collection unit;

interpreting said request for data from said access point by said data collection unit;

20 compiling data from said data collection unit, said data being requested in said request for data;

second transmitting said compiled data from said data collection unit to said access point via said short message service portion of the control channel of the personal communications system transmission protocol; and

25 receiving said compiled data at said access point.

20. The method, according to Claim 19, wherein said step of first transmitting comprises the steps of:

30 first accessing said short message service portion of said control channel of the personal communications system transmission protocol from said access point, said control channel containing a first sequence of short message service transmission packets;

inserting said request for data into said control channel of the short message service portion of said

personal communications system transmission protocol as a short message;

creating a second sequence of short message service transmission packets using said inserting step;

5 transmitting said second sequence of short message service transmission packets to said data collection unit from said access point via said short message service portion of said control channel of the personal communications system transmission protocol.

10 21. The method, according to Claim 19, wherein said step of receiving said request comprising the step of:

receiving said second sequence of short message service transmission packets in said control channel at said data collection unit from said transmitting said second sequence step.

22. The method, according to Claim 19, wherein said step of interpreting comprising the step of:

15 interpreting said request for data from said second sequence of short message service transmission packets.

23. The method, according to Claim 19, wherein said step of second transmitting comprising the steps of:

25 second accessing short message service portion of a control channel of the personal communications system transmission protocol from said data collection unit, wherein said short message service data comprises a third sequence of short message service transmission packets;

30 inserting said compiled data from said compiling step into said short message service transmission packets of said third sequence;

creating a fourth sequence of short message service transmission packets using said inserting step;

35 transmitting said fourth sequence of short message service transmission packets to said access point from said access point via said short message service

portion of said control channel of the personal communications system transmission protocol.

24. The method, according to Claim 19, wherein said steps of first transmitting and second transmitting uses
5 the personal communications system transmission protocol of a network selected from the group consisting of a global system for mobility (GSM) technology network, a time division multiple access (TDMA) technology network, frequency division multiple access technology network
10 (FDMA), personal access communications system technology network (PACS) or a code division multiple access (CDMA) technology network.

25. The method, according to Claim 19, wherein said first transmitting and said second transmitting steps
15 transmit over a stand-alone dedicated control channel (SDCCH) of said short message service portion of the personal communications system transmission protocol.

26. The method, according to Claim 19, wherein said first transmitting and second transmitting transmit over a
20 slow associated control channel (SACCH) of said short message service portion of the personal communications system transmission protocol.

27. The method, according to Claim 19, further comprising the steps of:

25 sensing analog and/or digital data at a first location;

converting the sensed analog data to digital data; and processing the digital data and the data converted by said converting step.

30 28. The method, according to Claim 19, further comprising the steps of:

collecting data at said data collection unit;
electronically stamping said collected data with a date and time that said data was collected by said
35 collecting step; and

storing said processed and electronically stamped data.

29. The method, according to Claim 19, further comprising the steps of:

5 composing at least one short message from said compiled data at said data collection unit; and

 inserting said at least one short message in the short message service portion of the control channel of the personal communications system transmission protocol.

10 30. A method for transmitting a data sequence via a personal communications system transmission protocol comprising the steps of:

 first accessing said short message service portion of said control channel of the personal communications system transmission protocol from said access point, said control channel containing a first sequence of short message service transmission packets;

15 inserting said request for data into said control channel of the short message service portion of said personal communications system transmission protocol as a short message;

 creating a second sequence of short message service transmission packets using said inserting step;

20 transmitting said second sequence of short message service transmission packets to said data collection unit from said access point via said short message service portion of said control channel of the personal communications system transmission protocol;

25 receiving said second sequence of short message service transmission packets in said control channel at said data collection unit from said transmitting said second sequence step;

30 interpreting said request for data from said second sequence of short message service transmission packets;

compiling data from said data collection unit, said data being requested in said request for data;

second accessing short message service portion of a control channel of the personal communications system transmission protocol from said data collection unit,
5 wherein said short message service data comprises a third sequence of short message service transmission packets;

inserting said compiled data from said compiling step into said short message service transmission packets of
10 said third sequence;

creating a fourth sequence of short message service transmission packets using said inserting step;

transmitting said fourth sequence of short message service transmission packets to said access point from said
15 access point via said short message service portion of said control channel of the personal communications system transmission protocol.

31. A method for transmitting a data sequence via a personal communications system transmission protocol
20 comprising the steps of:

collecting data at a data collection unit;

composing at least one short message from said collected data;

inserting said at least one short message in a control
25 channel via a short message service portion of the personal communications system transmission protocol; and

transmitting said control channel including said at least one short message to an access point via said short message service portion of the personal communications
30 system transmission protocol.

32. The method, according to Claim 31, further including the steps of:

stamping said collected data with a date and time that said data was collected by said collecting step.

33. The method, according to Claim 31, wherein the step of transmitting uses the personal communications system transmission protocol of a network selected from the group consisting of a global system for mobility (GSM) technology network, a time division multiple access (TDMA) technology network, a code division multiple access (CDMA) technology network, frequency division multiple access technology network (FDMA) or personal access communications system technology network (PACS).

34. The method, according to Claim 31, further comprising the step of:

receiving said control channel including said at least one short message at said access point; and

interpreting said control channel including said at least one short message at said access point.

35. An apparatus for collecting and digitally transmitting a data sequence via a personal communications system transmission system protocol, said apparatus comprising:

means for electronically collecting data at a first location;

means for composing at least one short messages from said electronically collected data;

means for inserting said composed short message in a control channel of a short message service portion of the personal communications system transmission protocol; and

means for transmitting said control signal including said at least one short message to an access point via said short message service portion of said personal communications system transmission protocol.

36. The apparatus, according to Claim 35, further comprising:

means for time and date stamping said collected data within a time and date that the data was collected.

37. The apparatus, according to Claim 35, further comprising:

means for storing said collected data for subsequent transmission to an access point.

5 38. The apparatus, according to Claim 35, wherein said means for transmitting uses the personal communications system transmission protocol of a network selected from the group consisting of a global system for mobility (GSM) technology network, a time division multiple
10 access (TDMA) technology network, a code division multiple access (CDMA) technology network, frequency division multiple access technology network (FDMA) or personal access communications system technology network (PACS).

15 39. The apparatus, according to Claim 35, further comprising:

means for receiving a short message from said access point, wherein said short message is transmitted control channel signal of said short message service portion of said personal communications system transmission protocol;
20 and

means for interpreting said short message from said access point into a command executable by said apparatus.

40. A device for coupling wire-line telecommunications equipment/systems and a digital personal
25 communications system (PCS) radio receiver/transmitter used in a wireless digital PCS telecommunications network, the wireless digital PCS telecommunications network having a remote digital PCS transceiver system; the PCS digital radio receiver/transmitter being capable of digital radio
30 communication with the remote digital PCS transceiver system, said device comprising:

a wire-line telecommunications equipment/systems interface connecting said device with said wire-line telecommunications equipment/systems creating a first two-
35 way communications link;

first means for converting data, said data being input to said wire-line telecommunications equipment/systems from said device;

5 a digital PCS radio receiver/transmitter interface connecting said device with said digital PCS radio receiver/transmitter creating a second two-way communications link;

10 second means for converting data, said data being input to said digital PCS radio transmitter/receiver from said device;

means for determining a number of telephone number digits being dialed from said wire-line telecommunications equipment/systems, said number of telephone digits are capable of being input to said wire-line telecommunications equipment/system by a user, said means for determining comprising:

20 first means for receiving, storing and converting to digital status a plurality of digits in electronic memory, said stored digits comprising a telephonic number dialing sequence having a length capable of placing, dialing or accessing said wire-line telecommunications equipment/systems, wherein each of said stored numbers is represented by a specific number of digits to be dialed which have been input through the wire-line
25 telecommunications equipment/systems by a service user;

second means for storing dialed telephone digits, said dialed telephone digits being input from said wire-line telecommunications equipment/systems;

30 means for sequentially analyzing at least a portion of said dialed telephone digits to said stored numbers, said digits being analyzed until said dialed telephone digits are equal to at least one of said stored number criteria, recognizing number input as previously categorized;

means for generating a send signal to said digital PCS radio transmitter/receiver, wherein said send signal is generated after said specified number of digits corresponding to said at least one stored number is dialed;
5 and

means for sending said stored dialed telephone number digits to said digital PCS radio transmitter/receiver, wherein said stored dialed telephone number digits are sent after said specified number of digits corresponding to said
10 at least one stored number is dialed.

41. The device, according to Claim 40, further comprising:

means for generating a ring signal to said wire-line telecommunications equipment/systems, wherein said ring
15 signal is generated when a telephone call is made to said wire-line telecommunications equipment/systems over the wireless digital PCS telecommunications network; and

means for acknowledging a first status and connecting said wireless digital PCS telecommunications network to
20 said wire-line telecommunications equipment/systems, said first status being an off-hook condition on said wire-line equipment/system.

42. The device, according to Claim 40, wherein a data collection device is interconnected with said device, said
25 data collection device being capable of transmitting data to said device.

43. A method for coupling wire-line telecommunications equipment/systems and a digital personal communications system (PCS) radio receiver/transmitter used
30 in a wireless digital PCS telecommunications network, the wireless digital PCS telecommunications network having a remote digital PCS transceiver system; the PCS digital radio receiver/transmitter being capable of digital radio communication with the remote digital PCS transceiver
35 system, said method comprising the steps of:

connecting wire-line telecommunications equipment/
systems with a device creating a first two-way
communications link;

5 first converting data, said data being input to said
wire-line telecommunications system from said device;

connecting a digital PCS radio receiver/transmitter
with said device creating a second two-way communications
link;

10 second converting data, said data being input to said
digital PCS radio transmitter/receiver from said device;

determining a number of telephone number digits being
dialed from said wire-line telecommunications
equipment/systems, said number of telephone digits are
capable of being input to said wire-line telephone service
15 by a user, said step of determining comprising the steps
of:

first storing a plurality of numbers in
electronic memory, said stored numbers having a length of
at least three digits, wherein each of said stored numbers
20 is represented by a specific number of digits to be dialed;

second storing dialed telephone digits, said
dialed telephone digits being input from said wire-line
telecommunications equipment/systems;

25 sequentially analyzing at least a portion of said
dialed telephone digits to said stored numbers, said digits
being analyzed until said dialed telephone digits are equal
to at least one of said stored numbers;

generating a send signal to said digital PCS radio
transmitter/receiver, wherein said send signal is generated
30 after said specified number of digits corresponding to said
at least one stored numbers is dialed; and

sending said dialed telephone digits to said digital
PCS radio transmitter/receiver, wherein said dialed
telephone digits are sent after said specified number of

digits corresponding to said at least one stored number is dialed.

44. The method, according to Claim 43, further comprising the steps of:

5 generating a ring signal to said wire-line telecommunications system, wherein said ring signal is generated when a telephone call is made to said wire-line telecommunications equipment/system over the wireless digital PCS telecommunications network; and

10 completing a coupling of said wire-line telecommunications equipment/systems and said wireless digital PCS network upon recognition a first state; said first state being an off-hook condition on said wire-line telecommunications equipment/system.

15 45. The method, according to Claim 43, further comprising the step of:

interconnecting a data collection device with said device, said data collection device being capable of transmitting data to said device.

20 46. A device for transmitting and receiving data, said data being conveyed over a telecommunications network, said device comprising:

first means for converting data sent over said telecommunications network, said data being converted to be

25 compatible with a personal communications network (PCS) short message service (SMS) transmission protocol;

means for modulating said data sent over said telecommunications network, said data being modulated over a bandwidth;

30 second means for converting data received from said telecommunications network; and

means for demodulating said data received from said telecommunications network, said data being demodulated from said bandwidth.

47. The device, according to Claim 46, wherein said bandwidth ranges from about 3200 to 3800 Hz.

48. The device, according to Claims 46, wherein the personal communications system (PCS) short message service
5 (SMS) transmission protocol is selected from the group consisting of a global system for mobility (GSM) technology network, a time division multiple access (TDMA) technology network, a code division multiple access (CDMA) technology network, frequency division multiple access technology
10 network (FDMA) or personal access communications system technology network (PACS).

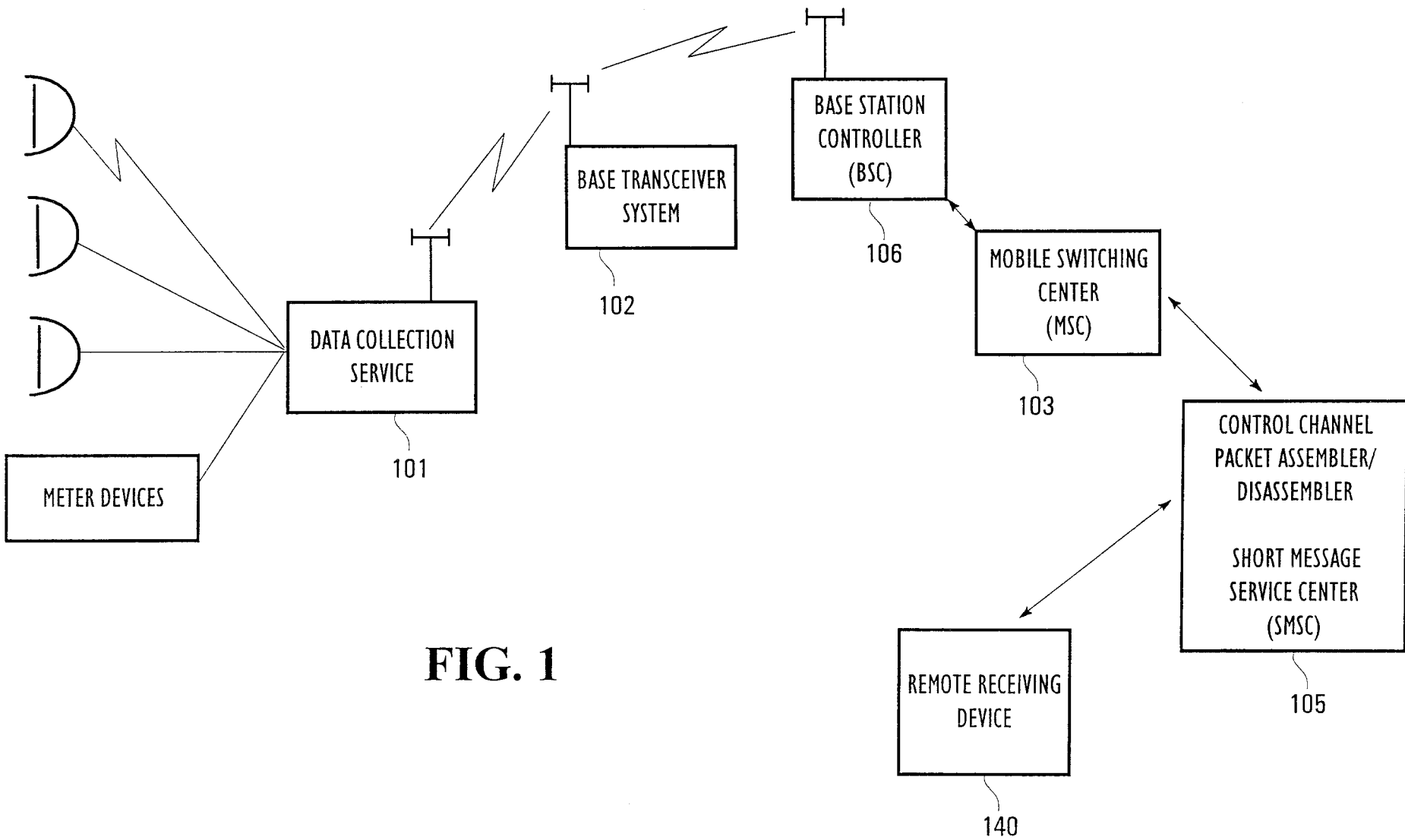

FIG. 1

1/11

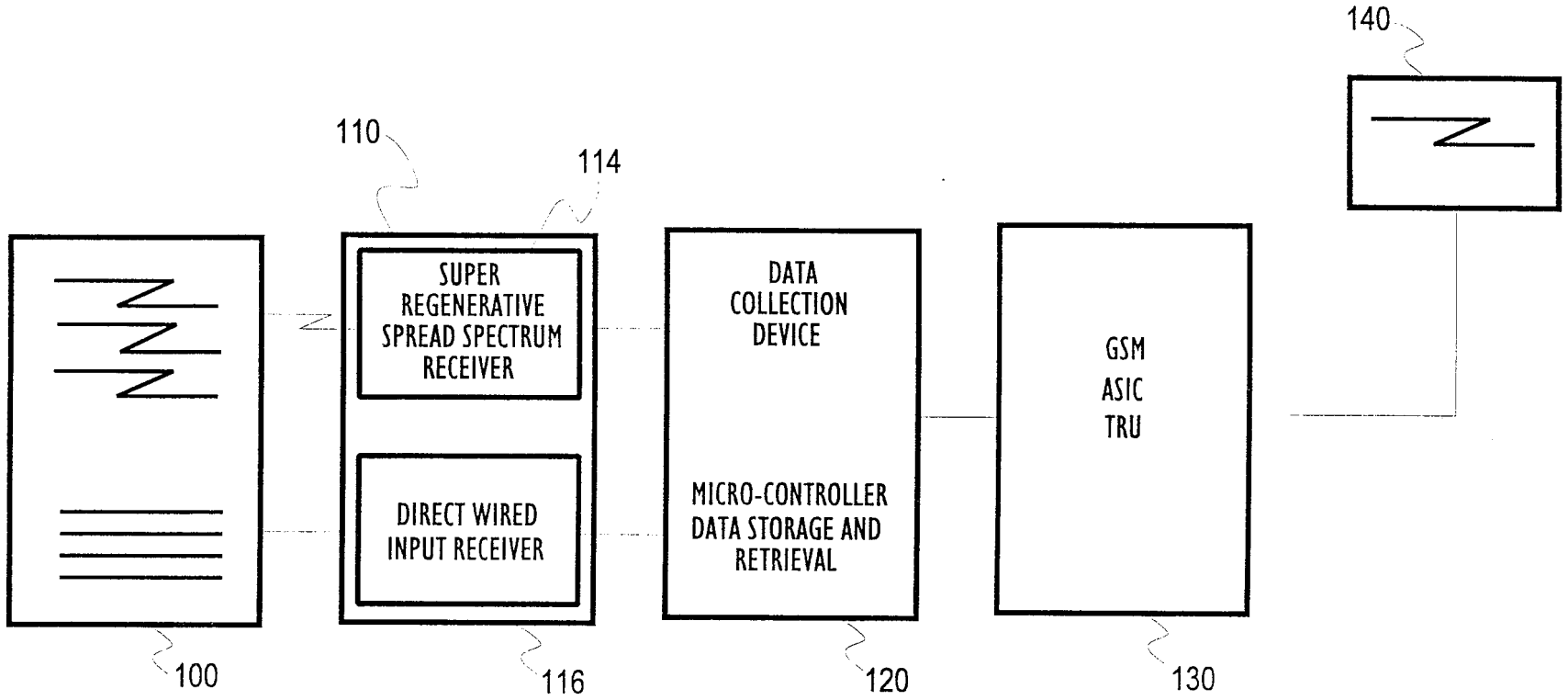

FIG. 2

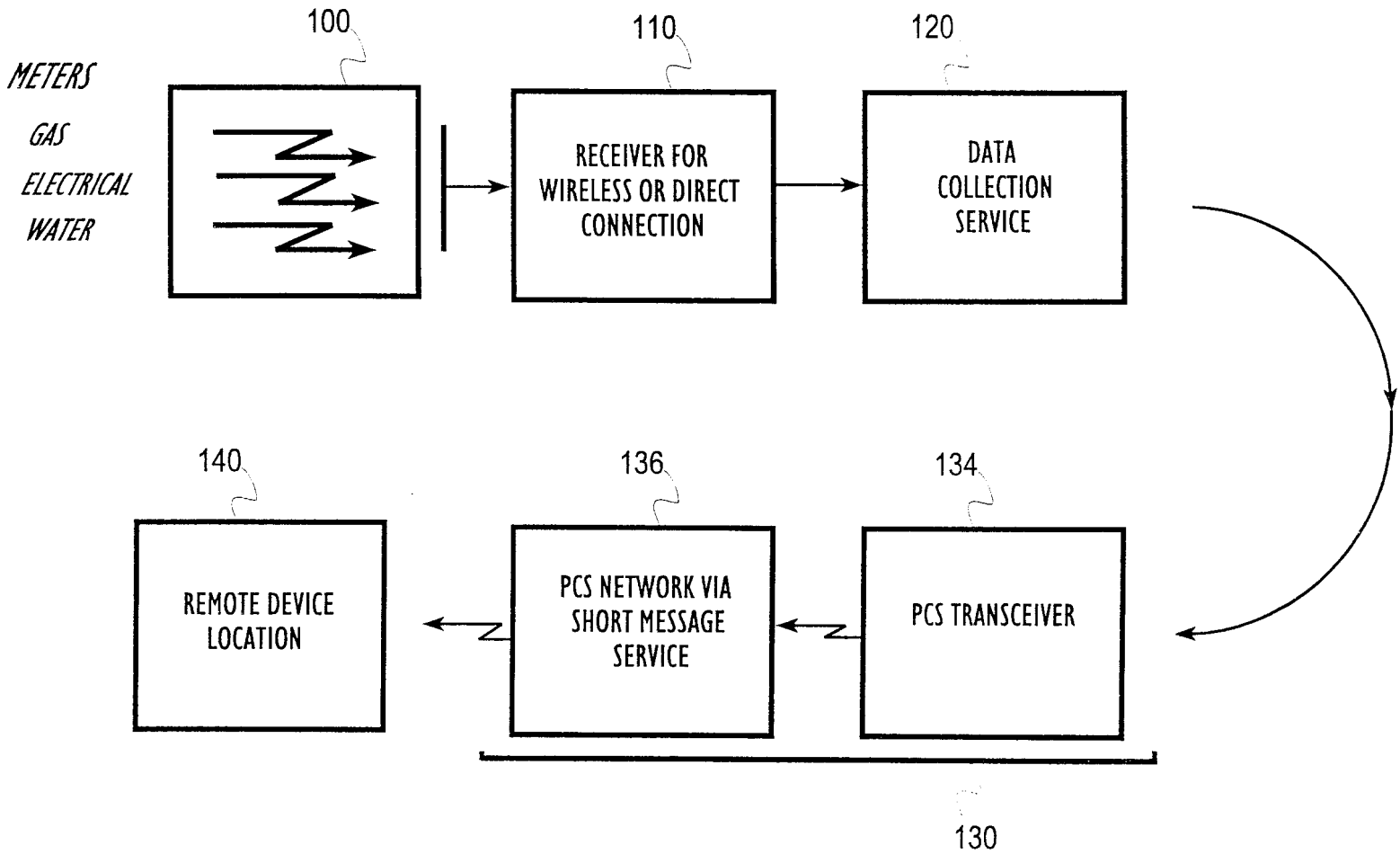
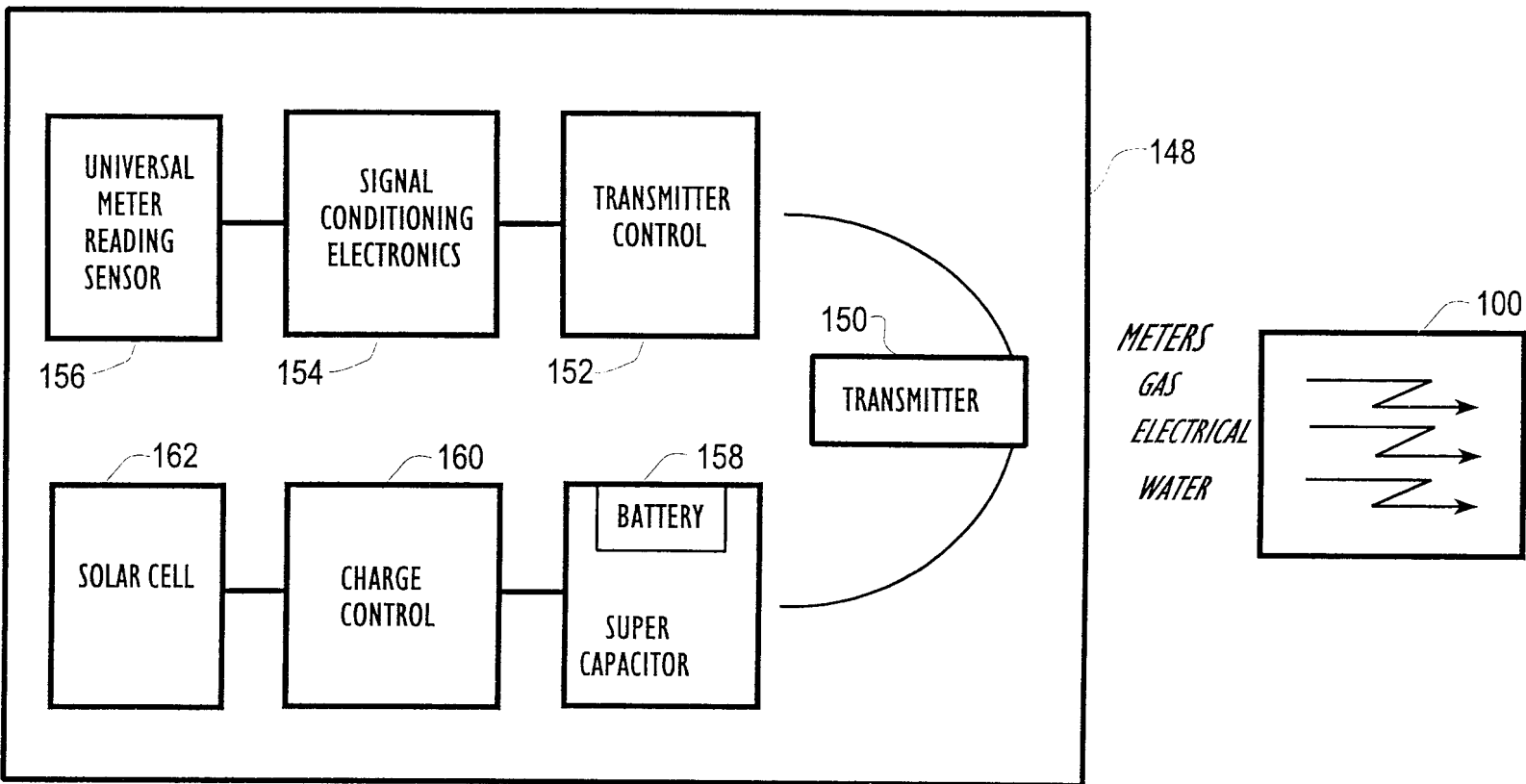

FIG. 3



SUBSTITUTE SHEET (RULE 26)

FIG. 4

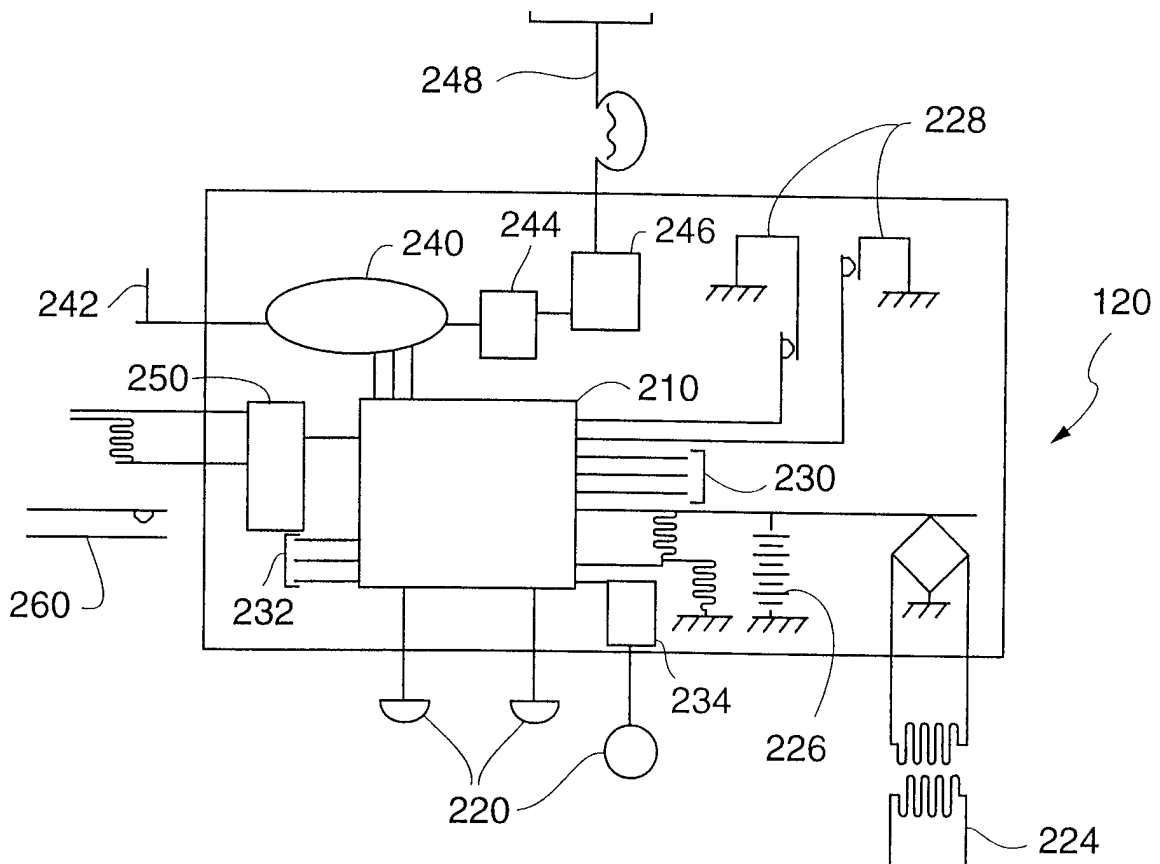

Fig. 5

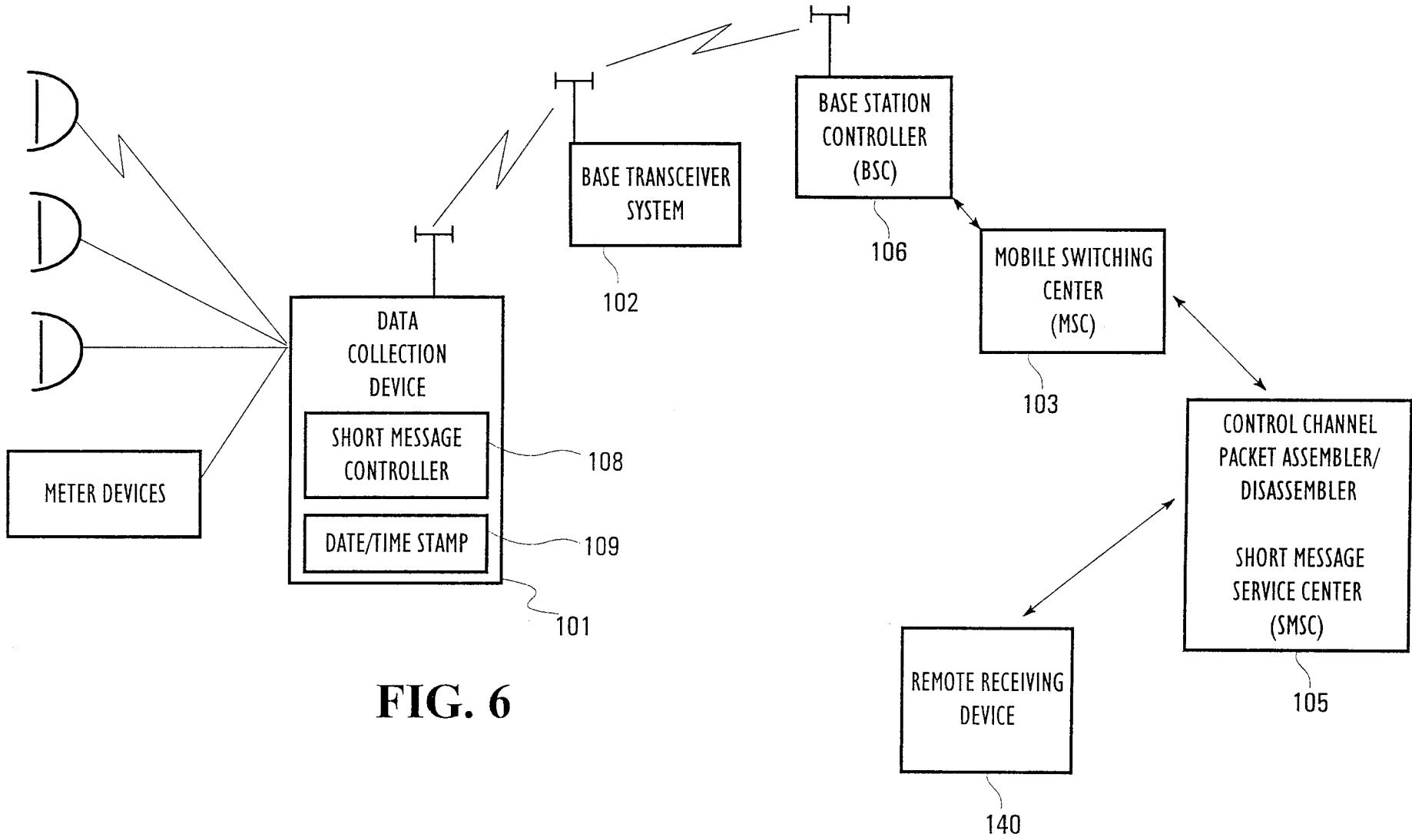

FIG. 6

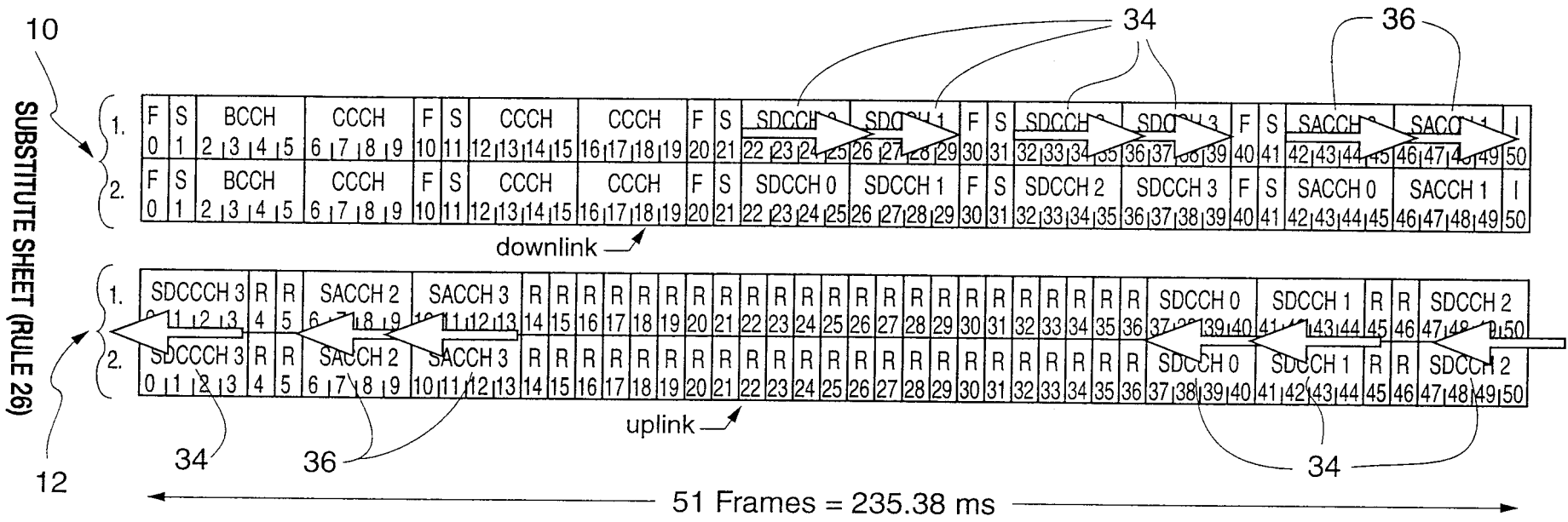

Fig. 7

7/11

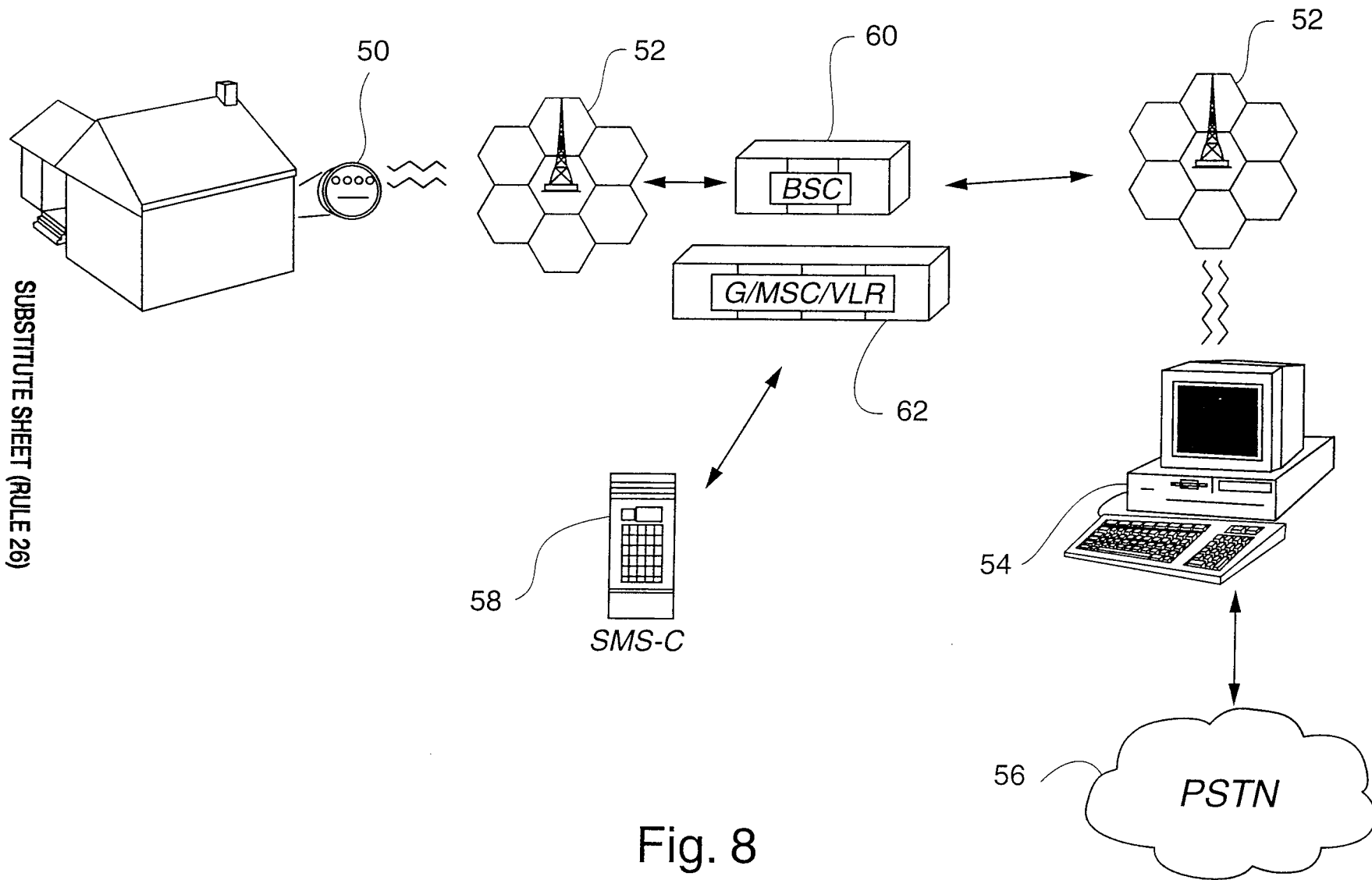

Fig. 8

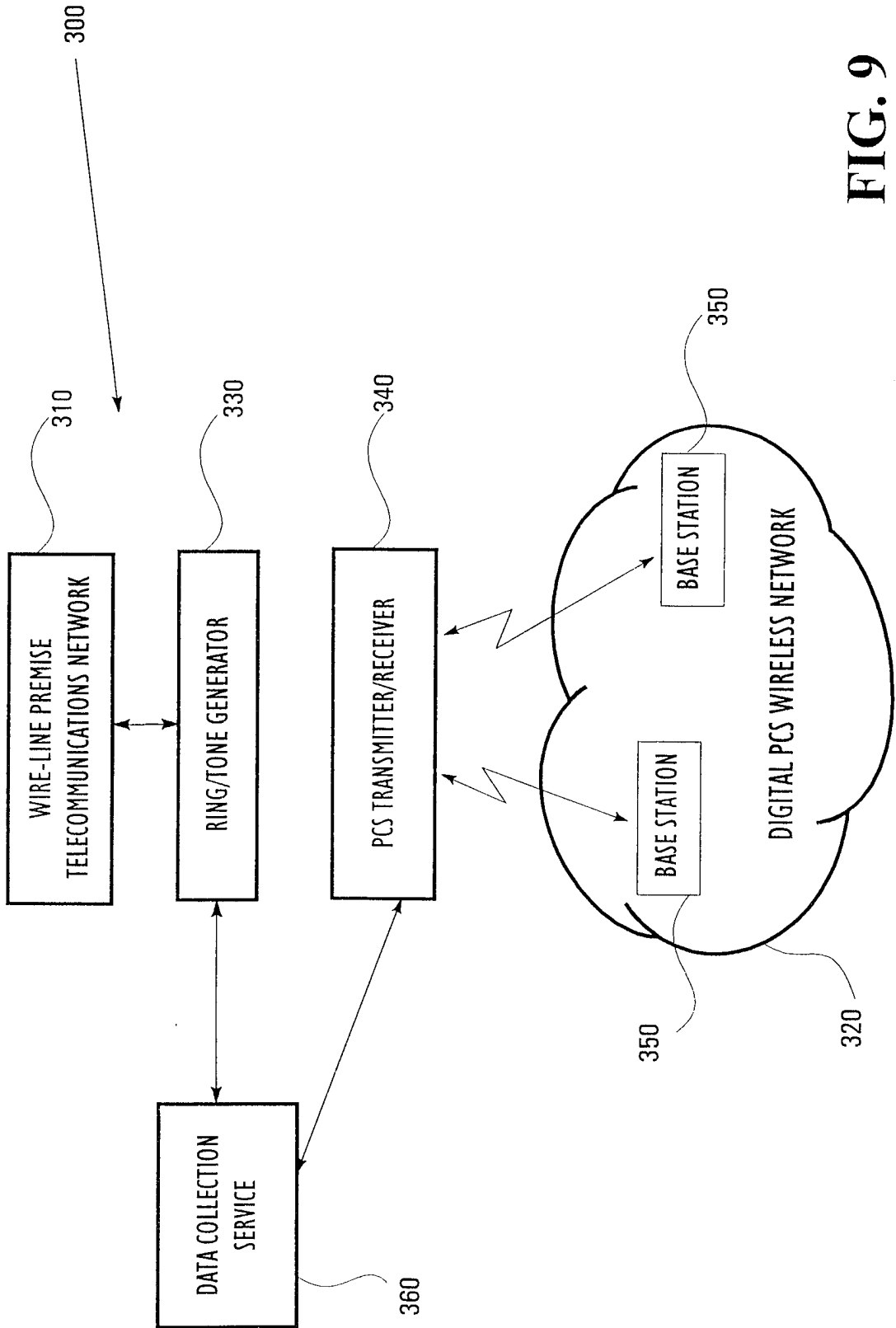

FIG. 9

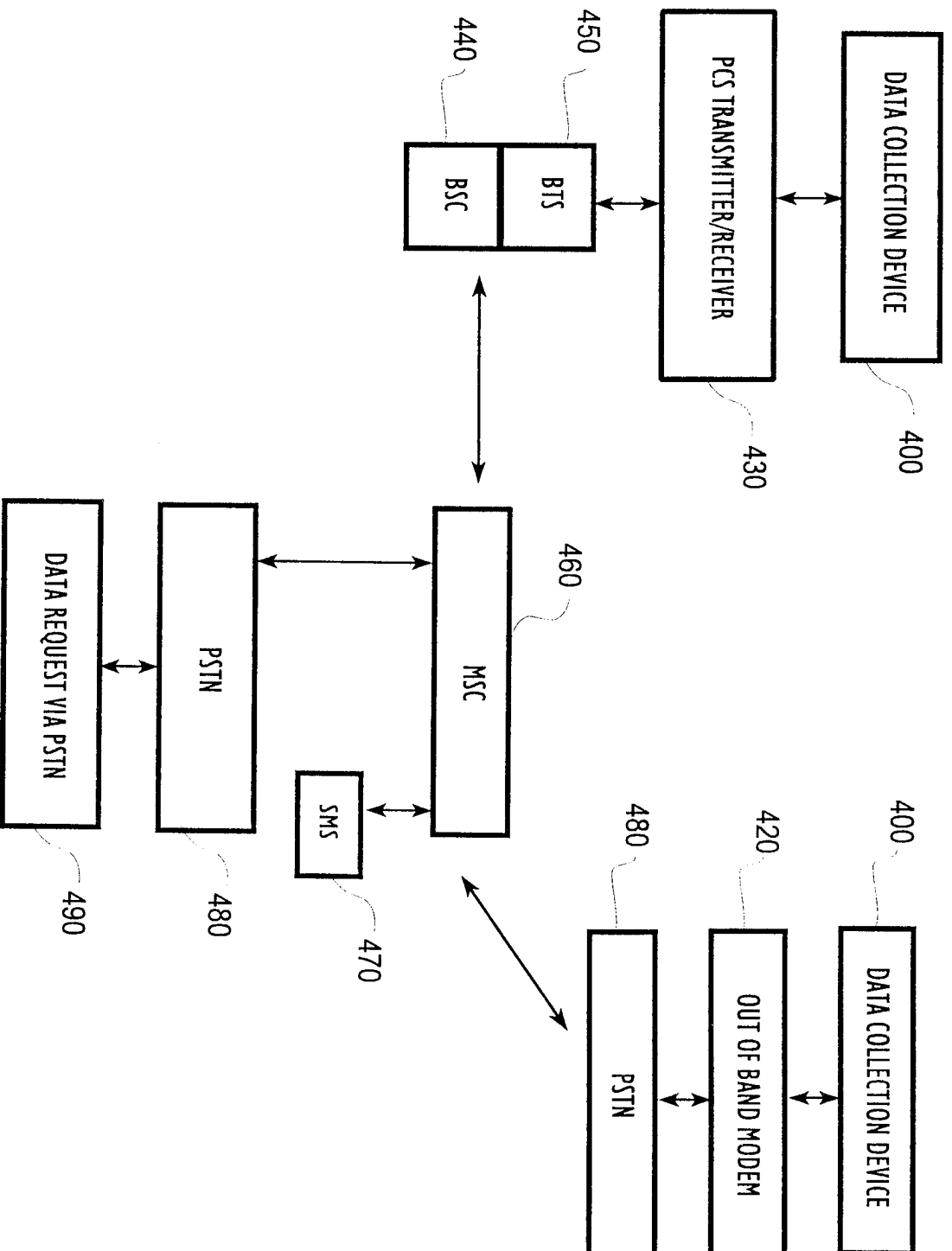

FIG. 10

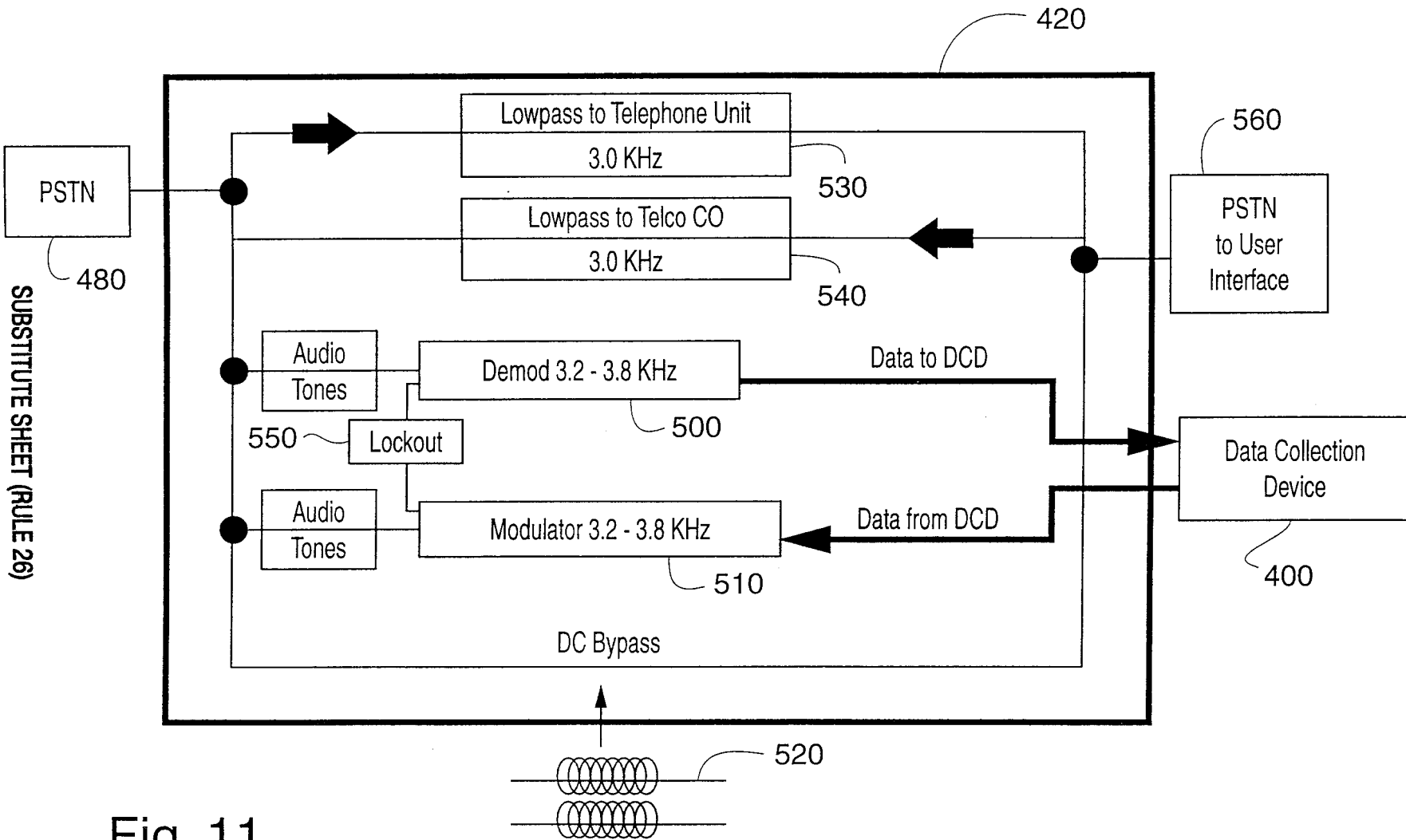

Fig. 11

SUBSTITUTE SHEET (RULE 26)

11/11

INTERNATIONAL SEARCH REPORT

International application No.
PCT/US97/19406

A. CLASSIFICATION OF SUBJECT MATTER

IPC(6) :Please See Extra Sheet.

US CL :Please See Extra Sheet.

According to International Patent Classification (IPC) or to both national classification and IPC

B. FIELDS SEARCHED

Minimum documentation searched (classification system followed by classification symbols)

U.S. : 340/870.02, 870.03, 310.01; 379/106.03, 106.07, 108.01; 455/422, 426, 552, 554, 410; 375/200; 364/481

Documentation searched other than minimum documentation to the extent that such documents are included in the fields searched

Electronic data base consulted during the international search (name of data base and, where practicable, search terms used)

APS, DIALOG

C. DOCUMENTS CONSIDERED TO BE RELEVANT

| Category* | Citation of document, with indication, where appropriate, of the relevant passages | Relevant to claim No. |
|-----------------|--|---|
| X ----- Y | US 4,940,976 A (GASTOUNIOTIS et al) 10 July 1990, figs. 8 and 9 and col. 3. | 1 and 7 ----- 2-6, 8-9 |
| X ----- Y | US 4,803,632 A (FREW et al) 07 February 1989, abstract and fig. 3 and col. 8-9. | 1 and 7 ----- 2-6, 8-9 |
| Y | US 4,538,029 A (GAZZOLI et al) 27 August 1985, entire document. | 40-48 |
| X ----- Y | US 5,214,587 A (GREEN) 25 May 1993, abstract and sol. 3-4. | 10,13-15, 17-18 ----- 11-12,16 |

Further documents are listed in the continuation of Box C. See patent family annex.

| | |
|---|--|
| * Special categories of cited documents: | *T* later document published after the international filing date or priority date and not in conflict with the application but cited to understand the principle or theory underlying the invention |
| *A* document defining the general state of the art which is not considered to be of particular relevance | *X* document of particular relevance; the claimed invention cannot be considered novel or cannot be considered to involve an inventive step when the document is taken alone |
| *E* earlier document published on or after the international filing date | *Y* document of particular relevance; the claimed invention cannot be considered to involve an inventive step when the document is combined with one or more other such documents, such combination being obvious to a person skilled in the art |
| *L* document which may throw doubts on priority claim(s) or which is cited to establish the publication date of another citation or other special reason (as specified) | *&* document member of the same patent family |
| *O* document referring to an oral disclosure, use, exhibition or other means | |
| *P* document published prior to the international filing date but later than the priority date claimed | |

Date of the actual completion of the international search

11 FEBRUARY 1998

Date of mailing of the international search report

31 MAR 1998

Name and mailing address of the ISA/US
Commissioner of Patents and Trademarks
Box PCT
Washington, D.C. 20231

Facsimile No. (703) 305-3230

Authorized officer

ALBERT WONG *Jon Hill*

Telephone No. (703) 305-8884

INTERNATIONAL SEARCH REPORT

International application No.
PCT/US97/19406

C (Continuation). DOCUMENTS CONSIDERED TO BE RELEVANT

| Category* | Citation of document, with indication, where appropriate, of the relevant passages | Relevant to claim No. |
|----------------|--|--|
| X ---- Y | US 5,546,444 A (ROACH, Jr. et al) 13 August 1996, figs. 3-6 and cols. 25-26. | 19-30 ----- 2-6, 8, 9, 11, 12, 16 |
| X | US 5,481,546 A (DINKINS) 02 January 1996, abstract and cols. 9-10. | 31-39 |
| X | US 5,553,094 A (JOHNSON et al) 03 September 1996, entire document. | 19-39 |
| A | US 5,526,403 A (TAM) 11 June 1996, entire document. | 40-48 |
| Y | US 5,544,227 A (BLUST et al) 06 August 1996, entire document. | 40-48 |
| Y | US 5,548,631 A (KREBS et al) 20 August 1996, entire document. | 40-48 |

INTERNATIONAL SEARCH REPORT

International application No.
PCT/US97/19406**Box I Observations where certain claims were found unsearchable (Continuation of item 1 of first sheet)**

This international report has not been established in respect of certain claims under Article 17(2)(a) for the following reasons:

1. Claims Nos.:
because they relate to subject matter not required to be searched by this Authority, namely:

2. Claims Nos.:
because they relate to parts of the international application that do not comply with the prescribed requirements to such an extent that no meaningful international search can be carried out, specifically:

3. Claims Nos.:
because they are dependent claims and are not drafted in accordance with the second and third sentences of Rule 6.4(a).

Box II Observations where unity of invention is lacking (Continuation of item 2 of first sheet)

This International Searching Authority found multiple inventions in this international application, as follows:

Please See Extra Sheet.

1. As all required additional search fees were timely paid by the applicant, this international search report covers all searchable claims.
2. As all searchable claims could be searched without effort justifying an additional fee, this Authority did not invite payment of any additional fee.
3. As only some of the required additional search fees were timely paid by the applicant, this international search report covers only those claims for which fees were paid, specifically claims Nos.:

4. No required additional search fees were timely paid by the applicant. Consequently, this international search report is restricted to the invention first mentioned in the claims; it is covered by claims Nos.:

Remark on Protest

- The additional search fees were accompanied by the applicant's protest.
 No protest accompanied the payment of additional search fees.

INTERNATIONAL SEARCH REPORT

International application No.
PCT/US97/19406

A. CLASSIFICATION OF SUBJECT MATTER:

IPC (6):

H04M 11/04, G08C 15/06,19/20,19/22; H04M 11/00; H04Q 7/00, 9/00; G06F 17/50; G06G 7/62

A. CLASSIFICATION OF SUBJECT MATTER:

US CL :

340/870.02, 870.03, 310.01; 379/106.03, 106.07, 108.01; 455/422, 426, 552, 554, 410; 375/200; 364/481

BOX II. OBSERVATIONS WHERE UNITY OF INVENTION WAS LACKING

This ISA found multiple inventions as follows:

This application contains the following inventions or groups of inventions which are not so linked as to form a single inventive concept under PCT Rule 13.1. In order for all inventions to be searched, the appropriate additional search fees must be paid.

Group I, claim(s) 1-9 are, drawn to an apparatus and method for sensing data, for converting the data, and for wirelessly transmitting the data in response to a remote command.

Group II, claim(s) 10-18 are, drawn to an apparatus and method for monitoring utility usage data with a means for determining utility usage by monitoring the reflected radiation from a rotating means.

Group III, claim(s) 19-30 are, drawn to a transmission protocol for a data gathering system.

Group IV, claims 31-39 are, drawn to a method of collecting data and transmitting a short message in a control channel.

Group V, claims 40-48 are, drawn to a device and a method for coupling telecommunication equipment with a digital personal communication system.

The inventions listed as Groups I-V do not relate to a single inventive concept under PCT Rule 13.1 because, under PCT Rule 13.2, they lack the same or corresponding special technical features for the following reasons: Group I relates to a method and device for sensing data and wirelessly transmitting the data in response to a command request from a remote device. Such features are not recited in the other claims. Group II relates to a device and method of monitoring utility usage by means of a rotating means for reflecting radiation. Such features are not recited in the other claims. Group III relates to a method of transmitting a data sequence using a particular protocol. Group IV relates to a method of collecting data, composing a message and transmission of the message using a personal communications system protocol. Group V relates to a method and device for coupling telecommunications equipment to a personal communications system. None of the other claims recite features of such a device.