



US00D720207S

(12) **United States Design Patent**
Fowler

(10) **Patent No.:** **US D720,207 S**

(45) **Date of Patent:** **** Dec. 30, 2014**

(54) **WIRING CLAMP**

(71) Applicant: **Jason Fowler**, Rose Hill, KS (US)

(72) Inventor: **Jason Fowler**, Rose Hill, KS (US)

(**) Term: **14 Years**

(21) Appl. No.: **29/450,395**

(22) Filed: **Mar. 18, 2013**

(51) **LOC (10) Cl.** **08-08**

(52) **U.S. Cl.**

USPC **D8/396**

(58) **Field of Classification Search**

USPC D8/356, 383, 394-396; 24/16 PB,
24/17 AP, 30.5 P, 30.5 S, 300-302, 399,
24/DIG. 16; 248/58, 60, 74.3, 71; 70/16;
128/878

See application file for complete search history.

(56) **References Cited**

U.S. PATENT DOCUMENTS

2,936,980	A *	5/1960	Rapata	24/16 PB
3,063,718	A *	11/1962	Steinkamp	473/502
D243,227	S *	2/1977	Schattner	D8/336
4,223,424	A *	9/1980	Burnett	24/30.5 R
4,510,649	A *	4/1985	Yudis et al.	24/16 PB
4,705,245	A *	11/1987	Osada	248/74.3
4,752,054	A *	6/1988	Jonsson	248/51
4,805,856	A *	2/1989	Nicoli et al.	248/74.3
D374,815	S *	10/1996	Snow	D8/394
D391,477	S *	3/1998	Bennett	D8/394
5,915,629	A *	6/1999	Ribeiro	24/16 R
D417,838	S *	12/1999	Kim	D8/396
D424,420	S *	5/2000	Kazale	D8/396
6,105,908	A *	8/2000	Kraus	248/74.3

6,490,767	B2 *	12/2002	Haiduk	24/298
D495,999	S *	9/2004	Lewis	D13/154
D513,973	S *	1/2006	Cheung	D8/394
D531,493	S *	11/2006	Ho	D8/396
D537,333	S *	2/2007	Jowsey	D8/396
D564,407	S *	3/2008	Beck	D11/200
D619,887	S *	7/2010	Colton	D8/396
8,595,904	B2 *	12/2013	Klementowicz et al.	24/16 PB
D708,930	S *	7/2014	Rothbaum et al.	D8/356
8,769,774	B2 *	7/2014	Aveni	24/68 E
2004/0139583	A1 *	7/2004	Wendle	24/16 PB
2005/0251967	A1 *	11/2005	McNeill	24/16 PB
2011/0131768	A1 *	6/2011	Watson	24/16 PB

* cited by examiner

Primary Examiner — John Windmuller

(74) *Attorney, Agent, or Firm* — Dale J. Ream

(57) **CLAIM**

The ornamental design for a wiring clamp, as shown and described.

DESCRIPTION

FIG. 1 is a perspective view of a wiring clamp showing my new design;

FIG. 2 is a front view thereof;

FIG. 3 is a back view thereof;

FIG. 4 is a left side view thereof;

FIG. 5 is a right side view thereof;

FIG. 6 is a top view thereof;

FIG. 7 is a bottom view thereof;

FIG. 8 is an exploded view as shown in FIG. 1 thereof;

FIG. 9 is another perspective view illustrating use of the wiring clamp thereof; and,

FIG. 10 is another perspective view as in FIG. 9 in a final use configuration.

1 Claim, 6 Drawing Sheets

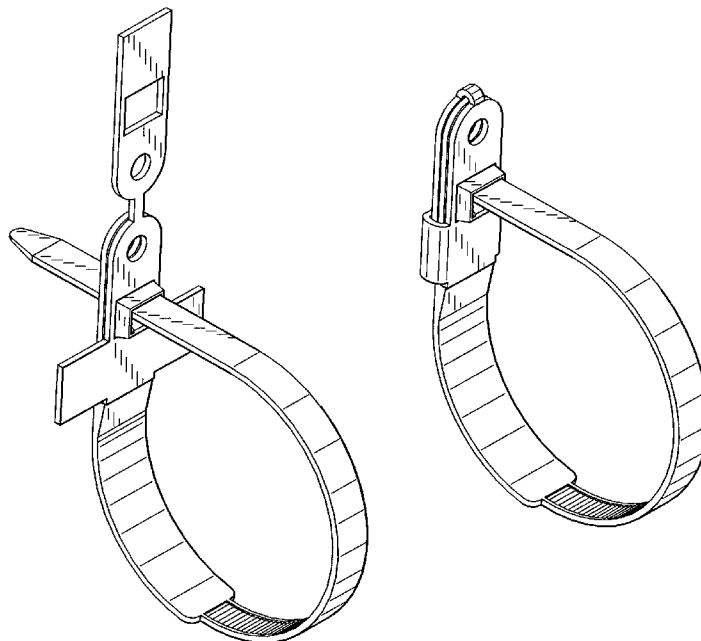

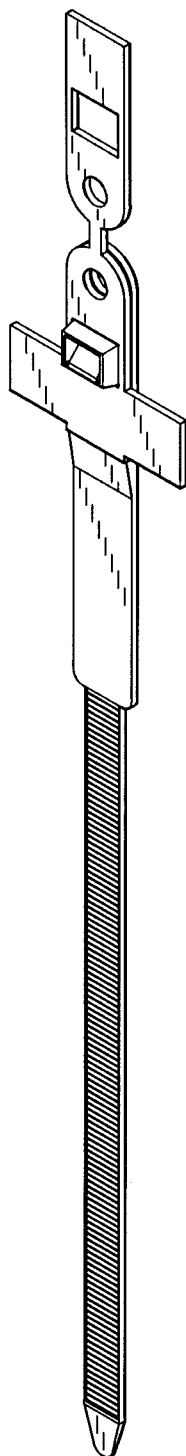

Fig. 1

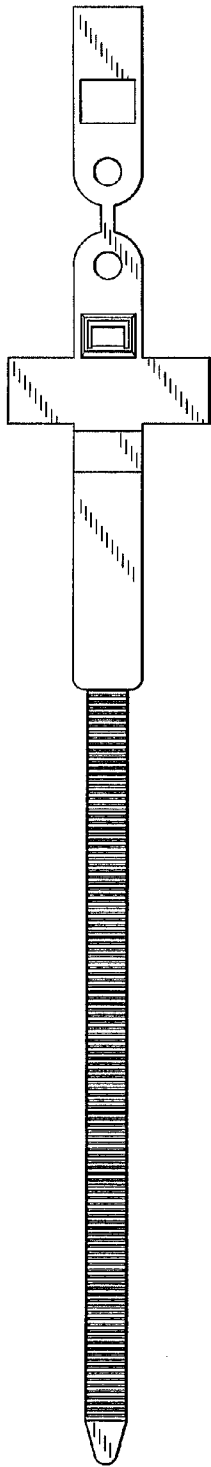

Fig. 2

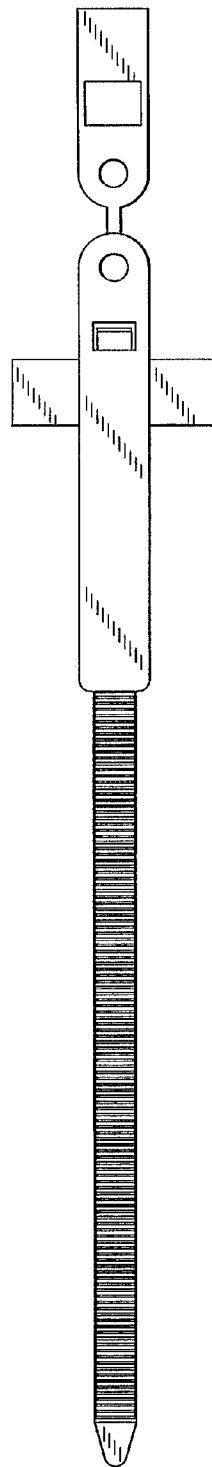

Fig. 3



Fig. 4



Fig. 5

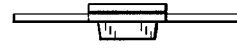

Fig. 6



Fig. 7

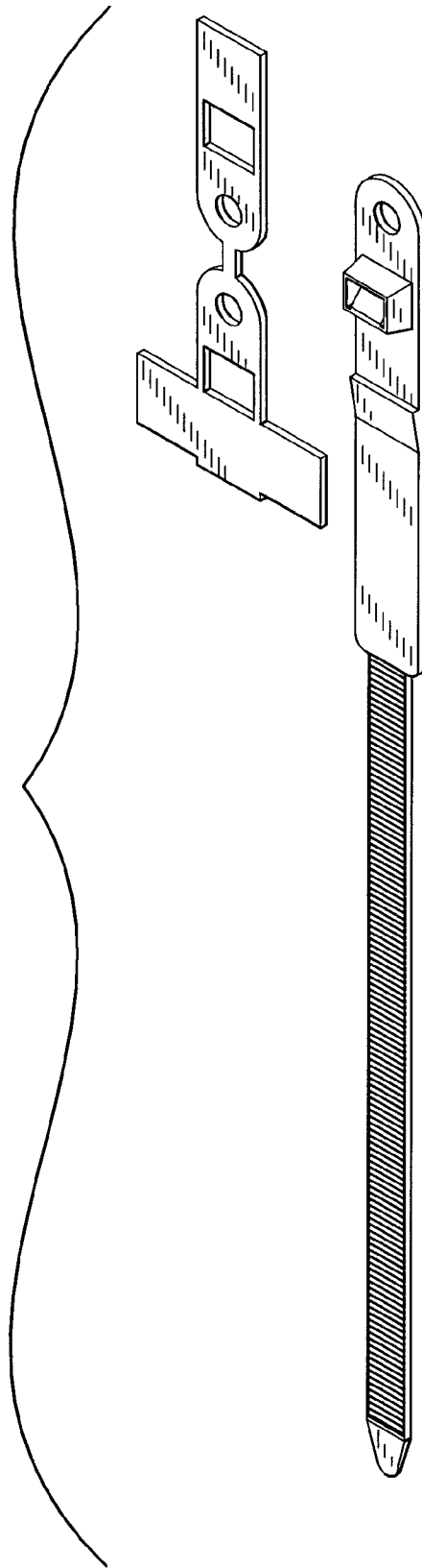

Fig. 8

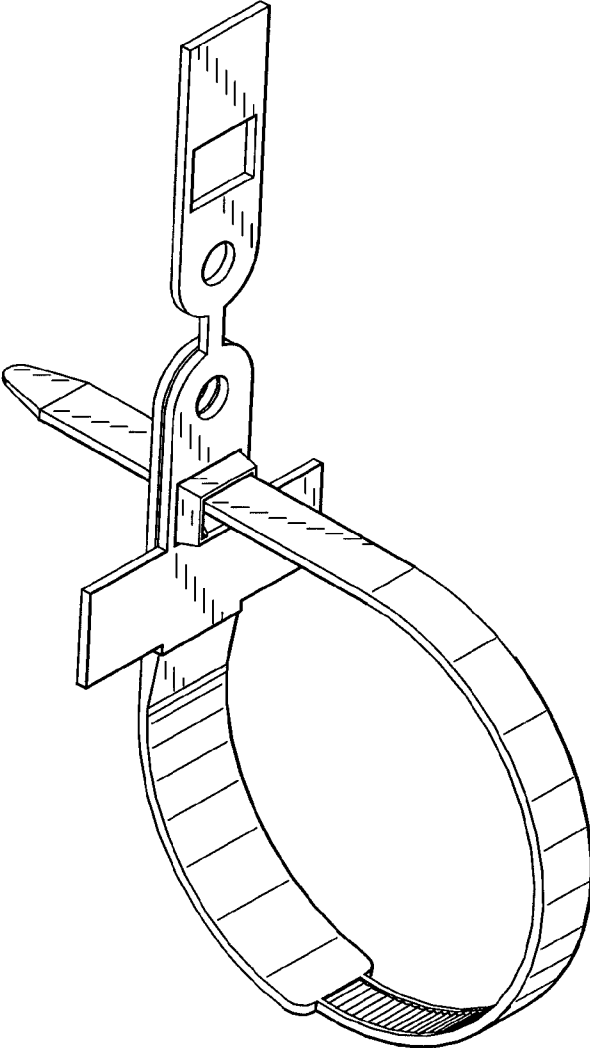

Fig. 9

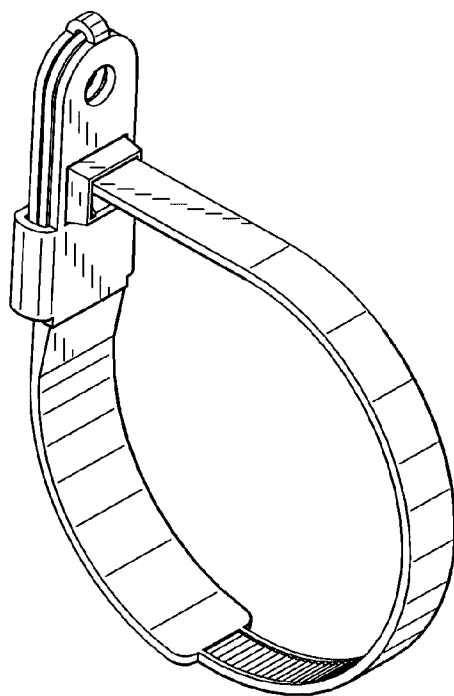

Fig. 10