



US00D470511S

(12) **United States Design Patent**
Woolard

(10) **Patent No.:** **US D470,511 S**

(45) **Date of Patent:** **** Feb. 18, 2003**

(54) **RIDING LAWN MOWER**

(76) **Inventor:** **Billy G. Woolard, 707 Clermont Rd.,
New Bern, NC (US) 28560-7841**

(**) **Term:** **14 Years**

(21) **Appl. No.:** **29/155,705**

(22) **Filed:** **Feb. 15, 2002**

(51) **LOC (7) Cl.** **15-03**

(52) **U.S. Cl.** **D15/15**

(58) **Field of Search** D15/14, 15; D21/533,
D21/537, 548, 549, 551; D12/82, 83, 86;
56/12.1, 12.7, 12.8, 13.4, 13.7, 16.7, 17.1,
17.5, 320.1, 320.2; 180/89.1, 89.12, 900

(56) **References Cited**

U.S. PATENT DOCUMENTS

3,732,671	A	5/1973	Allen et al.	
5,007,234	A	4/1991	Shurman et al.	
D346,809	S	5/1994	Burgos et al.	
D349,078	S	* 7/1994	Kimura et al.	D12/107
5,361,568	A	11/1994	Lin	

D363,939	S	11/1995	Kato et al.	
D398,014	S	* 9/1998	Wolf	D15/15
D409,628	S	* 5/1999	Shimamura et al.	D15/15
D423,520	S	4/2000	Smith	

* cited by examiner

Primary Examiner—Mitchell Siegel

(74) *Attorney, Agent, or Firm*—Donald R. Schoonover

(57) **CLAIM**

The ornamental design for a riding lawn mower, as shown and described.

DESCRIPTION

FIG. 1 is a perspective view of a riding lawn mower embodying the design of the present invention.
 FIG. 2 is an front elevational view thereof;
 FIG. 3 is a rear elevational view thereof;
 FIG. 4 is a left side elevational view thereof;
 FIG. 5 is a right side elevational view thereof;
 FIG. 6 is a top plan view thereof; and,
 FIG. 7 is a bottom plan view thereof.

1 Claim, 4 Drawing Sheets

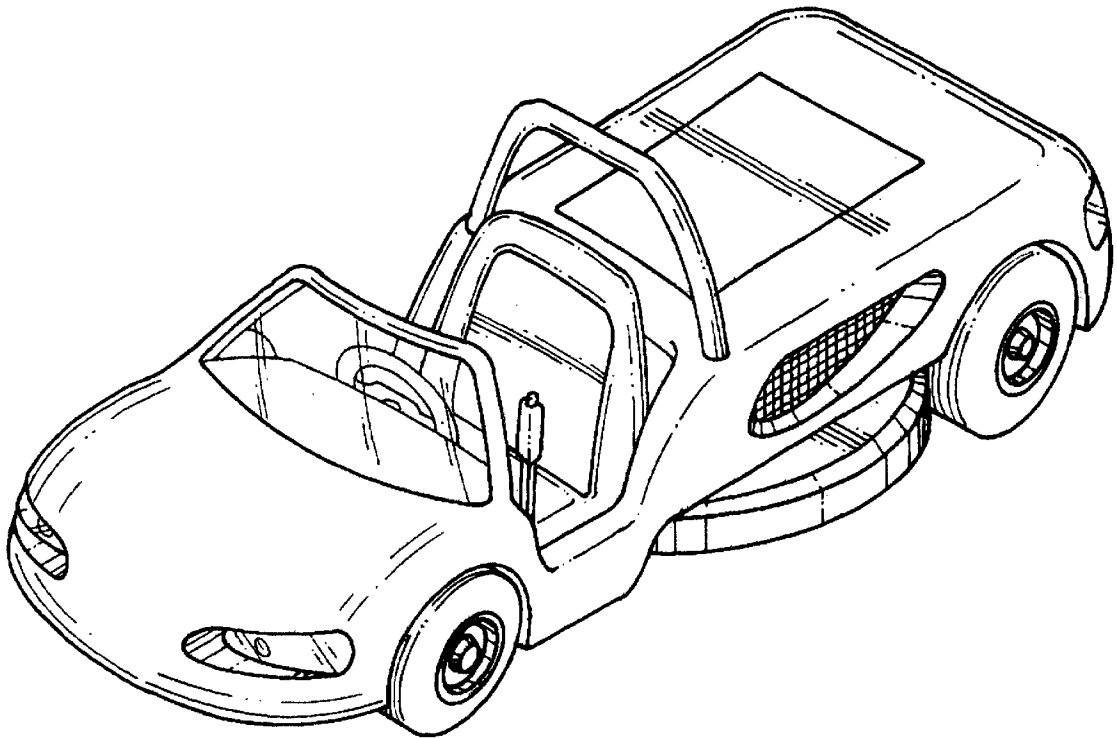

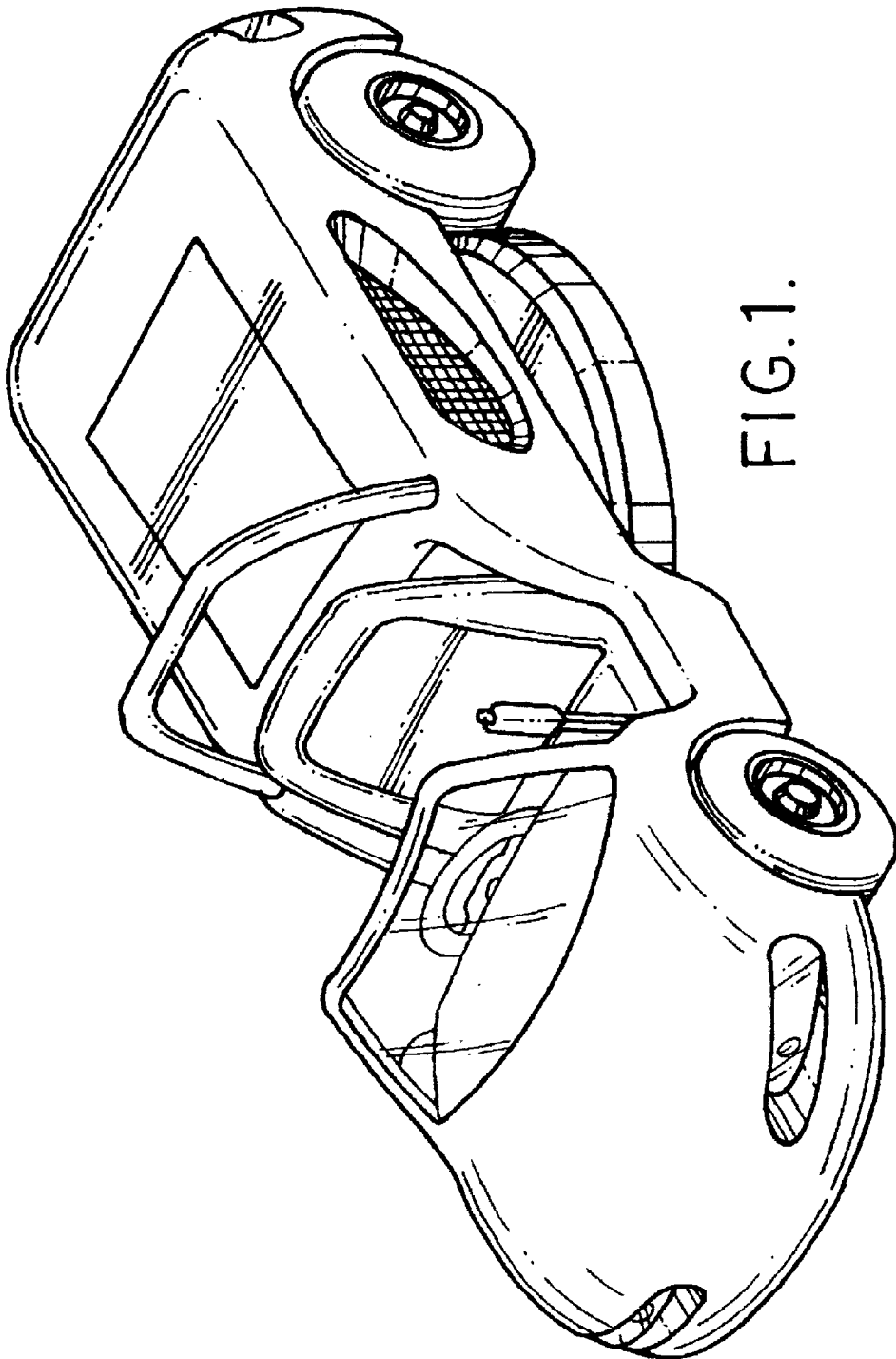

FIG. 1.

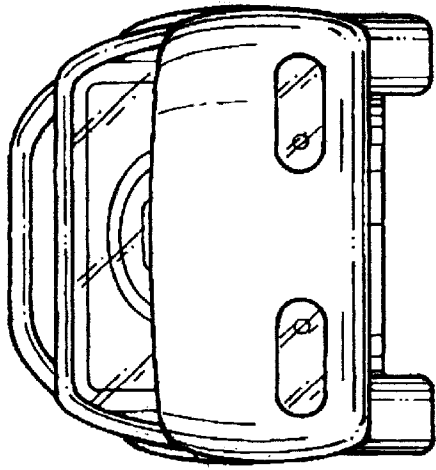

FIG. 2.

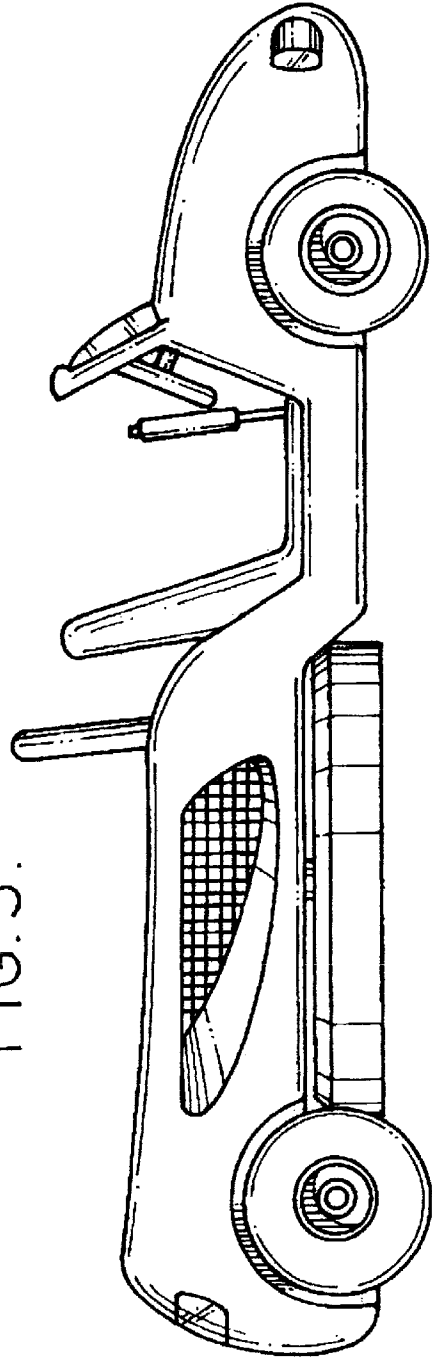

FIG. 5.

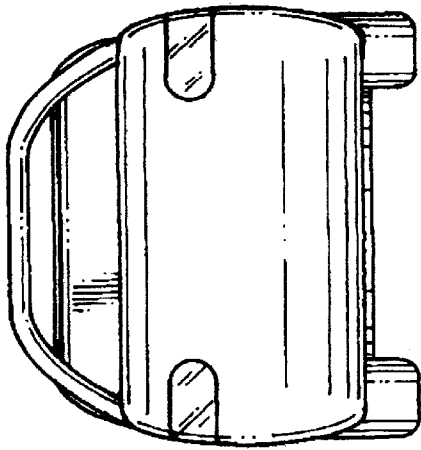

FIG. 3.

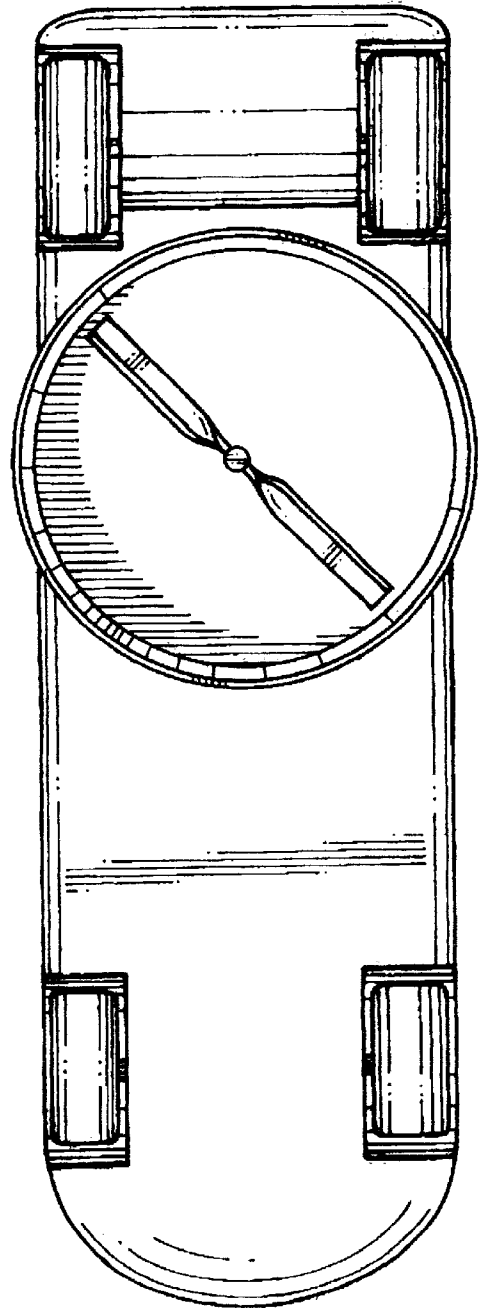

FIG. 7.

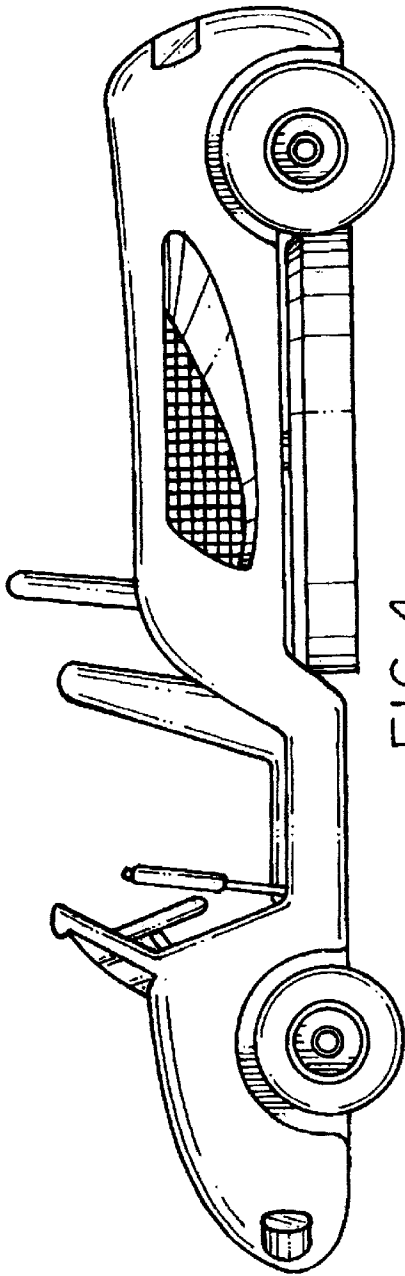

FIG. 4.

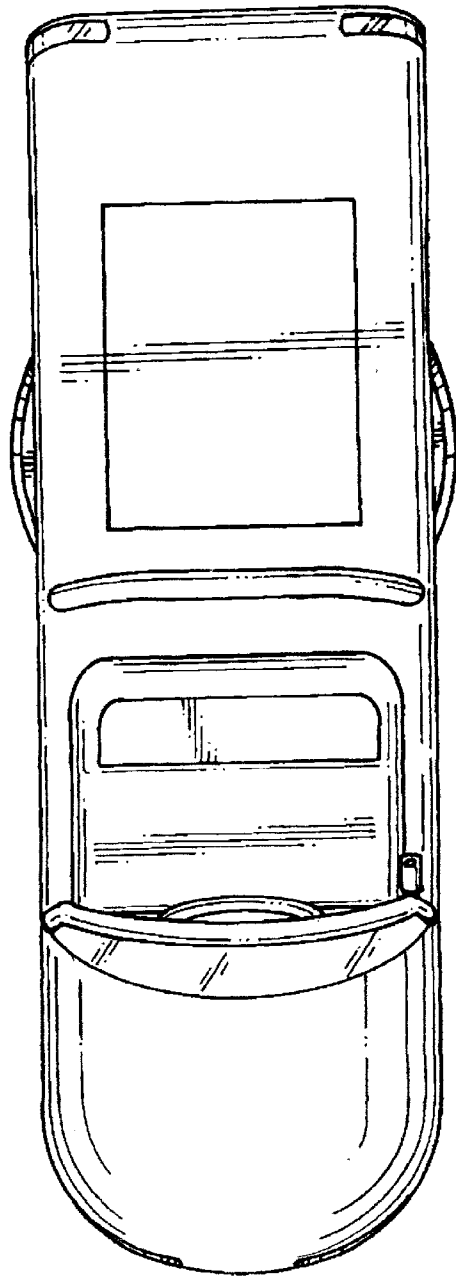

FIG. 6.