



(86) Date de dépôt PCT/PCT Filing Date: 2016/02/05
 (87) Date publication PCT/PCT Publication Date: 2016/08/11
 (45) Date de délivrance/Issue Date: 2023/09/26
 (85) Entrée phase nationale/National Entry: 2017/08/03
 (86) N° demande PCT/PCT Application No.: US 2016/016877
 (87) N° publication PCT/PCT Publication No.: 2016/127122
 (30) Priorité/Priority: 2015/02/06 (US62/113,282)

(51) Cl.Int./Int.Cl. *H01M 50/242* (2021.01),
H01G 11/12 (2013.01), *H01M 50/264* (2021.01),
H01M 50/291 (2021.01), *H01M 8/248* (2016.01)
 (72) Inventeurs/Inventors:
 CHANG, FU KUO, US;
 NARDARI, RAPHAEL GERARD CHRISTIAN, US;
 LADPLI, PURIM, US
 (73) Propriétaire/Owner:
 THE BOARD OF TRUSTEES OF THE LELAND
 STANFORD JUNIOR UNIVERSITY, US
 (74) Agent: SMART & BIGGAR LP

(54) Titre : COMPOSITES DE STOCKAGE D'ENERGIE MULTIFONCTION
 (54) Title: MULTIFUNCTIONAL ENERGY STORAGE COMPOSITES

Multifunctional Energy-Storage Composites (MES Composites)

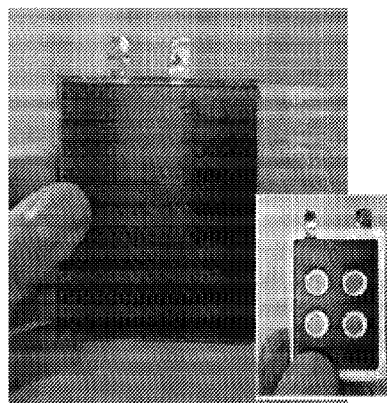
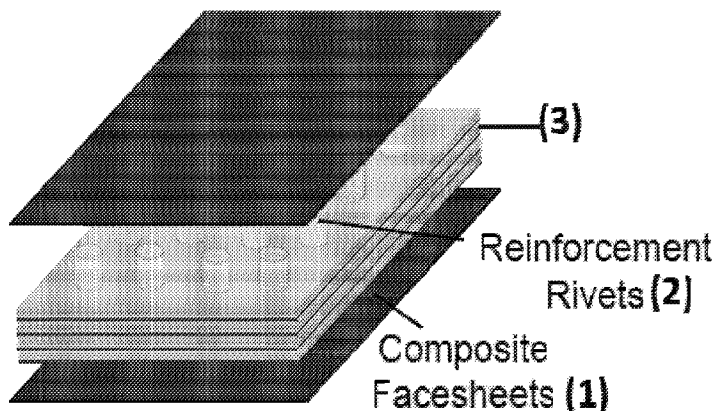

MES Composite Sample

(57) Abrégé/Abstract:

Described here is a multifunctional energy storage (MES) composite comprising (a) a stack of energy storage materials and (b) one or more structural facesheets sandwiching the stack of energy storage materials, wherein the stack of battery materials is perforated by (c) one or more reinforcements, and wherein the reinforcements are bonded to the structural facesheets. Also described here is a MES composite comprising (a) a stack of energy storage materials, (b) one or more structural facesheets sandwiching the stack of energy storage materials, and (c) one or more reinforcements perforated by the stack of energy storage materials, wherein the reinforcements are bonded to the structural facesheets.

(12) INTERNATIONAL APPLICATION PUBLISHED UNDER THE PATENT COOPERATION TREATY (PCT)

(19) World Intellectual Property
Organization
International Bureau(10) International Publication Number
WO 2016/127122 A1(43) International Publication Date
11 August 2016 (11.08.2016)

(51) International Patent Classification:

H01M 4/70 (2006.01) *H01M 10/02* (2006.01)
H01M 4/38 (2006.01) *H01M 8/00* (2006.01)
H01M 4/02 (2006.01) *H01M 12/08* (2006.01)
H01M 6/02 (2006.01)

(21) International Application Number:

PCT/US2016/016877

(22) International Filing Date:

5 February 2016 (05.02.2016)

(25) Filing Language:

English

(26) Publication Language:

English

(30) Priority Data:

62/113,282 6 February 2015 (06.02.2015) US

(71) Applicant: **THE BOARD OF TRUSTEES OF THE LE-
LAND STANFORD JUNIOR UNIVERSITY** [US/US];
3000 El Camino Real, Building 5, Suite 300, Palo Alto,
California 94306-2100 (US).

(72) Inventors: **CHANG, Fu Kuo**; c/o Stanford University,
3375 Hillview Avenue, Palo Alto, California 94304 (US).
NARDARI, Raphael Gerard Christian; c/o Stanford
University, 3375 Hillview Avenue, Palo Alto, California
94304 (US). **LADPLI, Purim**; c/o Stanford University,
3375 Hillview Avenue, Palo Alto, California 94304 (US).

(74) Agents: **LIU, Cliff Z.** et al.; Foley & Lardner LLP, 3000 K
Street N.W., Suite 600, Washington, District of Columbia
20007-5109 (US).

(81) Designated States (*unless otherwise indicated, for every
kind of national protection available*): AE, AG, AL, AM,
AO, AT, AU, AZ, BA, BB, BG, BH, BN, BR, BW, BY,
BZ, CA, CH, CL, CN, CO, CR, CU, CZ, DE, DK, DM,
DO, DZ, EC, EE, EG, ES, FI, GB, GD, GE, GH, GM, GT,
HN, HR, HU, ID, IL, IN, IR, IS, JP, KE, KG, KN, KP, KR,
KZ, LA, LC, LK, LR, LS, LU, LY, MA, MD, ME, MG,
MK, MN, MW, MX, MY, MZ, NA, NG, NI, NO, NZ, OM,
PA, PE, PG, PH, PL, PT, QA, RO, RS, RU, RW, SA, SC,
SD, SE, SG, SK, SL, SM, ST, SV, SY, TH, TJ, TM, TN,
TR, TT, TZ, UA, UG, US, UZ, VC, VN, ZA, ZM, ZW.

(84) Designated States (*unless otherwise indicated, for every
kind of regional protection available*): ARIPO (BW, GH,
GM, KE, LR, LS, MW, MZ, NA, RW, SD, SL, ST, SZ,
TZ, UG, ZM, ZW), Eurasian (AM, AZ, BY, KG, KZ, RU,
TJ, TM), European (AL, AT, BE, BG, CH, CY, CZ, DE,
DK, EE, ES, FI, FR, GB, GR, HR, HU, IE, IS, IT, LT, LU,
LV, MC, MK, MT, NL, NO, PL, PT, RO, RS, SE, SI, SK,
SM, TR), OAPI (BF, BJ, CF, CG, CI, CM, GA, GN, GQ,
GW, KM, ML, MR, NE, SN, TD, TG).

Declarations under Rule 4.17:

— *as to the applicant's entitlement to claim the priority of the
earlier application (Rule 4.17(iii))*

[Continued on next page]

(54) Title: MULTIFUNCTIONAL ENERGY STORAGE COMPOSITES

Multifunctional Energy-Storage Composites (MES Composites)

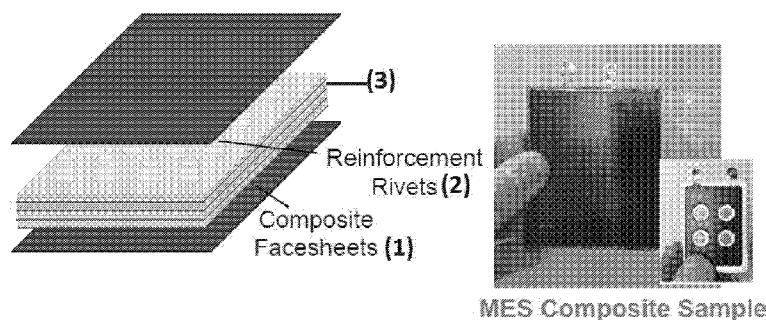

FIGURE 1

(57) Abstract: Described here is a multifunctional energy storage (MES) composite comprising (a) a stack of energy storage materials and (b) one or more structural facesheets sandwiching the stack of energy storage materials, wherein the stack of battery materials is perforated by (c) one or more reinforcements, and wherein the reinforcements are bonded to the structural facesheets. Also described here is a MES composite comprising (a) a stack of energy storage materials, (b) one or more structural facesheets sandwiching the stack of energy storage materials, and (c) one or more reinforcements perforated by the stack of energy storage materials, wherein the reinforcements are bonded to the structural facesheets.

WO 2016/127122 A1 

Published:

— *with international search report (Art. 21(3))*

MULTIFUNCTIONAL ENERGY STORAGE COMPOSITES

CROSS-REFERENCE TO RELATED APPLICATIONS

[0001]

FEDERAL FUNDING STATEMENT

[0002] This invention was made with Government support under Contract No. DE-AR0000393, awarded by U.S. Department of Energy. The Government has certain rights in the invention.

BACKGROUND

[0003] Research interest in electrochemical energy storage devices has grown substantially in the past few decades. Cutting-edge advanced energy storage technologies have expanded the capabilities of a wide range of electric-powered engineering platforms, from portable electronic devices and biomedical devices, to electric vehicles, to air and spacecraft technologies. Current state-of-the-art electrochemical storage technologies are specifically engineered to primarily satisfy the energy-capacity and power-consumption requirements of the electronic devices. As a result, conventional batteries and electrochemical cells add significant weight and volume without contributing to other functionalities of the system, for instance to the mechanical integrity or the structural performance. The extra weight and volume significantly hinder the system performance and efficiency.

SUMMARY

[0004] System improvement can be achieved by making the energy storage multifunctional. Through proper integration of the constituent materials, an electrochemical energy storage can be made capable of synergistically store and provide energy, as well as carry mechanical loads and provide structural integrity to the device. The multifunctional energy storage can be used as a substitution for the otherwise necessary supporting structures in the traditional electric-powered systems.

[0005] The multifunctional energy storage (MES) composite described herein embeds electrochemical energy storage materials into structural facesheets and uses through-thickness reinforcements to provide structural rigidity, akin to a sandwich structure construction. The MES composite, when incorporated into an electric-powered device or

vehicle, contributes to both the energy storage and mechanical strength capabilities resulting in system weight savings and higher energy efficiency.

[0006] This invention described herein is in the field of energy storage and relates generally to incorporating an energy storage device into a structural material resulting in a multifunctional structural energy storage for use in energy-storage, energy-generation, or electric-powered systems.

[0007] One aspect of some embodiments of the invention relates to a multifunctional energy storage (MES) composite comprising (a) a stack of energy storage materials, (b) two structural facesheets sandwiching the stack of energy storage materials, (c) one or more reinforcements perforating the stack of energy storage materials, and (d) a reinforcement frame disposed along a lateral perimeter of the stack of energy storage materials and between the structural facesheets, wherein the reinforcements are bonded to the structural facesheets, wherein one or more of the reinforcements enhance battery rigidity and further comprise a thermal device selected from a group comprising a heat sink, a heat source, a heat pipe, and heat transfer rods arranged such that each heat transfer rod extends a length along an alignment axis passing through the perforations in the stack of energy storage materials, and wherein the heat transfer rods are positioned in thermal communication with one of a heat sink and a heat source.-

[0007a] There is also described a multifunctional energy storage (MES) composite comprising (a) a stack of energy storage materials, (b) two structural facesheets sandwiching the stack of energy storage materials, (c) one or more reinforcements perforating the stack of energy storage materials, and (d) a reinforcement frame disposed along an entire lateral perimeter of the stack of energy storage materials and between the structural facesheets, wherein the reinforcements are bonded to the structural facesheets, wherein one or more of the reinforcements enhance battery rigidity and further comprise cables or conduits for electrical signal transmission and electrical conduction.

[0007b] There is also described a multifunctional energy storage (MES) comprising (a) a stack of energy storage materials, (b) two structural facesheets sandwiching the stack of energy storage materials, (c) one or more reinforcements perforating the stack of energy storage materials, and (d) a reinforcement frame disposed along an entire lateral perimeter of the stack of energy storage materials and between the structural facesheets, wherein the reinforcements are bonded to the structural facesheets, wherein one or more of the

reinforcements enhance battery rigidity and further comprise at least one sensor selected from a group comprising strain gauges, thermocouples, thermistors, pressure sensors, tactile sensors, piezoelectric sensors, voltage sensors, current sensors, and humidity sensors.

[0007c] There is also described a MES composite comprising (a) a stack of energy storage materials, (b) one or more structural facesheets sandwiching the stack of energy storage materials, and (c) one or more reinforcements perforated by the stack of energy storage materials, wherein the reinforcements are bonded to the structural facesheets.

[0007d] There is also described a MES composite comprising (a) a stack of energy storage materials, (b) one or more structural facesheets sandwiching the stack of energy storage materials, (c) a reinforcement case perforated by the stack of energy storage materials, and (d) one or more secondary reinforcements perforating the stack of energy storage materials, wherein the reinforcement case and the second reinforcements are bonded to the structural facesheets.

[0008] In another aspect of some embodiments of the invention, rather than having the reinforcements disposed in the perforations or apertures of the stack of energy storage materials, the reinforcements themselves can comprise an array of perforations or apertures along an alignment axis parallel to the thickness direction, wherein the apertures or perforations in the reinforcements are filled with the energy storage materials.

[0009] The stack of energy storage materials can be a component of an electrochemical cell and wherein the electrochemical cell is selected from the group consisting of: a primary cell, a secondary cell (including but not limited to a lithium cell, a lithium ion cell, a lead-acid cell, a zinc-carbon cell, an alkaline cell, a nickel-cadmium cell, a nickel metal hydride cell, a silver oxide cell, a sodium sulfur cell, etc.), a solid electrochemical cell, a fluid electrochemical cell, a flow battery, a fuel cell, a capacitor, a supercapacitor, a semi-solid battery, and a metal-air battery.

[0010] A further aspect of some embodiments of the invention relates to an energy storage device comprising the MES composites.

[0011] These and other features, together with the organization and manner of operation thereof, will become apparent from the following detailed description when taken in conjunction with the accompanying drawings.

BRIEF DESCRIPTION OF THE DRAWINGS

[0012] Figure 1 shows schematically an example MES composite described herein.

[0013] Figure 2 shows in-plane mechanical performance of an example MES composite. The MES composite was loaded (mechanically) in tension and was found to be stiffer than a conventional Li-ion battery cell.

[0014] Figure 3 shows the results of a three-point bending test. An example MES composite was placed on a span, supported at two ends. Another rigid fixture was driven from the top and pressed on to the middle of the sample, causing the sample to 'bend'. The bending rigidity is a measure of the resistance of the sample to the bending. The MES composite was found to be more rigid (resistant to bending) than a conventional Li-ion battery cell.

[0015] Figure 4 shows an example MES composite under in-plane compression. Under in-plane compression, a thin, slender sample tends to deform out-of-plane, or so-called, buckles. The resistance to buckling of MES composites was much higher than regular Li-ion cells.

[0016] Figure 5 shows electrochemical performance of an example MES composite. The MES composite is shown to have substantially uncompromised electrochemical performance despite the introduction of unconventional structural materials into a battery cell.

[0017] Figure 6 shows schematically example vertical integration of the MES composites into an electric vehicle chassis.

[0018] Figure 7 shows schematically example scaling-up of the MES composites to produce an electric vehicle chassis.

[0019] Figure 8 shows schematically an example MES composite described herein and a cross-section image thereof.

[0020] Figure 9 shows a cross-section of an example MES composite described herein and an image thereof.

[0021] Figure 10 shows schematically an example MES composite described herein.

[0022] Figure 11 shows comparison between (a) standard Li-ion pouch cells and (b) MES composites. MES composites employ through-thickness reinforcements which transfer mechanical loads between two structural facesheets and improve shear resistance of the battery core.

[0023] Figure 12 shows manufactured samples (Top) Sample A – Non-perforated electrode stack packaged in aluminum-laminate pouch; (Bottom) MES composite Samples B, C, D with the same external dimensions.

[0024] Figure 13 shows anode dimensions and locations of perforations for Samples A and B (Left), Sample C (Middle), and Sample D (Right).

[0025] Figure 14 shows (top) an example MES composite assembly and internal components; (bottom) dimensions of the edge-filling frame.

[0026] Figure 15 shows three-point-bending test setup for Samples B, C, and D.

[0027] Figure 16 shows voltage and current time-history for a nominal cycle of Sample C at C/3 rate.

[0028] Figure 17 shows cell DC impedance calculated from the HPPC test profile during a C/3 discharge (1 hour rest, 30s 1C discharge pulses).

[0029] Figure 18 shows capacity retention, as percentage of the first discharge capacity, with increasing cycle number for Samples A, C and D.

[0030] Figure 19 shows load-displacement curves from the three-point bending test for representative Samples B, C, and D.

[0031] Figure 20 shows voltage versus depth of discharge (DoD) for a C/3 discharge of a representative Sample D at the pristine condition, and after 1mm and 2mm mid-span mechanical bending has been applied.

[0032] Figure 21 shows effects on discharge capacity due to mechanical bending loads for Samples B, C, and D. Normalized discharge capacity after 1 and 2 mm deflection has been applied at mid-span, in comparison with that at pristine condition.

[0033] Figure 22 shows effects on cell DC impedance due to mechanical bending loads for Samples B, C, and D. Normalized cell impedance at 50% DoD after 1 and 2 mm deflection has been applied at mid-span, in comparison with that at pristine condition.

[0034] Figure 23 shows an example configuration of the MES composite.

[0035] Figure 24 shows example configurations of the MES composite. The MES composite does not need to be flat. It can be made into a curved plate, or with compound curves, or other more complex geometries. The orientation of the MES composite does not need to be horizontal. It can be oriented in any other orientations including vertical (e.g., an MES Composite rotated 0-360 degrees with respect to those shown in the figure).

[0036] Figure 25 shows example perforation patterns of electrode stacks and reinforcement structures.

[0037] Figure 26 shows example perforation patterns of electrode stacks and reinforcement structures.

[0038] Figure 27 shows example perforation patterns of electrode stacks and reinforcement structures.

[0039] Figure 28 shows compound reinforcements (multi-stage reinforcements) for the MES composites. The first-tier/outer reinforcement has an array of openings. The openings are filled with electrode materials which contain an array of perforations. The perforations in each electrode stack are subsequently filled with second-tier/inner reinforcements. The reinforcements and the electrode stacks are sandwiched between two structural facesheets.

[0040] Figure 29 shows the use of a plurality of MES composite cells as structural component.

[0041] Figure 30 shows cross-sectional view of example reinforcement structures.

DETAILED DESCRIPTION

[0042] **Introduction.** The MES composite described herein is designed to solve the issues of conventional stack designs of a pouch cell, by of anchoring the battery layers and further reinforcing them with the outer structural materials. As shown in Figures 1 and 10, in some embodiments, the MES composite comprises polymer reinforcements (2), which form an through-thickness anchor linking the electrode stack (3) together and also connect to the two structural facesheets (1) on either side. The polymer reinforcements are distributed at various locations across the cell platform, helping maintaining the rigidity of the battery-and-carbon-carbon fiber sandwich.

[0043] With such a design, the in-plane load transfer and the bending rigidity of the battery cell can be increased. Commercial electrochemical cells or batteries are not designed to carry mechanical loads. For example, in commercial lithium-ion pouch battery designs, when an

in-plane load is applied on the pouch, since there is just marginal friction but no adhesion between the battery layers, it is essentially the pouch that carries the entire load. Whereas in the MES composite design described herein, not only the structural composite panels on either side help alleviate part of the load, but also the load on the composite can be transferred through the reinforcements to the active materials, which also contribute to load carrying.

[0044] Another benefit comes from the increased bending rigidity. In the case of a conventional pouch cell, since the layers are not adhered together and can slide relative to each other, the thin layers are bent individually upon application of an out of plane bending. However in the reinforced cell design, there is no sliding, the thin layers join up and are bent together. The bending rigidity can be significantly increased. Additionally, there are much stiffer components on either surface, which further enhances the stiffness in bending.

[0045] The MES composite can be scaled up into a module. In one non-limiting example, the module can be made and oriented vertically as a slab of battery module, as shown in Figure 6. This can either serve as shear webs, or directly be used as the main bending load bearing components, because of its relative large stiffness due to the vertical orientation. Figure 7 shows an overall approach of a system level assembly concept. The bonding joints between the top and bottom plates with the vertical shear web should provide the means of load transferring from the top and bottom plates to the shear webs, and also effectively bond the vertical slabs together to prevent individual buckling. One embodiment of the bonding joints are the CFRP T-joints illustrated in Figure 7. Other embodiments of the bonding joints include composite plates with teeth and bolt bonding.

[0046] **MES Composite.** One aspect of some embodiments of the invention relates to is an MES composite comprising (a) a stack of energy storage materials and (b) one or more structural facesheets sandwiching the stack of energy storage materials, wherein the stack of battery materials is perforated by (c) one or more reinforcements, and wherein the reinforcements are bonded to the structural facesheets. Another aspect of some embodiments of the invention relates to an MES composite comprising (a) a stack of energy storage materials, (b) one or more structural facesheets sandwiching the stack of energy storage materials, and (c) one or more reinforcements perforated by the stack of energy storage materials, wherein the reinforcements are bonded to the structural facesheets.

[0047] The MES composite can have any orientation. For example, in one embodiment, the MES composite is arranged such that the electrode stack have a horizontal orientation. In another embodiment, however, the MES composite is arranged such that the electrode stack have a vertical orientation. In one embodiment, the MES composite is arranged such that the reinforcements have a vertical orientation. In another embodiment, however, the MES composite is arranged such that the reinforcements have a horizontal orientation. Optionally, the MES composite can be flat (planar), or made into a curved geometry, or a more complex geometry, as shown in Figure 24.

[0048] **Electrode Stack.** The MES composite can comprise an electrode stack for energy storage, as shown in Figure 23. In one embodiment, the MES composite comprises a lithium-ion (Li-ion) battery core. In one embodiment, the MES composite comprises a non-Li-ion battery core (e.g., nickel-metal hydride (NiMH), nickel-cadmium (NiCd), alkaline cell, lithium-sulfur (Li-S), lithium-titanate (LTO), etc.) The electrode stack can also be a component of an electrochemical cell and wherein the electrochemical cell is selected from the group consisting of : a primary cell, a secondary cell (including a lithium cell, a lithium ion cell, a lead-acid cell, a zinc-carbon cell, an alkaline cell, a nickel-cadmium cell, a nickel metal hydride cell, a silver oxide cell, a sodium sulfur cell, etc.), a solid electrochemical cell, a fluid electrochemical cell, a flow battery, a fuel cell, a capacitor, a supercapacitor, a semi-solid battery, and a metal-air battery.

[0049] In embodiments, the thickness of the electrode stack core can be, for example, within the range of 10 nm to 5 cm. The electrode stack has one or more lateral dimensions between 1 cm to 20 m.

[0050] One aspect of the electrode stack described here is that the stack is perforated according to the desired placement of the through-thickness reinforcement array. Useful perforation shapes include, but are not limited to, circular, square, rectangular, and polygonal. The perforations (or holes or apertures) can be of any shapes. In one embodiment, the shape of the perforation is circular. The diameter (or lateral dimension) of the perforations can be, for example, from about 0 to about 5 cm wide. Optionally, each perforation in the electrode stack has identical or substantially identical dimensions and/or shapes. Optionally, the dimensions and/or shape of the perforations are independent. Optionally, each perforation has a lateral dimension identical, substantially identical, more than 2 times the lateral dimension of the reinforcements. The perforations can be distributed in a pre-designed pattern which can be a regular pattern, a staggered pattern, or other perforation patterns (see Figure 25). The

distance between each perforation can be, for example, between 10 nm to about 10 or about 20 times the perforation diameter. The perforations can also be conjoined, continuous, or in physical contact with each other, in any direction

[0051] In some embodiments, the electrode stack comprises a plurality of electrode layers or electrode plates. The electrode layers are arranged in a substantially parallel orientation such that the each perforation of an individual electrode layer is aligned along the alignment axis passing through the perforation of each of the electrode layers.

[0052] In cases where a battery core is included, the battery core may be wetted with liquid ionic electrolyte to be functional. Thus, the external skeleton encapsulating the battery core can be adapted to contain the liquid electrolyte within the cell.

[0053] In some embodiments one or more of the electrode layers can further be substituted with an inert material selected from the group consisting of metal, glass, ceramic, dielectric materials, steel or polymer plates containing identical or substantially identical perforation patterns for providing structural integrity to the electrode stack. Or in some embodiments, the electrode stack further comprise of a plurality of individual electrode stacks. The individual electrode stacks can further be separated by a layer or a plate of metal, glass, ceramic, dielectric materials, steel or polymer.

[0054] In some embodiments, rather than having the reinforcements disposed in the perforations or apertures of the stack of energy storage materials, the reinforcements themselves can comprise an array of perforations or apertures along an alignment axis parallel to the thickness direction, wherein one or more stacks of energy storage materials are arranged such that they extend a length along an alignment axis passing through the perforations in the reinforcements.

[0055] **Structural Facesheets.** Structural facesheets are thin structural layers on the outermost surface of the cell (either or both sides). This performs the structural function by providing rigidity to the MES Composites. The structural facesheets is usually a thin sheet made of structural materials. When more than one facesheets are included, the facesheets can be made of the same material or of different types of materials.

[0056] In some embodiments, the structural material is fiber-reinforced-polymers. Fiber-reinforced-polymers are polymers (matrix) that are reinforced with continuous or non-continuous fibers. Exemplary fibers include glass fibers, carbon fibers, wholly aromatic polyamide fibers (i.e., aramid fibers), polyester fibers, and natural fibers (e.g. cotton fibers).

Mixtures of different types of reinforcing fibers may also be employed. In some embodiments, the composite layer comprises woven fabric, unidirectional fibers, chopped fibers, and/or random strands of fibers. In some embodiments, the polymer matrix (which can be different from or the same as the polymer in the through-thickness reinforcements) can be thermosets due to their high elastic moduli and general temperature insensitivity, which include epoxy resins, phenolic resins, polyester resins, polyimide resins, polybenzimidazoles, polyurethanes, etc. In some embodiments, the polymer matrix can be thermoplastics, which include but not limited to, polyamides, polyoxymethylenes, polyolefins including polyethylene and polypropylene, thermoplastic polyesters, polyether ether ketone (PEEK), polyetherimide (PEI), polyethylene terephthalate (PET), etc..

[0057] Apart from fiber-reinforced-polymers, the structural facesheets can comprise at least one metal, (such as aluminum sheets, steel, iron, tungsten carbide, tungsten alloy, stainless steel, nickel, titanium, copper, brass, bronze, lead, tin, zinc, and/or other alloys), thermoset plastics (e.g., epoxy resins, phenolic resins, polyester resins, polyimide resins, polybenzimidazoles, polyurethanes, etc.), thermoplastics (e.g., polyamides, polyoxymethylenes, polyolefins including polyethylene and polypropylene, thermoplastic polyesters, polyether ether ketone (PEEK), polyetherimide (PEI), polyethylene terephthalate (PET), and their combinations or copolymers thereof etc.), ceramics (e.g. mixtures of alumina (Al₂O₃), silica (SiO₂), magnesia (MgO), zirconia (ZrO₂), chromium oxide (Cr₂O₃), iron oxide (Fe₂O₃), calcium oxide (CaO), silicon carbide (SiC), carbon (C)). In addition, in some embodiments, the reinforcements comprise a combination of the polymer, metal, and/or ceramic material described above.

[0058] In some embodiments, the structural facesheets further comprises a polymer coating (e.g., an electrolyte barrier layer) disposed on the surface. In some embodiments, the polymer coating comprises polyolefin (polyethylene or polypropylene), PTFE, polyester, nylon, polyamide, PVC, Polyether ether ketone (PEEK), polyetherimide (PEI), polyethylene terephthalate (PET), acrylonitrile butadiene styrene (ABS), and/or polyurethane and any copolymer of the above polymers (e.g. with functional groups such as acrylic acid, methacrylic acid, vinyl acetate, etc. with 0 -- 100% functional group weight percentage). Other polymers that have strong adhesion to the facesheets and are inert to battery chemistry can also be used in the polymer coating.

[0059] In some embodiments, the reinforcements and the polymer coating comprise at least one common material. In some embodiments, the reinforcements and the polymer

coating comprise the same material. The coating can be bonded to the surface of the structural facesheets by an intermediate adhesive layer, by fusing the same material, or by direct chemical bonding.

[0011] Similar to a sandwich structure construction, the stiff structural facesheets are thin structural plates placed on either or both sides of the electrode stack, separated by the stack thickness, to carry the bending moment. This increases the moment of inertia of the laminate, resulting in a higher bending rigidity. The structural facesheets can have a thickness of about 0 to about 20 millimeters, and have one or more lateral dimensions between 1 cm to 20 m.

[0012] Reinforcements. Through-thickness reinforcements can extend through the perforations in the electrode stack and mechanically link the two structural facesheets together, as shown in Figure 23.

[0013] The through-thickness reinforcements allow load transfer between the two facesheets and inhibit the relative slipping between the adjacent electrode layers. This significantly increases the stiffness and strength of the MES Composites over conventional electrochemical devices and batteries (for example, lithium ion batteries) as the entire laminate is able to bend about a common neutral axis.

[0014] In some embodiments, the reinforcements comprise a polyolefin class polymer (polyethylene, polypropylene, and copolymers thereof including ethylene co-methacrylic acid and ethylene co-acrylic acid, and ethylene co-vinyl acetate, etc.). The acid copolymers can be neutralized with zinc or sodium salts. In some embodiments, the polymer is selected from Teflon™, Delrin™, Kapton™, polytetrafluoroethylene (PTFE), perfluoroalkoxy (PFA), fluorinated ethylene propylene (FEP), polypropylene (PP), polyethylene (PE), Polyvinylidene fluoride (PVDF), polyether ether ketone (PEEK), polyetherimide (PEI), polyethylene terephthalate (PET), acrylonitrile butadiene styrene (ABS), polyester, polyamide, silicone and/or combinations thereof.

[0015] In some embodiments, the reinforcements comprise at least one fiber-reinforced polymer, wherein the fiber-reinforced polymer comprises fibers selected from the group consisting of carbon fibers, glass fibers, and aramid fibers, and wherein the polymer comprises a thermoset or thermoplastic.

[0016] In some embodiments, the reinforcements comprise at least one metal, such as aluminum sheets, steel, iron, tungsten carbide, tungsten alloy, stainless steel, nickel, titanium, copper, brass, bronze, lead, tin, zinc, and/or other alloys. In some embodiments, the

reinforcements comprise at least one ceramic material, such as aluminum oxide, silicon carbide, and/or silicon oxide. In addition, in some embodiments, the reinforcements comprise a combination of the polymer, metal, and/or ceramic material described above.

[0066] In some embodiments, the reinforcements comprise the composites of at least one of the above materials with at least one of the following additives: plastics, ceramics, firebrick, refractory material, castable refractories, refractory brick, mixtures of alumina (Al_2O_3), silica (SiO_2), magnesia (MgO), zirconia (ZrO_2), chromium oxide (Cr_2O_3), iron oxide (Fe_2O_3), calcium oxide (CaO), silicon carbide (SiC), carbon (C), metallic materials, plain carbon steels, alloy steels, manganese, silicon, nickel, chromium, molybdenum, tungsten, cobalt, etc.

[0067] The reinforcements can be made with a variety of geometries and physical dimensions. The reinforcements are generally cylindrical in shape. The diameter of the pillars can be from 0.5 mm up to 20 mm or more. The height of these cylinders basically is the thickness of the electrode stack. The cross section of the polymer pillars do not have to be circular, e.g., they do not have to be cylindrical in shape, and can have other polygonal or non-polygonal shapes. Example cross-sections of the reinforcements are shown in Figures 25-27. Optionally, the dimensions of each reinforcement structure can be identical, substantially identical, or independent.

[0068] Either end of the reinforcements (in the thickness direction) can be bonded to the inside surface of the structural facesheets (or on the coating of the facesheets), by an intermediate adhesive layer, by fusing the same material, or by direct chemical bonding. The bonding between the reinforcements and the facesheets allow load transfer between the two facesheets, and the presence of the reinforcements anchors the electrode layers, resulting in an increase in the stiffness and strength of the complete device.

[0069] In some embodiments of the invention, rather than having the reinforcements disposed in the perforations or apertures of the stack of energy storage materials, the reinforcements themselves can comprise an array of openings, perforations or apertures, wherein one or more stacks of energy storage materials are arranged or disposed inside those openings.

[0070] The reinforcements can also be hollow or concentric, such as a thin-walled cylinder instead of a solid cylinder. Through the aperture in hollow reinforcements, multifunctionalities can be added, including (a) electrolyte filling, (b) thermal management and communication, through a heat sink or a heat source to control the temperature, (c) filling

of actuator or transducer materials, which can be deformed according to changed shapes of the reinforcements, (d) sensors to monitor the state of batteries (such as pressure, temperature, etc.), and/or (e) cables or conduits for signal transmissions, electrical conduction, etc.

[0071] In some embodiments, one or more reinforcements further contain a thermal device (see Figure 30A), such as a heat sink or a heat source, or a heat pipe, or heat transfer rods arranged such that each heat transfer rod extends a length along an alignment axis passing through the perforations in the electrode stack, and wherein the heat transfer rods are positioned in thermal communication with a heat sink or a heat source.

[0072] In some embodiments, one or more reinforcements further contain a dielectric or an inert coating on a surface (see Figure 30B), thereby preventing a reaction from occurring at the reinforcements.

[0073] In some embodiments, one or more reinforcements further comprises a group of reinforcements (see Figure 30C), wherein the group of reinforcements are arranged such that they extend a length along an alignment axis passing through the perforations in the electrode stack.

[0074] In some embodiments, one or more reinforcements further comprise of a porous rod; or wherein one or more reinforcements comprises a hollow rod with porous walls (see Figure 30D); or wherein the reinforcements are a plurality of tubes arranged along an alignment axis passing through the perforations in the electrode stack.

[0075] In some embodiments, one or more porous reinforcements; or the interior of one or more hollow reinforcements; or within each tube is filled with: a fluid, a liquid electrolyte, a fuel fluid, an aqueous solution, a gas (such as oxygen), a thermal-management substance, etc. The fluid, liquid electrolyte, aqueous solution or gas flows through the porosity, the interior, or through the tubes along an alignment axis passing through the perforations in the electrode stack.

[0076] In some embodiments, one or more reinforcements further comprises of actuator or transducer materials or devices consisting of at least a device selected from the group consisting of: electromagnetic devices, electrochemical devices, electromechanical devices, electroacoustic devices, electrostatic devices, thermoelectric devices, and radio acoustic devices.

[0077] In some embodiments, one or more reinforcements further comprises of cables of conduits for electrical signal transmission and electrical conduction (see Figure 30E).

[0078] In some embodiments, one or more reinforcements further comprises on at least one sensor selected from the group consisting of: strain gauges, thermocouples, thermistors, pressure sensors, tactile sensors, piezoelectric sensors, voltage sensors, current sensors, humidity sensors, etc.

[0079] **Reinforcement Frame/Edge-Filling Frame.** In some embodiments, MES composite can further comprise an edge-filling frame, as shown in Figure 23. The edge-filling frame encapsulates the battery core and the liquid electrolyte in the lateral direction. It prevents the electrolyte from escaping through the edges. Also the edge-filling frame enhances the mechanical properties by constraining the edges of the MES composite cells.

[0080] In some embodiments, the edge-filling frame comprises a polyolefin class polymer (polyethylene, polypropylene, and copolymers thereof), including ethylene co-methacrylic acid and ethylene co-acrylic acid, and ethylene co-vinyl acetate. The acid copolymers can be neutralized with zinc or sodium salts. In some embodiments, the polymer is selected from Teflon, Delrin, Kapton, polytetrafluoroethylene (PTFE), perfluoroalkoxy (PFA), fluorinated ethylene propylene (FEP), polypropylene (PP), polyethylene (PE), polyvinylidene fluoride (PVDF), polyether ether ketone (PEEK), polyetherimide (PEI), polyethylene terephthalate (PET), acrylonitrile butadiene styrene (ABS), polyester, polyamide, silicone and/or their combinations or copolymers thereof.

[0081] In some embodiments, the edge-filling frame comprises the composites of at least one of the above polymers with at least one of the following additives: plastics, ceramics, firebrick, refractory material, castable refractories, refractory brick, mixtures of alumina (Al_2O_3), silica (SiO_2), magnesia (MgO), zirconia (ZrO_2), chromium oxide (Cr_2O_3), iron oxide (Fe_2O_3), calcium oxide (CaO), silicon carbide (SiC), carbon (C), metallic materials, plain carbon steels, alloy steels, manganese, silicon, nickel, chromium, molybdenum, tungsten, cobalt, etc.

[0082] **Polymer Coating/Electrolyte Barrier Layer.** In some embodiments, the structural facesheets further comprises a thin electrolyte barrier layer disposed on the surface, as shown in Figure 23, though the MES composite can be made without an electrolyte barrier layer. Specifically, if the facesheet has the following characteristics of the barrier layer, the electrolyte barrier layer can be omitted.

[0083] In some embodiments, the electrolyte barrier layer is essentially a thin sheet of an insulating, inert material, preferably of the same polymer type as the reinforcements, bonded to the inside surface of the facesheet (the side facing the battery core). This thin sheet serves as (a) a barrier to prevent the electrolyte from escaping in the thickness direction; (b) a mechanical link between the facesheet and the reinforcements – because this sheet rigidly bonds to the facesheet and it is the same type of material as the reinforcements, they can be melt-bonded altogether. Optionally, the electrolyte barrier layer can be bonded to the surface of the structural facesheets by an intermediate adhesive layer, by fusing the same material, or by direct chemical bonding.

[0084] In some embodiments, the electrolyte barrier layer comprises a polyolefin class polymer (polyethylene, polypropylene, and copolymers thereof), including ethylene co-methacrylic acid and ethylene co-acrylic acid, and ethylene co-vinyl acetate. The acid copolymers can be neutralized with zinc or sodium salts. In some embodiments, the polymer is selected from Teflon, Delrin, Kapton, polytetrafluoroethylene (PTFE), perfluoroalkoxy (PFA), fluorinated ethylene propylene (FEP), polypropylene (PP), polyethylene (PE), polyvinylidene fluoride (PVDF), polyether ether ketone (PEEK), polyetherimide (PEI), polyethylene terephthalate (PET), acrylonitrile butadiene styrene (ABS), polyester, polyamide, silicone and/or their combinations or copolymers thereof.

[0085] In some embodiments, the electrolyte barrier layer comprises the composites of at least one of the above polymers with at least one of the following additives: plastics, ceramics, firebrick, refractory material, castable refractories, refractory brick, mixtures of alumina (Al_2O_3), silica (SiO_2), magnesia (MgO), zirconia (ZrO_2), chromium oxide (Cr_2O_3), iron oxide (Fe_2O_3), calcium oxide (CaO), silicon carbide (SiC), carbon (C), metallic materials, plain carbon steels, alloy steels, manganese, silicon, nickel, chromium, molybdenum, tungsten, cobalt, etc.

[0086] **Assembling the MES Composite.** The MES composite can be assembled by first providing an electrode stack, wherein the electrode stack includes an array of perforations or apertures. In case the electrode stack comprises a plurality of electrode plates, the plurality of the electrode layers can be arranged in a substantially parallel orientation such that each perforation of an individual electrode layer is aligned along an alignment axis passing through a perforation of each of all other electrode layers. Second, one or more reinforcements can be provided and arranged such that each reinforcement extends a length along an alignment axis passing through a perforation in the electrode stack. Third, structural

facesheets can be provided and arranged to sandwich the electrode stack, wherein the structural facesheets are attached to the ends of the reinforcements.

[0087] Non-limiting processes for assembling the MES composites are provided in the working examples.

[0088] **Applications of the MES composite.** Another aspect of some embodiments the invention relates to the use of the MES composite as a structural component for an electrical device or an electric system.

[0089] Structural components integrated with the MES composite described herein can also be used in a multitude of applications, such as construction, aerospace applications, aircraft, maritime, and other energy-related industries.

[0090] In one non-limiting example, the MES composite is incorporated in a structural component (e.g., chassis) of an electric vehicle. In some embodiments, the electric vehicle is an automobile. In some embodiments, the electric vehicle is an unmanned aerial vehicle. Multifunctional energy storage designs help reduce the effective weight of an EV energy storage system. If the vehicle level specific energy requirements are assumed to be the same, the reduction in protection/control overhead with the multifunctional battery relaxes the need for a high cell level specific energy. The weight reduction comes from the fact that the structural members of an electric vehicle, protective elements such as protections for battery cells, and the battery can be replaced with the multifunctional battery. The saving can be calculated by comparing the total weight of the structural members, protective elements, and batteries of a conventional EV to the weight of the multifunctional battery. In this case, the multifunctional battery is scaled so that it can perform a same or similar structural function and stores a same or similar energy as that in a conventional EV.

[0091] In some embodiments, the electric device or electric system further comprises one or more thermal management modules. In some embodiments, the thermal management modules comprise liquid for thermal management. In some embodiments, the thermal management modules comprise air flow for thermal management. In some embodiments, the thermal management modules comprise phase-changing materials for thermal management.

[0092] In some embodiments of the electric device or electric system, the MES composites and the thermal management modules are anchored perpendicularly on at least one mounting panel. In some embodiments, the MES composites and the thermal management modules can be parallel to each other. In some embodiments, the mounting panel comprises a

plurality of T-shaped joints for anchoring the MES composites and the thermal management modules. In some embodiments, the T-shaped joints comprise CFRP materials.

[0093] In some embodiments, the electric device or electric system further comprises at least one sensor. In some embodiments, the electric device or electric system comprises a piezoelectric sensor for impact detection. In some embodiments, the electric device or electric system comprises a temperature sensor for monitoring battery temperature. In some embodiments, the electric device or electric system comprises an electrical sensor for monitoring electrical connection.

[0094] As will be understood by one of skill in the art, the figures provided are illustrative of embodiments of the invention. Unless otherwise indicated, the dimensions shown in the figures are not intended to be to scale. Orientations of embodiments shown include both horizontal and vertical orientations. That is, although the figure may show one orientation, other orientations (e.g., rotated 0 – 360°) are also included.

[0095] **Additional Non-Limiting Embodiments.** Embodiment 1 – A multifunctional energy storage (MES) composite comprising (a) a stack of energy storage materials and (b) one or more structural facesheets sandwiching the stack of energy storage materials, wherein the stack of energy storage materials is perforated by and anchored on (c) one or more reinforcements, and wherein the structural facesheets comprise a composite layer and optionally a polymer coating disposed on the composite layer.

[0096] Embodiment 2 – A MES composite comprising (a) a stack of energy storage materials, (b) one or more structural facesheets sandwiching the stack of energy storage materials, and (c) one or more reinforcements perforated by the stack of energy storage materials, and wherein the structural facesheets comprise a composite layer and optionally a polymer coating disposed on the composite layer.

[0097] Embodiment 3 – The MES composite of Embodiment 1 or 2, wherein the structural facesheets comprise a carbon-fiber-reinforced-polymer (CFRP) layer as the composite layer.

[0098] Embodiment 4 – The MES composite of Embodiment 3, wherein the CFRP layer comprises woven carbon fabric.

[0099] Embodiment 5 – The MES composite of Embodiment 3, wherein the CFRP layer comprises epoxy resin.

[0100] Embodiment 6 – The MES composite of Embodiment 5, wherein the epoxy resin is obtained by reacting diglycidyl ether of bisphenol A with triethyltetramine.

[0101] Embodiment 7 – The MES composite of Embodiment 1 or 2, wherein the facesheets, apart from comprising a composite layer, can comprise at least one material selected from the group consisting of metals, metal alloys, thermoset plastics, and thermoplastics.

[0102] Embodiment 8 – The MES composite of Embodiment 1 or 2, wherein the polymer coating comprises at least one polymer selected from the group consisting of polyolefin (e.g. polyethylene, polypropylene, and copolymers such as poly(ethylene-co-methacrylic acid), , poly(ethylene-co-vinyl acetate), or poly(ethylene-co-acrylic acid)), polytetrafluoroethylene (Teflon), polyoxymethylene (Delrin), poly-oxydiphenylene-pyromellitimide (Kapton), perfluoroalkoxy, fluorinated ethylene propylene, polyvinylidene fluoride, polyetherimide, polyether ether ketone, polyethylene terephthalate, polyester, polyamide, silicone, co-polymers of the above and/or combinations thereof.

[0103] Embodiment 9 – The MES composite of Embodiment 8, wherein the polymer coating comprises a composite of the polymer and at least one additive, wherein the additive is selected from the group consisting of plastics, ceramics, firebrick, refractory material, carbon, silicon, silica, silicon carbide, metals, metal oxides, and metal alloys .

[0104] Embodiment 10 – The MES composite of Embodiment 1 or 2, wherein the reinforcements comprise at least one polymer selected from the group consisting of polyolefin (e.g. polyethylene, polypropylene, and copolymers such as poly(ethylene-co-methacrylic acid), , poly(ethylene-co-vinyl acetate), or poly(ethylene-co-acrylic acid)), polytetrafluoroethylene (Teflon), polyoxymethylene (Delrin), poly-oxydiphenylene-pyromellitimide (Kapton), perfluoroalkoxy, fluorinated ethylene propylene, polyvinylidene fluoride, polyetherimide, polyether ether ketone, polyethylene terephthalate, polyester, polyamide, silicone, co-polymers of the above and/or combinations thereof.

[0105] Embodiment 11 – The MES composite of Embodiment 10, wherein the reinforcements comprise a composite of the polymer and at least one additive, wherein the additive is selected from the group consisting of plastics, ceramics, firebrick, refractory material, carbon, silicon, silica, silicon carbide, metals, metal oxides, and metal alloys.

[0106] Embodiment 12 – The MES composite of Embodiment 1 or 2, wherein the reinforcements and the polymer coating comprise at least one common polymer, and wherein the reinforcements are fused to the polymer coating.

[0107] Embodiment 13 – The MES composite of Embodiment 1 or 2, where the energy storage materials comprise lithium-ion batteries.

[0108] Embodiment 14 – The MES composite of Embodiment 1 or 2, where the energy storage materials optionally comprise a electrochemical cells such as a primary cell, a secondary cell (including a lithium cell, a lithium ion cell, a lead-acid cell, a zinc-carbon cell, an alkaline cell, a nickel-cadmium cell, a nickel metal hydride cell, a silver oxide cell, a sodium sulfur cell, etc.), a solid electrochemical cell, a fluid electrochemical cell, a flow battery, a fuel cell, a capacitor, a supercapacitor, a semi-solid battery, and a metal-air battery.

[0109] Embodiment 15 – The MES composite of Embodiment 1 or 2, further comprising a reinforcement frame disposed along the lateral perimeter of the stack.

[0110] Embodiment 16 – The MES composite of Embodiment 15, wherein the reinforcement frame, reinforcements and the polymer coating (or the facesheets themselves) comprise at least one common polymer, and wherein the reinforcements are fused to the polymer coating (or the facesheets themselves).

[0111] Embodiment 17 – The MES composite of Embodiment 15, wherein the reinforcement frame, the polymer coating, the reinforcements, and facesheets are bonded by an intermediate adhesive layer, by fusing the same material, or by direct chemical bonding.

[0112] Embodiment 18 – An energy storage device comprising the MES composite of any of Embodiments 1-17.

WORKING EXAMPLES

[0113] **Example 1 – MES Composite Li-ion Cells.**

[0114] State-of-the-art automotive Li-ion pouch cells contain a stack of thin anode and cathode layers, arranged in an alternating fashion. Each adjacent electrode pair is separated by a thin polymer separator membrane (Figure 11a). The stack is packaged in a thin aluminum-polymer-laminate pouch, filled with organic liquid electrolyte, and vacuum-sealed. The individual layers are loose, i.e. mechanical linkage is not present between the layers. Thus load transfer through the cells is minimal if any. Conventional Li-ion pouch batteries

are not designed to carry mechanical loads, which might cause excessive relative sliding between the layers and short-circuit the cell.

[0115] The MES Composite Li-ion cells encapsulates lithium-ion battery materials inside structural carbon-fiber-reinforced-polymers (CFRP) ‘facesheets’ (Figure 11b). The energy-storage component of the MES Composites is standard automotive Li-ion battery active materials. Instead of using the standard aluminum-laminate packaging, the MES Composites also uses the CFRP facesheets to contain the electrodes and the liquid electrolyte.

[0116] Similar to a sandwich structure construction, the stiff, structural CFRP facesheets are placed on either side of the electrode stack, separated by the stack thickness, to carry the bending moment. This increases the moment of inertia of the laminate, resulting in a higher bending rigidity. However, without the interlayer shear resistance of the battery core, the thin battery layers will bend about their own individual neutral axis, and the structural contribution from the facesheets will be minimal.

[0117] The MES Composites use through-thickness polymer reinforcements, which extend through the perforations in the electrode stack and mechanically link the two structural CFRP facesheets on either side together. The through-thickness reinforcements allow load transfer between the two facesheets and inhibit the relative slipping between the adjacent electrode layers. This significantly increases the stiffness and strength of the MES Composites over regular lithium-ion batteries as the entire laminate is able to bend about a common neutral axis.

[0118] The MES Composites are capable of simultaneously providing a high mechanical load-carrying capability, as well as storing electrical energy. By permitting the two materials to be mutually beneficial and become multifunctional, weight and volume of the MES-Composites-powered devices can be minimized.

[0119] **Example 1.1 – Fabrication of MES Composite Li-ion Cells.**

[0120] An MES Composite li-ion cell comprises the following three main components: the core battery electrode stack, the CFRP facesheets, and the polymer reinforcements.

[0121] **Electrode Stack.** The battery core is constructed from a stack of alternating anode and cathode layers, with each adjacent layer separated by a thin microporous polymer separator. Conventional production active materials were used for the cathode and the anode, which were Lithium Nickel-Cobalt-Manganese (NCM) and graphite respectively. All the

sample types used 11 anode and 10 cathode layers – the external electrode dimensions measured 90mm x 90mm.

[0122] The electrodes were cut and perforated at the locations where the through-thickness reinforcements will be placed, prior to lamination. The patterns of the through-thickness reinforcement array for the different sample types are shown in Figure 13, for anode. A separate design for the cathode was made such that the anode coverage is slightly larger than the cathode (0.5 mm in every direction) to ensure that excess anode was present and reduce the possibility of shorting. After stacking, the separators were spot-melted to bridge the through-thickness holes. The cathode's copper current collectors were ultrasonically welded together onto a nickel tab, and similarly for the anode's aluminum current collectors using an aluminum tab.

[0123] The thickness of the complete electrode stack measured approximately 3.5 mm. For Sample A, the stack was then pouched in a standard aluminum-laminate packaging. For Samples B, C, and D, the electrode was subsequently encapsulated in the CFRP facesheets, as will be described.

[0124] CFRP Facesheet. Dry 3K 2x2-Twill T300 carbon fiber fabric was used in a vacuum-assisted resin infusion process to fabricate the CFRP facesheets. Three carbon fiber layers ([0,90] orientation) were infused with the unmodified liquid epoxy system (Bisphenol A diglycidyl ether (DGEBA) + Triethylene tetramine (TETA) (stoichiometric)). The laminate was then cured at room temperature for 24 hours, followed by a post-cure at 90°C for 30 minutes. A thin layer (150 microns thick) of a polyolefin copolymer, which is the same type of polymer as that of the reinforcements, is coated onto one side of the facesheets. The thin polymer layer serves to contain the liquid electrolyte within the electrode stack; helps bond the facesheet to the reinforcement pillars and edge-filling frame; and provides an inert surface coating for the structural facesheets. The laminate was then cut into 110mm x 160mm facesheet pieces.

[0125] Polymer Reinforcements and Assembly. An edge-filling polymer frame is cut from a 3.5mm-thick sheet of the same thermoplastic polyolefin polymer, into the dimensions as shown in Figure 14. An opening is made in order to be able to put the electrode stack in the middle. The frame serves to contain the electrolyte within the electrode stack core, and also enhances the mechanical performance of the MES Composite li-ion cells. The frame width of 10 mm in this case is more than sufficient for electrolyte containment. The length of

the frame (and CFRP facesheets) was designed to be 160 mm to allow for 30 mm overhangs in a three-point-bending test, as will be discussed further.

[0126] The perforations in the electrode stack were then filled with thermoplastic polymer cylindrical plugs, placed inside the opening of the edge-filling polymer frame, and sandwiched between two facesheets (Figure 14). The assembly was hot-pressed to melt and fuse the polymer reinforcements to the facesheets. The cell was filled with a standard Li-salt electrolyte (LiPF₆ in EC/DMC/DEC organic solvent), edge-sealed, formed, degassed, and re-sealed. It should be noted that even without the standard Li-ion battery pouch, the cell could subsequently undergo a standard cell fabrication process, as the facesheets and the polymer frame serve as the cell enclosure.

[0127] As a separate screening experiment to test the permeability of the electrolyte through the polymers, cathode electrodes were coated with a thin layer of the polymer and flooded beaker cells with lithium metal counters electrodes were assembled. In all cases the flooded beaker cell showed an open circuit even after leaving the coated cathodes soaking for one week, suggesting that the coating polymer layers would serve as good barriers against electrolyte diffusion, thereby protecting the encapsulating epoxy.

[0128] Another separate experiment evaluates the compatibility between the polymer used for the reinforcements and the epoxy in the structural facesheets in the presence of the LiPF₆ electrolyte. The compatibility study consisted of storing the polymer in the presence of the battery electrolyte at room temperature and at 45 °C in a glove box while monitoring for any polymer dissolution, swelling, and reactivity. The polymer showed no significant change in the presence of the electrolyte making them compatible materials for integration into the new polymer rivet cell designs.

[0129] **Example 1.2 – Experimental Characterization.**

[0130] Four types of samples were fabricated and tested electrochemically and mechanically in this example, as summarized in Table 1.

Table 1. Sample Types and Description

Sample Type	Sample Description	Electrochemical Characterization	Mechanical Testing	Dimensions & Weight
A	Al-laminate packaging No perforations	✓		90x90x3.5 mm 81±1 g
B	MES Composite No perforations		✓	160x110x5 mm (110x110x5 mm – functional) 120±5 g
C	MES Composite 4x4 perforation array	✓	✓	160x110x5 mm (110x110x5 mm – functional) 120±5 g
D	MES Composite 5x5 perforation array	✓	✓	160x110x5 mm (110x110x5 mm – functional) 120±5 g

[0131] The Sample A (Figure 12 (Top)) was essentially a standard 4.6Ah Li-ion pouch cell, encapsulated in a conventional aluminum-laminate packaging. Its purpose was to serve as a baseline for electrochemical characterization. Mechanical testing was not performed on this sample type, as discussed in the subsequent section.

[0132] Samples B, C, and D (Figure 12 (Bottom)) were MES Composites, with Li-ion battery active materials encapsulated in CFRP facesheets. All of them except Sample B underwent both electrochemical characterization and mechanical testing. The difference between Samples B, C and D was the density of the through-thickness reinforcement array. Sample B did not have any through-thickness reinforcements, while Samples C and D contained 4x4 and 5x5 arrays of equally-spaced cylindrical reinforcements respectively (Figure 13). The active electrode stack for all sample types includes 11 and 10 90x90mm double-sided anode and cathode layers respectively.

[0133] **Electrochemical Characterization.** The MES Composites had a thorough electrochemical feasibility characterization, namely cell capacity, cell impedance, and cycle life performance, as its construction significantly differs from that of a conventional Li-ion cell.

[0134] After a solid electrolyte interphase (SEI) formation step, the Samples A, C and D were first subject to an initial slow-rate charge-discharge cycle between 3.0V and 4.2V, where the testing protocol was calibrated to obtain the C-rate (1C-rate is the rate at which the battery will be fully charged or discharged in 1 hour).

[0135] The samples then underwent the initial electrochemical Reference Performance Test (RPT). The cells were cycled at a C/3 (3 hours to fully charge or discharge the cell) rate, or approximately at 1300 mA. At the beginning of life (BOL) of each sample, the cell DC impedance was also measured. The test was performed using a Hybrid Pulse Power Characterization (HPPC) test profile during the first C/3 discharge. The technique evaluates the cell DC impedance at every 10% of Depth of Discharge (DoD) by measuring the voltage difference during the current interruption.

[0136] The C/3 charge-discharge cycle was repeated to compare the retention of discharge capacity with increasing number of cycles between the different samples types.

[0137] **Mechanical Testing.** A flexural (three-point bending) test was performed on Samples B, C, and D after the initial electrochemical RPT, to evaluate the mechanical feasibility of the MES Composites. The interlayer-shear inhibition capability of the through-thickness reinforcements could be validated through measuring and comparing the sample's bending rigidity.

[0138] Testing was performed on a three-point bending fixture with cylindrical-roller load applicator and supports using a 100mm span, on an MTS test system (Figure 15). The span allowed for an overhang of 30 mm on either side of the samples (lengthwise direction). The support span was approximately 20 times the depth, which was sufficient to avoid significant influence from transverse shear. The displacement at the mid-span was constantly measured while the crosshead was displaced at the rate of 0.127 mm/mm/min (quasi-static). The bending rigidity can be determined from the slope of the load-displacement curve using Equation 1.

$$EI = \frac{L^3}{48} \frac{dP}{d\delta_p} \quad (1)$$

[0139] Where EI is the effective bending rigidity, L is the support span, and dP/dδP is the slope of the load-displacement curve, in which P is the load and δP is the resulting mid-span displacement.

[0140] The mechanical testing was interrupted when the mid-span deflection reached 1mm. After that, the sample was removed from the mechanical test machine, and a sequential electrochemical RPT was performed. The test was then repeated for a mid-span deflection of 2 mm.

[0141] The discharge curves, discharge capacity, and DC impedance before loading (pristine sample condition) could be compared with the results after mechanical load has been applied. This serves to indicate any non-fatal degradation in the battery performance due to mechanical loading.

[0142] **Example 1.3 – Experimental Results.**

[0143] **Electrochemical Characterization.** Figure 16 presents the voltage and current history with time of a nominal C/3 cycle of a typical MES Composite Sample C, showing the typical characteristics of the graphite/NMC chemistry. The charge-discharge current was 1300 mA (approximately C/3).

[0144] The first discharge capacity was summarized in Table 2, for the MES Composite cells (Samples C and D) and the control Sample A, in comparison with the theoretical values. The theoretical capacity of each cell type can be calculated from the active material loading and the remaining surface area after perforation.

Table 2. Summary of first discharge capacity, in comparison with the theoretical capacity calculated from the added amount of active materials

Sample Type	Sample Description	Active Surface Area per Layer	Theoretical Capacity	Measured First Discharge Capacity
A	Al-laminate packaging No perforations	7921 mm ² (100%)	4602 mAh (100%)	4602 mAh (100%)
C	MES Composite 4x4 perforation array	7469 mm ² (94.3%)	4340 mAh (94.3%)	4243 mAh (92.2%)
D	MES Composite 5x5 perforation array	7215 mm ² (91.1%)	4192 mAh (91.1%)	3974 mAh (86.4%)

[0145] As expected, the first discharge capacity of the MES Composite cells decreased as the loss of area increased due to the perforations in Samples C and D respectively. The active

surface area in Sample C was 94.3% of that in Sample A due to the 4-by-4 perforations, and 91.1% for the case of Sample D.

[0146] Yet, it can be observed that the measured first discharge capacity of the MES cells were marginally lower than the predicted values (2.1% for Sample C and 4.7% for Sample D), but still within an acceptable extent. The discrepancies were thought to be linked partly to the slightly higher DC impedance in the MES Composites, shown in Figure 17. At 50% DoD, the DC impedance of Sample A (baseline) was 23 m Ω , whereas the impedance was measured to be approximately 31 m Ω for Samples C and D, approximately 35% higher.

[0147] The capacity hit and high impedance were likely due to the perforations and the non-standard cell build. The perforated electrodes in MES Composite Samples C and D have more free edges (holes edges) than the non-perforated Sample A. Imperfections from electrode cutting, such as edge burrs and active material flaking, would be more pronounced for the perforated electrodes. Also, with more free edges than a regular cell, slight misalignment between adjacent anode-cathode pairs can cause a greater loss in the actual active surface area, resulting in a reduction in cell capacity. The high-temperature, high-pressure assembly process might also cause the electrode layers and separator to deform or wrinkle, and impair the ionic pathway. Lastly, there might also be a negative impact on the electrochemistry and thus the cell capacity from the presence of the facesheet and polymer reinforcement materials.

[0148] Figure 18 shows the C/3-cycle capacity retention with increasing cycle number of the MES Composites Samples C and D, in comparison with the baseline Sample A. The capacity retention of the MES Composites, with respect to the initial discharge capacity, was found to be approximately 96% after 200 cycles, similar to the cycle-life performance of the baseline cell. The capacity fade of MES Composites is on par with commercial-grade production Li-ion batteries, despite of substantial deviation in the architecture and fabrication from conventional Li-ion pouch cells.

[0149] In summary, the electrochemical characterization has shown that a working MES Composite can be successfully fabricated and has electrochemical capability that is comparable to conventional Li-ion batteries.

[0150] **Mechanical Testing.** The typical load versus mid-span displacement curves for the three point bending of Samples B, C, and D are shown in Figure 19. The curves were found to be linear up to the maximum deflection (2 mm) applied during this experiment, and the

slope values were repeatable for the different load-unload instances. The slope values were calculated through linear regression on the load-displacement data in the 0 – 0.5 mm deflection region. The “effective” bending rigidity was then found using Equation 1, and summarized in Table 3.

Table 3. Summary of load-displacement slopes (load per unit mid-span displacement) and calculated effective bending rigidity

Sample Type	Sample Description	Load-displacement Slope	Effective Bending Rigidity
B	MES Composites No perforations	118 ± 10 N/mm	2.5 ± 0.3 Nm ²
C	MES Composite 4x4 perforation array	530 ± 7 N/mm	11.0 ± 2.0 Nm ²
D	MES Composite 5x5 perforation array	580 ± 20 N/mm	12.1 ± 0.7 Nm ²

[0151] It can be seen that the effective stiffness of Sample C (4x4 MES cell) was 11.0 Nm², which was as high as 4.4 times that of Sample B (non-perforated MES cell) at 2.5 Nm². The significant increase in rigidity can be attributed to the presence of the through-thickness reinforcements that effectively prevent the sliding motion between the layers and allow load transfer between the two facesheets. The bending rigidity ratio increased to 4.8 for Sample D, as the reinforcement array density increased to 5-by-5. Intuitively, the denser the reinforcement array, the greater the bending rigidity becomes. However, this comes with trade-off in the reduction of active material volume, and consequently lower energy density.

[0152] Figure 20 shows the C/3 discharge voltage time-history of Sample D before loading (pristine), and after mid-span bending deflection of 1 mm (corresponding load of 530 N), and 2 mm (1160 N) respectively. Similarly to Sample B and C, there is a slight deviation in the discharge time history with increase in mechanical load levels.

[0153] The normalized C/3 discharge capacity and cell impedance (at 50% DoD) after exposure to the incremental quasi-static loads are shown in Figure 21 and Figure 22 respectively. The results after load application were normalized, in terms of percentage, with the values at pristine condition (100% - leftmost column of each cluster). This concurs with

the results in the discharge curves - that is, no clear trend could be seen in the capacity and cell impedance results with increasing loading.

[0154] Up to the maximum mid-span deflection (2 mm over 100 mm span) in this test, no observable degradation due to the quasi-static load could be seen in the MES Composites. Moreover, it is worth noting that, at the same level of deflection (2 mm over 100 mm span), the load carrying capability has increased from 235N to 1060N, and 1160N, for the non-perforated, 4x4, and 5x5 MES cells respectively. This illustrates that the CFRP encapsulation and through-thickness reinforcement are capable of maintaining the integrity of the battery and the electrical connection and preventing non-fatal electrochemical injury that could have come from mechanical loads.

[0155] **Summary of Figures of Merits.** The summary of the figures of merit of the different sample types is shown in Table 4. The C/3 discharge capacity for Sample A is 4.602 Ah. At a nominal cell voltage of 3.7 V, the cell energy thus becomes 17.0 Wh. Sample A weighs 81 g, and has the total volume of 28.4 mL, resulting in the gravimetric and volumetric energy density of 210 Wh/kg and 599 Wh/L respectively. Similar calculations can be carried out for Samples B, C, and D, and summarized in Table 4.

Table 4. Summary of Figures of Merits

Sample Type	Sample Description	Bending Rigidity	Gravimetric Energy Density	Volumetric Energy Density
A	Al-laminate packaging No perforations	(0.6 Nm ² *)	210 Wh/kg	599 Wh/L
B	MES Composite No perforations	2.5 Nm ²	142 Wh/kg	281 Wh/L
C	MES Composite 4x4 perforation array	11.0 Nm ²	131 Wh/kg	259 Wh/L
D	MES Composite 5x5 perforation array	12.1 Nm ²	123 Wh/kg	243 Wh/L

* Estimated from published values and adjusted for the difference in the cross-section geometry and moment of inertia.

[0156] By adopting the MES Composite concept to Li-ion battery materials, a cell with bending rigidity close to as much as 20 times higher than that of a regular pouch cell was

obtained. This comes with approximately 40% and 60% sacrifice in the gravimetric and volumetric energy density. Even though, the energy storage performance might be sub-optimal if considered individually, structural components at the system level can be replaced with the multifunctional MES Composites, potentially resulting in the system-level weight and space savings.

[0157] It has been shown that the MES Composites can concurrently carry mechanical loads and store energy. The MES Composites utilizes through-thickness polymer reinforcement pillars that penetrate through perforations in the Li-ion battery electrode stack. The through-thickness reinforcements provide substantial mechanical integrity to the cell by rigidly linking the structural CFRP facesheets on either side, which also serves as a containment for the electrolyte. The results have illustrated that: (a) despite being vastly different from a standard Li-ion pouch cell, the MES Composites shows electrochemical performance, which is on par with traditional batteries; (b) the through-thickness reinforcements significantly increases the bending rigidity by effectively preventing relative shearing of the electrode layers, allowing the structural facesheets to be efficiently utilized; and (c) the architecture of the MES Composites also helps keep the active electrochemical materials inside the cell intact under mechanical loads. At the maximum bending deformation (2 mm over 10 cm span) tested, the best performing MES Composite can carry up to 1160N of bending load without observable degradation on electrochemical performance.

[0158] The MES Composites can simultaneously function as both an energy storage as well as a load-carry member. The MES Composites can serve as a building-block material that can be scaled up to build structural components, with built-in energy-storage capability, for various application, and potentially resulting in a light-weight multifunctional system.

[0149] Example 2 -- Use of Plurality of MES Composite Cells for Structural Components.

[0159] To demonstrate the concept of integrating MES Composites into actual structural components, a 10"-long, 2"-tall multifunctional multi-cell structural I-beam was constructed. Three 0.46-Ah li-ion cells were used in this working example. The cells comprise 11 anode and 10 cathode layers were built – the electrode geometry measured 1.71"×1.22" with four 0.4"-diameter perforations. Conventional production active materials are used for the cathode and the anode, which are lithium-NCM and graphite respectively, separated by layers of polyolefin separator. Separate designs for the cathode and anode were made with anode

coverage larger than the cathode to ensure that excess anode is present and reduce the possibility of shorting. The quantity of active material included in each cell theoretically amounted to a capacity of 0.46 Ah.

[0160] The I-beam comprised the MES Composite with the three 0.46-Ah Li-ion cells, connected in series (3S1P configuration), in a configuration shown in Figure 29. The complete beam had a nominal voltage of 11.1 V, and a total theoretical energy of 5.1 Wh. To connect the three separate cells in the module, the current collector foils of one cell's cathode were ultrasonically welded to the anode current collector of the adjacent cell, through a nickel tab. The positive and negative terminals extended out from either end of the I-beam. The electrical conductivity of the MES Composite module could be measured prior to addition of electrolyte (while the cell is dry) in order to ensure proper connection between the modules of the I-beam. Two CFRP C-beams (each making half of the I-beam) were made with the aforementioned wet-layup process. The three-cell string was then sandwiched between the two C-beams, with polymer plugs inserted in the perforations. The assembly was then hot-pressed to melt the thermoplastic, join the two halves of the I-beam, and encapsulate the cells. The three cells were then filled with electrolyte, went through an SEI formation process, degassed and re-sealed.

[0161] The three-cell MES Composite prototype module demonstrated a small-scale proof-of-concept. The MES Composite I-beam is charged up the specified voltage and placed on a support span of 8" separation with a 2-lb weight applied at the midpoint. The I-beam is capable of concurrently supplying electrical power to operate a 12V DC fan, drawing 150 mA constant current or 1.8 W power (~C/3). This preliminary result shows that the MES Composites could be scaled up to a multi-cell structural system and still maintain the rate capability of the baseline single cells while carrying mechanical loads. This test has proved that multi-cell MES Composite modules can safely undergo concurrent mechanical/electrochemical experiments.

[0162] As used herein, the singular terms "a," "an," and "the" include plural referents unless the context clearly dictates otherwise. Thus, for example, reference to a molecule can include multiple molecules unless the context clearly dictates otherwise.

[0163] As used herein, the terms "substantially," "substantial," and "about" are used to describe and account for small variations. When used in conjunction with an event or circumstance, the terms can refer to instances in which the event or circumstance occurs

precisely as well as instances in which the event or circumstance occurs to a close approximation. For example, when used in connection with a numerical value, the terms can refer to a range of variation of less than or equal to $\pm 10\%$ of that numerical value, such as less than or equal to $\pm 5\%$, less than or equal to $\pm 4\%$, less than or equal to $\pm 3\%$, less than or equal to $\pm 2\%$, less than or equal to $\pm 1\%$, less than or equal to $\pm 0.5\%$, less than or equal to $\pm 0.1\%$, or less than or equal to $\pm 0.05\%$.

[0164] Additionally, amounts, ratios, and other numerical values are sometimes presented herein in a range format. It is to be understood that such range format is used for convenience and brevity and should be understood flexibly to include numerical values explicitly specified as limits of a range, but also to include all individual numerical values or sub-ranges encompassed within that range as if each numerical value and sub-range is explicitly specified. For example, a ratio in the range of about 1 to about 200 should be understood to include the explicitly recited limits of about 1 and about 200, but also to include individual ratios such as about 2, about 3, and about 4, and sub-ranges such as about 10 to about 50, about 20 to about 100, and so forth.

[0165] In the foregoing description, it will be readily apparent to one skilled in the art that varying substitutions and modifications may be made to the invention disclosed herein without departing from the scope and spirit of the invention. The invention illustratively described herein suitably may be practiced in the absence of any element or elements, limitation or limitations, which is not specifically disclosed herein. The terms and expressions which have been employed are used as terms of description and not of limitation, and there is no intention that in the use of such terms and expressions of excluding any equivalents of the features shown and described or portions thereof, but it is recognized that various modifications are possible within the scope of the invention. Thus, it should be understood that although the present invention has been illustrated by specific embodiments and optional features, modification and/or variation of the concepts herein disclosed may be resorted to by those skilled in the art, and that such modifications and variations are considered to be within the scopes of this invention.

EMBODIMENTS IN WHICH AN EXCLUSIVE PROPERTY OR PRIVILEGE IS CLAIMED ARE DEFINED AS FOLLOWS:

1. A multifunctional energy storage (MES) composite comprising (a) a stack of energy storage materials, (b) two structural facesheets sandwiching the stack of energy storage materials, (c) one or more reinforcements perforating the stack of energy storage materials, and (d) a reinforcement frame disposed along a lateral perimeter of the stack of energy storage materials and between the structural facesheets, wherein the reinforcements are bonded to the structural facesheets,

wherein one or more of the reinforcements enhance battery rigidity and further comprise a thermal device selected from a group comprising a heat sink, a heat source, a heat pipe, and heat transfer rods arranged such that each heat transfer rod extends a length along an alignment axis passing through the perforations in the stack of energy storage materials, and wherein the heat transfer rods are positioned in thermal communication with one of a heat sink and a heat source.

2. The MES composite of claim 1, wherein the structural facesheets comprise at least one material from a group comprising fiber-reinforced polymers, thermosets, thermoplastics, metals, metal alloys, ceramics, and polymers.

3. The MES composite of claim 1, wherein the structural facesheets comprise at least one fiber-reinforced polymer, wherein the fiber-reinforced polymer comprises fibers selected from a group consisting of carbon fibers, glass fibers, and aramid fibers, and wherein the fiber-reinforced polymer comprises one of a thermoset and a thermoplastic.

4. The MES composite of claim 1, wherein the structural facesheets comprise at least one polymer from a group comprising polyolefin, poly(ethylene-co-methacrylic acid), poly(ethylene), poly(ethylene-co-vinyl acetate), poly(ethylene-co-acrylic acid), polytetrafluoroethylene, polyoxymethylene, poly-oxydiphenylene-pyromellitimide, perfluoroalkoxy, fluorinated ethylene propylene, polypropylene, polyethylene, polyvinylidene fluoride, polyetherimide, polyether ether ketone, polyethylene terephthalate, polyester, polyamide, silicone, and combinations thereof.

5. The MES composite of claim 1, wherein at least one of the structural facesheets is coated with a coating layer of at least one polymer from a group comprising polyolefin, poly(ethylene-co-methacrylic acid), poly(ethylene), poly(ethylene-co-vinyl acetate), poly(ethylene-co-acrylic acid), polytetrafluoroethylene, polyoxymethylene, polyoxydiphenylene-pyromellitimide, perfluoroalkoxy, fluorinated ethylene propylene, polypropylene, polyethylene, polyvinylidene fluoride, polyetherimide, polyether ether ketone, polyethylene terephthalate, polyester, polyamide, silicone, and combinations thereof.
6. The MES composite of claim 5, wherein the coating layer comprises a composite of the polymer and at least one additive, wherein the additive is from a group comprising plastics, ceramics, firebrick, refractory material, carbon, silicon, silica, silicon carbide, metals, metal oxides, and metal alloys.
7. The MES composite of claim 1, wherein the reinforcements comprise at least one polymer from a group comprising polyolefin, poly(ethylene-co-methacrylic acid), poly(ethylene), poly(ethylene-co-vinyl acetate), poly(ethylene-co-acrylic acid), polytetrafluoroethylene, polyoxymethylene, polyoxydiphenylene-pyromellitimide, perfluoroalkoxy, fluorinated ethylene propylene, polypropylene, polyethylene, polyvinylidene fluoride, polyetherimide, polyether ether ketone, polyethylene terephthalate, polyester, polyamide, silicone, and combinations thereof.
8. The MES composite of claim 7, wherein the reinforcements comprise a composite of the polymer and at least one additive, wherein the additive is from a group comprising plastics, ceramics, firebrick, refractory material, carbon, silicon, silica, silicon carbide, metals, metal oxides, and metal alloys.
9. The MES composite of claim 1, wherein the reinforcements comprise at least one material from a group comprising fiber-reinforced polymers, thermosets, thermoplastics, metals, metal alloys, ceramics, and polymers.
10. The MES composite of claim 1, wherein the reinforcements comprise at least one fiber-reinforced polymer, wherein the fiber-reinforced polymer comprises fibers from a group comprising carbon fibers, glass fibers, and aramid fibers, and wherein the fiber-reinforced polymer comprises one of a thermoset and a thermoplastic.

11. The MES composite of claim 1, wherein one or more of the reinforcements further comprise one of a dielectric and an inert coating on a surface.
12. The MES composite of claim 1, wherein one or more of the reinforcements further comprise a group of internal reinforcement rivets, wherein the group of internal reinforcement rivets are arranged such that the internal reinforcement rivets extend a length along an alignment axis passing through the perforations in the stack of energy storage materials.
13. The MES composite of claim 1, wherein one or more of the reinforcements further comprise of a porous rod, or wherein one or more of the reinforcements comprise a hollow rod with porous walls, or wherein the reinforcements are a plurality of tubes arranged along an alignment axis passing through perforations in the stack of energy storage materials.
14. The MES composite of claim 13, wherein pores of one or more porous reinforcements or interior of one or more hollow reinforcements or one or more tubes are filled with one of a fluid, a liquid electrolyte, a fuel fluid, an aqueous solution, a gas, and a thermal-management substance.
15. The MES composite of claim 14, wherein the fluid, liquid electrolyte, aqueous solution, and gas flows through one of the pores of one or more porous reinforcements, the interior of one or more hollow reinforcements, and the tubes along an alignment axis passing through the perforations in the stack of energy storage materials.
16. The MES composite of claim 1, wherein one or more of the reinforcements further comprise one of an actuator, a transducer materials, and a device from a group comprising electromagnetic devices, electrochemical devices, electromechanical devices, electroacoustic devices, electrostatic devices, thermoelectric devices, and radio acoustic devices.
17. A multifunctional energy storage (MES) composite comprising (a) a stack of energy storage materials, (b) two structural facesheets sandwiching the stack of energy storage materials, (c) one or more reinforcements perforating the stack of energy storage materials, and (d) a reinforcement frame disposed along an entire lateral perimeter of the stack of energy storage materials and between the structural facesheets, wherein the reinforcements are bonded to the structural facesheets, wherein one or more of the reinforcements enhance

battery rigidity and further comprise cables of conduits for electrical signal transmission and electrical conduction.

18. A multifunctional energy storage (MES) comprising (a) a stack of energy storage materials, (b) two structural facesheets sandwiching the stack of energy storage materials, (c) one or more reinforcements perforating the stack of energy storage materials, and (d) a reinforcement frame disposed along an entire lateral perimeter of the stack of energy storage materials and between the structural facesheets, wherein the reinforcements are bonded to the structural facesheets, wherein one or more of the reinforcements enhance battery rigidity and further comprise at least one sensor selected from a group comprising strain gauges, thermocouples, thermistors, pressure sensors, tactile sensors, piezoelectric sensors, voltage sensors, current sensors, and humidity sensors.

19. The MES composite of claim 1, where the stack of energy storage materials forms part of a device from a group comprising a primary electrochemical cell, a secondary electrochemical cell, a lead-acid cell, a lithium cell, a lithium-ion cell, a zinc-carbon cell, an alkaline cell, a nickel cadmium cell, a nickel metal hydride cell, a silver oxide cell, a sodium sulfur cell, a solid electrochemical cell, a fluid electrochemical cell, , a capacitor, a supercapacitor, a flow battery, a metal-air battery, and a semi-solid battery.

20. The MES composite of claim 1, wherein the structural facesheets comprise a polymer coating, and the reinforcement frame and the polymer coating comprise at least one common polymer, and wherein the reinforcement frame is fused to the polymer coating.

21. The MES composite of claim 1, wherein the structural facesheets comprise a polymer coating, and the reinforcement frame and the polymer coating are bonded by an adhesive layer or by direct chemical bonding.

22. A MES composite comprising (a) a stack of energy storage materials, (b) one or more structural facesheets sandwiching the stack of energy storage materials, and (c) one or more reinforcements perforated by the stack of energy storage materials, wherein the reinforcements are bonded to the structural facesheets.

23. A MES composite comprising (a) a stack of energy storage materials, (b) one or more structural facesheets sandwiching the stack of energy storage materials, (c) a reinforcement case perforated by the stack of energy storage materials, and (d) one or more secondary

reinforcements perforating the stack of energy storage materials, wherein the reinforcement case and the second reinforcements are bonded to the structural facesheets.

24. An energy storage device comprising the MES composite of any one of claims 1-23.

Multifunctional Energy-Storage Composites (MES Composites)

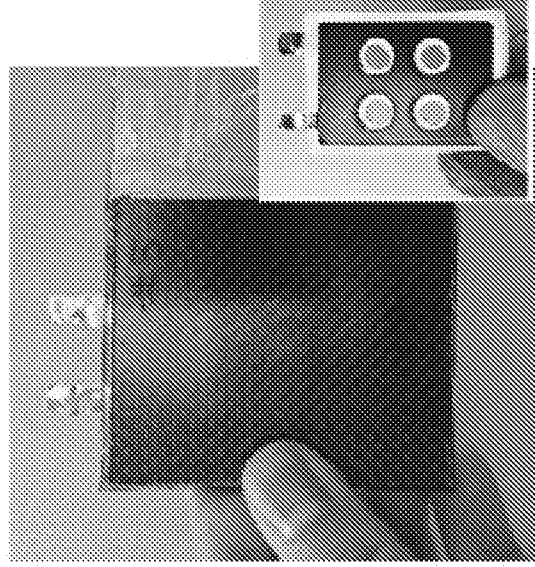
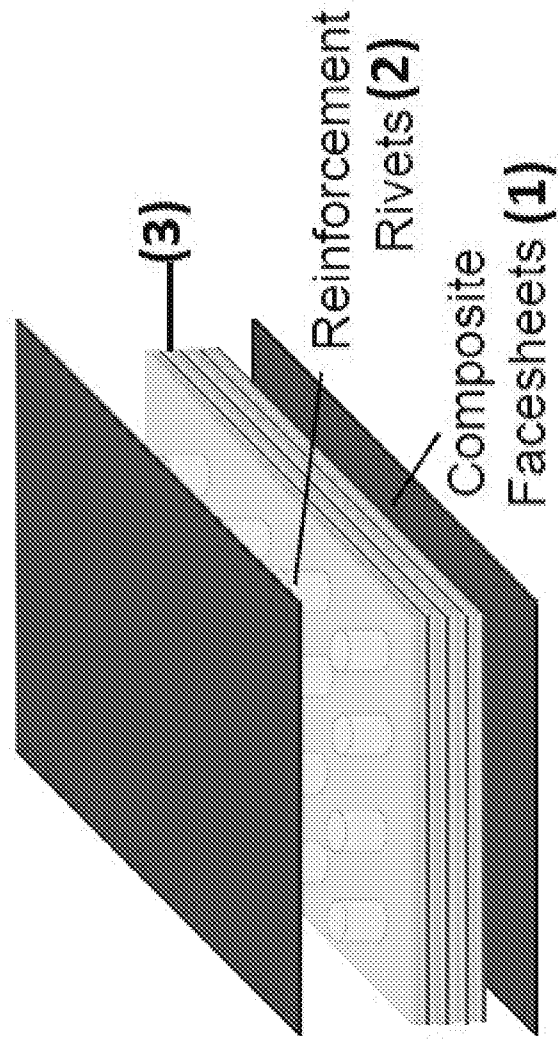

MES Composite Sample

FIGURE 1

In-plane Stiffness and Load Transfer

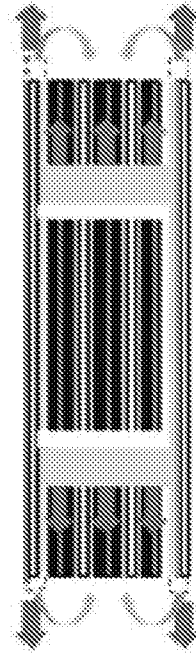
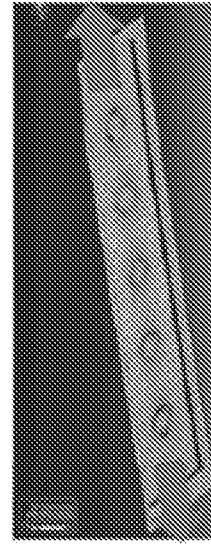
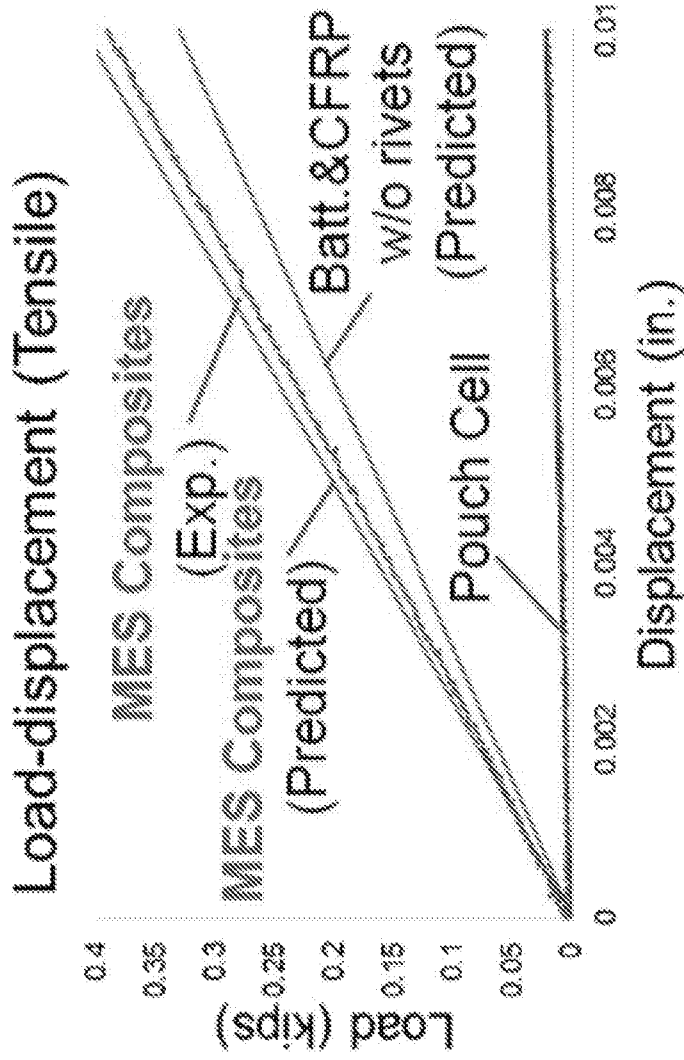
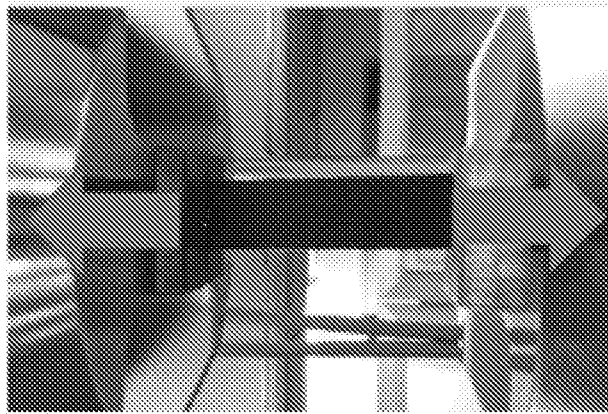

FIGURE 2

Bending Rigidity

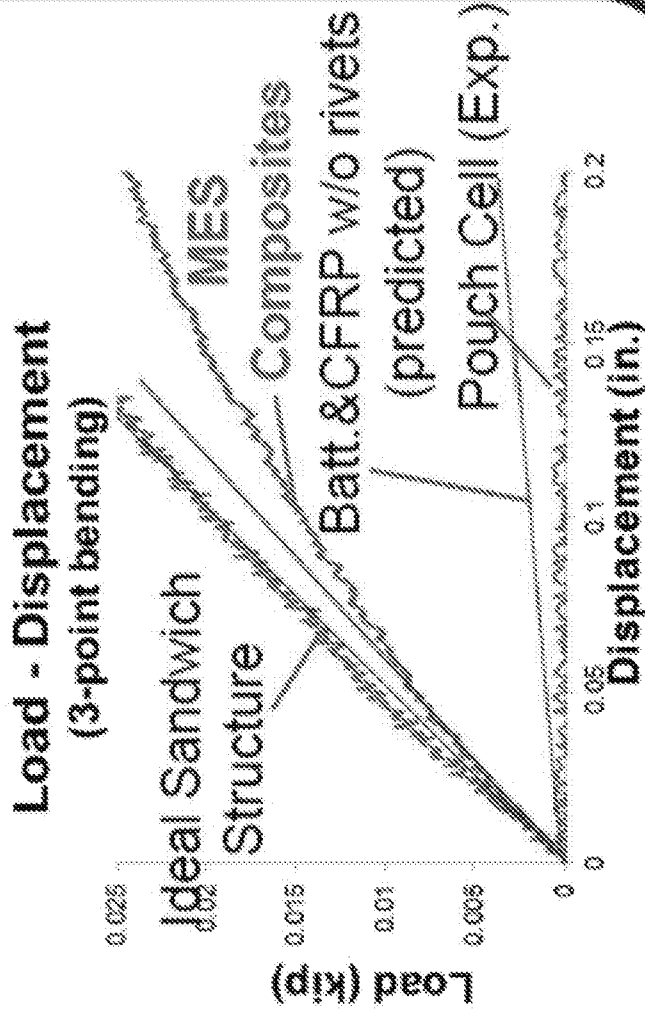
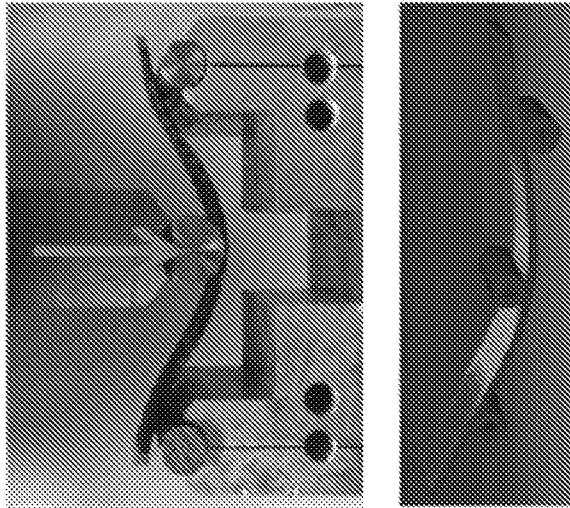

FIGURE 3

Buckling Resistance

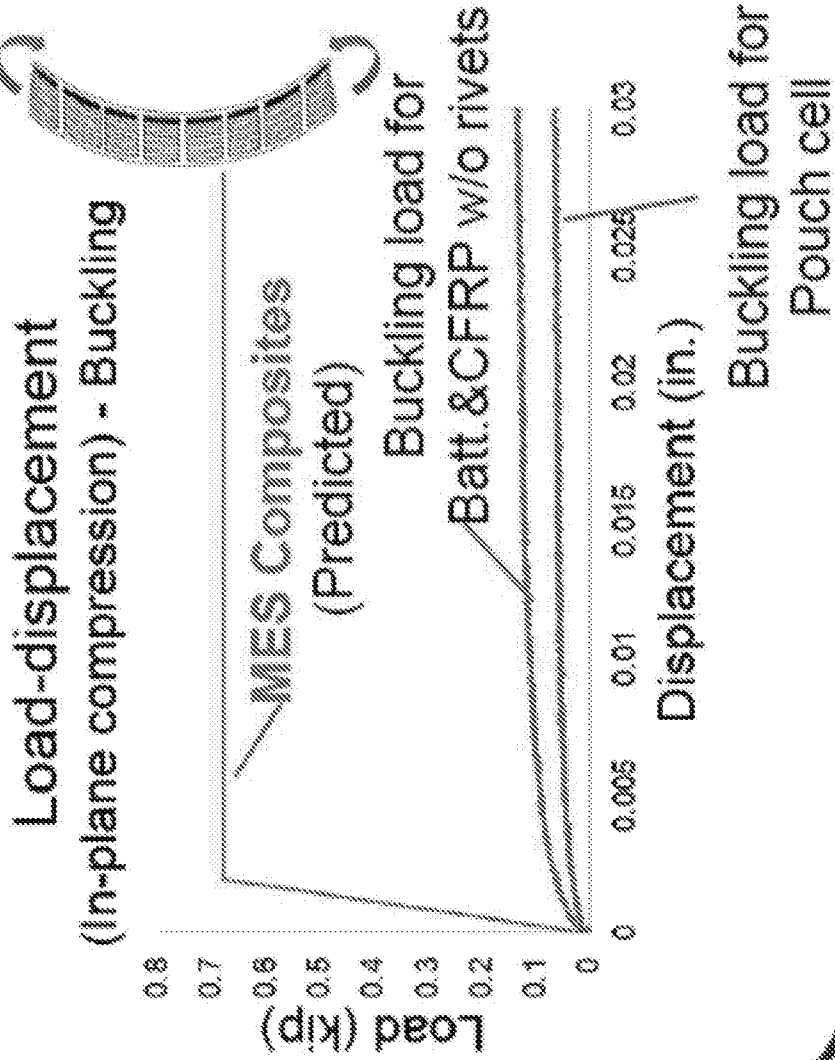

FIGURE 4

Electrochemical Performance

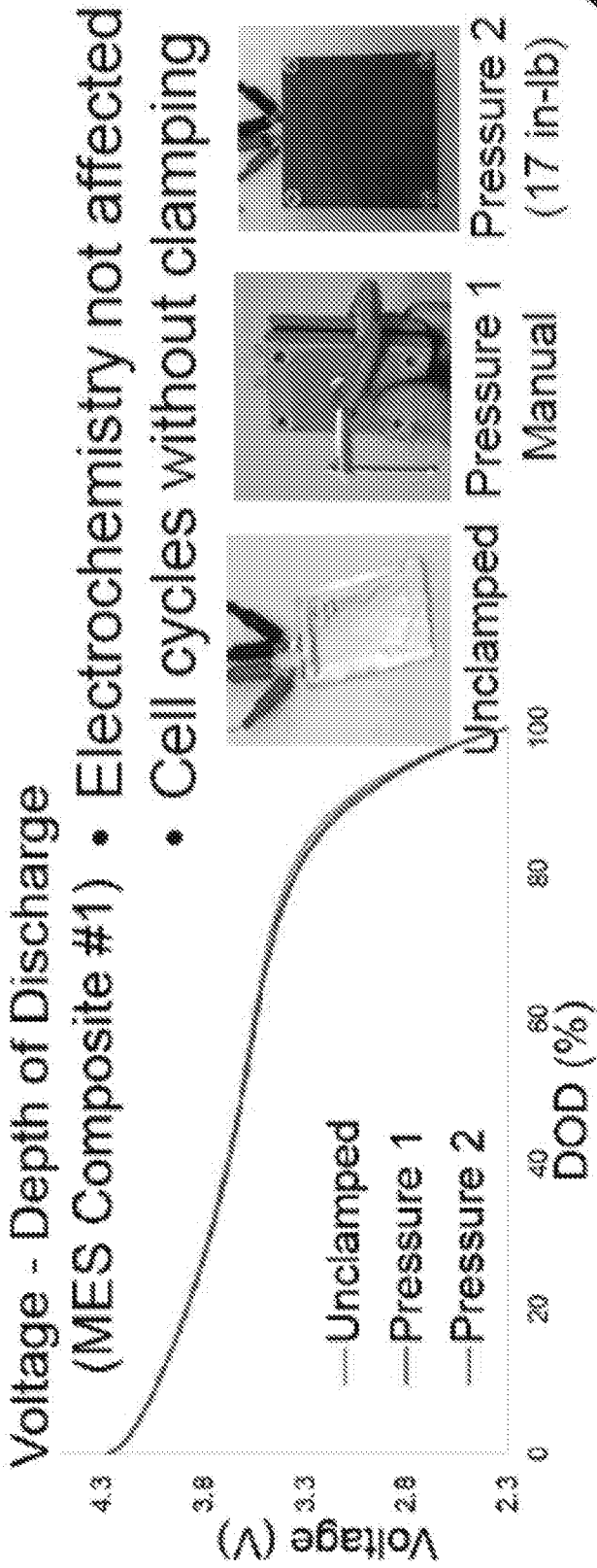

FIGURE 5

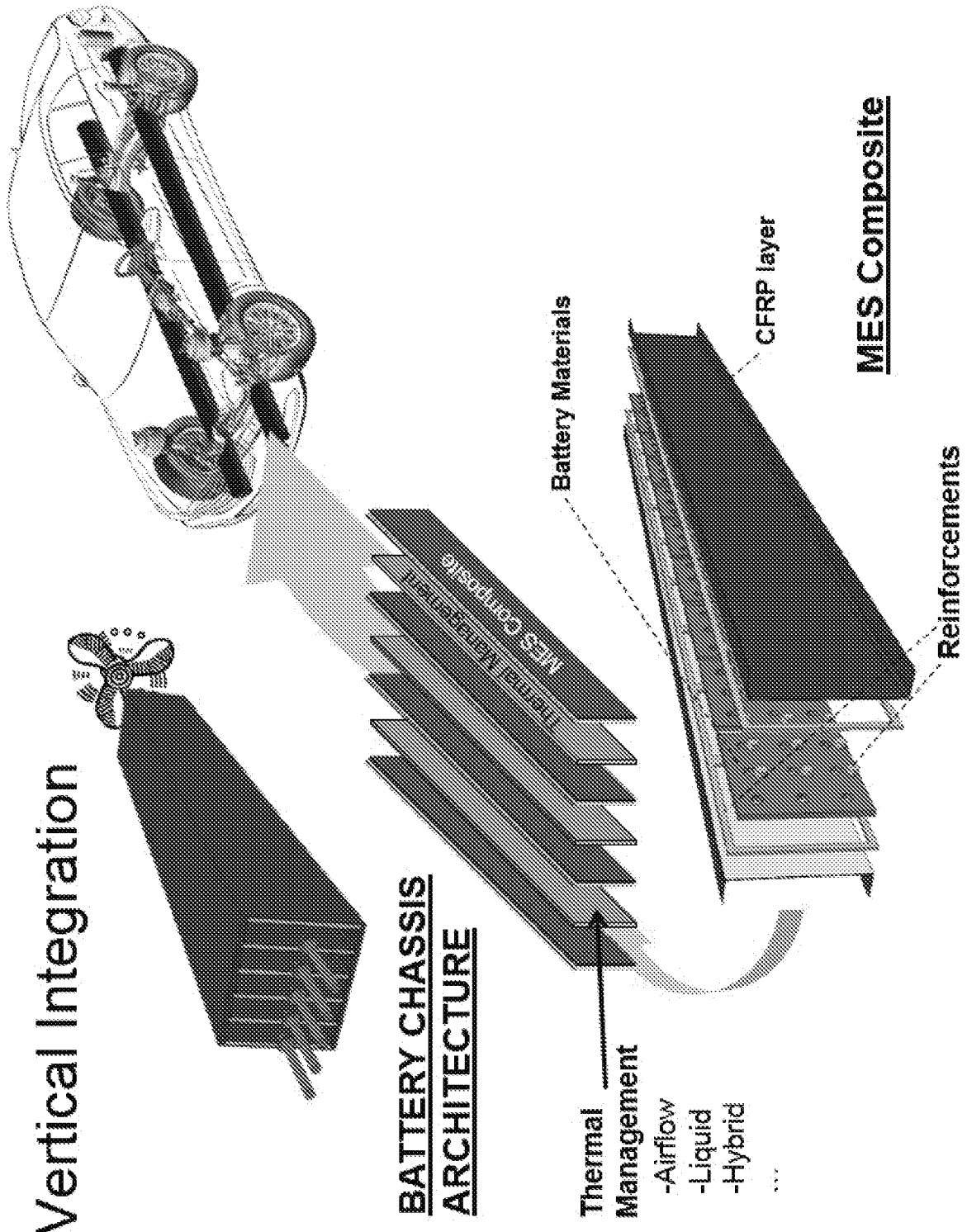

FIGURE 6

Multiple MES composite cells for structural component modules

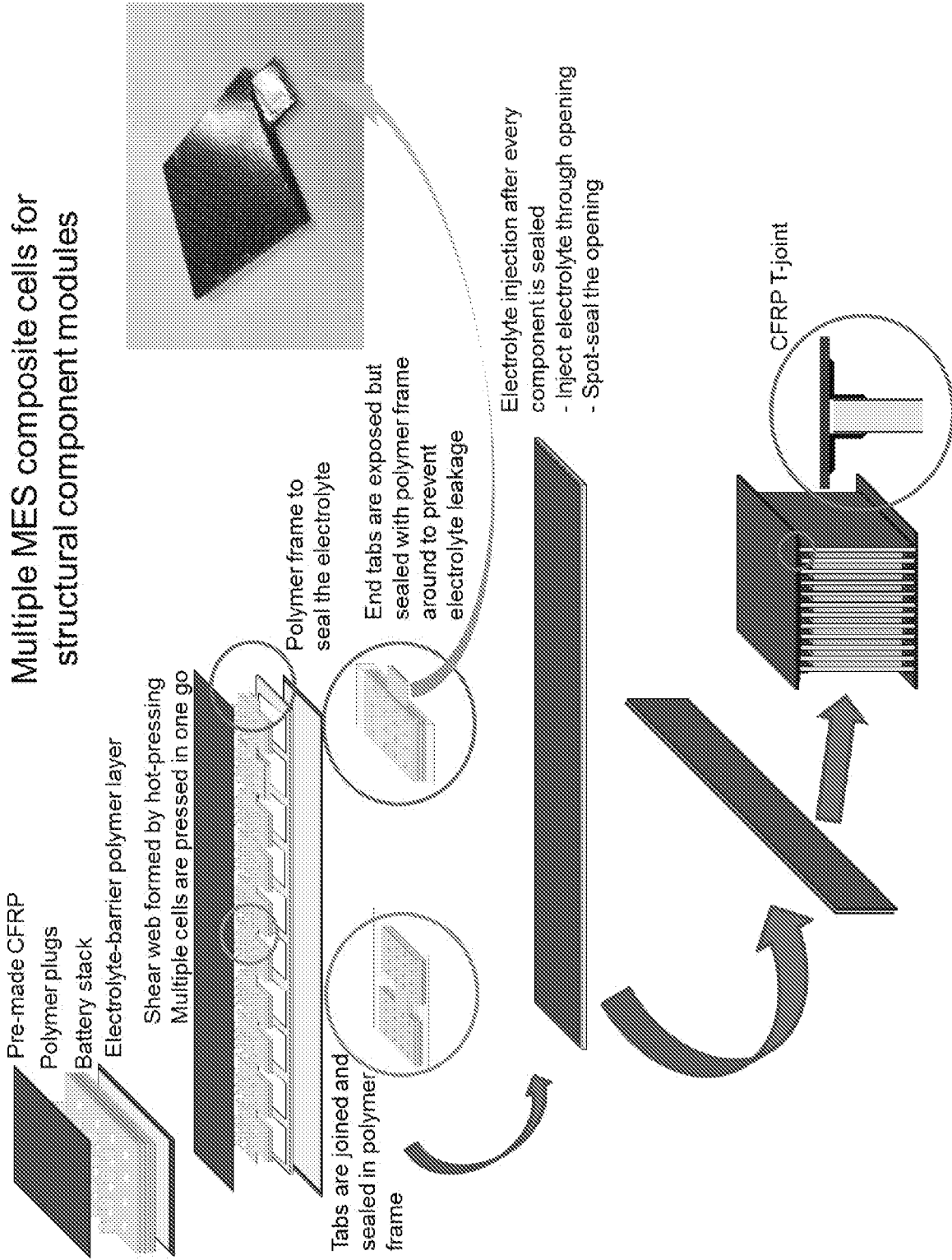

FIGURE 7

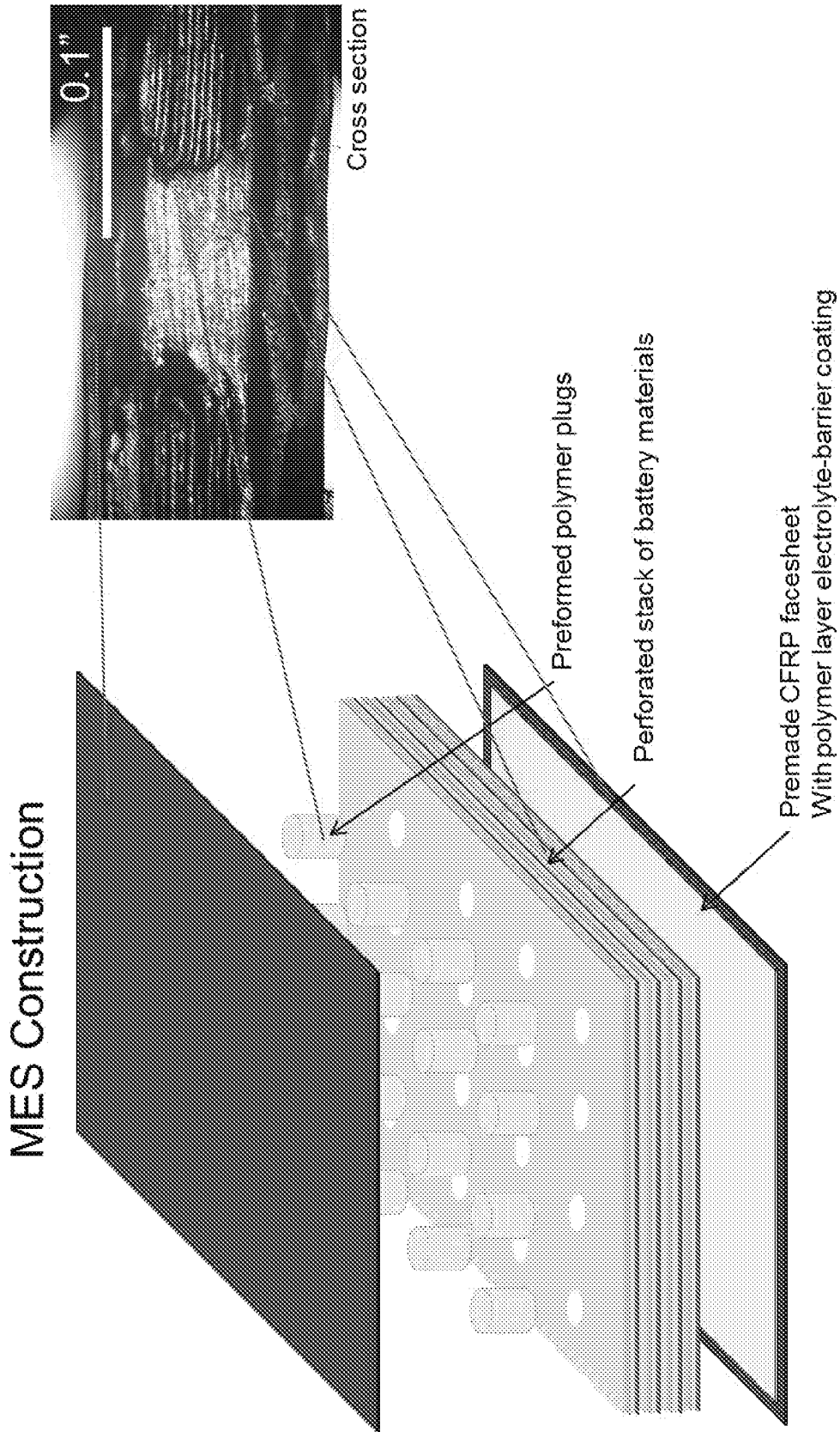

FIGURE 8

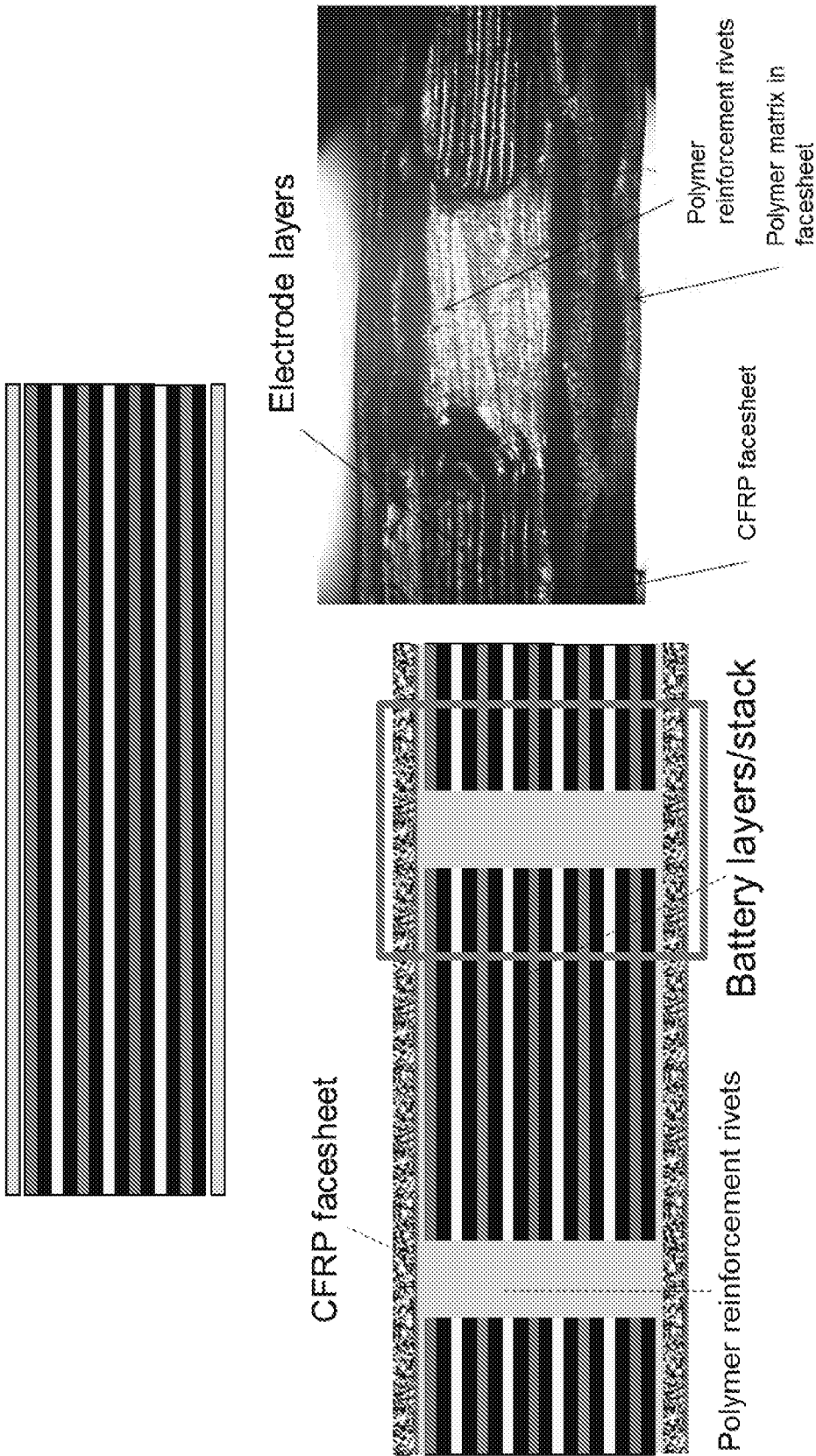
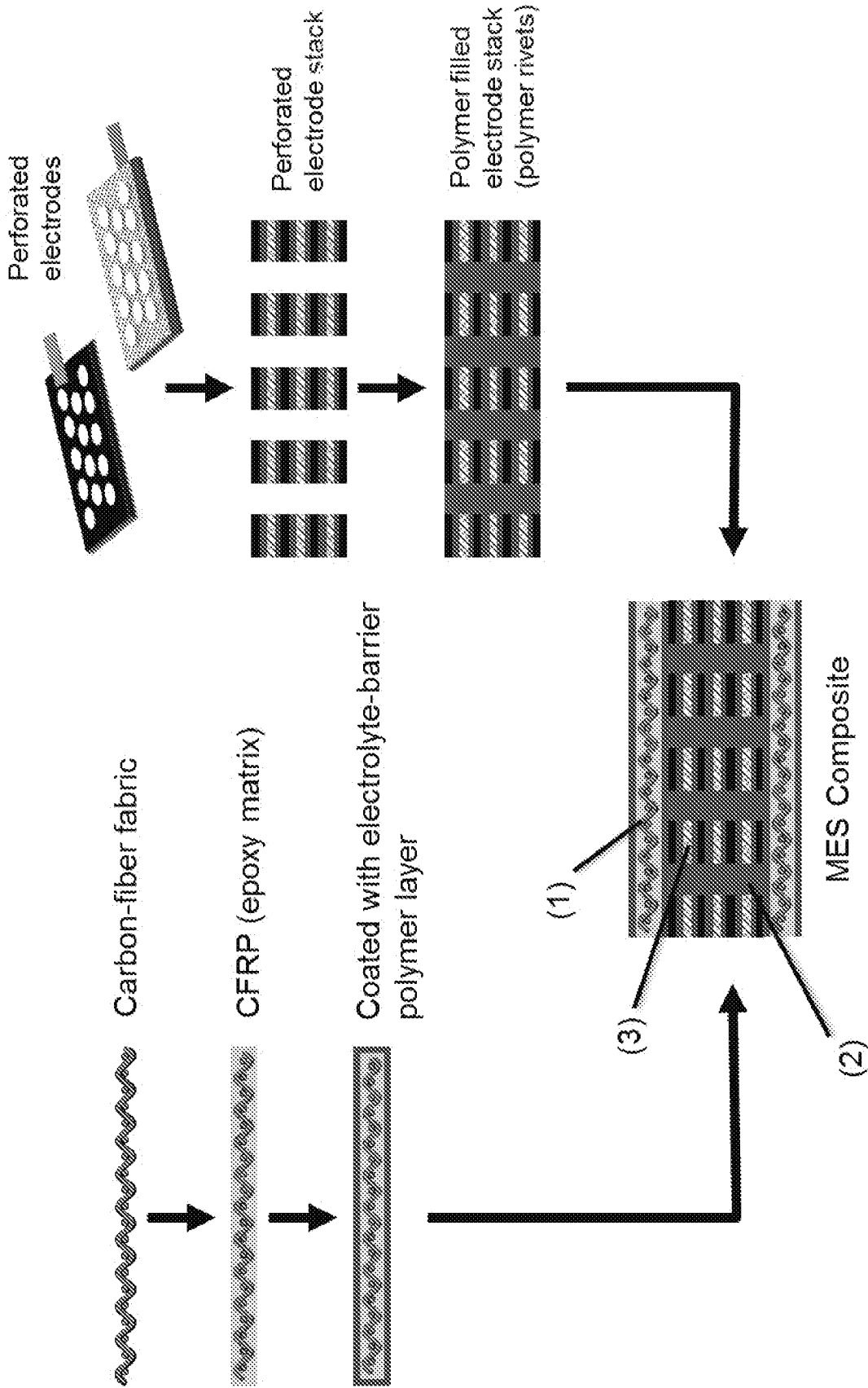

FIGURE 9



MES Composite Assembly Process

FIGURE 10

a. Standard Li-ion Pouch Cell

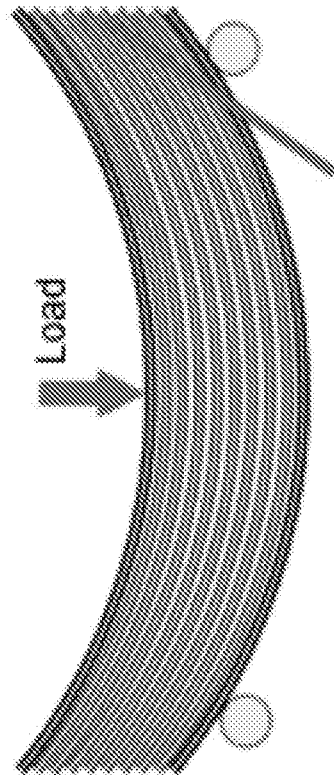
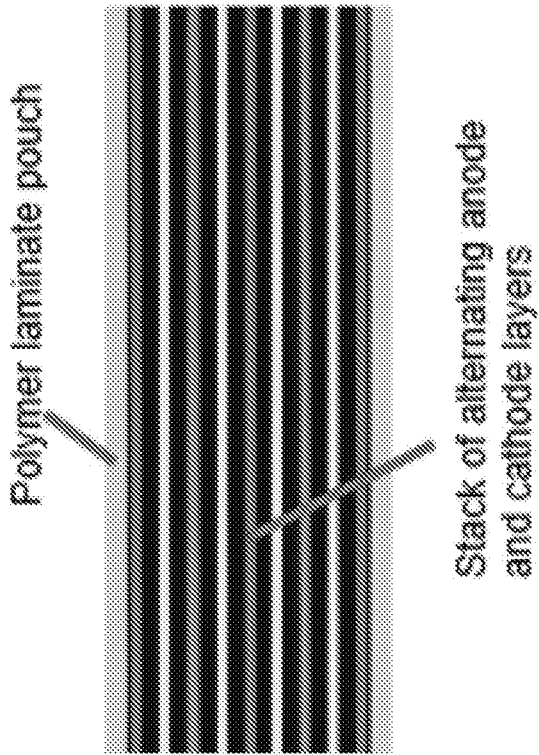

Sliding between layers inhibits load transfer between the two structural facesheets

b. MES Composites

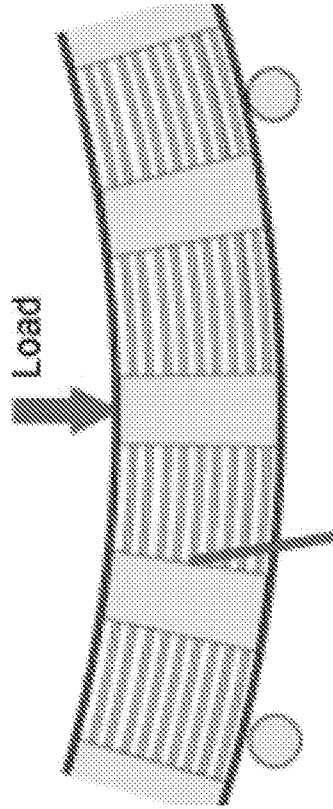
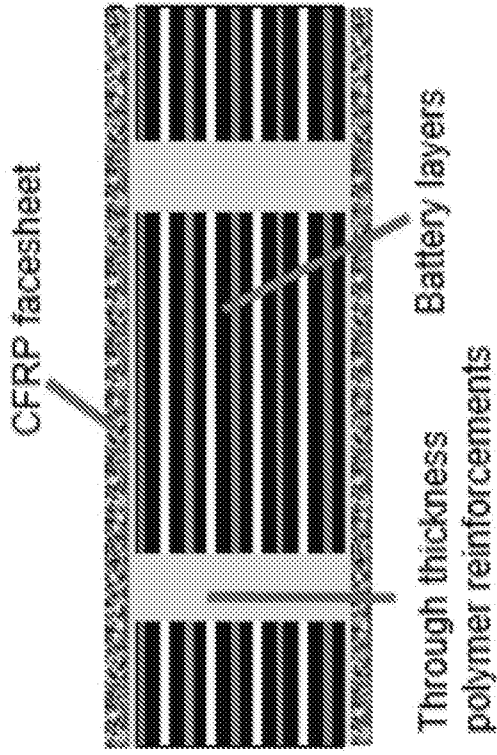

Sliding between layers is minimized, and the laminate bends about a common neutral axis

FIGURE 11

Sample A

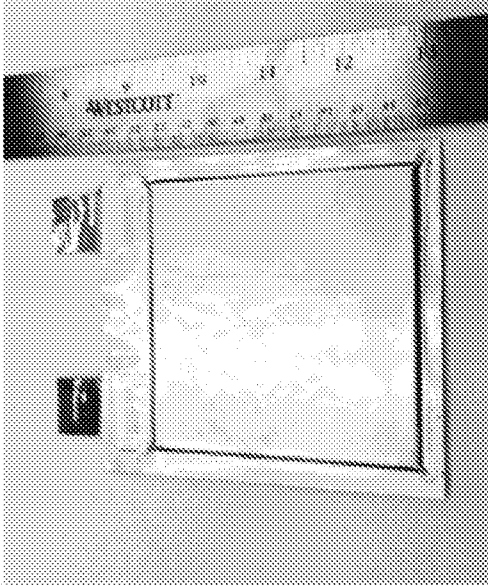

Samples B, C, D (Exterior)

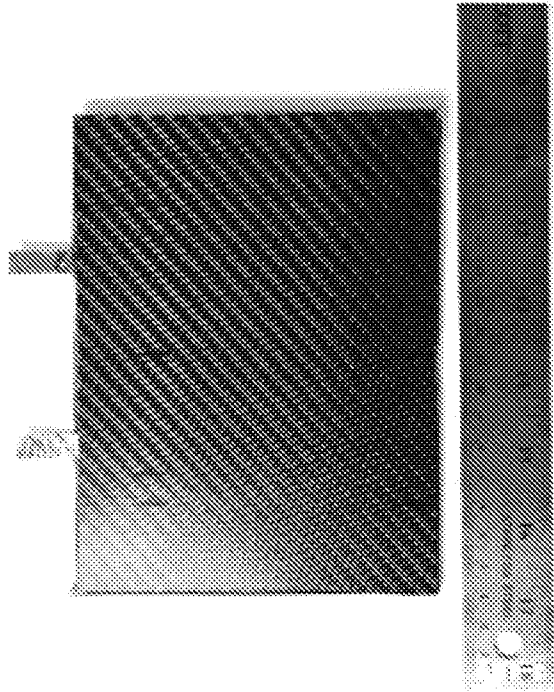

FIGURE 12

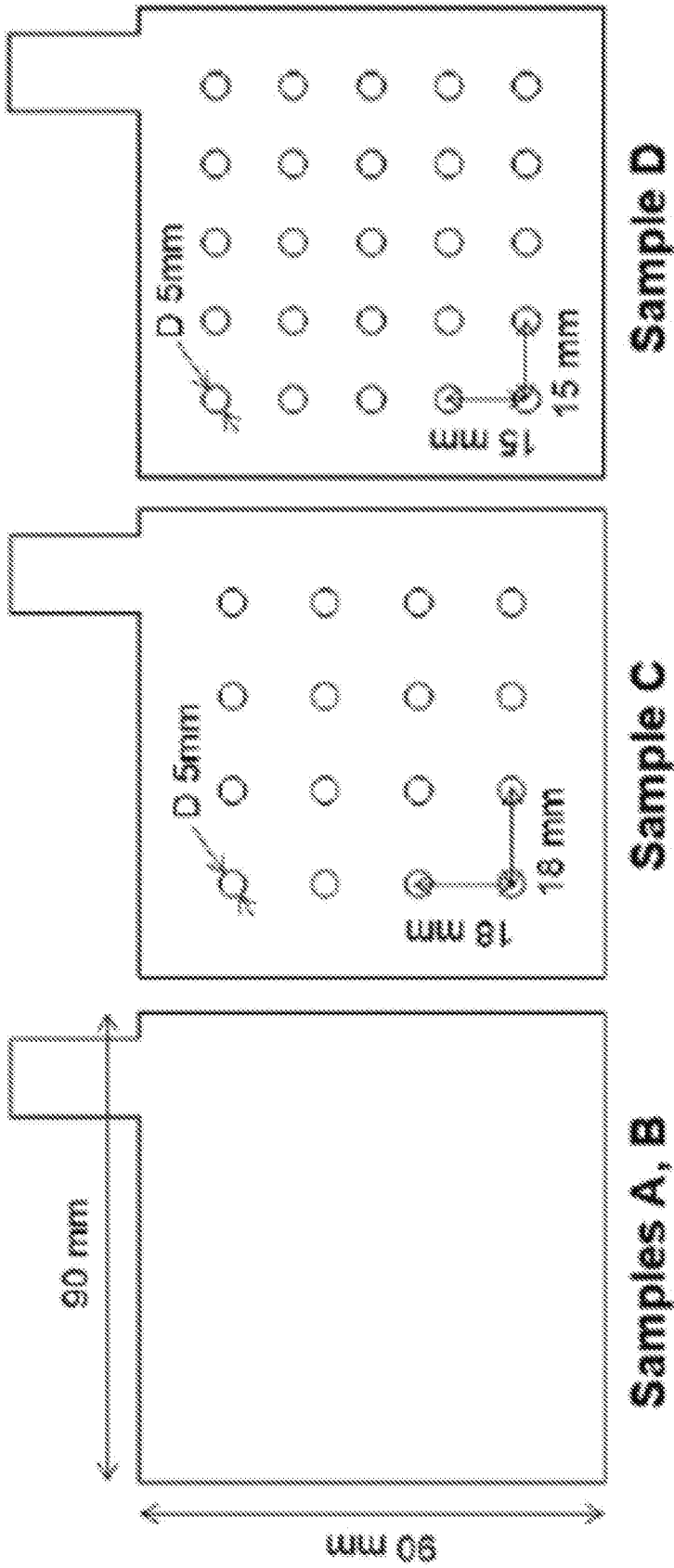
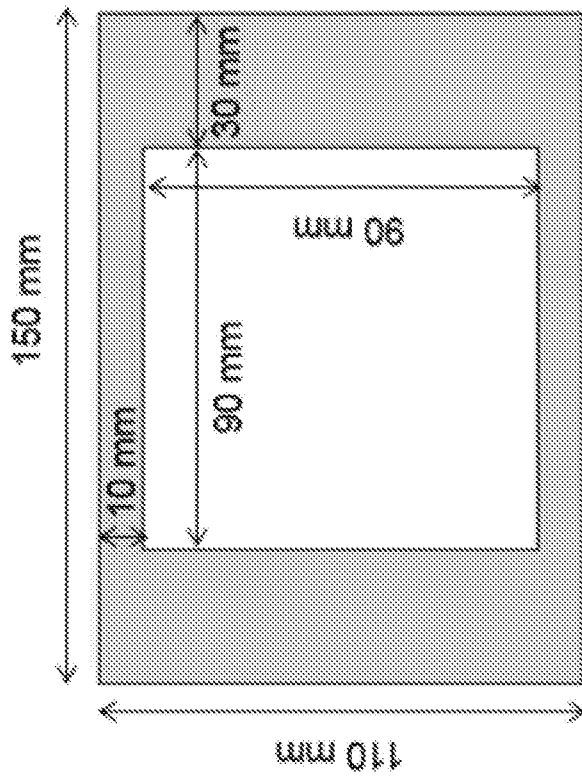
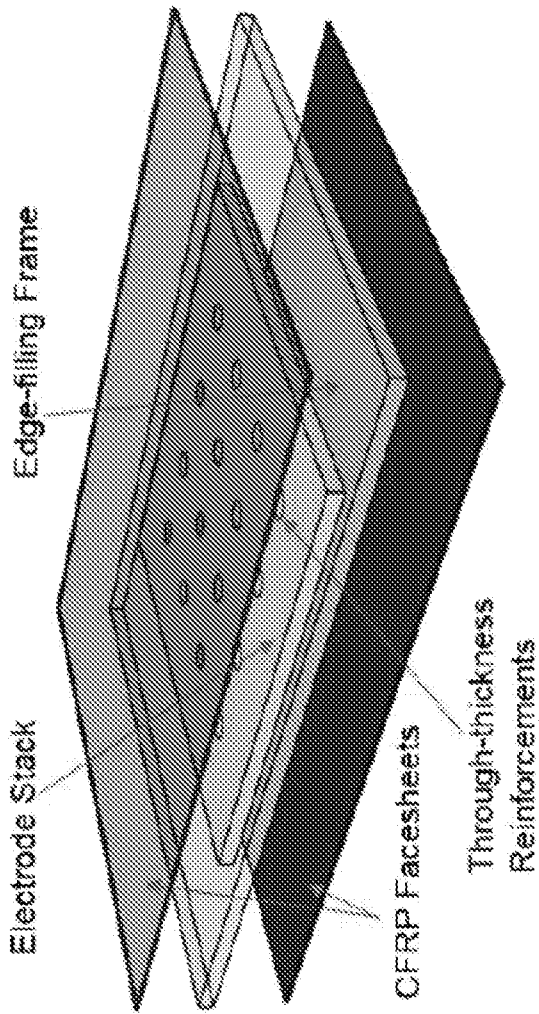

FIGURE 13



Edge-filing frame

FIGURE 14

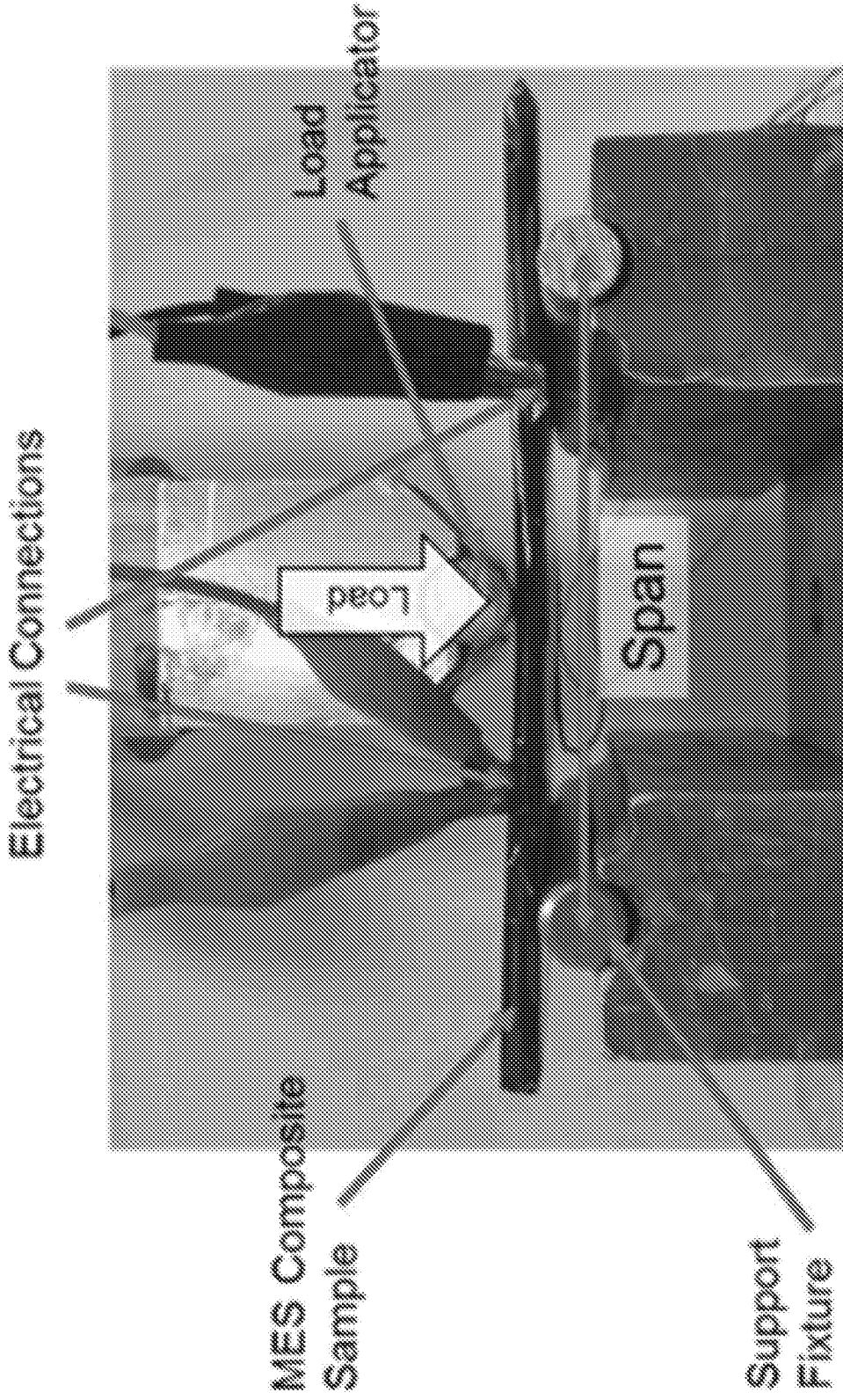

FIGURE 15

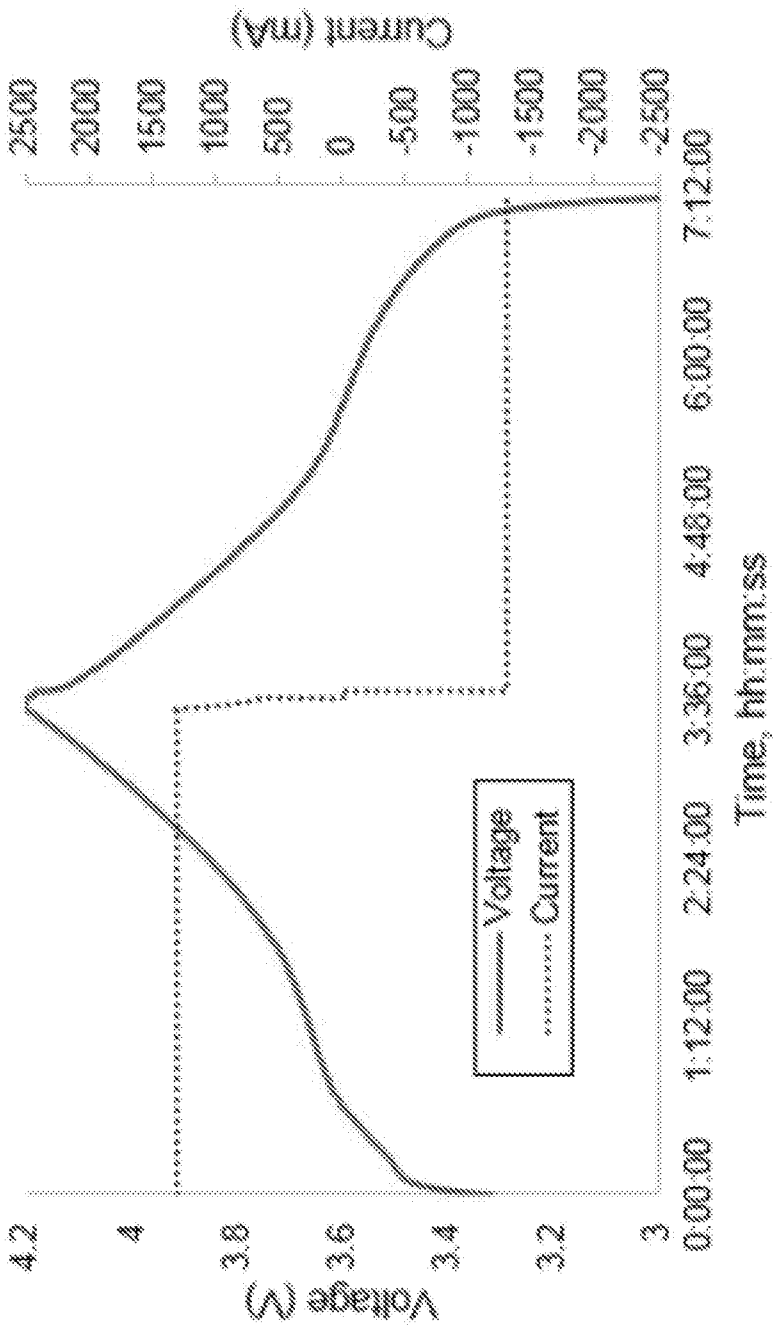

FIGURE 16

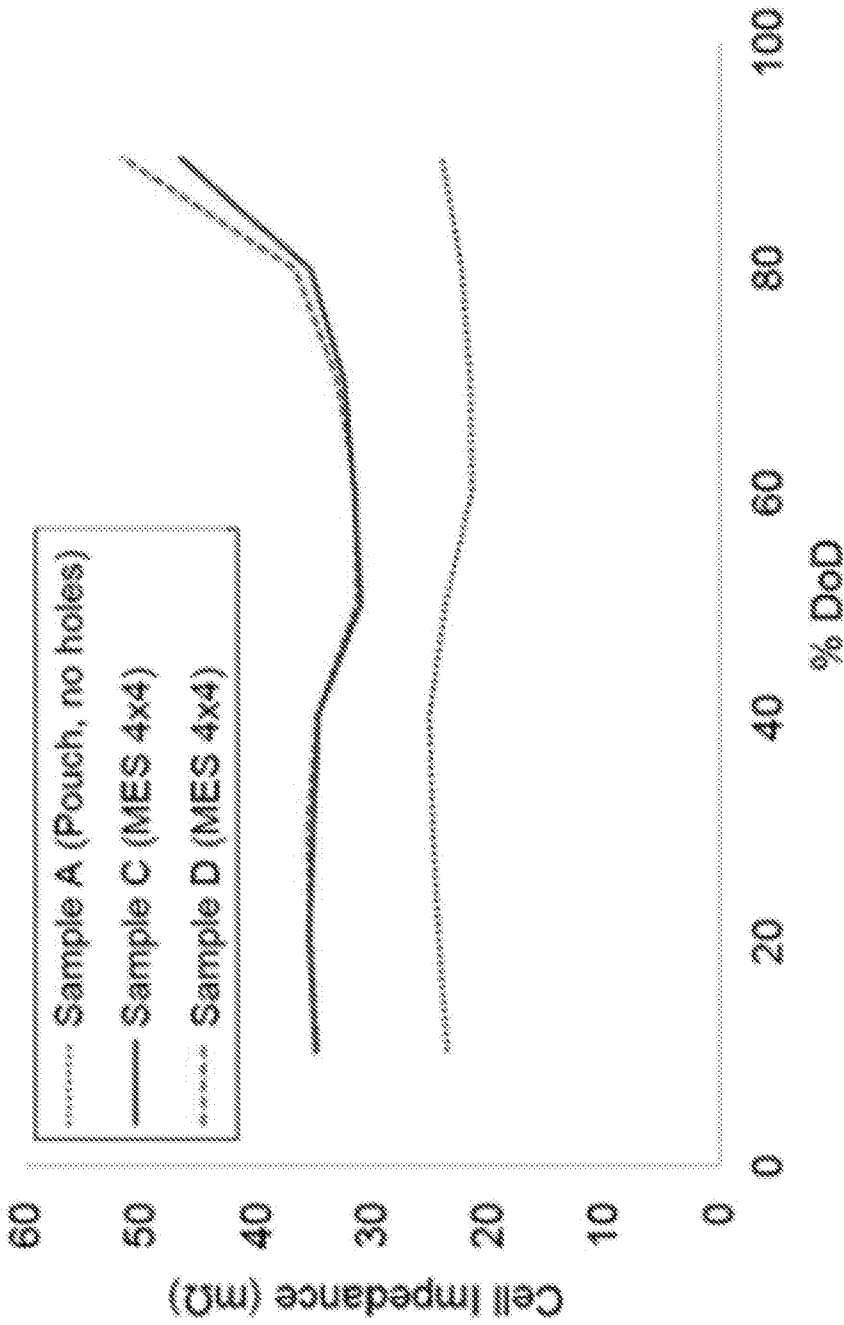

FIGURE 17

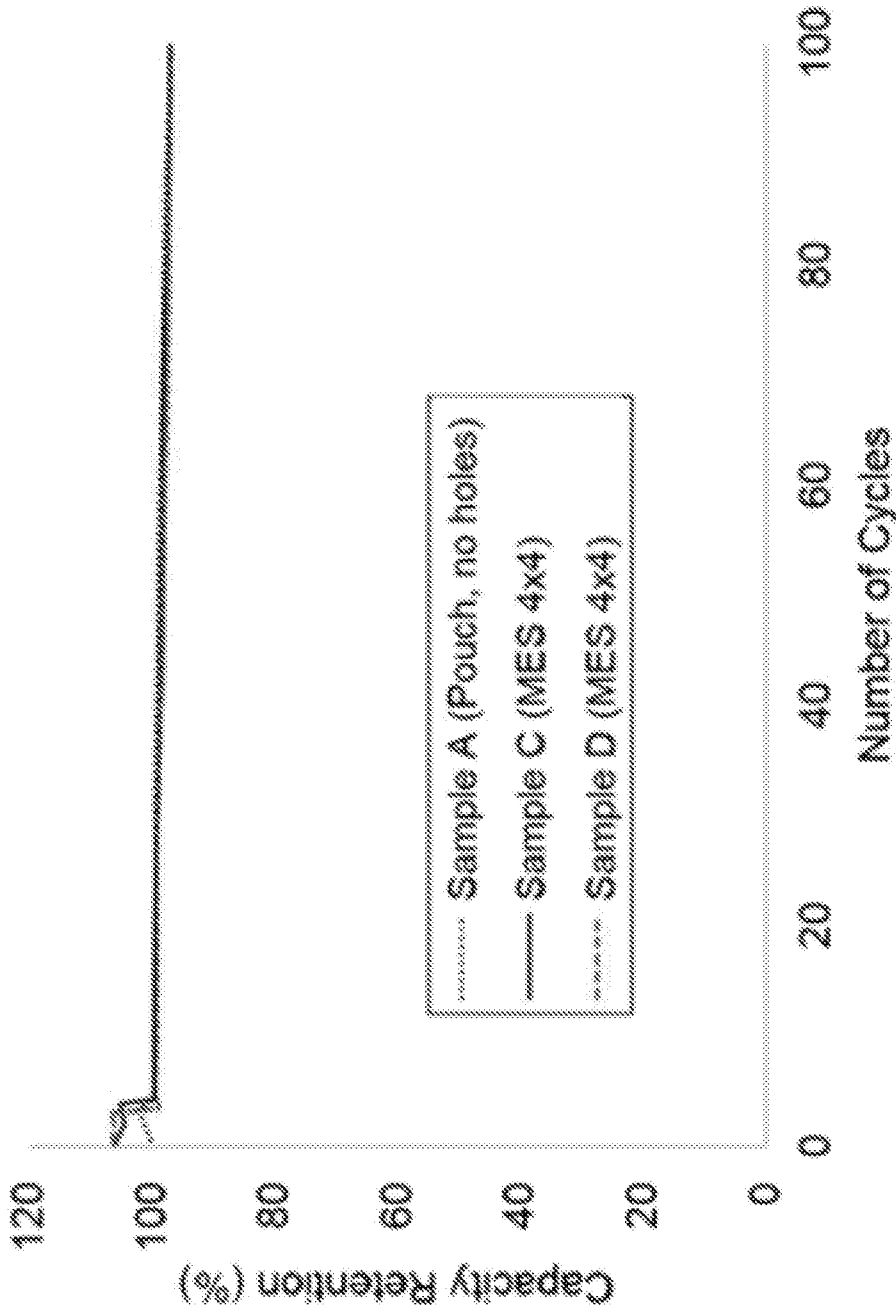

FIGURE 18

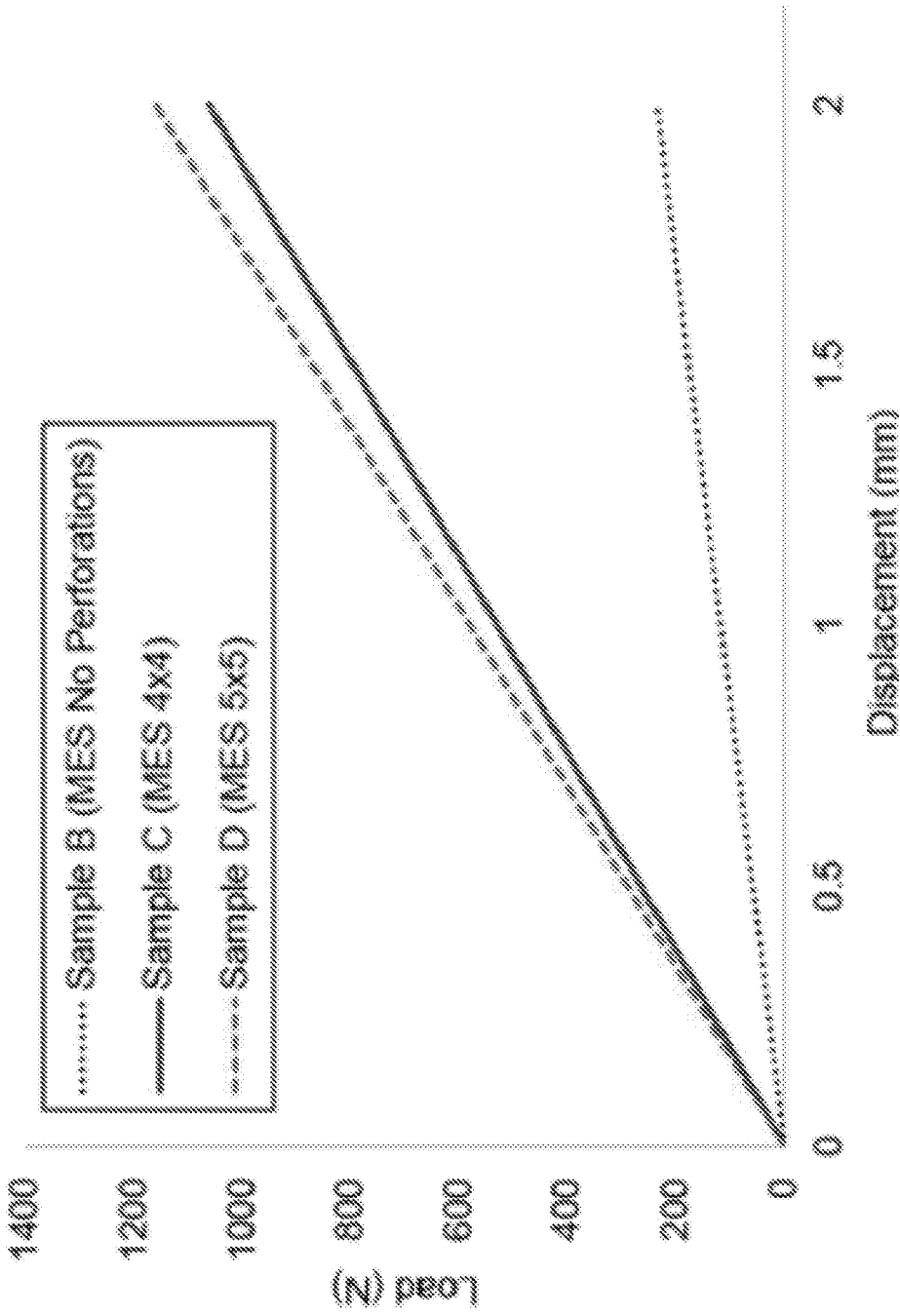

FIGURE 19

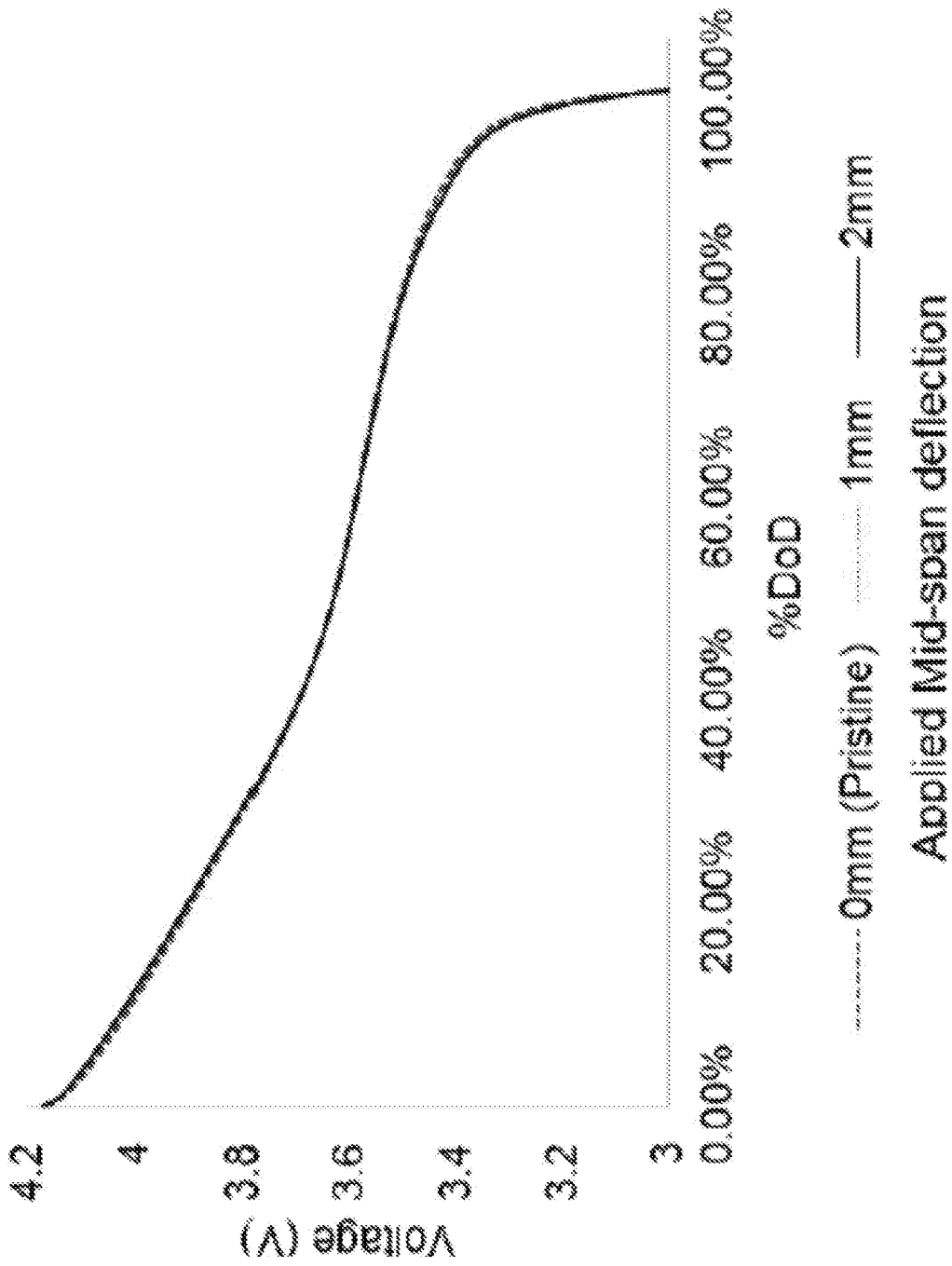

FIGURE 20

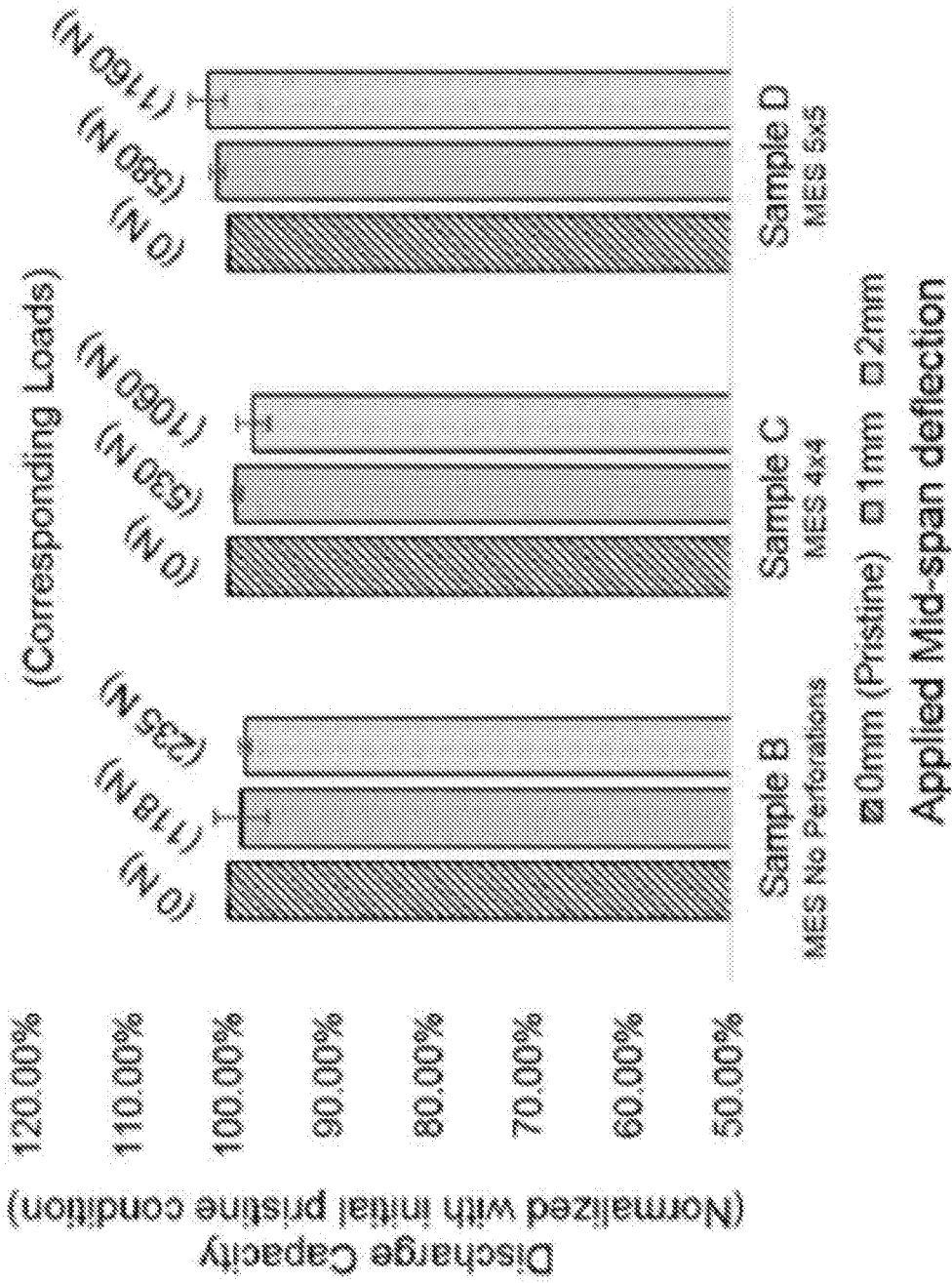

FIGURE 21

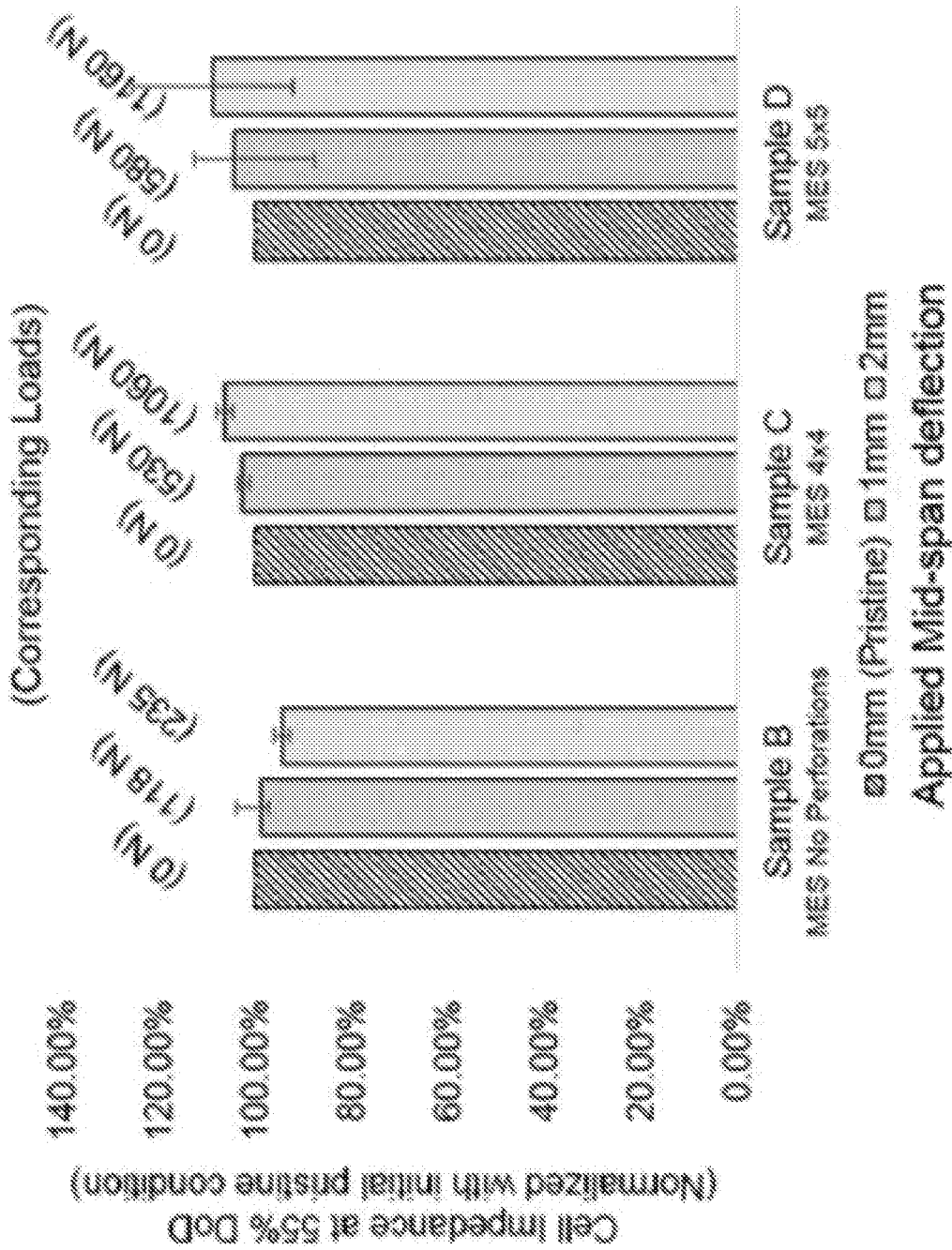

FIGURE 22

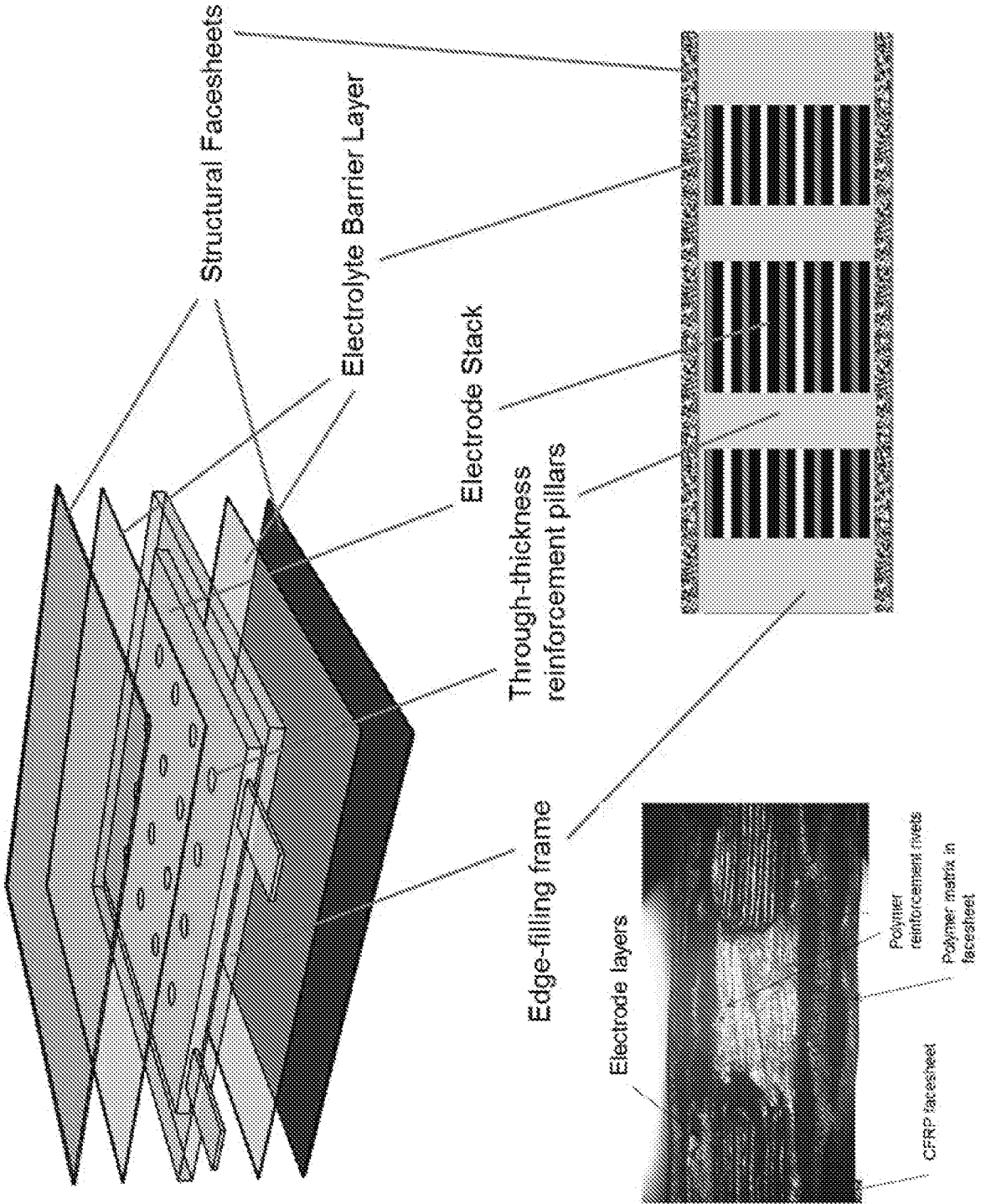

FIGURE 23

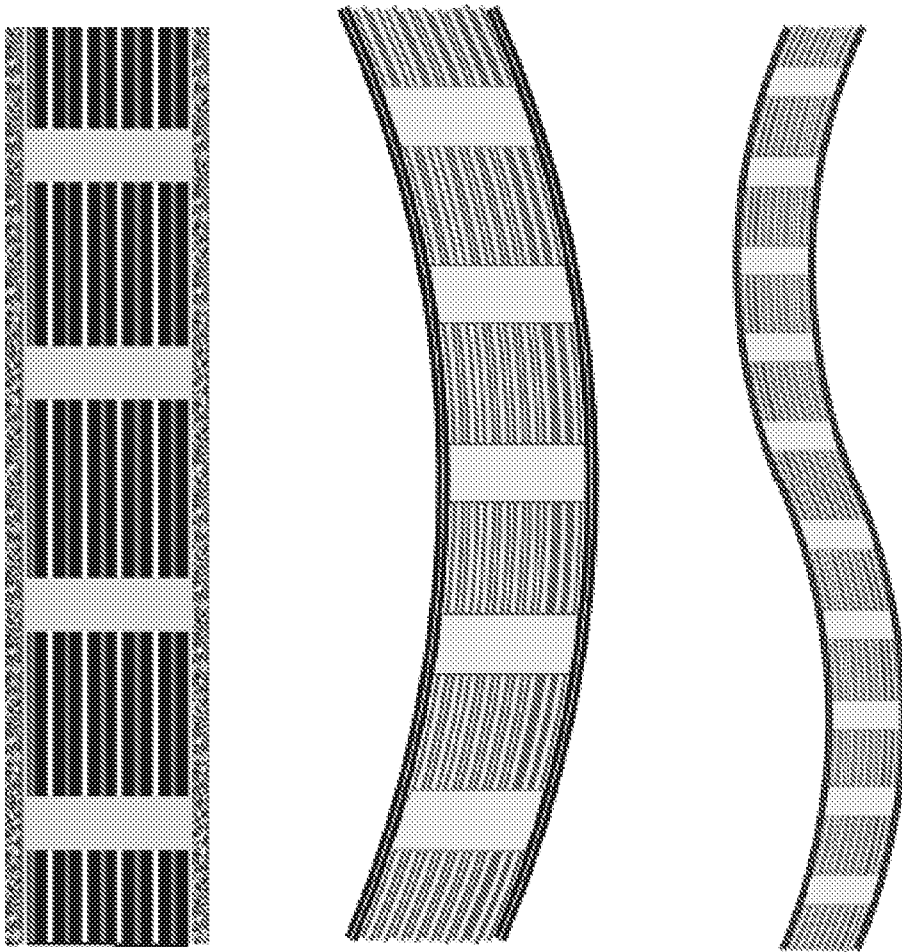

FIGURE 24

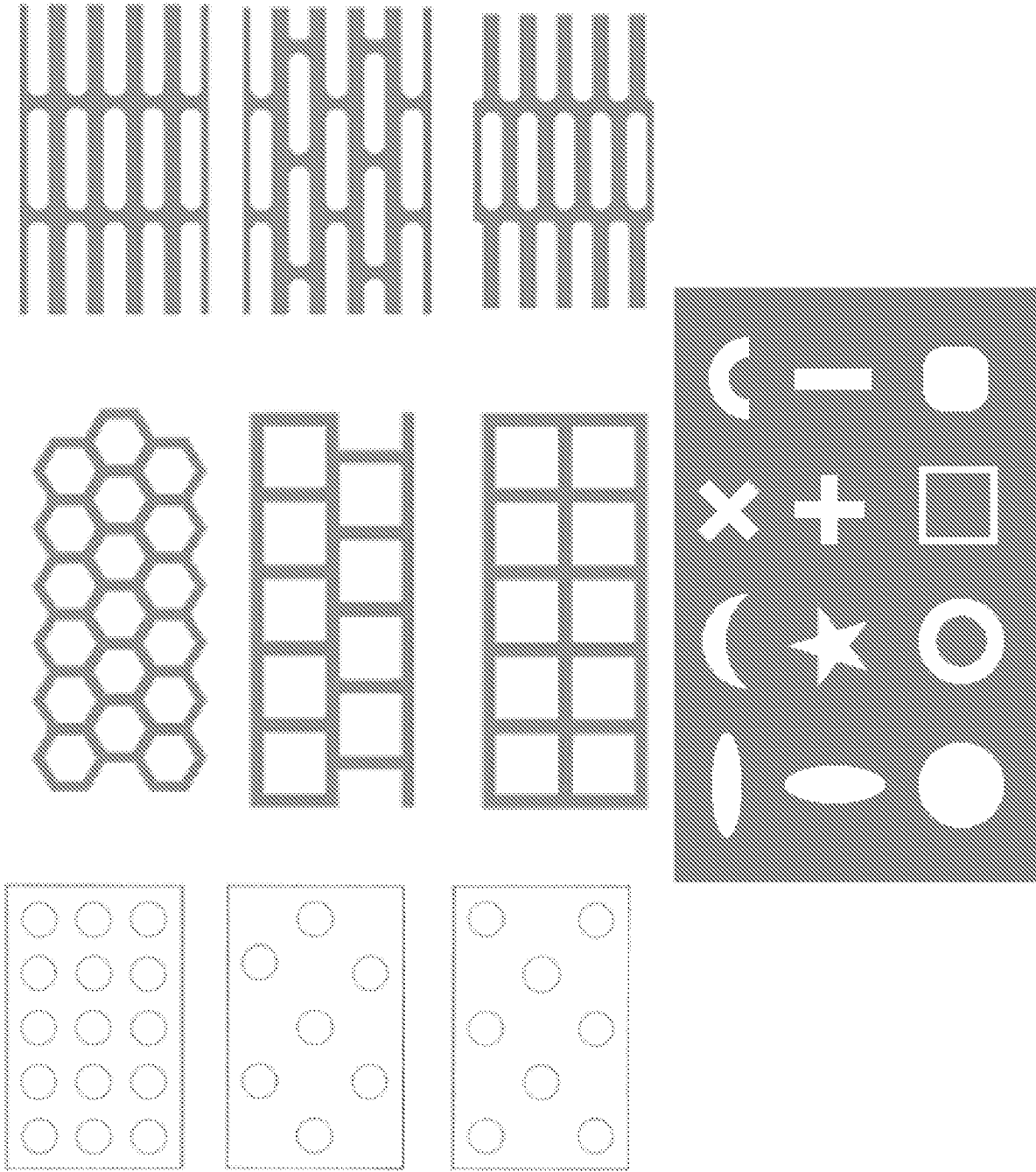
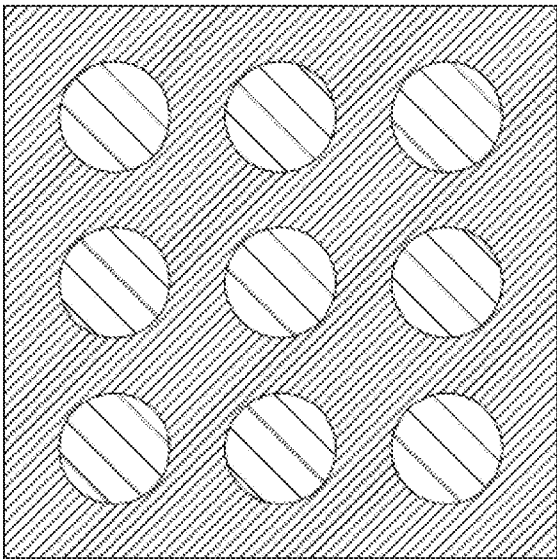
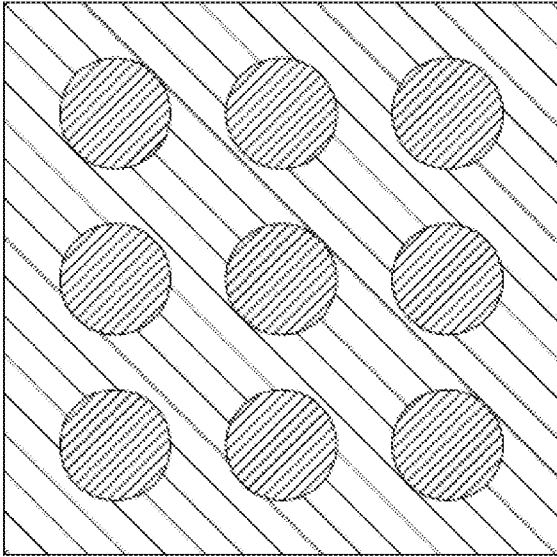

FIGURE 25



/// Electrode materials

/// Reinforcements

FIGURE 26

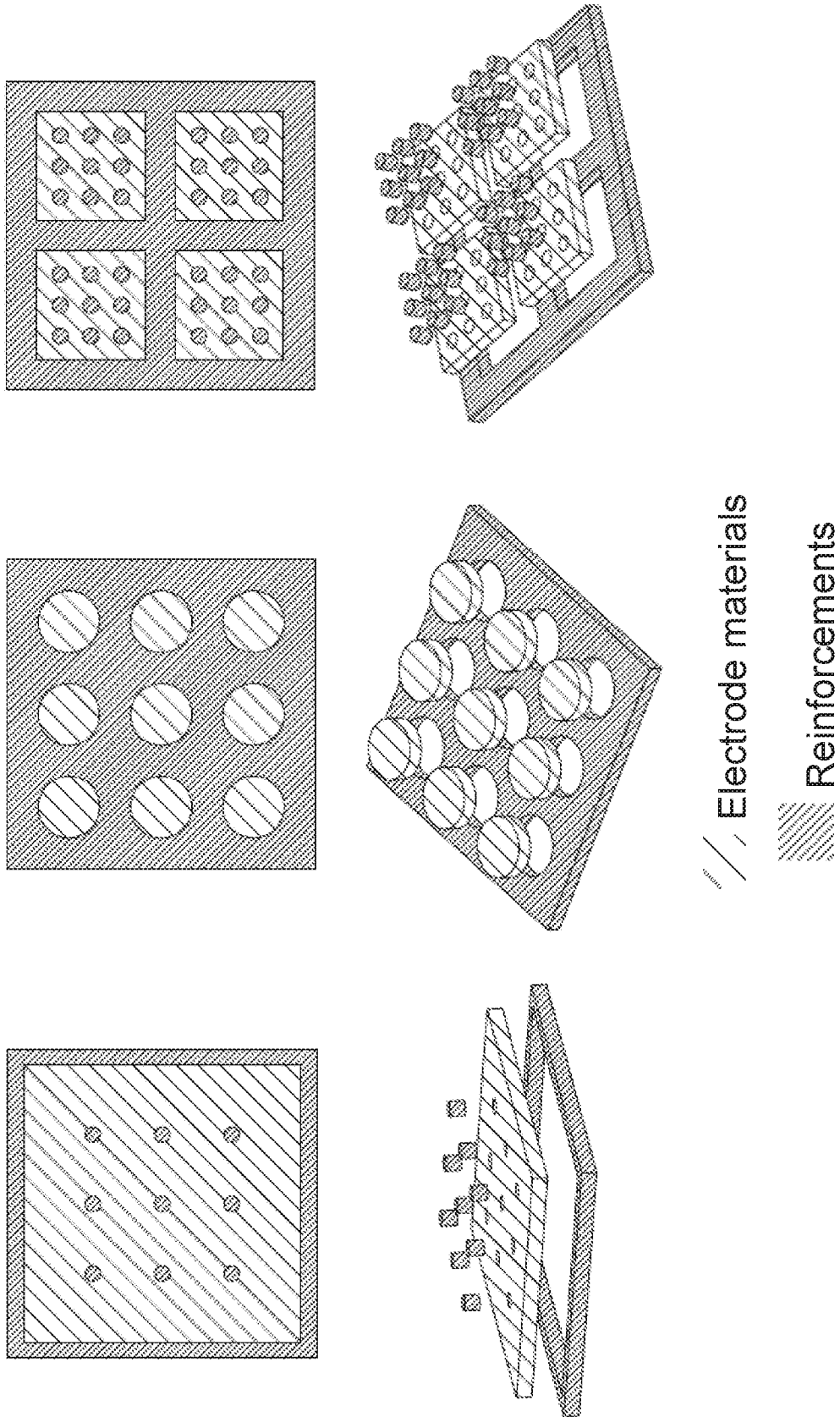

FIGURE 27

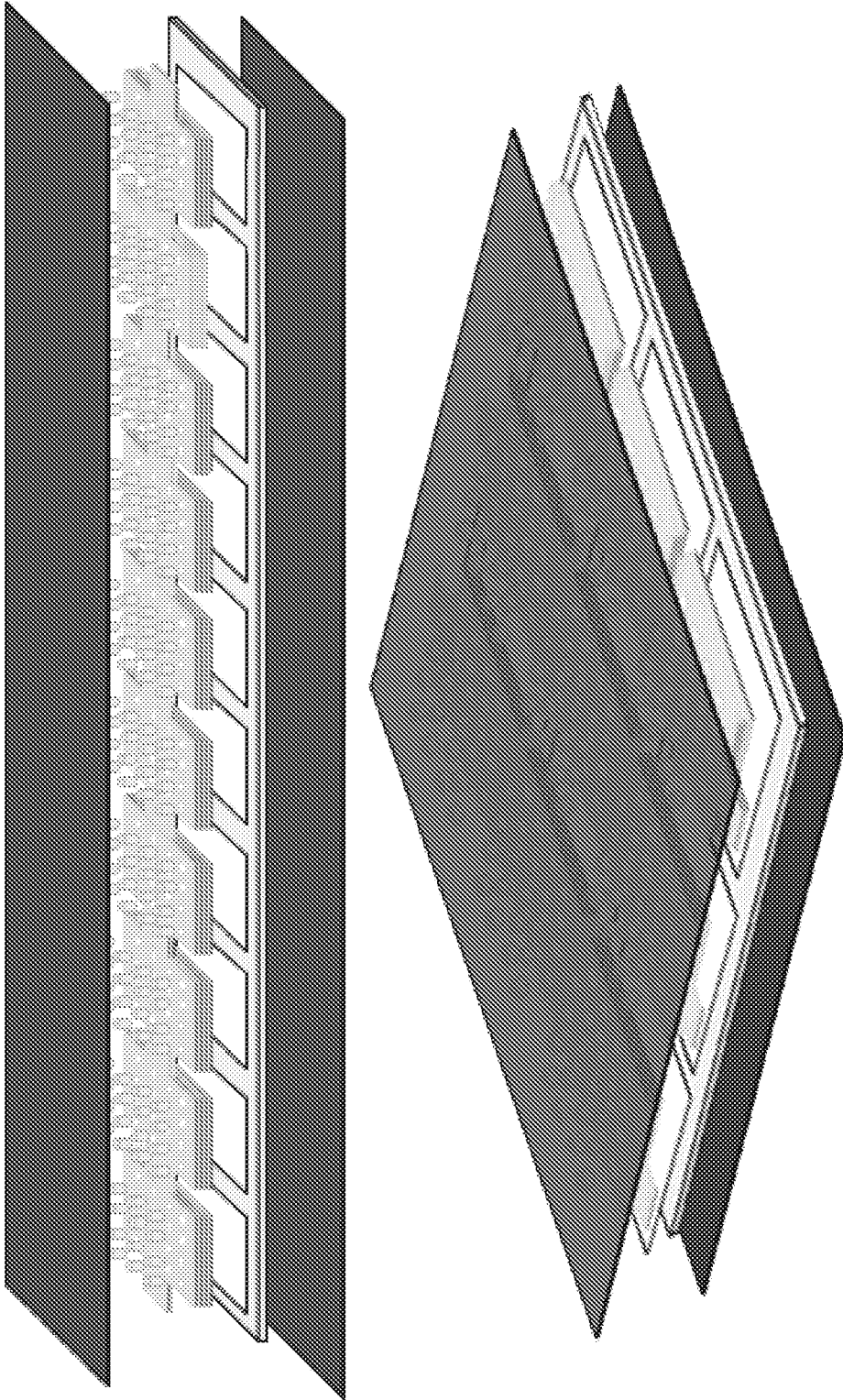

FIGURE 28

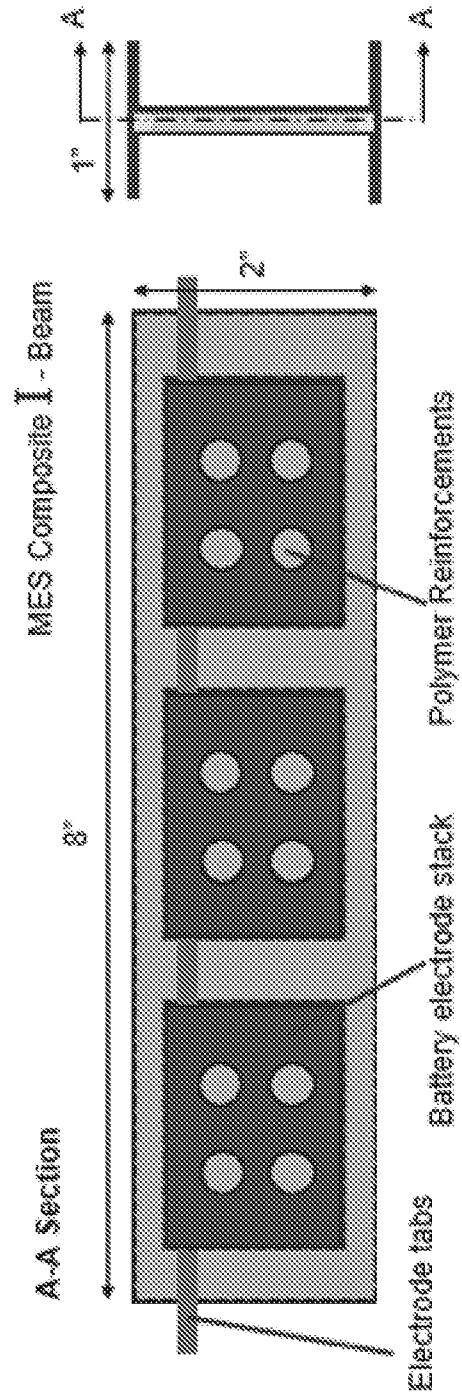
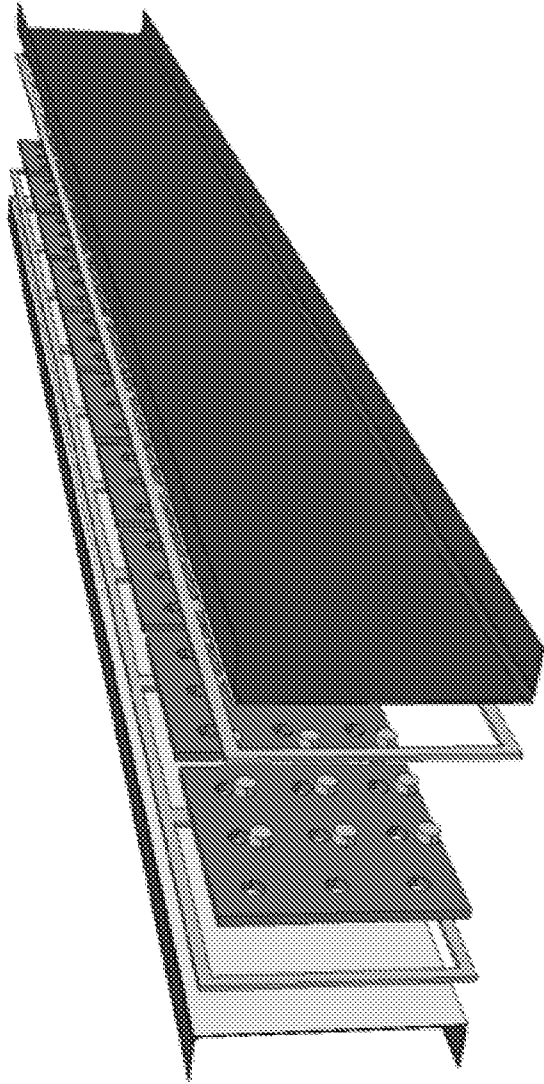

FIGURE 29

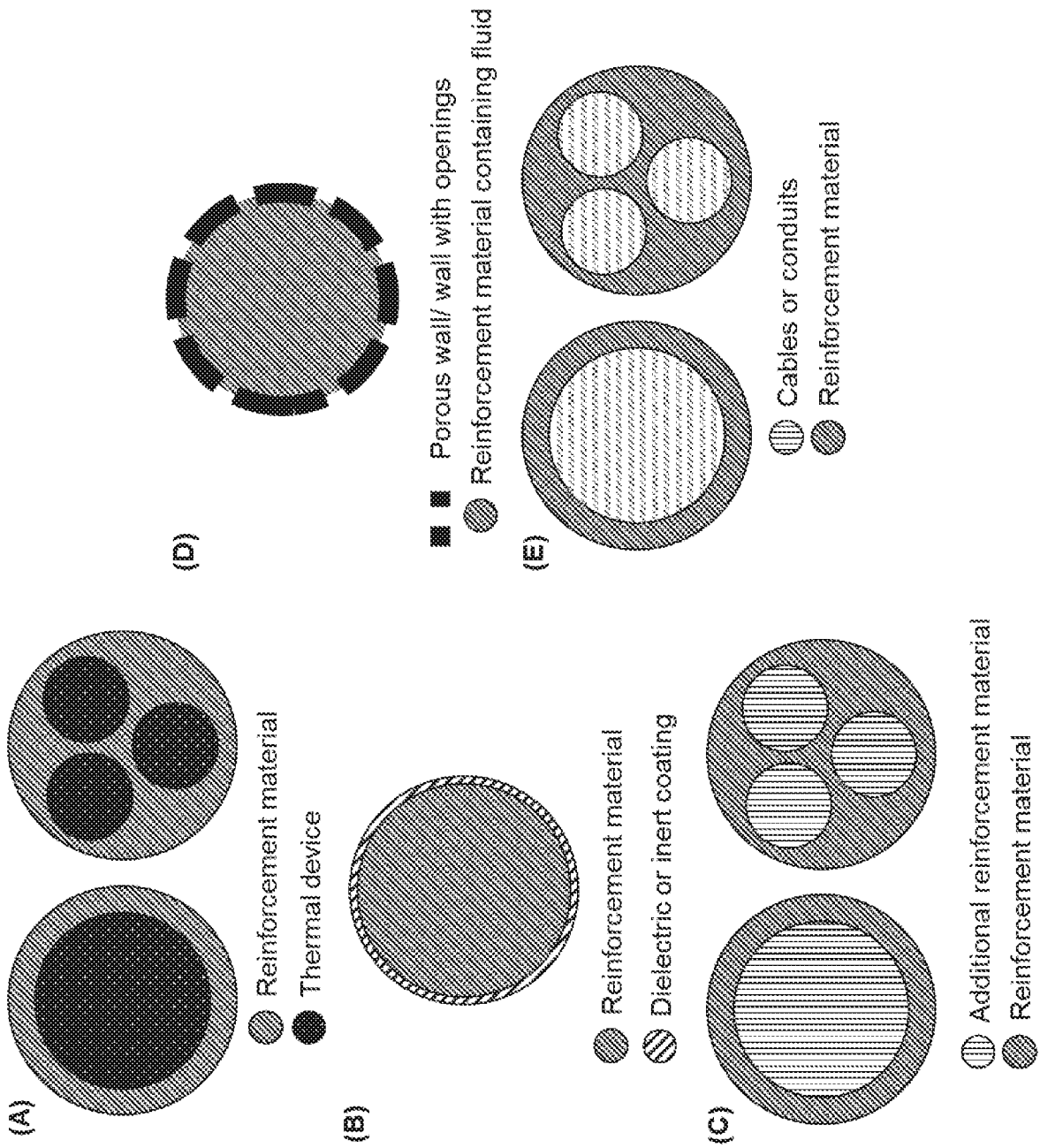
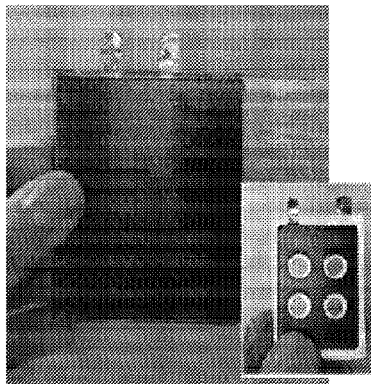
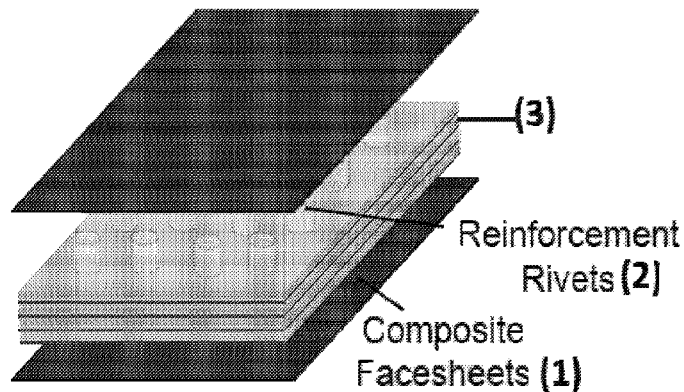

FIGURE 30

Multifunctional Energy-Storage Composites (MES Composites)



MES Composite Sample