



US00D739682S

(12) **United States Design Patent**
Peterson et al.

(10) **Patent No.:** **US D739,682 S**

(45) **Date of Patent:** **** Sep. 29, 2015**

(54) **CONTAINER**

(71) Applicant: **TARGET BRANDS, INC.**,
Minneapolis, MN (US)

(72) Inventors: **William Peterson**, Minneapolis, MN
(US); **Kent D. Katterheinrich**,
Shoreview, MN (US)

(73) Assignee: **Target Brands, Inc.**, Minneapolis, MN
(US)

(**) Term: **14 Years**

(21) Appl. No.: **29/488,061**

(22) Filed: **Apr. 15, 2014**

(51) **LOC (10) Cl.** **07-01**

(52) **U.S. Cl.**
USPC **D7/603**

(58) **Field of Classification Search**
USPC D7/601-605, 629, 584, 586, 587;
220/660, 669-673, 675, 574-575,
220/592.09, 592.01, 592.12, 592.17,
220/592.19, 592.16; 62/457.1-457.9, 371,
62/372

See application file for complete search history.

(56) **References Cited**

U.S. PATENT DOCUMENTS

| | | | | |
|--------------|---------|----------|-------|----------|
| D407,606 S * | 4/1999 | Carrere | | D7/603 |
| D407,608 S | 4/1999 | Carrere | | |
| D530,156 S * | 10/2006 | Moore | | D7/603 |
| D557,991 S | 12/2007 | Hong | | |
| D597,382 S * | 8/2009 | Bognar | | D7/624.2 |
| D651,049 S | 12/2011 | Nakagawa | | |

OTHER PUBLICATIONS

“Ceramic Beverage Tub”, printed from <http://www.ballarddesigns.com/ceramic-beverage-tub/265489?redirect=y>, publicly available at least as early as Oct. 25, 2013 (2 pages).

“Blue Stoneware Beverage Tub”, printed from www.monticelloshop.org/020569.html, publicly available at least as early as May 27, 2013, per <http://web.archive.org> (2 pages).

“Calibri Party Bucket & Wine Cooler”, printed from www.potterybarn.com/products/calibri-ceramic-beverage-party-bucket-wine-cooler/, publicly available at least as early as Sep. 18, 2013, per <http://web.archive.org> (2 pages).

“Regal Stag Silver Ice Bucket (Engravable)”, printed from www.homewetbar.com/regal-stag-silver-ice-bucket-p-3004.htm, publicly available at least as early as Jun. 14, 2013 (3 pages).

“Rhodes Party Bucket & Wine Cooler”, printed from www.potterybarn.com/products/rhodes-party-bucket-wine-cooler/, publicly available at least as early as Sep. 4, 2013, per <http://web.archive.org> (3 pages).

“Speakeasy Party Bucket Collection”, printed from www.potterybarn.com/products/speakeasy-party-bucket/?cm_src=AutoCSLPIP, publicly available at least as early as Oct. 28, 2013 (3 pages).

“Rustic Italian Ceramic Party Tub, Ivory”, printed from www.williams-sonoma.com/products/1027176/?catalogId=51&bn...%7C_Williams-Sonoma&srccode=cii_17588969&cpncode=35-90207779-2, publicly available at least as early as May 4, 2012 (4 pages).

Office Action from Canadian Patent Application No. 156,826, mailed Nov. 28, 2014 (2 pages).

* cited by examiner

Primary Examiner — Terry Wallace

(74) *Attorney, Agent, or Firm* — Griffiths & Seaton PLLC; JoAnn M. Seaton

(57) **CLAIM**

The ornamental design for a container, as shown and described.

DESCRIPTION

FIG. 1 is a top, front, perspective view of a container showing our new design;

FIG. 2 is a front view thereof;

FIG. 3 is a rear view thereof;

FIG. 4 is a right side view thereof;

FIG. 5 is a left side view thereof;

FIG. 6 is a top view thereof; and,

FIG. 7 is a bottom view thereof.

The features shown in broken lines are portions of the container forming no part of the claimed design. The long dash-short dash bolded broken lines indicate the bounds of the claimed design and otherwise form no part of the claimed design.

Applicant reserves the right to amend the claimed invention by showing in solid lines any and all features or portions thereof originally shown in broken lines and/or by showing in broken lines any and all features or portions thereof originally shown in solid lines.

1 Claim, 7 Drawing Sheets

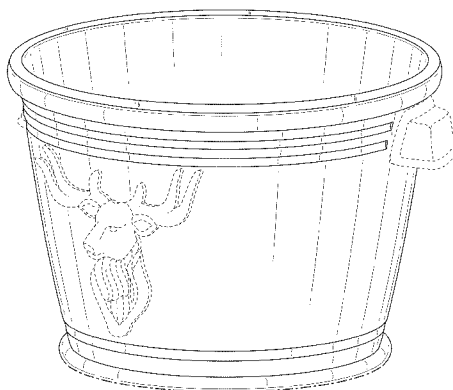

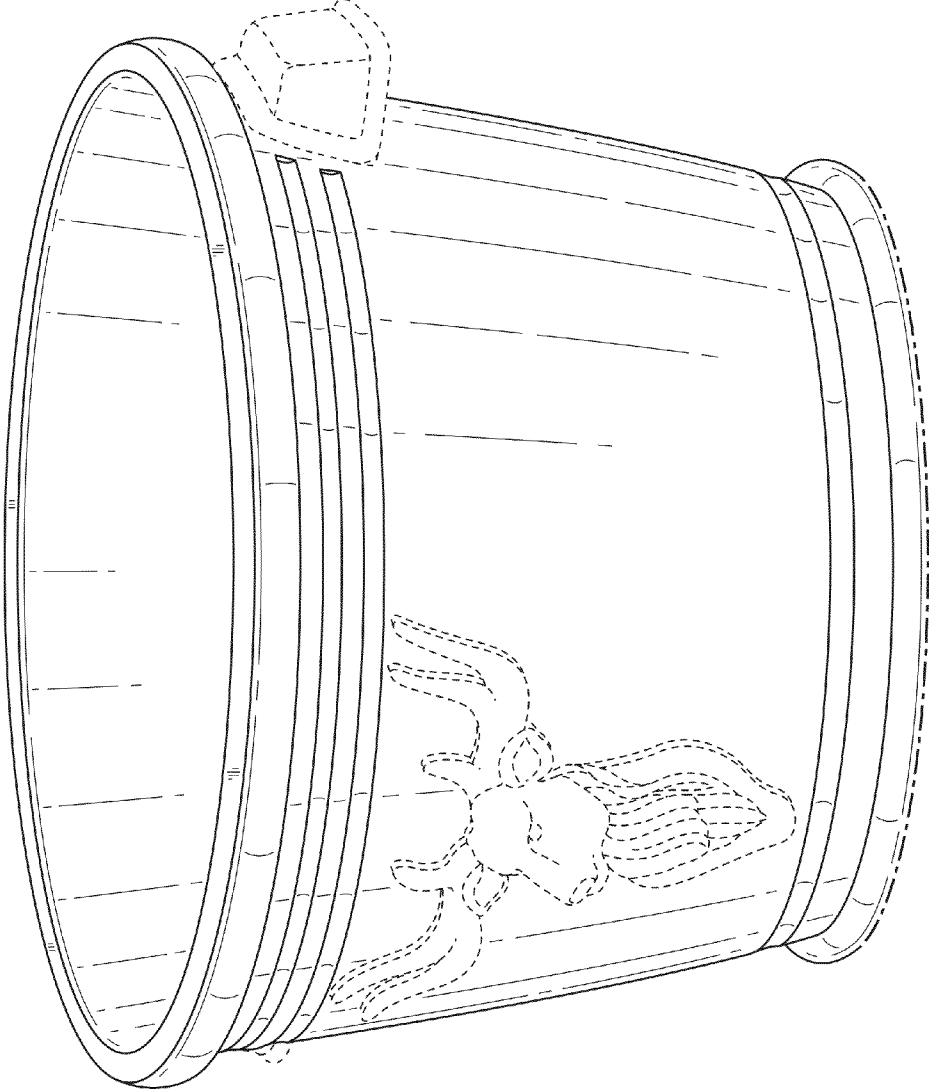

FIG. 1

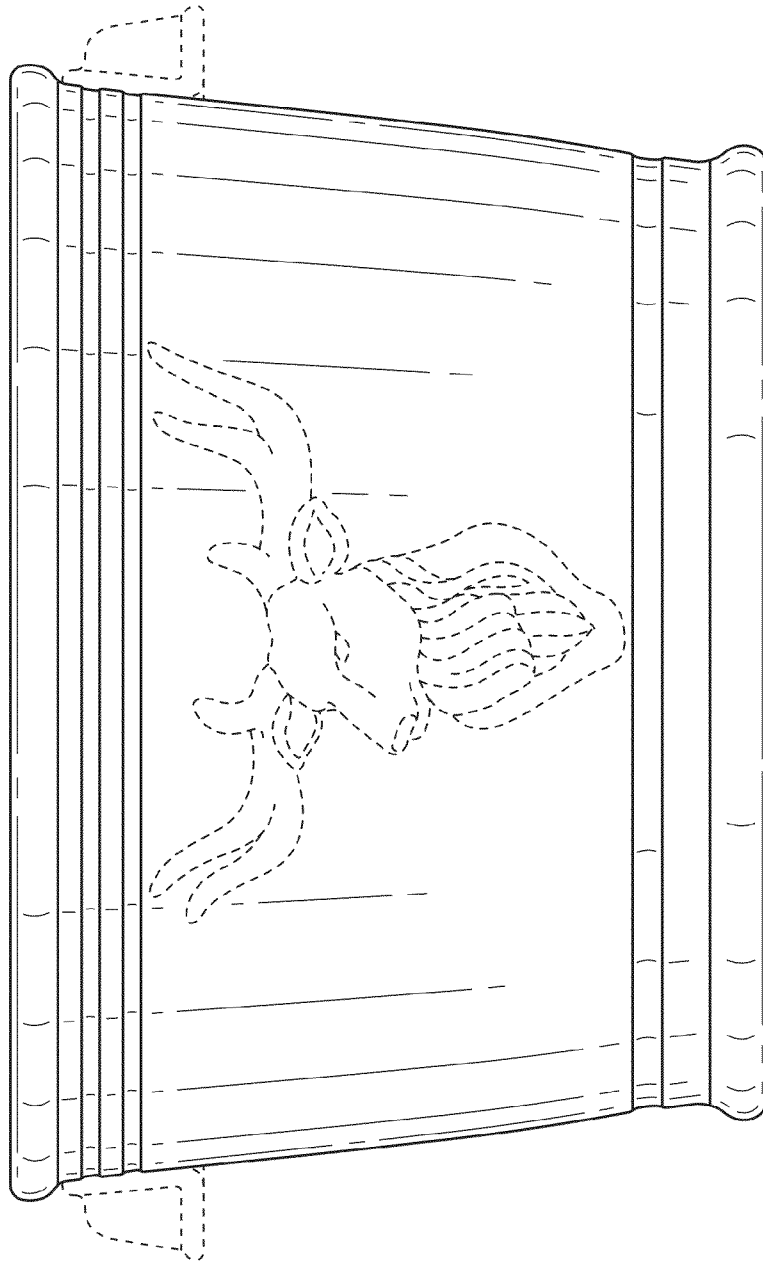

FIG. 2

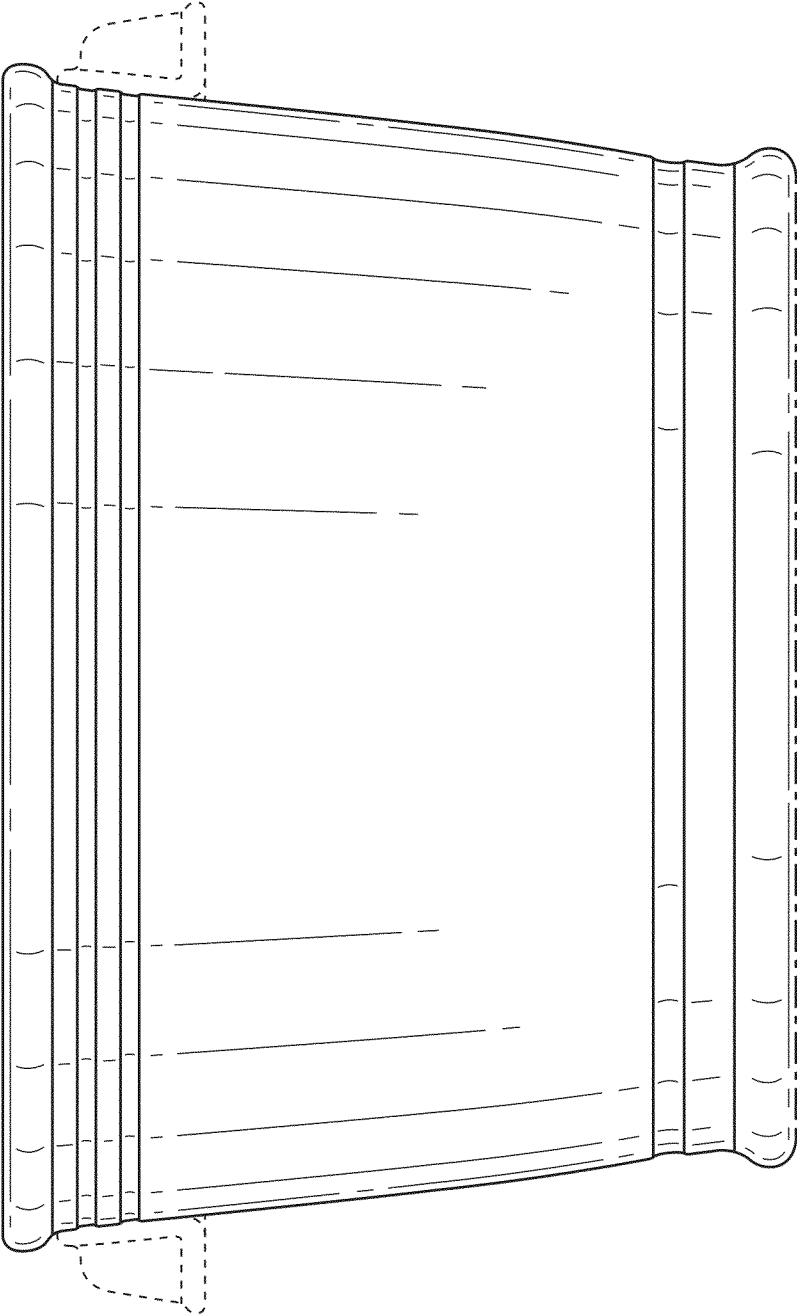

FIG. 3

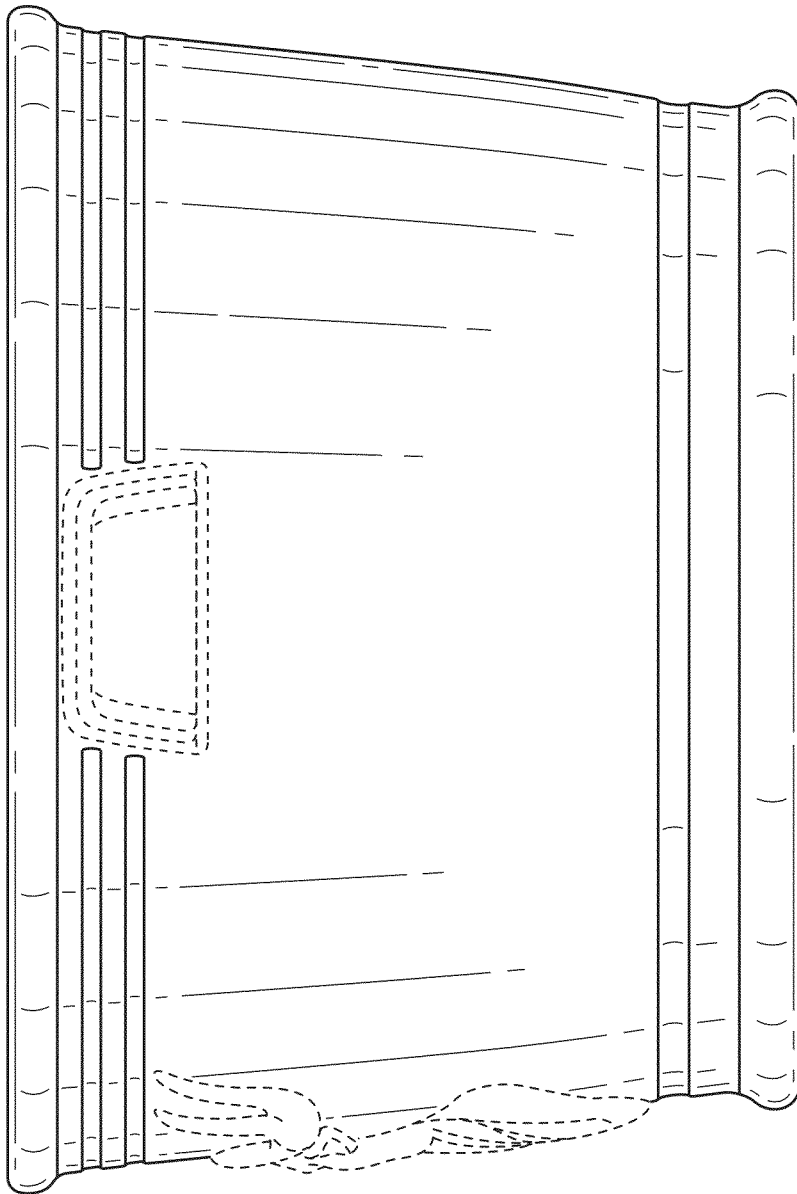

FIG. 4

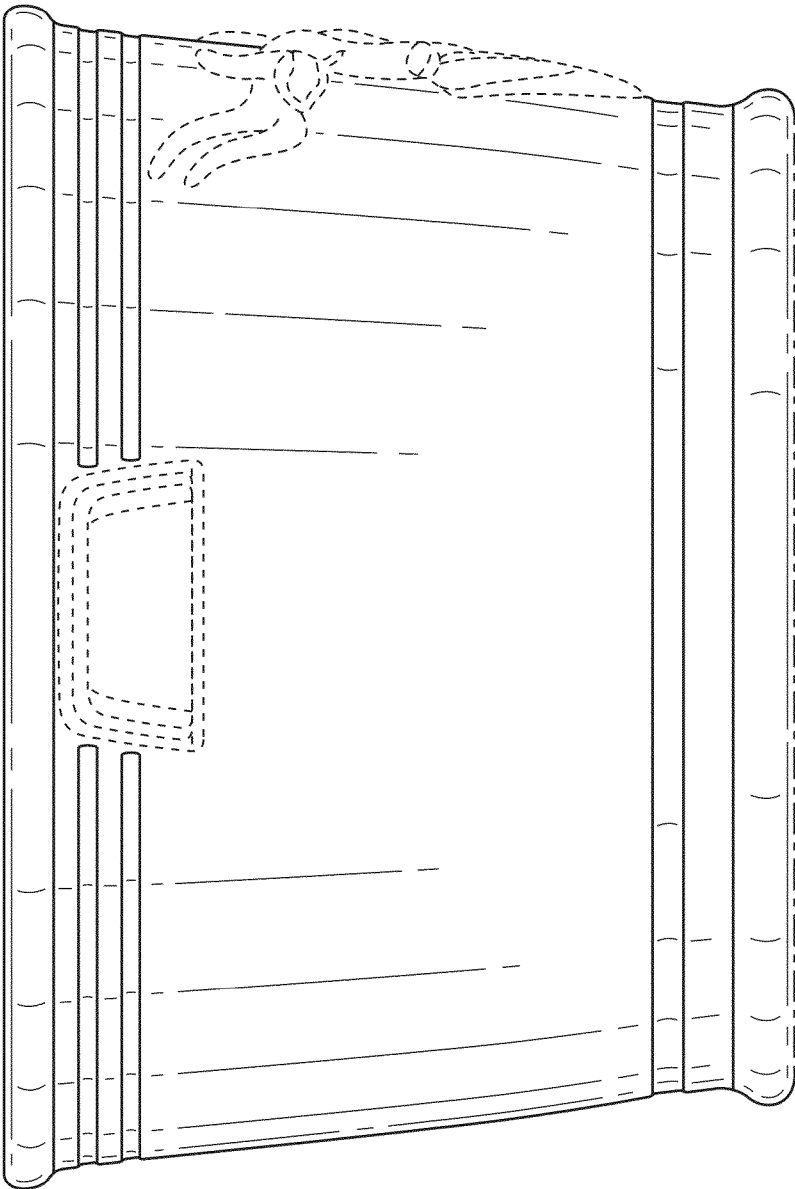

FIG. 5

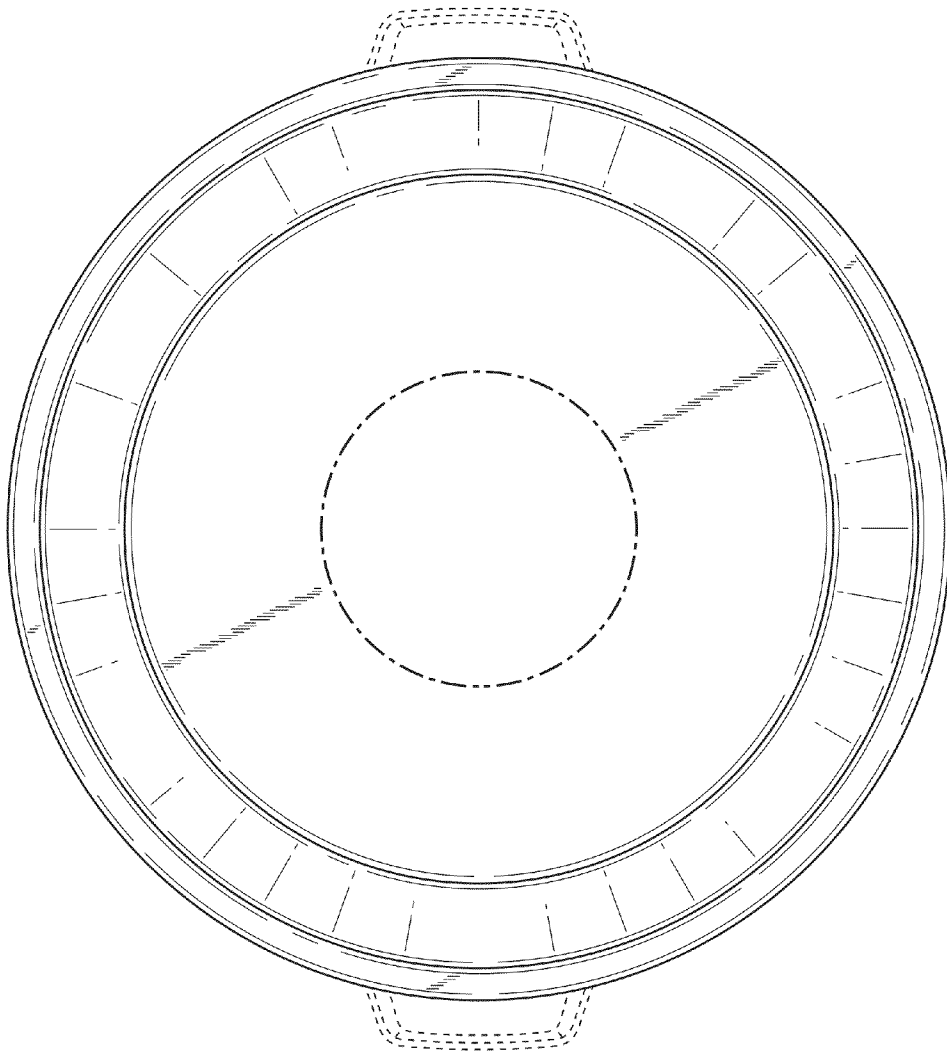

FIG. 6

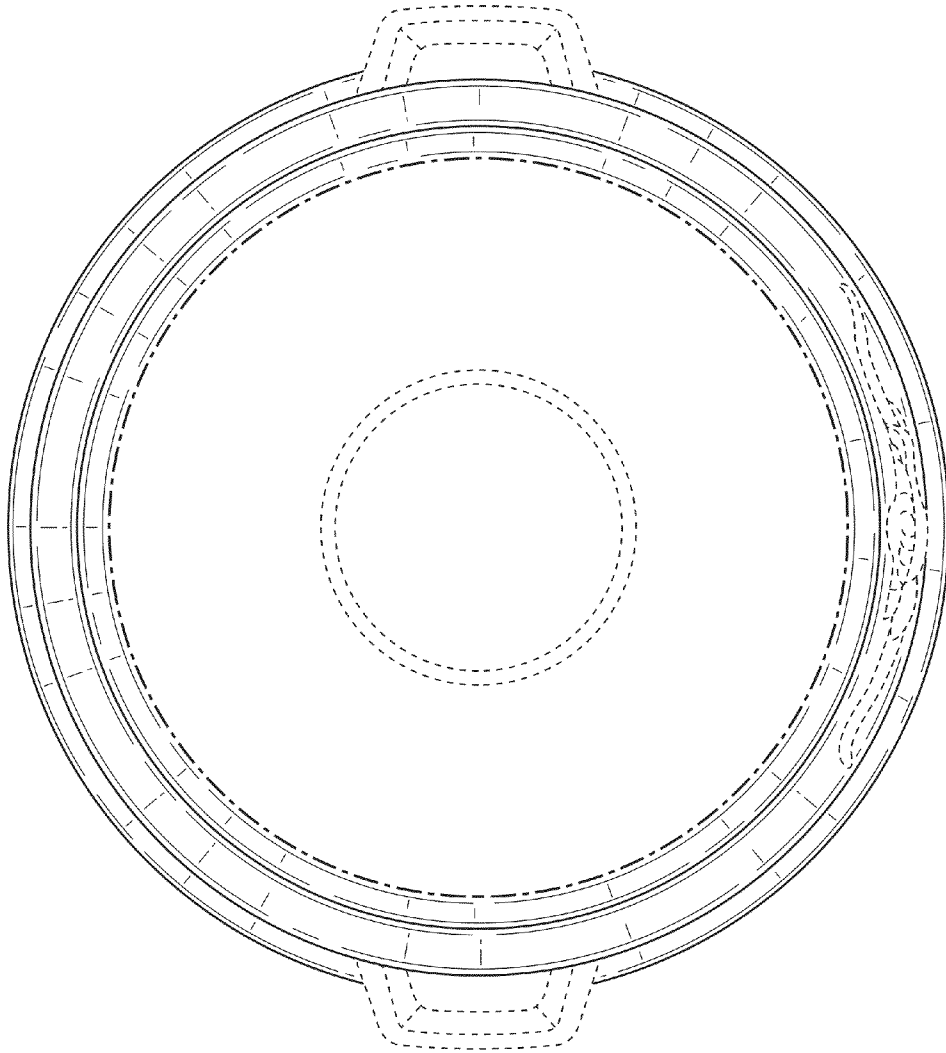

FIG. 7