

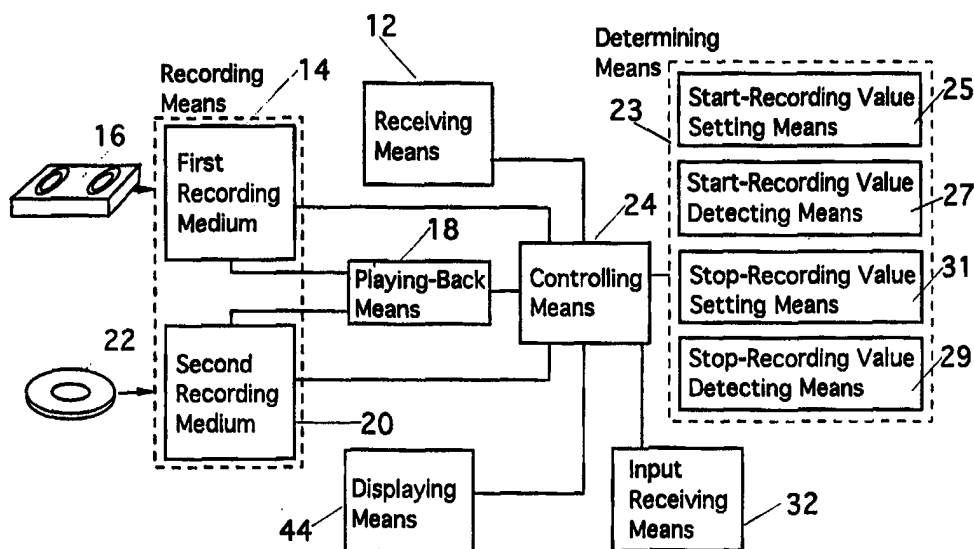

## INTERNATIONAL APPLICATION PUBLISHED UNDER THE PATENT COOPERATION TREATY (PCT)

|  |                  |  |
|--|------------------|--|
| <p>(51) International Patent Classification <sup>6</sup> :<br/><b>H04N 5/76</b></p>  | <p><b>A1</b></p> | <p>(11) International Publication Number: <b>WO 98/51076</b></p> <p>(43) International Publication Date: 12 November 1998 (12.11.98)</p>   |
| <p>(21) International Application Number: PCT/US97/18372</p> <p>(22) International Filing Date: 1 October 1997 (01.10.97)</p> <p>(30) Priority Data:<br/>08/848,895 1 May 1997 (01.05.97) US</p> <p>(71)(72) Applicant and Inventor: DANIELS, John, J. [US/US];<br/>323 Roosevelt Drive, Seymour, CT 06483 (US).</p> |                  | <p>(81) Designated States: AL, AM, AT, AU, AZ, BA, BB, BG, BR, BY, CA, CH, CN, CU, CZ, DE, DK, EE, ES, FI, GB, GE, GH, HU, ID, IL, IS, JP, KE, KG, KP, KR, KZ, LC, LK, LR, LS, LT, LU, LV, MD, MG, MK, MN, MW, MX, NO, NZ, PL, PT, RO, RU, SD, SE, SG, SI, SK, SL, TJ, TM, TR, TT, UA, UG, US, UZ, VN, YU, ZW, ARIPO patent (GH, KE, LS, MW, SD, SZ, UG, ZW), Eurasian patent (AM, AZ, BY, KG, KZ, MD, RU, TJ, TM), European patent (AT, BE, CH, DE, DK, ES, FI, FR, GB, GR, IE, IT, LU, MC, NL, PT, SE), OAPI patent (BF, BJ, CF, CG, CI, CM, GA, GN, ML, MR, NE, SN, TD, TG).</p> <p><b>Published</b><br/><i>With international search report.</i></p> |

## (54) Title: TIME-SHIFTING APPARATUS AND AUTO-EDIT SYSTEM



## (57) Abstract

A method and time shifting event recorder capable of recording portions of a time sequential signal representing an event so that a representation of the event can be produced in a time shifted manner. At any time, the user can input a pause display command, resulting in a first recorded portion of the time sequential signal to be recorded. When the viewer wishes to return to viewing the program, a resume command is played back while simultaneously recording a second recorded portion. An auto-editing device can utilize the play back capabilities of the inventive time shifting event recorder to generate a video tape (50) containing a recorded event that has been automatically edited. During the recording of an event using, for example, a video camera (64) the camera operator selects portions of the recorded event that are to be re-recorded into an edited version. During a post editing process, the selected portions are determined and only the selected portions are re-recorded into the edited version.

**FOR THE PURPOSES OF INFORMATION ONLY**

Codes used to identify States party to the PCT on the front pages of pamphlets publishing international applications under the PCT.

|           |                          |           |  |           |  |           |                          |
|-----------|--------------------------|-----------|--|-----------|--|-----------|--------------------------|
| <b>AL</b> | Albania                  | <b>ES</b> | Spain                                    | <b>LS</b> | Lesotho                                      | <b>SI</b> | Slovenia                 |
| <b>AM</b> | Armenia                  | <b>FI</b> | Finland                                  | <b>LT</b> | Lithuania                                    | <b>SK</b> | Slovakia                 |
| <b>AT</b> | Austria                  | <b>FR</b> | France                                   | <b>LU</b> | Luxembourg                                   | <b>SN</b> | Senegal                  |
| <b>AU</b> | Australia                | <b>GA</b> | Gabon                                    | <b>LV</b> | Latvia                                       | <b>SZ</b> | Swaziland                |
| <b>AZ</b> | Azerbaijan               | <b>GB</b> | United Kingdom                           | <b>MC</b> | Monaco                                       | <b>TD</b> | Chad                     |
| <b>BA</b> | Bosnia and Herzegovina   | <b>GE</b> | Georgia                                  | <b>MD</b> | Republic of Moldova                          | <b>TG</b> | Togo                     |
| <b>BB</b> | Barbados                 | <b>GH</b> | Ghana                                    | <b>MG</b> | Madagascar                                   | <b>TJ</b> | Tajikistan               |
| <b>BE</b> | Belgium                  | <b>GN</b> | Guinea                                   | <b>MK</b> | The former Yugoslav<br>Republic of Macedonia | <b>TM</b> | Turkmenistan             |
| <b>BF</b> | Burkina Faso             | <b>GR</b> | Greece                                   | <b>ML</b> | Mali   | <b>TR</b> | Turkey                   |
| <b>BG</b> | Bulgaria                 | <b>HU</b> | Hungary                                  | <b>MN</b> | Mongolia                                     | <b>TT</b> | Trinidad and Tobago      |
| <b>BJ</b> | Benin                    | <b>IE</b> | Ireland                                  | <b>MR</b> | Mauritania                                   | <b>UA</b> | Ukraine                  |
| <b>BR</b> | Brazil                   | <b>IL</b> | Israel                                   | <b>MW</b> | Malawi                                       | <b>UG</b> | Uganda                   |
| <b>BY</b> | Belarus                  | <b>IS</b> | Iceland                                  | <b>MX</b> | Mexico                                       | <b>US</b> | United States of America |
| <b>CA</b> | Canada                   | <b>IT</b> | Italy                                    | <b>NE</b> | Niger  | <b>UZ</b> | Uzbekistan               |
| <b>CF</b> | Central African Republic | <b>JP</b> | Japan                                    | <b>NL</b> | Netherlands                                  | <b>VN</b> | Viet Nam                 |
| <b>CG</b> | Congo                    | <b>KE</b> | Kenya                                    | <b>NO</b> | Norway                                       | <b>YU</b> | Yugoslavia               |
| <b>CH</b> | Switzerland              | <b>KG</b> | Kyrgyzstan                               | <b>NZ</b> | New Zealand                                  | <b>ZW</b> | Zimbabwe                 |
| <b>CI</b> | Côte d'Ivoire            | <b>KP</b> | Democratic People's<br>Republic of Korea | <b>PL</b> | Poland                                       |           |                          |
| <b>CM</b> | Cameroon                 | <b>KR</b> | Republic of Korea                        | <b>PT</b> | Portugal                                     |           |                          |
| <b>CN</b> | China                    | <b>KZ</b> | Kazakstan                                | <b>RO</b> | Romania                                      |           |                          |
| <b>CU</b> | Cuba                     | <b>LC</b> | Saint Lucia                              | <b>RU</b> | Russian Federation                           |           |                          |
| <b>CZ</b> | Czech Republic           | <b>LI</b> | Liechtenstein                            | <b>SD</b> | Sudan  |           |                          |
| <b>DE</b> | Germany                  | <b>LK</b> | Sri Lanka                                | <b>SE</b> | Sweden                                       |           |                          |
| <b>DK</b> | Denmark                  | <b>LR</b> | Liberia                                  | <b>SG</b> | Singapore                                    |           |                          |
| <b>EE</b> | Estonia                  |           |  |           |  |           |                          |

## TIME-SHIFTING APPARATUS AND AUTO-EDIT SYSTEM

### BACKGROUND OF THE INVENTION:

The present invention(s) described herein pertain to a method and time shifting event recorder apparatus for pausing the display of a received time sequential signal. More particularly, the present invention(s) pertains to a time shifting event recorder capable of arbitrarily pausing the display of, for example, a television program so as to be effective in time shifting the viewing of the program.

The present invention(s) described herein also pertains to an auto-editing device, and more particularly, to an auto-editing device for use with a video recording camera and a video recorder.

Ever since events have been transmitted to and received by devices, such as radios and televisions, people have desired to be able to pause the display of the continuous event at selectable periods. Consider the example of a program being watched on a television and a viewer leaves the room to attend to a phone call. In this case, the display of the program would preferably be interrupted so that the viewer does not miss any of it. Upon returning, it is desirable to be able to resume viewing or listening to the transmitted event from the point at which the viewer left the room.

Also, when watching television, very often the viewer would like to return to a previous period in the continuously transmitted event to review that interval again. This is conventionally possible using a recording, such as a video tape of the event. In this case, the user is able to pause the video tape at any desired time. Then, at any future time the viewer can begin playing the tape again and watch the recorded event starting from the point of time on the tape at which its play back was stopped. Or, if something of interest occurs during the viewing of the recorded event, the viewer can rewind the video tape and watch that interval over and over again. After watching this interesting interval, the viewer can allow the tape to continually play to watch the rest of the event.

However, there is no prior art device or method that allows a user to pause the display of a television show and then return to the point of departure at any time, with the time and the duration of the pause being determined at the user's command.

The Internet has recently exploded in popularity. Computer users are getting on-line to search for and download their choice of information from the large amount of information content already available. Business have realized the commercial prospects of having an on-line presence, and often provide their world wide web site address in print, radio and television advertisements. A computer user with a modem can get on-line and access the business' web site to obtain more information about a particular product that the user is interested in. This form of advertisement will most likely become more and more common as Internet use increases. However, the user must memorize or write down the advertiser's web site address, or perform a sometimes labor and time intensive on-line search to find the web site. If a television viewer wishes to access the advertiser's web site for more information, then he or she must wait

until after the program has aired if it is desired to watch the whole program. Therefore, there is a need for a time shifting event recorder that allows a viewer to temporarily pause a program, access a computer network such as the Internet, and then resume viewing the program without missing any of it.

The accepted wisdom in the art is that a video cassette recorder can be used to make a recording of a television show so that the show can be later watched by a viewer in an asynchronous manner, that is, with pauses and replays determined according to the desires of the viewer.

In accordance with the teachings of the prior art, a dual deck recorder can be used to make copies of prerecorded tapes, or possibly record two different shows at once (if two channels can be tuned in), or possibly watch one prerecorded show while taping another.

There is no prior reference that enables a television program to be viewed at a pace dictated by the viewer, even through the television program continues to be aired. No prior device allows a viewer to watch a broadcast television program during the broadcast as if it were a prerecorded tape.

On another front, the use of a video camera for recording events has become widespread. Particularly, a video camera is pervasively used in the news-gathering field to capture images of real time events for later display and broadcast. Also, due to the advent of the home video player and video camcorder, the general public now records personal events using hand-held video cameras. A video camera uses a magnetic tape to store the images of an event for later display. New video cameras are being developed that store the recorded video image as digital information.

Typically, when filming an event a conventional video camera is set to record during durations of time that not only capture a desired portion of an event, or interesting occurrence, but which also record periods of superfluous and uninteresting footage. Since an event or interesting occurrence will often happen at times which are entirely unpredictable, to capture the desired unpredictable event the video camera must continuously record the superfluous footage, or risk the chance of not capturing the desired event.

In order to concentrate and make an interesting final product, extensive editing is usually required. Typically, this editing requires post-recording viewing of the entire video tape during which time interesting moments captured on the tape are transferred to another video tape, while leaving out the uninteresting or undesired recorded portions.

#### **SUMMARY OF THE INVENTION:**

The inventions described herein is intended to overcome the drawbacks of the conventional art. In accordance with the present invention(s) a time shifting event recorder is provided capable of recording portions of a time sequential signal representing an event so that a representation of the event can be produced in a time shifted manner.

In accordance with another aspect of the present invention(s), an automatic editing device is provided for use with audio and/or video equipment, which is capable of "live" editing of an event as it is being recorded. Such an automatic editing device can utilize the play back

capabilities of the inventive time shifting event recorder to generate a video tape containing a recorded event that has been automatically edited.

In accordance with the present invention(s), a multi-featured multi-media appliance can be provided that includes at least one of:

(a) a recording device for pausing the display of a received time sequential signal on a displaying device, the recording device including recording means for recording a first recorded portion of a received time sequential signal and for recording a second recorded portion of the received time sequential signal, the second recorded portion being a different part of the received time sequential signal than the first recorded portion of the received time sequential signal; input receiving means for receiving a pause display command and a resume display command; determining means for determining the beginning of the first recorded portion; playing back means for playing back the first recorded portion and the second recorded portion; and controlling means for controlling the determining means to determine the beginning of the first recorded portion depending on the pause display command, the controlling means for controlling the recording means so that the first recorded portion is recorded depending on the pause display command, the controlling means for controlling the playing back means so that the first recorded portion is played back depending on the determining of the beginning portion by the determining means and depending on the resume display command, and for controlling the recording means so that at least a part of the second recorded portion of the different part of the received time sequential signal is automatically recorded simultaneously while at least a part of the first recorded portion of the received time sequential is being played back;

(b) an auto-editing system for use with an auto-editing device capable of recording an event on a recording medium, the auto-editing device generating a recorded event having a start-record signal recorded corresponding with at least one at least one edit-record interval corresponding to a respective selected portion of the recorded event, the auto-editing system comprising signal detecting means for detecting during an edit-recording operation each said start-record signal from the recording medium, controlling means for controlling recording means during the edit-recording operation so that a record operation to record an edited version of the recorded event dependent on each said detected start-record signal to record a copy of the recorded event having each said selected edit-record interval;

(c) a processor operated in accordance with an algorithm for restricting reception of a file from a computer network by a user's computer comprising the steps of storing file blocking information, requesting a file rating of a file from a computer network, receiving the file rating from the computer network, comparing the file rating with the file blocking information, if the file rating does not equal the file blocking information, then requesting and receiving the file from the computer network, and if the file rating equals the file blocking information, then restricting reception of the file; and

(d) a processor operated in accordance with an algorithm for control the recording of a television program via received data instructions, comprising the steps of providing access to a computer network source of program information and data instructions, providing for the

selection of a television program to record from the received program information, receiving data instructions from the computer network source depending on the selected television program, storing the data instructions, determining when to record the selected television program depending on the stored data instructions, controlling a recording apparatus to record the selected television program depending on the stored data instructions.

**BRIEF DESCRIPTION OF THE DRAWINGS:**

Figure 1(a) is a block diagram showing an embodiment of the time shifting event recorder in accordance with the present invention(s);

Figure 1(b) is a block diagram showing in more detail an embodiment of the time shifting event recorder in accordance with the present invention(s);

Figure 2 is a block diagram of another embodiment of the inventive time shifting event recorder;

Figure 3(a) is a perspective view of an embodiment in accordance with another aspect of the present invention(s) for playing synchronized recordings and for producing an automatically edited version of a recorded event;

Figure 3(b) is a perspective view of the embodiment of the present invention(s) shown in Figure 3(a), showing user definable perspectives of the synchronized recordings played simultaneously on a monitor;

Figure 3(c) is a block diagram of components of the embodiment of the invention shown in Figure 3(a);

Figure 4(a) is a block diagram of an inventive automatic edit event recording system;

Figure 4(b) is a block diagram of an inventive automatic edit play back and edited-recording system;

Figure 4(c) is a block diagram of an inventive automatic edit event recording system having a manual control button for selecting a beginning time of an edit-record interval;

Figure 4(d) is a graphic illustration showing an example of a time relationship of an inventive automatic editing operation with manual beginning time selection;

Figure 4(e) is a flow diagram of an automatic edit event recording operation in accordance with the time relationships shown in Figure 4(d);

Figure 4(f) is a flow diagram of an automatic edit play back and edited-recording operation in accordance with the time relationships shown in Figure 4(d);

Figure 4(g) is a graphic illustration showing an example of a time relationship of an inventive automatic editing operation with manual beginning time selection;

Figure 4(h) is a flow diagram of an automatic edit event recording operation in accordance with the time relationships shown in Figure 4(g);

Figure 4(i) is a flow diagram of an automatic edit play back and edited-recording operation in accordance with the time relationships shown in Figure 4(g);

Figure 4(j) is a flow chart illustrating the operation of recording an edited version from an auto-edit signal encoded master tape;

Figure 4(k) is a flow chart illustrating the operation of recording an analog edited version from an analog auto-edit signal encoded master tape wherein a digital recording medium is used to temporally store the edited version tape;

Figure 5 is a block diagram schematically illustrating the components of a multi-featured multi-media appliance in accordance with the present invention(s);

Figure 6(a) is a drawing showing a configuration of reading/writing heads of recording means associated with a same recordable disk recording medium;

Figure 6(b) is another configuration of reading/writing heads of recording means associated with a same recordable disk recording medium;

Figure 7(a) shows a block diagram of a configuration of the inventive time shifting event recorder wherein an electronic storage medium is constructed on a video card for easy assembly into media appliances and devices;

Figure 7(b) shows a block diagram of a configuration of the inventive time shifting event recorder for arbitrarily pausing the display of a video signal, such as a television program;

Figure 8 shows a flowchart of an algorithm showing the operational steps of the configuration of the inventive time shifting event recorder shown in Figure 7(b);

Figure 9 is a flowchart of an algorithm showing the operational steps of a time shifting event recorder in accordance with the present invention;

Figure 10 is a flowchart of an algorithm shown the operational steps of a time shifting event recorder used to enhance the performance of a pay-per-view system;

Figure 11(a) is a timing chart of the prior art reception and recording of a faster-than-real-time compressed file containing a pay-per-view movie, and the subsequent viewing of the movie;

Figure 11(b) is a timing chart of the reception and recording of a faster-than-real-time compressed file containing a pay-per-view movie, and the simultaneous viewing of the movie; and

Figure 11(c) is a timing chart similar to Figure 11(b) with a high compression rate for the compressed file.

#### **DETAILED DESCRIPTION OF THE INVENTION:**

A conventional television set allows a viewer to decide what to watch, but not when to watch it. Each television program is broadcasted from a television station, beamed via satellite, and/or carried over a cable, to each receiving television set in a synchronous manner. Stated otherwise, each television set that is tuned to a particular channel receives the same television program starting and ending at the same times. Those who wish to view a program must synchronize their schedules with the time of the program broadcast. Video tape recorders have become very popular devices because they let a viewer watch a program asynchronously, but only after the program has been aired. That is, a viewer can watch the recorded program at any time he or she desires. A VCR can be programmed to record a certain channel at a certain time to record a program. A viewer can then view the program at a later time by replaying the

recorded VCR tape. However, a viewer still must wait until the entire program has been received and recorded before viewing the play back from the VCR tape.

A video signal contains a large amount of information, and thus requires a recording scheme with a large storage capacity to record, for example, a television program in its entirety (as can be done using a conventional VCR). Recently developed video compression technology (such as MPEG) and recording media (such as high capacity disk drives, Jazz drive from Iomega and the like) now enables a useful amount of video information to be recorded in a random access manner. This recent technology includes other formats of video compression, as well as recordable compact disks, digital video disks, magneto-optical disks, phase change optical disks, and the like. Companies such as Sony, Hitachi and 3M are increasing the storage capacity of magneto-optical disks, and Matsushita is making advances in phase change storage technology. This newly developed technology enables storage of large amounts of video information, and can be used to enable the recording and playback features of the inventive device. Further advances in the speed and storage capacity of recordable media are expected, which could also be advantageously utilized by the present invention(s).

In accordance with the present invention(s), a viewer can pause the display of, for example a television program, at any time and for any length of time (limited by the recording capacity of the recording media). The pause can take place while the program is being aired, and the viewer can return to viewing the program from the point where the pause began, even while the program continues to be received. During the pause the viewer may replay a previously recorded portion of the program, fast forward through a recorded portion, simply take a break from viewing and/or switch to another channel. Also, the present invention(s) allows a viewer to pause the display of a program and switch to another media system, such as an Internet connection. The viewer can access information from the Internet computer network while pausing the display of a television program.

As an example of this application for the present invention(s), the time sequential signal that carries a television program usually includes commercial messages. The commercial message may include information regarding an advertiser's world wide web site, or other computer network address. The address may be included as information contained in the video vertical blanking interval (a portion of the video signal that is received during a time when the video display scanning returns to the top of the screen). This address information can be accessed so that a viewer can access the advertiser's computer network location for more information on a particular product that is described in the commercial message. The viewing of the program can be time shifted while the viewer accesses the advertiser's computer network site. Once the viewer has reviewed the computer network site, he can return to the television program without missing any of it.

The present invention(s) described herein facilitates the convergence of a bulk information transfer medium (television) and a personalized, nearly unlimited source of substantive information (the Internet) by allowing access to on-line content during the user-determined pause. Relevant on-line content can be linked to the program via information



embedded in the television signal, or, on-line content can provide a link to a related broadcast, cable or video-on-demand television program.

Referring to Figure 1(a), an embodiment of the inventive time shifting event recorder will be described. Receiving means 12 receives a time sequential signal representing an event. The time sequential signal may be transmitted as packets of compressed video and audio information. Each packet may not necessarily be received in the correct chronological order. For example, the received packets can be received and recorded out of the correct viewing sequence, with a later-viewed portion of the program being received and recorded prior to an earlier-viewed portion. Then, the program is reconstructed by replaying the video and audio information of the stored packets in the correct chronological order so that the earlier-viewed portion is played before the later-viewed portion.

In accordance with the present invention(s), a first recording means 14 records in a first recording medium 16 at least one selected portion of the time sequential signal. In other words, if the viewer of a television program were to leave the room, the first recording means 14 is activated to record that selected portion of the time sequential signal received during the viewer's absence. Upon returning, the viewer activates the playing-back means 18 to retrieve at the selectable interval (the viewer's return), the recorded selected portion of the time sequential signal recorded in the first recording medium 16 during the viewer's absence. The playing-back means 18 produces a play back signal from this recorded time sequential signal portion so that the viewer can view the television program where he or she left off. While the viewer is viewing the time shifted portion of the television program, a second recording means 20 records in a second recording medium 22 another selected portion of the time sequential signal. In other words, since the television program continues on time sequentially, while the viewer is viewing the first recorded portion recorded in the first recording medium 16, the second recording means 20 continues recording the time sequential signal at the point at which the recording by the first recording means 14 is stopped so that the signal can be played back.

After the time sequential signal recorded by the first recording means 14 has been played back (so that the viewer is able to view that portion of the television program that was aired in his absence), the playing-back means 18 retrieves the portion of the time sequential signal recorded by the second recording means 20 so that it may be played back. Thus, the continuous time sequential signal representing the event (the television program) is time shifted and the viewer views the program continuously upon returning, starting from the point in time at which the viewer first stopped viewing the program.

Controlling means 24 controls the first and second recording means 14,20 to record the respective selected portions of the time sequential signal. The controlling means 24 also controls the playing-back means 18 to retrieve at the selectable intervals the respective selected portions of the time sequential signal, so that the play back signal can be generated and a representation of the event can be produced in a time shifted manner. The time sequential signal can be a video signal or an audio signal. The recording media can be a magnetic tape, a magnetic disk, an electronic memory circuit (such as an EPROM, or other electronic storage

device) an optically recordable disk recording medium, or any recording medium now known or later developed suitable for the intended purposes described herein.

Figures 1(a) and 1(b) show an inventive recording device for pausing the display of a received time sequential signal (TSS) on a displaying device, such as a television, computer monitor, or radio. In accordance with the present invention(s) recording means 14 is provided for recording a first recorded portion of a received time sequential signal. The recording means 14 also records a second recorded portion of the received time sequential signal. Input receiving means 32 is provided for inputting a pause display command and a resume display command. The pause display command and the resume display command are instructions received from the viewer (via a remote control, voice activation mechanism, computer keyboard, or mouse, for example) to allow the control of the viewing of, for example, a television program depending on the viewer's preference.

Determining means 23 is provided for determining a beginning of the first recorded portion. The determining means 23 includes a start-recording value setting means 25 for setting a start-recording value. As will be described in more detail below, the start-recording value is utilized for determining where on the recording medium the beginning of a recorded portion of the time sequential signal is physically (or electronically) located. For example, the start-recording value may be a counter value that corresponds to where on a VCR tape or other magnetic recording tape the beginning of a recorded portion of the time sequential signal is located. The counter may be an electronic digital counter that provides a counter value signal which can be stored in a memory device, such as a RAM. Each counter value signal corresponds to a segment of the length of the VCR tape.

The counter of the VCR does not necessarily have to be used to provided the counter value. For example, The microprocessor clock can be used to count the time that a segment is recorded. A factor is determined that depends on the time it takes to rewind a given number of seconds of recorded tape by determining how long it takes for a given unit of VCR tape containing the given numbers of seconds to be rewound during the rewind operation. To get back to the beginning of a recorded portion, the time of the recorded segment is determined and this time is multiplied by the determined factor. The VCR is then controlled to rewind the video tape by the amount needed to return it to the start of the recorded segment.

Playing-back means 18 is provided for playing back the recorded portions of the time sequential signal (i.e., the first recorded portion and the second recorded portion). Controlling means 24 controls the determining means 23 to determine the beginning of the first recorded portion depending on the pause display command. The controlling means 24 may thus control the start-recording value setting means 25 depending on and in response to the received pause display command. When the pause display command is received, the start-recording value setting means 25 sets the start-recording value so that after the portion of the time sequential signal has been recorded its beginning can be located.

The controlling means 24 also controls the recording means 14 so that the first recorded portion is recorded depending on the pause display command. Once the first recorded portion of the time sequential signal has been recorded and the viewer wishes to

begin viewing the program again, the controlling means 24 controls the playing-back means 18 so that the first recorded portion is played back depending on the start-recording value, and depending on and in response to the resume display command. The controlling means 24 also controls the recording means 14 so that the second recorded portion is recorded while the first recorded portion is being played back.

In accordance with the present invention(s), the recording means 14 comprises at least one of a magnetic recording tape, a magnetic recording disk, an optical recording disk, an electronic recording circuit, and a recording medium. The recording medium may be, for example, a magnetic recording medium, an optical recording medium, a holographic recording medium, or an electronic recording medium. In the case of an electronic recording medium, a dynamic random access memory (DRAM) may be used. An example of such a DRAM is to be produced by NEC Corporation of Japan. NEC Corp. has prototyped a DRAM chip that can store more than 4 billion bits of information, enough to hold more than half-an-hour of full-motion video. Compression techniques, such as MPEG, may be employed to store a greater amount of video on such a chip. In accordance with the present invention(s), a single DRAM may be used as both the first and the second recording mediums 16,22 if it is capable of simultaneously recording and playing back information. Alternatively, two or more DRAMs can be utilized as the respective first, second (and if desired third, and so on) recording mediums. In any event, the operation of the recording and playing back of the received time sequential signal will be controlled as described herein to enable a viewer to arbitrarily pause the display of, for example, a received television program, and then later return to the viewing of the program without missing any of it and even while the rest of the program continues to be received. The DRAM may be used as a buffer memory to store a portion of the time sequential signal to allow a non-random access recording medium, such as a conventional VCR video tape to be employed as either or both of the first and the second recording mediums 16,22. In place of the DRAM, an other random-accessible data storage device can be used, such as a hard drive, removable cartridge drive, holographic memory, etc.

The use of other recording media, such as optical or magnetic disks, electronic memory, tape, etc. may each utilize different mechanisms for determining the beginning and ending of the recorded portions of the time sequential signal. The type of start-recording value setting means 25 utilized in accordance with the present invention(s) will depend upon the type of recording means 14 utilized. However, it is important to note that in accordance with the present invention(s) the recording means 14 utilized may be comprised of two or more different types of recording media, such as a VCR tape and an optical disk. The inventive recording device can be utilize in conjunction with a VCR tape recorder so that the necessary component parts (recording/play back head, motor 45, circuitry) of the inventive recorder are reduced while still allowing the unique and useful functionality of pausing the display of a time sequential signal on a displaying device 44, such as a television, depending on the viewer's preference. The start-recording value comprises at least one of a tone signal, a counter value, file allocation table address, and a location on a recording medium.

In accordance with the present invention(s), the determining means 23 may include stop-recording value setting means 31 for setting a stop recording value. The stop-recording value indicates where the end of each recorded portion of the time sequential signal is located on the recording medium. The invention further includes stop-recording value detecting means 29 for detecting the stop-recording value. The stop-recording value setting means 31 may comprise one of a tone signal generator, a counter, a file allocation address generator, and a recording medium location address storing means. The stop-recording value may comprise at least one of a tone signal, a counter value, a file allocation table address, and a location on a recording medium.

Stated otherwise, the inventive apparatus for pausing the display of a received time sequential signal includes recording means 14 for recording a first recorded portion of a received time sequential signal and for recording a second recorded portion of the received time sequential signal. Input receiving means 32 inputs a pause display command and a resume display command. Determining means 23 determines the beginning of the recorded portion. Playing-back means plays back the first recorded portion and the second recorded portion in a time-shifted manner. In accordance with the present invention(s), controlling means 24 controls the determining means 23 to determine the beginning of each recorded portion depending on the pause display command. When the pause display command is received, the determining means 23 makes an indication of the physical or electronic location of the beginning of the recorded portion. This indication (start-recording value) is used for finding where each recorded portion begins. The physical location of the beginning of each recorded portion may be, for example, a segment of a recording tape, or a sector and/or track of a recording disk, etc. The electronic location may be an address of a memory circuit, etc. The controlling means 24 controls the recording means 14 so that the first recorded portion is recorded depending on the pause display command. When the pause display command is received, the recording means 14 begins recording a recorded portion of the time sequential signal. The controlling means 24 also controls the playing-back means so that the first recorded portion is played back depending on the beginning determined by the determining means 23 and depending on the resume display command. The controlling means 24 also controls the recording means 14 so that the second recorded portion is recorded simultaneously while the first recorded portion is being played back. The recording of the second recorded portion depends on the received resume display command, since after taking an initial break when the viewer wishes to resume viewing the program, the viewer inputs the resume display command to the controlling means 24 (via remote control, voice activation circuitry, keyboard, mouse, or other input device). The first recorded portion is then played back, while the second recorded portion of the time sequential signal is recorded.

In accordance with the present invention(s), the controlling means 24 includes determining means 23 for determining if the ending of the first recorded portion has been played back. As long as the ending of the first recorded portion has not been played back, then the controlling the playing-back means continually plays back the first recorded portion of the time sequential signal, while simultaneously recording the second recorded portion of

time sequential signal. If the ending of the first recorded portion has been played back, the controlling means 24 is effective for controlling the recording means 14 for recording an ending of the second recorded portion of the time sequential signal on the first recording medium 16. Then, the controlling means 24 controls the playing-back means for playing back the second recorded portion of the time sequential signal using the second start-recording value to determine the beginning of the second recorded portion.

In accordance with the inventive apparatus, the start-recording value setting means 25 may also be effective in setting a third start-recording value, a fourth start-recording value and so on, allowing the viewer to take any number of breaks in the viewing of the continuously received time sequential signal by recording third, fourth, etc. recorded portions that are played back in a time shifted manner. In accordance with the present invention(s), time shifting is defined as allowing a viewer to view a conventionally synchronous program in an asynchronous manner.

In the case of a third recorded portion, for example, the recording means 14 records a beginning of a third recorded portion of the time sequential signal on the first recording medium 16. The third recorded portion can be recorded on a third recording means 14, or the first and the third recording means 14 can be one in the same. If the first recorded portion has already been played back, then the third recorded portion can be recorded over it, or at least a portion of the third recorded portion can be recorded on a different location of the recording medium holding the first recorded portion. The controlling means 24 controls the determining means 23 to be effective for determining if the ending of the second recording portion has been played back. If the ending of the second recorded portion has not been played back, then the controlling means 24 controls the playing-back means for continuing playing back the second recorded portion of the time sequential signal, while simultaneously recording the third recorded portion of the time sequential signal. If the ending of the second recorded portion has been played back (i.e., the second stop-recording value is detected) then the controlling means 24 controls the recording means 14 to record an ending of the third recorded portion of the time sequential signal on the first recording medium 16. Then, the controlling means 24 controls the playing-back means to play back the third recorded portion of the time sequential signal using the third start-recording value to determine the beginning of the third recorded portion, and so on, playing back the recorded portions in the order that they were recorded, while allowing the viewer to pause the display, rewind and review, fast forward, etc., making viewing of the program asynchronous and under the complete control of the viewer.

The determining means 23 further includes stop-recording value setting means 31 for setting a first stop-recording value for determining the ending of the first recorded portion. In this case, the determining means 23 includes means for determining if the ending of the first recorded portion has been played back by detecting the first stop-recording value.

In accordance with the inventive apparatus, the determining means 23 includes means for determining if the ending of the first recorded portion has been played back. If the ending of the first recorded portion has not been played back, then the controlling means 24 controls the

determining means 23 to determine if a viewer selected function is received. The viewer selected function may be, for example, rewinding, fast forward, stop, etc.

If the viewer selected function is received, then the function is performed while simultaneously continuing to record the second recorded portion (or the next recorded portion from the recorded portion that is being played back) of the time sequential signal. If the viewer selected function instruction is not received, then the controlling means 24 controls the playing-back means to continue playing back the first recorded portion of the time sequential signal, while the recording means 14 simultaneously continues to record the second recorded portion of the time sequential signal. The viewer can arbitrarily choose to review a portion of the program that has already been viewed by rewinding or otherwise returning the play back from the recording medium to that portion of the program and letting it play again. While the rewinding and replaying of the recorded portion is taking place, the program (which continues to be aired) is simultaneously and continuously recorded on, for example, the second recording medium 22 so that the viewer does not miss any of the program. Further the viewer can fast forward through commercials, or the commercials may be blanked out by detecting the information of the vertical blanking interval from the video signal.

If the ending of the first recorded portion has been played-back, then the controlling means 24 controls the recording means 14 to record an ending of the second recorded portion of the time sequential signal on the second recording medium 22. Then, the controlling means 24 controls the playing-back means to play back the second recorded portion of the time sequential signal using the second start-recording signal value, in a manner similar to the playing back of the first recorded portion.

As shown in Figure 1(b), the controlling means 24 may include a microprocessor that is preset to control the performance of the operations of the inventive method as described herein. Recording means 14 records a recorded portions (first recorded portion, second recorded portion, and so on) of a received time sequential signal. The recording means 14 includes a recording/playback head 21 to magnetically record the received portion of the time sequential signal on a recording medium, such as a VCR tape. The recording means 14 also includes a motor 45 for advancing the recording medium during the recording process. The controlling means 24 controls the recording means 14 by appropriately actuating record switches 39 that activate the recording/play back head 21 and the motor 45 to effect the recording process. In the configuration shown in Figure 1(b), the recording means 14 is effective for recording on a first recording medium 16 and on a second recording medium 22, although, as described herein one or more recording media may be utilized, depending on the configuration of the inventive recording apparatus.

Input receiving means 32 are provided for inputting a pause display command and a resume display command. The input receiving means 32 allows the viewer to asynchronously determine the viewing of the received program, and allows the viewer to input selected functions, such as rewind, fast forward, stop, play, pause, etc. Determining means 23 determines the beginning of the each recorded portion, and playing back means 18 for plays back the recorded portions of the time sequential signal. The determining means 23 includes

start-recording value setting means 25 for setting a start-recording value, and start-recording value detecting means 27 for detecting the set start-recording value. The determining means 23 may also include stop-recording value setting means 25 for setting a stop-recording value and stop-recording value detecting means 29 for detecting the stop-recording value.

The playing back means 18 includes the recording/playback head and the motor 45 for advancing the recording medium during the playing back process. The controlling means 24 controls the playing back means 18 by appropriately actuating play switches 41 that activate the recording/play back head 21 and the motor 45 to effect the playing back process. In the configuration shown in Figure 1(b), the playing back means 18 is effective for playing back recorded portions from a first recording medium 16 and from a second recording medium 22, although, as described herein one or more recording media may be utilized, depending on the configuration of the inventive recording apparatus.

The controlling means 24 controls the determining means 23 to determine the beginning of the first recorded portion depending on the pause display command. The controlling means 24 also controls the recording means 14 so that the first recorded portion is recorded depending on the pause display command. The controlling means 24 further controls the playing back means 18 so that the first recorded portion is played back depending on the determining of the beginning portion by the determining means 23 and depending on the resume display command. In addition, the controlling means 24 controls the recording means 14 so that the second recorded portion is recorded while the first recorded portion is being played back.

The controlling means 24 controls the start-recording value setting means 25 to set the start-recording value depending on the pause display command, and the controlling means 24 controls the playing back means 18 so that the first recorded portion is played back depending the start-recording value and the resume display command.

In accordance with the present invention(s), the recording means 14 comprises at least one of a magnetic recording tape, a magnetic recording disk, an optical recording disk, an electronic recording circuit and a recording medium. The stop-recording value setting means 25 comprises at least one of an audio signal generator, a counter, a file allocation table address generator, and a recording medium location address storing means. The stop-recording value comprises at least one of an audio signal, a counter value, a file allocation table address and a location on a recording medium.

The controlling means 24 controls the playing back means 18 and the recording means 14 to appropriately control the recording/play back head 21 and the motor 45 by controlling the actuation of switches (rewind switch 33, fast forward switch 35 and play switch 41), as well as the record switch 39 and the play switch 41. The time sequential signal is received by the receiving means 12 and sent to, for example, a video signal switch 43, which is under the control of the microprocessor of the controlling means 24. When the time sequential signal is being viewed as it is received (like the conventional manner), then the video signal switch 43 is controlled to send the received time sequential signal to the displaying means 44. When viewing of the time sequential signal is being time shifted, the video signal

switch 43 is controlled by the microprocessor to transfer the received time sequential signal to the recording means 14.

Referring now to Figure 2, an embodiment of the inventive time shifting event recorder for displaying a time shifted representation of an event on a display device is shown. Receiving means 12, such as an aerial antenna 30 for receiving a broadcast signal or a cable coaxial receiver, receives a time sequential signal representing an event (such as a television program). At least one recording means 40 records in a respective recording medium at least one respective selected portion of the time sequential signal. Playing-back means 18 retrieves at respective selectable intervals each respective selected portion of the time sequential signal recorded in each recording medium, and generates a respective play back signal dependent thereon. Controlling means 24 controls each recording means to record each respective selected portion of the time sequential signal. The controlling means 24 also controls the playing-back means 18 to retrieve at each respective selectable interval each respective selected portion of the time sequential signal, so that the playing-back means 18 generates each respective play back signal. Thus, a representation of an event can be produced in a time shifted manner (as described above with reference to Figure 2(a) and 2(b)).

In this embodiment of the present invention(s), as shown in Figure 2, supplying means 42, controlled by the controlling means 24, supplies at least one of the respective play back signals and a current portion of the time sequential signal to a display device 44 simultaneously so that at least one time shifted representation of the event can be displayed simultaneously with a current representation of the event on the display device. In other words, a time shifted event representation TSER can be displayed at one portion of a television screen while a current event representation CER is displayed at another portion of the television screen. In this way, the viewer can choose to recall and review again a selected portion of the television program while continuing to view the current event representation in real time.

In accordance with the present invention(s), supplying means 42 controlled by the controlling means 24 supplies at least two of the respective play back signals to a display device simultaneously so that at least two time shifted representations of the event can be displayed simultaneously on the display device. In other words, in accordance with one embodiment of the present invention(s) the time sequential signal of an event, such as a television program, is recorded as shown by way of example in Figures 2(a) and 2(b). At the user's option, two or more portions of the event can be replayed simultaneously and viewed by the viewer on a display device 44, such as a television set. As with the other embodiments, each recording medium may be a magnetic tape, magnetic disk, electronic memory circuit (such as an integrated circuit device disposed on a silicon chip), an optically recordable disk or other suitable recording medium. It is particularly noted that various means for recording information are being constantly developed. Therefore, the present invention(s) is intended to include the use of such information storage devices whether currently known or developed at such future time. As with a previously described embodiment, in accordance with the embodiment shown in Figure 2, each recording medium can be a portion of a recordable disk so that each recording means writes to and reads from the same recordable disk. Alternatively,



each recording medium can comprise a portion of memory of a same electronic memory circuit. In this case, each recording means stores information on a same electronic memory circuit. Furthermore, as with the other embodiments, each recording means may record the time sequential signal as digital data, analog data or the like.

Figure 3(a) is a perspective view of an embodiment of the present invention(s) that utilizes a record/play back system 48 of the configuration of the inventive time shifting event recorder shown, for example, in Figure 4(b) in conjunction with a VCR 50 (or other storage device) to play back and record onto a single videotape 52 the program temporarily stored non-continuously on the two recording media 14,16. In this use, the inventive time shifting event recorder is used to play back a correctly sequenced continuous version of a recorded event for storage on a single recording means, such as a videotape 52 recorded by a VCR 50. Thus, the viewer can permanently store the recorded event for later viewing, allowing the dual recording capabilities of the inventive time shifting event recorder to be used again for controlled viewing of another program, without losing the program previously recording in a time shifting manner on the two recording media 14,16.

In accordance with another aspect of the present invention(s), the dual play back capability of the inventive time shifting event recorder is used for playing synchronized recordings for producing an automatically edited version of a recorded event. A recorded event is stored on at least two synchronized recorded tapes 14,16. The synchronized recorded tapes 14,16 store the recorded event captured from different respective perspectives (as described below with reference to Figures 12(a)-16(c)). Figure 3(a) shows the inventive time shifting recorder and a conventional VCR 50 used to play back and record the two synchronized tapes to produce an automatically edited version containing both perspectives with synchronized timing. The video signal from both synchronized recorded tapes 14,16 is controlled (as will be described below) so that the event is recorded onto an edit-recorded tape (videotape 52) with a correct sequence. For example, the recorded event may contain a scene of dialogue between two actors. As a first alternative, a first synchronized recorded tape 14 may have a perspective of one actor, while a second synchronized recorded tape 16 may have a perspective of another actor. During play back of the scene from the two synchronized recorded tapes 14,16, the viewer can choose at any time between a variety of viewing options, such as switching between the two actors during the dialogue, or using a split screen (picture-in-picture) display of both actors, etc. For example, the first synchronized recorded tape 14 may have a perspective switching between a close-up of each actor as he speaks during the dialogue, while the second synchronized recorded tape 16 may have a perspective viewing both actors at one.

Figure 3(b) is a perspective view of the embodiment of the present invention(s) shown in Figure 3(a), showing user definable perspectives of the synchronized recordings played on a monitor 44. In the example given above, a first perspective 54 is obtained from a first synchronized recorded tape 14 and shows the speaking actor in the scene of dialog. A second perspective 56 is obtained from the second synchronized recorded tape 16 and shows the listening actor. The viewer can choose between the two perspectives, or as shown, can view

both perspective in a split screen display. Also, a videodisk can be used to store more than one perspective since the rapid access time of the videodisk will not interfere with the continuity of the displayed recorded event. A lag time will be caused by the access to a new selected perspective (which will require searching a correct synchronization signal from the disk for the selected perspective). However, by using two or more disks, this lag time will have little or no effect on viewing. A perspective from one disk can be displayed during the search for the synchronization signal for the selected perspective from the other disk. Also, two or more read/write heads can be used to retrieve the selected perspectives from a single disk.

Figure 3(c) is a block diagram of elements of the play back components for viewing synchronized recorded tapes 14,16. In the case of continuously played synchronized recorded tapes 14,16 (or randomly accessible disk storage), first play back means 58 and second play back means 60 are controlled by a controller 62 to generate a time synchronized video signal from the respective first and second synchronized recorded tapes 14,16. The controller 62 receives a synchronization signal recorded or otherwise associated with each of the tapes to maintain the synchronicity of the different perspectives of the recorded event. A remote signal detector 63 receives signals from a viewer-controlled remote control, and these signals are sent to the controller. The controller 62 controls switching means 61 in response to the remote signal so a selected video signal is generated. The selected video signal may include the perspective obtained from either the first and second synchronized video tape 14,16, or a combination of the perspectives in a split screen display. Also, either perspective can be fast forwarded or rewound for controlled viewing, and then re-synchronized with the other perspective at a later time by the controller 62 controlling the play back means 58,60 to fast forward, rewind, play or stop as necessary to re-synchronize the first and the second recording media 14,16.

Figure 4(a) is a block diagram of an inventive automatic edit event recording system. In accordance with this aspect of the invention, event-recording means (camera recording system 64) records an event on a recording medium, such as a VHS, beta, or 8 mm video tape (or any other recording medium described herein). Selecting means (manual control buttons 66) is provided for selecting at least one edit-record interval corresponding to a respective selected portion of the recorded event. Signal generating means (edit signal generator 68) generates a start-record signal dependent on each selected edit-record interval. Signal recording means records each start-record signal on the recording medium. In accordance with the invention, the audio and/or video recording system of the camera (camera recording system 64) can be used to record the start-record signal onto a videotape or other recording medium. As an example, the edit signal generator 68 may generate an audio signal that contains separate start-record information for each edit-record interval. The audio signal should be above or below the range of human hearing so as not to interfere with the eventual viewing of the recorded event. The audio signal generated by the edit signal generator 68 can be sent to the camera recording system 64 to be stored on the videotape as the event is being recorded simultaneously on the same videotape by the camera recording system 64. Counter values can also be stored to determine the portions of the recorded tape that are to be later

reproduced on an edit version tape. The recording of the start-record and stop-record signals produces an auto-edit signal encoded master tape from which an edit version tape can be easily made. This master tape can also be used to control a VCR so that the edited version of the event can be viewed directly from the master tape. In this case, the VCR that is playing back the master tape is controlled in accordance with the start-record and stop record signals so that the information that is viewed from the master tape corresponds the edited version of the event intended by the camcorder operator. For example, the master tape can be play-fast forwarded until the start-recording signal is detected, and then played until the stop-recording signal is detected, etc.

Figure 4(b) is a block diagram of an inventive automatic edit play back and edited-recording system used to perform a subsequent edit-recording operation. The event recording means (i.e., camera play/fast-forward/rewind/pause system 70) performs a play back operation to play back a video/audio signal of the recorded event containing the start-record signal that is reproduced along with the play back of the recorded event. Signal detecting means 72 detects during the subsequent edit-recording operation each start-record signal from the recording medium (videotape 52). An edit controller 62 (which may be a part of or include the controller 62) controls the event-recording means (camera play/fast-forward/rewind/pause system 70) and an edited-recording means (VCR 50) during the edit-recording operation so that a play-back operation to play-back the event from the recording medium (videotape 52) is performed by the event-recording means (camera play/fast-forward/rewind/pause system 70), and a record operation to record an edited version of the event is performed by the edited-recording means (VCR 50). The edit controller 62 effectively controls the record operation during the subsequent edit-recording operation dependent on each of the detected start-record signals to record a copy of the recorded event having each said selected edit-record interval. To speed-up the time required to make the edited version, the controlling means may also includes means for controlling the event recording means (camera play/fast-forward/rewind/pause system 70) to fast forward the recording medium (videotape 52) through periods of the recorded event that are not the selected edit-record intervals (i.e., the uninteresting superfluous portions of the recorded event). The edit controller 62 controls the VCR 50 through a remote signal generator 74 that generates signals receptive by a remote signal detector 76 of the VCR 50. Since different VCRs respond to different remote signals, the remote signal generator 74 should be capable of producing different remote control signals (similar to a universal remote control).

Stated otherwise, during the recording of an event, a user of a video camera operates manual control buttons 66 to flag selected portions of the recorded event that are of interest and that should be included in a final edited version. Thus, the recorded videotape 52 contains the flagged interesting portions as well as the superfluous portions of the recorded event. During a subsequent edit-recording operation, the recorded video is played back by a play back device. The record/pause system 78 of a VCR 50 and the play/fast-forward/rewind/pause system of the play back device are controlled, so that only the flagged interesting portions of

the recorded event are re-recorded onto the edited version, with the superfluous portions being automatically edited out.

Figure 4(c) is a block diagram of an inventive automatic edit event recording system having a manual control button for selecting a beginning time of an edit-record interval. In accordance with this construction of the invention, the selecting means (manual control buttons 66) includes means for selecting a beginning time ("back-up time" button 80) of the edit-record interval. The beginning time occurs at a time prior to a time that the edit-record interval is selected (i.e., prior to depressing the "start flag" button 82). The signal generating means includes means for generating beginning time data along with the start-record signal. During a subsequent edit-recording operation, the camera play/fast-forward/rewind/pause system 70 (or other play back device) is controlled for rewinding the recorded videotape to the beginning time of the edit-record interval dependent on the start-record signal with the included beginning time data. In accordance with this feature of the invention, a user can include in a final edited version of an event, a portion of the recorded event that occurred prior to pressing the "start flag" button 82.

For example, if a user is recording a fishing expedition using a camcorder, there is no way to predict exactly when a fish will strike. To avoid including on the edited version of the event the boring superfluous wait for the fish strike, the user will not depress the "start flag" button 82 until after the fish has struck. In this case, the fish strike is not flagged for recording onto the edited version. However, by depressing the "back-up time" button 80, the start-record signal recorded on the recording medium at the time of depressing the "start flag" button 82 includes the beginning time. The amount of back-up time can be controlled to include an appropriate portion of the recorded event occurring before depressing the "start flag" button 82 so that the entire desired portion (i.e., the strike of the fish and the fight of the fish) can be automatically included in the final edited version of the recorded event. For example, depressing the "back-up time" button 80 once may include a 30 second beginning time data with the start-record signal so that the tape containing the entire recorded event is rewound 30 seconds. Each subsequent depressing of the "back-up time" button 80 may add an addition time, such as increments of 30 seconds to the amount of time that the tape is rewound. To simplify the operation, a single button can be used for both the "start flag" and the "back-up time", in which case, the back-up time is included starting with the second depressing of a "start flag/back-up time" button. An "end flag" button 84 is depressed after the desired portion of the recorded event has been recorded.

Figure 4(d) is a graphic illustration showing an example of a time relationship of an inventive automatic editing operation with manual beginning time selection. Figure 4(e) is a flow diagram of an automatic edit event recording operation and Figure 4(f) is a flow diagram of an automatic edit play back and edited-recording operation in accordance with the time relationships shown in Figure 4(d). Referring to Figures 8(d) and 8(e), an entire event is recorded starting with a start recording operation. An interesting event may occur at minute 1.5. However, the user does not depress the "start flag" button 82 to record flag 1 (start-record signal) until minute 2. To include the beginning of the interesting event, the user depresses the

"back-up time" button 80 once, and a 30 second beginning time data is included in the start-record signal of flag 1. The interesting event ends at the start of minute 5, so the user depresses the "end flag" button 84 to record the end on the selected portion of the recorded event. From minutes 5-8 the event is boring and contains superfluous uninteresting occurrences. Then, another interesting event happens at the start of minute 9, but the user does not appreciate the interest until minute 10. To include the beginning of this interesting event, the user depresses the "back-up time" button 80 twice, and a 60 second beginning time data is included in the start-record signal of flag 2.

Figures 8(d) and 8(f) show the operation to obtain an edited tape containing the interesting portions of the recorded event with the boring superfluous portions edited out. The camera (or other play-back device) plays the tape containing the recorded event, and a VCR 50 (or other recording device) is set to pause. The tape is fast forwarded (or played) until flag 1 is detected and read. The start-record signal of flag 1 includes the 30 second beginning time data, so the tape is rewound 30 seconds to the beginning of the first interesting event. The tape is then played and a video signal is generated by the play back device, while the VCR 50 records the first interesting event onto the edited tape. After the end of flag 1 is detected, the VCR 50 is set to pause. The tape is then fast forwarded to flag 2, which is detected and read. The start-record signal of flag 2 includes the 60 second beginning time data, so the tape is rewound 60 seconds to the beginning of the second interesting event. The tape is then played and a video signal is generated by the play back device, while the VCR 50 records the second interesting event onto the edited tape. Using this procedure, an edited tape is obtained containing only the interesting portion of the recorded event, while the superfluous boring portions of the recorded event are automatically edited out.

Figure 4(g) is a graphic illustration showing another example of a time relationship of an inventive automatic editing operation with manual beginning time selection. Figure 4(h) is a flow diagram of an automatic edit event recording operation and Figure 4(i) is a flow diagram of an automatic edit play back and edited-recording operation in accordance with the time relationships shown in Figure 4(g). Referring to Figures 8(g) and 8(h), an entire event is recorded starting with a start recording operation. As with the preceding example, an interesting event may occur at minute 1.5. Again, the user does not depress the "start flag" button 82 to record sflag 1 (start-record signal) until minute 2.

In this case, the start-record signal is a brief inaudible tone generated by a tone signal generator, such as the one described herein. To include the beginning of the interesting event, the user depresses the "back-up time" button 80 once, and a 30 second beginning time data (bflag 1) is included with the start-record signal of sflag 1. The bflag 1 may be, for example, another tone signal (of a different frequency or pulse) that is generated by the tone signal generator and recorded just after sflag1. The interesting event ends at the start of minute 5, so the user depresses the "end flag" button 84 to record eflag 1 along with the end of the selected portion of the recorded event. In this example, from minutes 5-6 the event is boring and contains superfluous uninteresting occurrences. Then, at minute 6 an interesting thing occurs and the user depresses the "start-flag" button 82 again to record sflag 2 (start-record signal).

This time, the user does not wish to include any previous portion of the event, and so there is no back-up time data generated. This interesting event continues until minute 8, at which time the user depresses the "end flag" button 84 to record eflag 2 along with the end of the second selected portion of the event. Then, another interesting event happens at the start of minute 9, but the user does not appreciate the interest until minute 10. To include the beginning of this interesting event, the user depresses the "back-up time" button 80 twice, and a bflag 3 tone is recorded (either a single that indicates 60 seconds or two tones that indicate 30 seconds each) so that a 60 second beginning time data is include along with the start-record signal of sflag 2. Similar steps are taken throughout the recording of the event so that a master tape is obtained having all or most of the event recorded on it, and having automatic editing cues, in the form of the sflags, eflags and bflags.

Figures 8(g) and 8(i) show the operation to obtain an edited tape containing the interesting portions of the recorded event with the boring superfluous portions edited out. In accordance with this aspect of the invention, professional looking scene transition are automatically incorporated into the edited tape version. The camera (or other play-back device) plays the master or originally recorded tape containing the full recorded event, and a VCR 50 (or other recording device) is set to pause ready to begin recording the automatically edited version of the recorded event. The master tape is fast forwarded (or played) until sflag 1 is detected and read. The start-record signal of sflag 1 (in-audible tone) is followed by bflag 1 indicating 30 second beginning time data, so the tape is rewound 30 seconds to the beginning of the first interesting event. The master tape is than played and a video signal is generated by the play back device, the VCR 50 is controlled to record the first interesting event onto the edited tape. After the eflag 1 is detected (inaudible tone indicating the end of the first interesting portion), the VCR 50 is again set to pause.

However, in order to include a professional-looking transition between the selected interesting events, the master tape is rewound just enough so that a transition portion of the first interesting event can be stored. The transition portions are the very end of a first scene and the very beginning of a second scene, and the professional-looking transition is obtained by manipulation the recording of the transition portions onto the edited tape. For example, the transition from the first interesting event to the second interesting event may involve a "dissolve" from the very end of the first interesting event to the very beginning of the second interesting event. Many other interesting transition effects can be incorporated between scenes (selected interesting portions).

In accordance with this aspect of the invention, the transition portions of the selected interesting events can be converted (if necessary) into digital information, and then digitally stored using, for example, a RAM, or other digital information storage method. The conversion of an analog portion of the recorded event into a digital data stream may be accomplished using, for example, using a Macintosh compatible computer that has the MOTION DC20 hardware and software installed. Macintosh computers and Macintosh system software are manufactured by Apple Computer of Copertino, CA and the miro Motion DC20 is manufactured by miro Computer Products AG, Braunschweig, Germany. This digital

information can then be manipulated using, for example, software such as Adobe Premiere, from Adobe Systems Incorporated, Mountain View, CA. Adobe Premiere allows for a number of different professional-looking various scene transitions including dissolves, wipes, checker board, barn door, etc.

After the transition portion of interesting event 1 has been stored, master tape is play fast forwarded until the next tone (sflag 2) is detected. In this example, there is no back up data recorded along with sflag 2. To produce the professional-looking transition between the first interesting event and the second interesting event, the transition portion of the recorded second interesting event must be stored. Thus, the very beginning of the second interesting event is converted into a digital data stream (if necessary) and combine using, for example, Adobe Premiere, with the stored first transition portion. The type of scene transition (dissolve, wipe, barn door, etc.) that occurs may be selected by the user or randomly generated. Once the scene transition has been generated, it is converted into an analog signal (if necessary). The VCR 50 is controlled to record and the scene transition is outputted and recorded. The rest of the second interesting event is played back from the master tape and recorded on the VCR 50. Recording of the second interesting event continues until a eflag 2 is detected. The master tape is rewound just enough so that the transition portion of the second interesting event (the very ending) can be stored. The master tape is then fast forward played until sflag 3 is detected. bflag 3 is also present just after sflag 3, and includes the 60 second beginning time data, so the master tape is rewound 60 seconds to the beginning of the second interesting event.

To produce the professional-looking transition between the second interesting event and the third interesting event, the transition portion of the recorded third interesting event must be stored. Thus, the very beginning of the third interesting event is converted into a digital data stream (if necessary) and combine using, for example, Adobe Premiere, with the stored second transition portion. Again, the type of scene transition (dissolve, wipe, barn door, etc.) that occurs may be selected by the user or randomly generated. Once the scene transition has been generated, it is converted into an analog signal (if necessary). The VCR 50 is controlled to record and the scene transition is outputted and recorded. The rest of the third interesting event is played back from the master tape and recorded on the VCR 50. Recording of the second interesting event continues until the end of the master tape or another flag is detected.

Using this procedure, an edited tape is obtained containing only the interesting portion of the recorded event, while the superfluous boring portions of the recorded event are automatically edited out. Also, in accordance with the present invention(s), the edited tape has automatically generated professional-looking transitions occurring between the selected interesting portions.

Figure 4(j) is a flow chart illustrating the operation of recording an edited version from an auto-edit signal encoded master tape. The master tape is placed in a first cassette player (which can be the camcorder, a VCR, or the inventive multi-featured multi-media appliance 1000 described herein). The blank edit version tape is place in a second cassette player (which, again, can be the camcorder, a VCR, or the inventive multi-featured multi-media appliance

1000 described herein). The start of the master tape is played (step one), and play continues (step two) until a start flag is detected (step three). If a start-flag is detected (step three), then it is determined if back-up data is detected (step four). If back-up data is detected (step five) then the master tape is rewound in accordance with the back-up data (step five). The information on the master tape is then recorded onto the edit version tape (step six). The recording continues until an end flag is detected (step seven), or the end of the master tape is detected (step eight). If the end flag is detected (step seven), then the recording of the edit version tape is paused (step nine) and control goes to step two. If the end of the master tape is detected, then the recording of the edit version tape stops (step ten).

Figure 4(k) is a flow chart illustrating the operation of recording an analog edited version from an analog auto-edit signal encoded master tape wherein a digital recording medium is used to temporally store the edited version tape. This algorithm illustrates how an inventive multi-featured multi-media appliance 1000 that include, for example, a computer hard drive, can be used with an existing VCR to produce an edited version tape from a master tape. Alternatively, the multi-featured multi-media appliance 1000 can include a computer hard drive and a video cassette tape drive. In accordance with this aspect of the invention, the master tape is placed in a first cassette player (which can be the camcorder, a VCR, or the inventive multi-featured multi-media appliance 1000 described herein). The start of the master tape is played (step one), and play continues (step two) until a start flag is detected (step three). If a start-flag is detected (step three), then it is determined if back-up data is detected (step four). If back-up data is detected (step five) then the master tape is rewound in accordance with the back-up data (step five). The information on the master tape is then converted from analog video data to digital video data (step six) and recorded onto the digital recording medium (step seven). The recording continues until an end flag is detected (step eight), or the end of the master tape is detected (step nine). If the end flag is detected (step eight), then the analog to digital conversion is paused (step ten) and the digital recording is paused (step eleven) and control goes to step two. If the end of the master tape is detected, then the digital recording stops (step twelve). Once the edited version of the event has been digitally recorded, the master tape is removed from the cassette, and the blank edit version tape is placed in the cassette (which, again, can be the camcorder, a VCR, or the inventive multi-featured multi-media appliance 1000 described herein) (step thirteen). Alternatively, if it is not desired to keep the original master tape with the superfluous recorded portions, then the master tape can simply be rewound and recorded over (step thirteen). The playback of the digital version of the edited version of the event begins (step fourteen) and continues (step fifteen). The playback of the digital version includes converting the digital video data to analog video data (step sixteen) so that it can be recorded on the blank edit version tape (step seventeen). The playback and recording continues until the end of the recorded digital video data is reached (step eighteen), after which the VCR recording of the edited version stops (step nineteen). By this algorithm, only one VCR deck is needed to perform the auto-editing features of the present invention(s).



As shown in Figure 5, the various inventive features described herein can be incorporated within a multi-featured multi-media convergence appliance 1000. Such a device may include the components necessary to enable one or more of the inventive aspects described above. For example, recording means and other components shown, for example, in Figure 1(a) can be included to enable the time-shifting operations described herein. The inventive multi-featured multi-media convergence appliance 1000 can include a modem 47 for receiving and sending data to a computer network such as the Internet to perform the Internet and network operations described herein. The receiving means 12 and a camcorder can include jacks 51 to exchange the audio and video signals to/from the camcorder or other video playback device to perform the auto-editing playback functions described herein. The inventive multi-featured multi-media convergence appliance Some or all of the auto-edit circuitry 49 can be incorporated onboard the camcorder, or some or all of the auto-edit circuitry 49 can be incorporated in the inventive Multi-featured multi-media convergence appliance 1000 (this is represented by the dashed line connecting the controlling means 24 with the auto-edit circuitry 49. For example, the determining means 23 (start-recording value detecting means 27 and stop recording value detecting means 29) can be utilized to detect the auto-edit signals. The controlling means 24 is responsive to the determining means 23 to control the rewinding/pausing/playback/fastforward operations of the source video tape and control the record/pause operations of the edited version video tape. The source video tape can be encoded with information that determines the edited version of the recorded event. The information can be a counter value, audio signal, video signal, or other identifying information that is used to trigger the appropriate control operations of the controlling means 24. The source video tape can be played back from one of the recording means, a VCR or the camcorder, and the edited tape can be recorded using one of the recording mediums, a VCR or the camcorder. The control of the VCR or the camcorder can be done through remote control signals generated by the remote signal generator 74, or through a direct connection with the inventive Multi-featured multi-media convergence appliance 1000.

Video cassette recorders (VCRs) are well known. Prior to the VCR, television viewers were forced to watch television programs in a synchronous manner, that is, in order to watch a television show a viewer had to synchronize his or her schedule to the time that the show was broadcast. Every viewer of a particular broadcast television show watched the show at the exact same time as every other viewer.

With the advent of the VCR, viewers are free to watch a broadcast television show asynchronously. That is, the viewer can set their VCR to record a show, and only *after* the entire show has been recorded can playback the show with viewer determined pauses and replays.

In accordance with the present invention, a multi-featured multi-media appliance 1000 is provided that overcomes the drawbacks of the conventional art. The multi-featured multi-media appliance 1000 can be configured to allow viewer determined pauses and replays at any time during the broadcast of a television show, and the viewer is able to watch the entire show. With the inventive multi-featured multi-media appliance 1000, a viewer can pause the display

of, for example a television program, at any time and for any length of time (limited by the recording capacity of the recording media). The pause can take place while the program is being aired, and the viewer can return to viewing the program from the point where the pause began, even while the program continues to be received. During the pause the viewer may replay a previously recorded portion of the program, fast forward through a recorded portion, or simply take a break from viewing and switch to another channel. Also, the present invention allows a viewer to pause the display of a program and switch to another media system, such as an Internet connection. The viewer can access information from the Internet computer network while pausing the display of a television program. Once the viewer has reviewed the computer network site, he can return to the television program without missing any of it.

In accordance with the present invention, a time sequential signal is received by receiving means 12, such as an antenna, cable television set top box, modem, etc. The time sequential signal contains an information stream, such as a television program, Internet or InterCast web pages, and/or a radio program. The information is displayed on displaying means 44, for example, on a television or computer monitor.

In accordance with the present invention a viewer can take an arbitrary pause during the viewing of the information. The information can be, for example, a broadcast television program displayed on a television set, or blanking interval information such as an InterCast web page or Internet hyperlink included in a broadcast (or multicast) program signal, or a radio program, or other information stream. The viewer inputs a pause display command using, for example, a remote controller that sends a radio or infrared signal to input receiving means 32. When the pause display command is received, recording means 14 is used to record a beginning of a first recorded portion of the time sequential signal on a first recording medium 16. The part of the time sequential signal that is received during the pause is recorded on the first recording medium 16 for the duration of the viewer-determined pause.

When the viewer desires to continue watching the television program, the remote controller is used to send a resume display command, which is received by the input receiving means 32. When the resume display command is received, the ending of the first recorded portion of the time sequential signal is recorded on the first recording medium 16.

In order for the viewer to watch the portion of the program that was received during the pause, the beginning of the first recorded portion is first determined, and the first recorded portion of the time sequential signal is then played back.

To enable the viewer to watch all of the program, that part of the time sequential signal that is received while the first recorded portion is being played back must also be recorded.

Thus, in accordance with the present invention, a second recorded portion of a different part of the time sequential signal is recorded on a second recording medium 22. The second recorded portion is a different part of the time sequential signal than the first recorded portion of the time sequential signal, since it contains the segment of the program that is received while the first recorded segment of the program is being played back. Of course, the first recorded portion contains the segment of the program that was received when the viewer took the pause. Thus, in accordance with the present invention, the playing back of the first

recorded portion of the time sequential signal and the recording of the second recorded portion take place.

It is determined if the ending of the first recorded portion has been played back. If the ending of the first recorded portion has not been played back, then playing back of the first recorded portion of the time sequential signal continues while simultaneously recording the second recorded portion of the time sequential signal. If the ending of the first recorded portion has been played back, then an ending of the second recorded portion of the time sequential signal is recorded on the second recording medium, the beginning of the second recorded portion is determined, and then the second recorded portion of the time sequential signal is played back.

In accordance with the present invention, what is played back (the first recorded portion) and what is recorded (the second recorded portion) are not the same, in the case of a television program, they are different segments of the program. The above-described recording and playing back scheme provides a method and apparatus that allows a user to arbitrarily pause the received program, or other information stream, and still view the program in its entirety.

The beginning of the first recorded portion is determined by setting a first start-recording value when the pause display command is received. This start-recording value is later used to determine where to start the playback of the recorded portion. When the pause display command is received, the determining means 23 makes an indication of the physical or electronic location of the beginning of the recorded portion. This indication (start-recording value) is used for finding where each recorded portion begins. The physical location of the beginning of each recorded portion may be, for example, a segment of a recording tape, or a sector and/or track of a recording disk, etc. The electronic location may be an address of a memory circuit, etc. The mechanism employed to set the start-recording value depends on the type of recording medium that is used. For example, if the recording medium is a magnetic tape, such as a VCR cassette, then the start-recording value can be set by generating and recording a tone signal. If the recording medium is a computer diskette or hard drive, then the start-recording value can be set by storing a disk location value in a file allocation table. A digital counter can be used to set the start-recording value by noting and storing the counter value when recording the beginning of the first recorded portion of the time sequential signal. A memory address can also be stored to set the start recording value if the recording medium is an electronic memory device such as a RAM. As another alternative, the physical location of the beginning of the first recorded portion can be predetermined. These same techniques can be employed for setting second and subsequent start-recording values, as well as for setting stop-recording values. In accordance with the present invention, the determining means 23 may include stop-recording value setting means 31 for setting a stop recording value. The stop-recording value indicates where the end of each recorded portion of the time sequential signal is located on the recording medium. The stop-recording value is used to determine the end of a recorded portion of the time sequential signal.

As the viewer watches the first recorded portion of the program played back from the first recording medium 16, the second recorded portion is recorded on the second recording medium 22. If the ending of the first recorded portion has not been played back, then playing back of the first recorded portion of the time sequential signal continues while the second recorded portion of the time sequential signal is recorded. The ending of the first recorded portion is determined by detecting the stop-recording value, which, as discussed above, may be a tone signal, a counter value, a physical location (such as a location on a disk stored in a file allocation table), etc.

When the ending of the first recorded portion has been played back (as determined by detecting the first set stop-recording value), then an ending of the second recorded portion of the time sequential signal is recorded on the second recording medium, and a second stop-recording value is set. The beginning of the second recorded portion is then determined using the second start-recording value, and then playback of the second recorded portion of the time sequential signal begins. Thus, the second recorded portion of the time sequential signal contains that part of the program that is received while the first recorded portion is being played back and playing back the second recorded portion enables the viewer to view the entire program without missing any of it.

Further, if the viewer wishes to re-watch a segment of the program then a viewer selected function (for example, rewind) is transmitted from the remote control to the input receiving means 32. After rewinding the recording medium (in the case of a VCR tape) or going to a previously viewed disk location (in the case of a hard drive, DVD, or other disk media) another viewer selected function (for example, play) can be transmitted. The segment that is rewound can then be watched again. Further, the viewer can fast forward through boring portions, or through commercials, and may be able to "catch up" with the reception of the time sequential signal so that the program can be again viewed as it is received. The viewer may also pause the viewing of the recorded portion of the program. In any event, as the viewer selected function(s) is performed, the time sequential signal still continues to be recorded as it is received so that the entire program can be watched at the viewer's leisure.

In accordance with the present invention, a time sequential signal is received via, for example, an antenna, a cable television hook up, Internet modem connection, satellite transmission or other information transfer mechanism. The information depending on the time sequential signal is displayed for viewing on a television, computer monitor, radio, or other displaying device 44. The information that is displayed may be a television or radio program, or received data from a computer network, such as the Internet. The present invention enables asynchronous viewing of a multicasted or broadcasted television program in conjunction with the perusal at the viewer's leisure of computer network information, such as a world wide web page downloaded from the Internet. The present invention allows a viewer to pause the display of a program and switch to another media system, such as an Internet connection. The viewer can access information from the Internet computer network while pausing the display of a television program.

The time sequential signal may be a television program which contains a blanking interval (a portion of the video signal that is received during a time when the video display scanning returns to the top of the screen). The blanking interval can include blanking interval information including a selectable link, such as a network address, to network information, such as a world wide web page, from a computer network, such as the Internet. The television program is displayed before receiving the pause display command. When the viewer wishes to obtain information via the Internet, the viewing of the television program is paused and the computer network is accessed using a modem or other suitable accessing means. The network information that is addressed by the selectable link is received from the computer network. This network information is displayed while the viewing of the television program is paused and time sequential signal is recorded so that the program viewing can be returned to at a later time without missing any of the program.

The inventive multi-featured multi-media appliance 1000 can display a received television commercial 144 having an Internet address automatically linked by a hypertext message 146. Viewing of the paused program can continue in the time shifted manner described herein after the viewer returns from the Internet session.

Program information can be retrieved from the Internet, the television signal, or other medium, and displayed for the user during the operation of the inventive multi-featured multi-media appliance 1000. The program information can be searched to select specific shows that are of interest to the user and then program information for the selected shows can be downloaded or otherwise retrieved to enable the inventive multi-featured multi-media appliance 1000 to provide easy VCR or video recording capabilities.

The inventive multi-featured multi-media appliance 1000 can be configured to selectively restrict the reception of television and data content that a parent or care-giver decides is inappropriate for viewing by children. The content available to the user can be rated in accordance with a collaborative consensus of the user's of the computer network and/or television system.

The inventive Internet/television convergence appliance can be used to program a VCR via downloaded VCR control information received from an Internet source, a disk or tape mailed to the user or through the television signal. The downloaded VCR control information can be used to control recording on one or more of the recording mediums incorporated in the inventive multi-featured multi-media appliance 1000. The inventive Internet/television convergence appliance 1000 can incorporate components 53 such as a television tuner, computer hard drive, video card and/or frame grabber and printer port. Other peripheral components can also be included to enhance the usefulness of the inventive Internet/television convergence appliance. For example, the peripheral components may include a speaker phone, answering machine, radio tuner or remote home wiring control circuitry.

Figures 6(a) through 6(b) show the configuration of the first and second recording medium 16 and 22 of the inventive time shifting event recorder shown, for example, in Figure 1(a). In this case, the first recording medium 16 comprises at least one portion of a recordable disk and the second recording medium 22 comprises at least one other portion of

the same recordable disk. Read/write heads of the respective recording means is able to retrieve and write information on different portions of the same recordable disk simultaneously. Thus, a single recordable disk is used as the recording medium for both the first and second recording medium 20. As shown in Figure 6(a), the recordable disk is recorded on one side thereof by both read/write heads 38 of the respective recording means. Figure 6(b), on the other hand, shows a configuration in which the disk recording medium is recorded on both sides thereof. In this case, the read/write head 38 of one of the recording means records on one side while the read/write head 38 of another of the recording means records on the other. It is noted that if a third or more recording means is utilized, then another read/write head 38 may be used to record and play back information from different portions of the disk recording means. In the case of the memory circuit, the idea is the same. Namely, each recording means records the respective portions of the time sequential signal at, for example, different address locations of the memory circuit and these locations are addressed to retrieve the stored information. The disks can be stacked, or otherwise configured to increase the storage capacity. Nearly any configuration suitable for recording video signals can be used, so long as the recording and playback of information can occur simultaneously. Buffers can be used so that, for example, the video data can be compressed and expanded as necessary.

Figure 7(a) shows a block diagram of a configuration of the inventive time shifting event recorder wherein an electronic storage medium is constructed on a video card for easy assembly into media appliances and devices. In this case, an electronic storage medium 11, such as a DRAM configuration, enables the inventive time shifting event recorder to be constructed as, for example, an expansion card 13 that can be incorporated into an existing device. For example, a DRAM configuration for the video storage mediums described herein can be incorporated on a PCI or similar card along with the necessary ancillary microprocessor(s) 15 and other electronic components to enable the time shifted recording capabilities described herein. The microprocessor 15 and other components may be part of the device to which the time shifted recording expansion card is being incorporated in, or some or all of these electronic components can be included with the expansion card 13.

It is likely that up and coming multimedia devices, such as Internet appliances, set top boxes, so-called network computers, high definition televisions, computers, VCRs, DVD drives, etc. will include provisions for expanding the devices capabilities either during the initial product configuration by the distributor or through upgrades that can be incorporated after the consumer has purchased the device. The electronic memory (i.e., DRAM and the like) provides a convenient vehicle to enable such devices to be configured or retrofitted with the many advantages of the inventive time shifting event recorder. If the historic trends continue, it is very likely that the capacity and speed of such electronic memory components will increase, while their costs decrease, making this implementation of the inventive time shifting event recorder even more compelling to the consumers of multimedia and like devices.

The following is an illustration of a specific embodiment of the inventive time shifting event recorder. It is noted that this embodiment illustrates only one of many configurations for the inventions, as described herein. Figure 7(b) shows a block diagram of a configuration of the inventive time shifting event recorder for arbitrarily pausing the display of a video signal, such as a television program. The system components of this configuration includes a microprocessor 110 and electronic circuitry that controls the operation of a first VCR (VCR1 112), a second VCR (VCR2 114), a video signal switch 116, and a data storage device 118. An Internet appliance 120, along the lines of WebTV, may be provided to enable access to the Internet and on-line services during the user-determined pauses made possible by the inventive time shifting event recorder. Access to the Internet and on-line services is accomplished via modem or other data transfer devices. Also, a universal-type remote control signal generator and/or receiver 122 may be included to send control signals to the components and to receive user input in the form of wireless remote control signal. Further, depending on the configuration of the inventive system, the data can be transferred between the microprocessor 110 and the other components using a high speed transfer system such as that specified as IEEE 1394 also known as "FireWire". The video information and Internet data is displayed on a television 124.

The first and second VCR drives (VCR1, VCR2 112,114) may be separate video cassette recorder units, or may be combined in a single dual-deck video cassette recorder. The microprocessor 110 may include some of the peripheral devices such as the data storage device 118, and additional electronic components may be required to implement the control of the inventive time shifting event recorder in the manner described herein.

The control of the VCRs 112,114, video signal switch 116, television 124 and/or Internet appliance 120, and the reception of data from the devices may be accomplished by direct wiring. For example, the electronic circuit included in the VCR that drives the display showing the counter-value may be directly connected via wires to the microprocessor 110. Alternatively, remote control signals generated by the remote control signal generator and/or receiver 122 can be used to enable the microprocessor 110 to control the operation of the system components. Additional circuitry may be included to enable split screens or picture-in-a-picture display of, for example, user-determined instant replays, Internet content and the like. The television signal can be received through an antenna, co-axial cable, satellite dish or any other means for receiving TV signals (as illustrated by block "TV signal in" 126).

Figure 8 shows a flowchart of an algorithm showing the operational steps of the configuration of the inventive time shifting event recorder shown in Figure 7. This algorithm demonstrates a time shifting event recorder comprised of two conventional VCRs (VCR1 112 and VCR2 114) controlled by a microprocessor 110 circuit, however, as discussed at length herein other configurations are possible all falling within the scope of the invention. Before the time shifting operation, the tape counters of each of the VCRs 112,114 can be reset so the counter-value at the start of recording is 00:00:00. In addition to resetting the counter values, the video cassette of each VCR can be rewound to its beginning prior to resetting the tape

counters. Further, the stored value  $C(q)$ , the counter-value of the recording VCR when a quit command is received, is reset to a value of 0 (step 1).

In accordance with this configuration, at least one of the VCRs 112,114 (vcrR) is tuned to the selected channel SC and receives the television program as video-in (step 2). As will be described, the present invention enables the user to arbitrarily pause the reception of this television program at any time, and for any length of time, limited only by the recording capacity of the VCRs 112,114. As an optional step, both VCRs can be initially tuned to the same television channel on which is carried the television program that is being viewed by the user, then one of the VCRs (not vcrR) can begin recording at the onset of the program so that even portions of the program that are viewed before the user-determined pause can be replayed.

The television signal is received through the VCR1 112 (vcrR) as video-in (step two) and the video signal switch 116 is controlled by the microprocessor 110 so that the program is displayed on the television 124 in real time (step three). The microprocessor 110 waits for a pause command to be inputted by the user (step four). As long as the pause command is not received (N; step four), the video-in is displayed (step three) so that the television program continues to be displayed as it is received (real-time). If the user wishes to view a user-determined instant replay, or engage in an Internet session, or channel surf, or simply take a viewing break, then a pause command is inputted (via a remote controller) and the microprocessor 110 controls the video signal switch 116 and the VCRs 112,114 and/or Internet appliance 120 in accordance with the viewing selection of the user.

For example, if the user wishes to begin an Internet session, the microprocessor 110 controls the Internet appliance 120 so that a connection with the Internet is made. During the time it takes for the connection to be made and the Internet session to begin, the program may continue to be viewed. For example, it can be detected when the home page of the Internet browser used by the Internet appliance 120 is loaded or is being loaded, and then the microprocessor can control the video signal switch 116 so that the signal from the Internet appliance is then displayed. The time shifting recording operations on vcrR can begin at the onset of the user's input to begin the Internet session so that the portion of the program that is received while the Internet connection is being made is available for later viewing. If the program continues to be viewed while the connection is being made, then counter-value  $C(s)$  (described below) can be determined when the video signal switch 116 switches from television program to the Internet session (to avoid redundant viewing of the program).

In any event, when the user inputs the pause command (Y; step four), then recording of the video-in begins on vcrR starting at the counter-value  $C(s)$  (step five) (unless modified as described in the preceding paragraph). The counter-value  $C(s)$  can be predetermined by resetting vcrR's counter to 0:00:00 (i.e., step one), or the current counter-value can be detected. The counter-value  $C(s)$  is sent to the microprocessor 110 via a wire link, or through an infrared or other remote data transmitter (if the counter-value 0:00:00 is used, the microprocessor 110 sends an appropriate signal to the vcrR so that the counter is reset) if it was not reset in step one. The counter-value  $C(s)$  is stored by the microprocessor 110 in the



counter-value storage device 118 so that the location of the beginning of this portion of the recorded video-in can later be determined. The microprocessor 110 controls vcrR to record the received television signal (video-in) during the user-determined pause. The control of the VCRs 112,114, video signal switch 116 and/or Internet appliance 120 can be done via wire links, or through an infrared or other remote data transmitter. For example, to increase the versatility of the invention, the control of the VCRs 112,114 can be accomplished using circuitry similar to a commercially available "universal" remote controller.

During the user-determined pause, the user can access the Internet via an Internet appliance 120 such as WebTV. The television signal that carries the program can also include hyper-links to related Internet content. For example, a TV commercial may include a hyperlink to the advertiser's Web site. At the user's option, the hyperlink can be activated resulting in the retrieval of information from the Internet. Once the connection is established and the desired Web site is ready for display, the "pausing" of the program occurs in the manner described herein.

Once the pause command is received by the microprocessor 110, the video signal switch 120 is controlled so that the display on the TV 124 is in accordance with the user's selection (step six). If recording begins at the start of the program on VCR2 114 (even though it is viewed in real-time), the user may also engage in user-determined instant replays by rewinding and replaying a portion of the recorded video-in that was received prior to the pause (step six). In this case, the microprocessor 110 controls the video signal switch 116 so that the output of the VCR2 114 containing the "instant replay" recording is displayed on the TV 124 while video-in is recorded on vcrR (VCR1 112). During the pause, the microprocessor 110 can control the video signal switch 116 so that the video signal from the Internet appliance 120 is displayed on the TV 124 (if the user chooses to access the Internet). The microprocessor 110 can control the video signal switch 116 so that the video signal from the VCR2 114 is displayed on the TV 124. In this case, the television program that is being recorded is tuned in by vcrR (VCR1 112) while the tuner of the other VCR (VCR2 114) can be used for channel surfing.

The recording of the video-in (television program) continues (step seven) while the microprocessor 110 waits for the user-inputted resume command (step eight) and controls the various devices (VCRs 112,114; Internet appliance 120; video signal switch 116, etc.) in accordance with the user's selections.

During the recording of the television program, the existence of television commercials can be detected by detecting the information that is included in the vertical blanking interval (VBI) of the television signal. Recording of the television commercials can be prevented by sending a record-pause signal from the microprocessor 110 to vcrR when the beginning of a commercial break is detected, and then sending a record-resume signal from the microprocessor 110 to the vcrR when the commercial break ends.

If the resume command is not inputted (N; step eight), then it is determined if a quit command has been inputted (step nine). As long as no resume command (step eight) or quit

command (step nine) is received, the video signal switch 116 is controlled to display the user's selection and recording of video-in on vcrR continues (step seven).

The quit command can be generated by a remote controller under the control of the user. Alternatively, the quit command (or other control command, such as to initiate and control an Internet session) can be generated in response to a information embedded in the television signal. For example, if the quit command is included in information embedded at the end of the television program, it can be detected and used (as described herein) by the microprocessor 110 to determine when to stop recording the television program.

If the quit command is received before the first resume command (Y; step nine), then the current counter-value of vcrR is stored as C(q) in the counter-value storage device 118 (step ten) and the microprocessor 110 controls vcrR to end recording video-in (step eleven). Once the resume command is inputted (Y; step twelve) the vcrR is controlled by the microprocessor 110 to rewind back to counter-value C(s) and begin playback of the recorded portion of the TV program as video-out (step thirteen). To save time, the rewind operation can begin as soon as the recording ends (step eleven). The VCRs 112,114, Internet appliance 120 and video signal switch 116 are controlled according to the user's selection so that the user's selection is displayed. For example, if the user's selection is to engage in an Internet session, then the playback from vcrR is paused and the video signal switch 116 is controlled so that the signal from the Internet appliance 120 is displayed.

Once the current counter-value of vcrR equals C(q) (step fifteen) the portion of the program recorded prior to the quit command has been played back and the time shifting recording operation ends (step sixteen).

When the resume command is received (Y; step eight), then the recording of video-in on vcrR ends at counter-value C(e) (step seventeen). Thus, the location of the cassette tape that contains the just-recorded portion of the TV program is defined by the end points determined by values C(s) and C(e). The counter-values C(s),C(e) can be obtained by taping into the wiring of the VCR that drives the display that shows the counter value. The value of C(e) is stored by the microprocessor 110 so that the location of the ending of the recorded video-in can later be determined. The resume command can be inputted automatically from an Internet site so that when the user has come to the end of related information contained on the Internet site a command is sent from the site to the user's Internet appliance 120 that in turn sends the resume command to the microprocessor 110.

Once the resume command is received, the microprocessor 110 controls the VCRs 112, 114 so that the recording VCR, (vcrR; now VCR1 112) becomes the playback VCR (vcrP) and the playback VCR (vcrP; now VCR2 114) becomes the recording VCR (vcrR) (step eighteen). Thus, in the first iteration of the loop vcrR changes from VCR1 112 to VCR2 114, and vcrP changes from VCR2 114 to VCR1 112.

The portion of the television signal that is received during the playback of the portion that was received during the pause is recorded so that it can be later viewed. If it is not already so tuned, vcrR is tuned to the selected channel SC to receive the television program (video-in) (step nineteen). In accordance with this embodiment of the invention, the microprocessor 110

re-stores the value of C(s) as C(p) and set C(s) to the counter-value at which recording begins on vcrR (now, VCR2 114) (step twenty).

In this case, the data storage device needs to have enough capacity to store at least the five counter-values, C(s), C(e), C(p), C(l) and C(q). The microprocessor 110 retrieves the value of C(p) (formerly, C(s)) and vcrP is rewound to counter-value C(s) (the beginning of the portion received during the pause). The microprocessor 110 sends control signals to vcrP to rewind the cassette until counter-value C(p) is detected (indicating the beginning of the just-recorded portion of the TV program). Then once counter-value C(p) is reached, vcrP is control to begin playing back the just recorded portion as video-out (step twenty-one(a)).

At the same time that vcrP is being controlled to rewind to counter-value C(p), vcrR (now, VCR2 114) is controlled to begin recording the video-in (television program) starting at counter-value C(s), and C(s) is stored by the microprocessor 110 (or the counter of VCR2 114 is reset to 0:00:00) (step twenty-one(b)). Alternatively, the VCR's counter can be reset to 00:00:00, and C(s) preset to equal 00:00:00.

After the first iteration of the loop, when recording video-in on vcrR the cassette of vcrR can be rewound, if necessary, so that the counter-value is again 00:00:00. However, during the time that the cassette is rewinding, the television program will not be recorded. Therefore, it may be preferable to either modify the cassette so that the time for rewinding is relatively short, or simply to forego the rewinding operation unless the end of the tape is reached. If the cassette is to be modified, the take-up and supply reels of the cassette can be constructed so that the supply reel is relatively larger than the take up reel. Thus, each revolution of the supply reel (when it is driven in reverse during the rewind process) will replace more tape back onto the supply reel than if both reels were of equal diameter.

The microprocessor 110 switches the video signal switch 116 so that the played back video-out is displayed (step twenty-two) on the TV 124 and the user views the portion of the television program that was received during the pause. While the video-out is played back from vcrP, the video-in continues to be recorded on vcrR. The microprocessor 110 waits for either the end of video-out (step twenty-three) or another user-inputted pause command (step twenty-five or step twenty-eight).

The end of video-out is determined by detecting when counter-value C(e) is reached on vcrP. Thus, the microprocessor 110 compares the current counter-value of vcrP with the stored value C(e). When the current counter-value equals the stored value C(e), then the end of video-out (for this recorded portion of the program) has been reached (Y; step twenty-three). If the end of video-out is not reached (N; step twenty-three), the microprocessor 110 determines if the stored value C(q) is equal to 0 (step twenty-four). In step one, C(q) is reset to 0, and it does not change from 0 unless the a quit command is received. Thus, if C(q) is equal to 0 (Y; step twenty-four), the quit command has not yet been received, and it is determined if a command has been inputted that equals the quit command (step twenty-five). If the quit command has been inputted (Y; step twenty-five) then the current counter-value of vcrR is stored as C(q) (step twenty-six) and the recording of video-in on vcrR ends (step twenty-

seven). Control then goes back to step twenty-two and the video-out continues to be displayed without the recording of video-in onto vcrR.

If the quit command is not inputted (N; step twenty-five), then it is determined if a pause command is inputted (step twenty-eight). If the pause command is not received (N; step twenty-eight), the display of video-out (recorded show portion) from vcrP and the recording of video-in (received show portion) onto vcrR continues.

The user may take any number of pauses during the time-shifted viewing of the television program. When the user inputs a pause command (Y; step twenty-eight), the playback of video-out from vcrP is paused and the current counter-value can be stored as C(l) by the microprocessor 110 (step twenty-nine). The counter-value C(l) is stored as a marker for the end of the played-back portion of the time-shifted television program so that play back can be picked up where it left off. During the pause, the last frame of video-out, the real time program or a blank screen can be displayed, or the user can access the Internet, watch a user-determined instant-replay or channel surf.

While the viewing pause is occurring, the video-in (received television program) continues to be recorded on vcrR and the user's selection is displayed (step thirty). The microprocessor 110 waits for an inputted resume command (step thirty-one). If the resume command is not received (N; step twenty), it is determined if the stored value C(q) is equal to 0. If C(q) is not equal to 0, then the quit command has already been entered. In this case, control goes immediately back to step thirty and the user's selection continues to be displayed.

Again, if C(q) is equal to 0, then the quit command has not yet been entered. In this case, it is determined if the quit command is inputted. If it not (N; step thirty-three), then the video signal switch 116 is controlled so the user's viewing selection is displayed on the TV 124 (step thirty) while the incoming television program is recorded on vcrR (step nineteen). If the quit command is inputted (Y; step thirty-three) then the current counter-value of vcrR is stored as C(q) (step thirty-four) and the recording of video-in on vcrR ends (step thirty-five). Control then goes back to step twenty-nine and the video-out continues to be displayed without the recording of video-in onto vcrR.

When the resume command is received (Y; step thirty-one), then the playback of the video-out begins again from vcrP starting at counter-value C(l) (step thirty-six). Thus, when the user wishes to begin viewing the program again (or at a time dictated by, for example, a response to a web page), a resume command is inputted. The stream of video information is retrieved from the vcrP starting at the last portion of the recorded video that was displayed (counter-value C(l)).

Control then goes to step twenty-two, and the video-out from vcrP is displayed until the current counter-value of vcrP is equal to the stored value C(e) indicating that the end of the recorded portion on vcrP is reached (step twenty-three), another pause command is received (step twenty-eight), or if it has not yet been received, the quit command is inputted (step twenty-five or step thirty-three).

When the end of video-out is reached (Y; step twenty-three), then it is determined if the stored value C(e) is equal to the stored value C(q). This will be affirmative when the portion of

the program that was recorded when the quit command was entered has been played back. If  $C(e)$  does not equal  $C(q)$ , then it is determined if the quit command has been inputted yet by checking if  $C(q)$  is equal to 0. If  $C(q)$  is still equal to 0, then the end of the time shifting operation has not yet been determined.

The quit command is inputted by the user when it is desired to end the time shifting operation and stop recording the video-in signal for later time shifted viewing. When the user inputs the quit command, the current counter value of vcrR is determined and stored as value  $C(q)$  in the data storage device 118. The recording on vcrR may continue so that the TV channel being recorded can be later viewed, or recording can stop all together.

If the quit command has not yet been received (Y; step thirty-eight), then control goes back to step seventeen, and the end of the video-in is recorded on vcrR (in this, the second iteration of the loop, the VCR2 114) at new counter-value  $C(e)$  which is stored in the data storage device 118, and the algorithm continues as described above. At the start of each iteration of this loop, the recording VCR (vcrR) becomes the playback VCR (vcrP) and vice-versa (step eighteen). Thus, the entire television program is available for time-shifted viewing.

Until the quit command is entered, the time shifting operation continues even after the initial television program has ended. The television programs that are on the same channel as the initial program can be watched in a time shifted manner. If the user wishes to watch another channel in a time shifted manner, then he inputs the quit command to end the time shifting of the current TV channel, switches to another channel, and then inputs the pause command to begin time shifted viewing of the new TV channel.

If the quit command has been entered, then  $C(q)$  does not equal 0 (N; step thirty-eight) and control goes to step thirty-nine where the recording VCR (vcrR) becomes the playback VCR (vcrP) and vice-versa (step thirty-nine). In order to end the time shifting operation, the stored value  $C(e)$  becomes equal to the stored value  $C(q)$  (step forty). Next, vcrP is then rewound until the stored value  $C(s)$  is reached on the VCR's tape counter, and then playback of video-out begins from vcrP. Playback continues until either the pause command is received (step twenty-eight) or the end of the last recorded portion of the program has been displayed (Y; step twenty-three). Since  $C(e)$  has been made equal to  $C(q)$  in step forty, then the values are compared again in step thirty-seven the time shifting operation will end (step forty-two). At the end of the time shifting operation, control can return to step one where the system is reset and made ready for the next time shifting operation.

A copy of the entire program can be obtained at a later time if: the program recording begins when the program begins; the recorded portions are not destroyed; and the counter-values that indicate at least one of the beginning and the ending of each recorded portion are stored.

To give the user the option of obtaining a complete recording of the program a third VCR can be employed to receive the recorded portions of the program in the correct sequence from each of the two VCRs used to effect the above-described time shifted viewing. If a copy of the entire program is desired, then one of the VCRs is controlled to record the program from the beginning of the program (i.e., before the first user-determined pause) and the

counter-values  $C(s)$  and  $C(e)$  for this recorded portion are stored. During the time shifted viewing operation each of the counter-values  $C(s)$  and  $C(e)$  are stored as well. During the time shifted viewing operation the VCRs are controlled so as to keep the recorded portions from being destroyed (that is, the recorded portions are not re-recorded over). Thus, after the initial recorded portions on each VCR, each recorded portion on each VCR begins after the end of the last recorded portion that had been played back.

After the program has been recorded on the two VCRs, the recorded segments are played back in the correct sequence as dictated by the stored counter-values  $C(s)$  and/or  $C(e)$ . This resulting video signal is fed to a third VCR on which the program is re-recorded in its entirety (or what ever portion of it is available from the two VCRs).

The specific configurations described herein illustrate only some of the possible constructions of the inventive time shifting recording device. For example, the VCRs just discussed with reference to Figures 7(b) and 8 can be substituted by other video recording/playback devices, such as DVD drives, computer hard drives, flash memory, eeprom, etc. In one practical construction, all the components except for one of the video storage devices is incorporated into a single unit. For example, an Internet appliance can include the microprocessor 110 (computer CPU) and a DVD-Ram drive (with the DVD-Ram possibly also functioning as a computer hard drive). An existing VCR (or other video storage device) can be used as the second video storage device. This configuration enables the unique attributes of the inventive time shifting recording device while reducing complexity and cost by utilizing the video recording/playback capabilities of an already existing VCR.

Figure 9 is a flowchart of an algorithm showing the operational steps of the configuration of the inventive time shifting event recorder. This operation of this flow chart is similar to that of the flowchart shown in Figure 7. However, this flowchart illustrates the general steps of the inventive time shifting recording method. In this case, the recording mediums can be any combination of recording devices that are suitable for recording video and playing back video information, including, but not limited to magnetic tape, magnetic disks, optical disks, electronic circuits, etc.

At the start of operation, the recording mediums (med1 and med2 are designated as medR and medP, respectively) (step one). The video signal is received as video-in (step two) and video-in is displayed (step three). As long as a pause command is not received (N; step four) video-in continues to be displayed. Once the pause command is received (Y; step four), a segment of video-in is recorded on medR starting at value  $R(s)$  (step five) and the pause begins. During the pause, the display shows the user's selection (step six) which as discussed herein might be an Internet web site, another television program, a prerecorded program (which may be included on the recording mediums med1 and/or med2 and/or on a third medium), etc. The recording of video-in on medR continues (step seven) until a resume command is received (Y; step 8).

Once the resume command is received, the end of video-in is recorded on medR ending at value  $R(e)$  (step nine), and medR becomes medP, and medP become medR (step ten). The recording of another segment of video-in begins on medR starting at value  $R(s)$  (step

eleven), and playback as video-out of the previously recorded segment from medP begins starting at R(s) (step twelve). Note: R(s) of medP is not the same as R(s) of medR. The video-out is displayed (step thirteen) and continues to be displayed (step fourteen) until either a pause command is received (step sixteen) or the end of the recorded segment is reached (step fifteen). If a pause command is received (Y; step sixteen) then the playback of video out is paused and, in an optional step, the value of where the playback is paused is saved as R(l) (step seventeen). The user's selection is displayed during the pause (step eighteen) and recording of video-in continues on medR (step nineteen). When the resume command is received (Y; step twenty) then playback of video-out continues from medP starting at R(l) (step twenty-one) and control goes back to step thirteen and video-out is displayed. When the end of playback of the recorded segment from medP is reached (Y; step fifteen), then it is determined if the end of the show has been reached or if the user has selected to end the time shifting operation (step twenty-two). If the time shifting operation is to continue (N; step twenty-two) then the program continues from step nine wherein the end of video-in on medR is recorded at value R(e) (step nine) and the playback medium (medP) becomes the recording medium (medR) and vice versa.

Using recently developed compression schemes, it is now possible to transmit a movie at substantially faster-than-real-time data transfer rates. For example, U.S. Pat. Nos. 4,963,995 and 5,057,932 to Lang describe a burst mode transmission of audio/video program information in a burst period of time that is substantially less than the time required for real time viewing of that audio/video program information. U.S. Pat. No. 5,440,334 to Lang describes how this burst mode transmission of audio/video program information can be used to provide a video distribution system that will allow subscribers to the system a choice between a number of video programs in a type of video-on-demand (VOD) system. However, as with the prior attempts at a VOD system, the subscriber must wait until the entire program has been transmitted to and recorded on the subscriber's VCR (or, presumably, other video recording device) before viewing of the selected program begins.

In accordance with the present invention, a VOD-type system is provided that enables a subscriber to begin viewing the selected program even while it continues to be received. Thus, the subscriber does not have to wait for the entire program to be received before viewing begins, making the present invention a substantial improvement over previous VOD-type systems.

Figure 10 is a flowchart showing the operation of the present invention for use in an enhanced pay-per-view (PPV) movie system. A subscriber receives pay-per-view (PPV) selection options (step one). Of course, the received programs do not necessarily have to be of the pay-per-view type, but can be any TV program or movie or other data stream. The subscriber selects a PPV movie and send a request to the system provider (step two). In this illustration, the movie data is transmitted in received as packets of data, either compressed (e.g., burst mode) or uncompressed. In the case of uncompressed transmission, the received PPV movie is viewed like a conventionally received television program, but with the time shifting features (user determined pauses, replays, etc.) described herein. In the case of compressed

data, the faster-than-real-time transmission capability allows for enhanced features as described below. The first packet of data of the first segment of the movie is received and recorded on diskR (step three). It is possible that the data packets will not be transmitted in chronological order. That is, the packets may be received by the subscriber as they become available on the system. Thus, the packets may include packet sequence information that is used to ensure that the recorded packets are replayed in the correct time sequence. In this case, the first packet sequence information may be stored, for example, in RAM, at a memory location designated S(s) (step three). The packets of the first segment of the movie continue to be received and recorded on diskR, while the packet sequence information for the received packets is stored (step four). As in the other embodiments and configurations described herein, it may be possible to substitute different recording mediums for the diskR and diskP (e.g., tape, electronic memory, etc.). As long as the first segment of the program is still being received (N; step five), the packets of the first segment of the movie continue to be received (step four). In this example, the first segment of the movie encompasses a length of viewing time that is appropriate in terms of the PPV system requirements and limitations. Specific timing examples are described below which illustrate this.

Once the first segment is received (Y; step five), the recording on diskR ends and the sequence information of the last packet (in terms of viewing time sequentially) is stored as S(e) so that the end of the first segment can be later determined (step six).

As with the other example flowcharts, diskR becomes diskP and vice-versa (step seven). To facilitate operation, the value of S(s) is given to variable S(p) (step eight). Playback of the recorded segment on diskP as video-out begins starting at sequence information S(p) (step nine), while the first packet of the next segment of the movie is received and stored on diskR and the first packet sequence information is stored as S(s). Video-out is displayed (step eleven) and the viewer watches the selected movie. The packets of the next segment of the movie continues to be received and recorded (step twelve) while playback of the recorded segment in accordance with the stored packet sequence information continues (step thirteen). The packets of the movie data do not necessarily have to be received in the correct chronological order, the sequence information is used to ensure that during playback the movie is viewed in the correct time sequence.

The end of the recorded segment that is being played back is determined by detecting when the current packet sequence being played back is S(e). If the end is not reached (N; step fourteen), then video-out continues to be displayed (step eleven); the received packets continue to be recorded on diskR (step twelve); and the playback of the recorded segment from diskP (step thirteen), continues.

Once the end of the recorded segment has been reached (Y; step fourteen), the control goes to step six and the selected PPV program continues to be viewed and recorded in the time shifted manner described herein.

This flowchart illustrates how the present invention can be used to allow a subscriber to begin viewing a selected program soon after it is selected from a PPV or VOD system. In conventional PPV and VOD systems that take advantage of burst mode or compressed data



transmissions, the entire program must first be received before it can be viewed. In systems that transmit the PPV or VOD selection in real time, the movie is viewed in the manner of a broadcast television program. The present invention, on the other hand, allows the viewer to begin viewing a compressed transmission movie well before the entire movie is received and recorded, and the enhance features of user-determined pauses, replays, etc. described herein are available with either compressed or real-time transmitted movies.

Figure 11(a) shows the timing of a movie selected from a VOD system that transmits the video data compressed 2:1. In this case, once the movie begins to be received, the viewer must wait fifteen minutes for the transmission of a movie with a viewing length of thirty minutes. Once the entire movie has been transmitted, the subscriber can begin viewing.

In contrast, Figure 11(b) shows the timing of a movie selected from a VOD-type system in accordance with the present invention. The compression rate and minutes shown are for illustrative purposes, the timing of an actual compressed movie will vary depending on factors such as compression rate, transmission error corrects, In this case, the first segment of the movie is transmitted (along with its sequence information if necessary) in the first minute of elapsed time and recorded on disk1. The first segment contains the first two minutes of the movie. Once the first segment is received, it is played back from disk1 beginning at minute 2 of the elapsed time. While the first segment is being played back from disk1, the next segment of the movie is received and recorded on disk2 during minutes 2 and 3 of the elapsed time. The inventive time shifting recording and playback operation continues in the manner described herein thereby allowing the viewer to view the entire program without having to wait for the entire program to be received. In this example, the viewer would have had to wait 15 minutes for the movie to be received (see, Figure 11(a)) before viewing could start. In accordance with the present invention, the viewer begins viewing the movie as soon as the first segment of it has been received. Of course, the viewing length of the first segment could be even shorter, making the time for it to be received (the time before viewing begins) less.

Figure 11(c) shows the timing of a movie selected from a VOD-type system as in Figure 11(b). In this case, the compression ration is 5:1, meaning that five minutes of movie viewing are transmitted each minute. In this case, the viewer receives the first five minutes of the movie in the first minute of transmission.

Claim 1. A method of pausing the display of a received time sequential signal, characterized by the steps of: receiving a time sequential signal; receiving a pause display command; recording a beginning of a first recorded portion of the time sequential signal on a first recording medium; receiving a resume display command; recording an ending of the first recorded portion of the time sequential signal on the first recording medium; determining the beginning of the first recorded portion; playing back the first recorded portion of the time sequential signal; and automatically recording a beginning of a second recorded portion of the time sequential signal on a second recording medium, the second recorded portion being a different part of the time sequential signal than the first recorded portion of the time sequential signal so that the playing back of at least a part of the first recorded portion of the time sequential signal and the automatic recording of at least a part of the second recorded portion of the different part of the time sequential signal take place simultaneously.

Claim 2. A method of pausing the display of a received time sequential signal according to claim 1; wherein the step of determining the beginning of the first recorded portion includes the steps of setting a first start-recording value corresponding with the beginning of the first recorded portion, and using the first start-recording value to determine the beginning of the first recorded portion.

Claim 3. A method of pausing the display of a received time sequential signal according to claim 1, further comprising the steps of;

determining if the ending of the first recorded portion has been played back;

if the ending of the first recorded portion has not been played back, then continuing playing back the first recorded portion of the time sequential signal while recording the second recorded portion of the time sequential signal;

if the ending of the first recorded portion has been played back, then recording an ending of the second recorded portion of the time sequential signal on the second recording medium, determining the beginning of the second recorded portion, and then playing back the second recorded portion of the time sequential signal.

Claim 4. A method of pausing the display of a received time sequential signal according to claim 3, further comprising the steps of;

automatically recording a beginning of a third recorded portion of the time sequential signal on at least one of the first recording medium and a third recording medium;

determining if the ending of the second recorded portion has been played back;

if the ending of the second recorded portion has not been played back, then continuing playing back the second recorded portion of the time sequential signal while recording the third recorded portion of the time sequential signal;

if the ending of the second recorded portion has been played back, then recording an ending of the third recorded portion of the time sequential signal on said at least one of the first recording medium and the third recording medium, determining the beginning of the third recorded portion, and then playing back the third recorded portion of the time sequential signal.

Claim 5. A method of pausing the display of a received time sequential signal according to claim 3; wherein the step of determining if the ending of the first recorded portion has been played back includes the step of setting a first stop-recording value corresponding with the ending of the first recorded portion, and using the first stop-recording value to determine the ending of the first recorded portion.

Claim 6. A method of pausing the display of a received time sequential signal according to claim 1, further comprising the steps of;

determining if the ending of the first recorded portion has been played back;

if the ending of the first recorded portion has not been played back, then determining if a viewer selected function is received, if the viewer selected function is received then performing the viewer selected function while recording the second recorded portion of the time sequential signal, if the viewer selected function is not received then continuing playing back the first recorded portion of the time sequential signal while recording the second recorded portion of the time sequential signal;

if the ending of the first recorded portion has been played back, then recording an ending of the second recorded portion of the time sequential signal on the second recording medium, determining the beginning of the second recorded portion, and then playing back the second recorded portion of the time sequential signal.

Claim 7. A method of pausing the display of a received time sequential signal according to claim 1; further comprising the step of accessing a computer network and receiving network information from the computer network during the recording of at least one of the first recorded portion and the second recorded portion of the time sequential signal.

Claim 8. A method of pausing the display of a received time sequential signal according to claim 1; wherein the time sequential signal comprises video images such as a television program and contains a blanking interval, the blanking interval containing blanking interval information; and further comprising the steps of pausing the display of the video images; and displaying the blanking interval information during the recording of at least one of the first recorded portion and the second recorded portion of the time sequential signal.

Claim 9. A method of pausing the display of a received time sequential signal according to claim 1; wherein the time sequential signal comprises video images such as a television program and contains a blanking interval, the blanking interval containing blanking interval information including a selectable link such as a network address to network information such as a world wide web page from a computer network such as the Internet; and further comprising the steps of receiving the network information depending on the selectable link from the computer network; and displaying the network information during the recording of at least one of the first recorded portion and the second recorded portion of the time sequential signal.

Claim 10. A recording device for pausing the display of a received time sequential signal on a displaying device, characterized by:

recording means for recording a first recorded portion of a received time sequential signal and for recording a second recorded portion of the received time sequential signal, the

second recorded portion being a different part of the received time sequential signal than the first recorded portion of the received time sequential signal;

input receiving means for receiving a pause display command and a resume display command;

determining means for determining the beginning of the first recorded portion;

playing back means for playing back the first recorded portion and the second recorded portion; and

controlling means for controlling the determining means to determine the beginning of the first recorded portion depending on the pause display command, the controlling means for controlling the recording means so that the first recorded portion is recorded depending on the pause display command, the controlling means for controlling the playing back means so that the first recorded portion is played back depending on the determining of the beginning portion by the determining means and depending on the resume display command, and for controlling the recording means so that at least a part of the second recorded portion of the different part of the received time sequential signal is automatically recorded simultaneously while at least a part of the first recorded portion of the received time sequential is being played back.

Claim 11. A recording device according to claim 10; wherein the determining means includes start-recording value setting means for setting a start-recording value, and start-recording value detecting means for detecting the set start-recording value; and the controlling means controls the start-recording value setting means to set the start-recording value depending on the pause display command, and the controlling means controls the playing back means so that the first recorded portion is played back depending on the start-recording value and the resume display command.

Claim 12. A recording device according to claim 11; wherein the determining means further includes stop-recording value setting means for setting a stop-recording value corresponding with an ending of the first recorded portion; and stop-recording value detecting means for detecting the stop-recording value to determine the ending of the first recorded portion.

Claim 13. A recording device according to claim 12; wherein the recording means includes at least one of a magnetic recording medium, an optical recording medium, a magneto-optical recording medium, a phase change recording medium and an electronic recording circuit; the stop-recording value setting means comprises at least one of an audio signal generator, a counter, a file allocation table address generator, a random access memory address generator and a recording medium location address storing means; and the stop-recording value comprises at least one of an audio signal, a counter value, a file allocation table address, a random access memory address and a location on a recording medium.

Claim 14. A recording device according to claim 11; wherein the recording means includes at least one of a magnetic recording medium, an optical recording medium, a magneto-optical recording medium, a phase change recording medium and an electronic recording circuit; the start-recording value setting means comprises at least one of an audio

signal generator, a counter, a file allocation table address generator, and a recording medium location address storing means; and the start-recording value comprises at least one of an audio signal, a counter value, a file allocation table address, a random access memory address and a location on a recording medium.

Claim 15. A recording device according to claim 10; further comprising accessing means for accessing a computer network such as the Internet and receiving network information such as a world wide web page from the computer network and displaying the network information during the recording of the at least one recorded portion of the time sequential signal so that the network information is displayed during the recording of the at least one recorded portion of the time sequential signal.

Claim 16. A recording device according to claim 10; wherein the time sequential signal comprises video images such as a television program and contains a blanking interval, the blanking interval containing blanking interval information including a selectable link such as a network address to network information such as a world wide web page from a computer network such as the Internet; and further comprising accessing means for accessing a computer network such as the Internet and receiving network information such as a world wide web page from the computer network and for displaying the network information during the recording of at least one recorded portion of the time sequential signal so that the network information is displayed during the recording of the at least one recorded portion of the time sequential signal.

Claim 17. An apparatus for pausing the display of a received time sequential signal, characterized by the steps of:

receiving means for receiving a time sequential signal;

input receiving means for receiving a pause display command and a resume display command;

recording means for recording a beginning and an ending of a first recorded portion and for automatically recording a beginning and an ending of a second recorded portion of the time sequential signal, the second recorded portion being a different part of the time sequential signal than the first recorded portion of the received time sequential signal, the beginning of the second recorded portion being automatically recorded depending on the playing-back of the first recorded portion;

determining means including at least one of start-recording value setting means for setting a least one of a first start-recording value corresponding with the beginning of the first recorded portion and a second start-recording value corresponding with the beginning of the second recorded portion; and start-recording value detecting means for detecting the at least one of a first start-recording value and second start-recording value, stop-recording value setting means for setting a least one of a first stop-recording value corresponding with the ending of the first recorded portion and a second stop-recording value corresponding with the ending of the second recorded portion, and stop-recording value detecting means for detecting the at least one of a first stop-recording value and second stop-recording value; and

playing-back means for playing back the first recorded portion of the time sequential signal simultaneously with the automatic recording of the second recorded portion of the different part of the time sequential signal by the recording means.

Claim 18. An apparatus for pausing the display of a received time sequential signal according to claim 17, further comprising; controlling means responsive to the received pause display command and resume display command for controlling the determining means for determining the beginning of the first recorded portion by detecting the first start-recording value, for controlling the playing-back means for playing back the first recorded portion and for controlling the recording means for recording the second recorded portion while the first recorded portion is being played back.

Claim 19. An apparatus for pausing the display of a received time sequential signal according to claim 17, further comprising;

controlling means for controlling the determining means for determining if the ending of the first recorded portion has been played back by detecting the first stop-recording value,

if the ending of the first recorded portion has not been played back, then the controlling means being effective to control the playing-back means for continuing playing back the first recorded portion of the time sequential signal while controlling the recording means for recording the second recorded portion of the time sequential signal, and

if the ending of the first recorded portion has been played back, then the controlling means being effective for controlling the recording means for recording an ending of the second recorded portion, for controlling the determining means for setting a second stop-recording value, for controlling the determining means for determining the beginning of the second recorded portion by detecting the second start-recording value, and then for controlling the playing-back means for playing back the second recorded portion.

Claim 20. An apparatus for pausing the display of a received time sequential signal according to claim 19; wherein the start-recording value setting means being effective for setting a third start-recording value;

the recording means being effective for recording a beginning of a third recorded portion of the time sequential signal;

the controlling means for controlling the determining means for determining if the ending of the second recorded portion has been played back by detecting the second stop-recording value;

if the ending of the second recorded portion has not been played back, then the controlling means for controlling the playing-back means for continuing playing back the second recorded portion of the time sequential signal while recording the third recorded portion of the time sequential signal;

if the ending of the second recorded portion has been played back, then the controlling means for controlling the recording means for recording an ending of the third recorded portion, for controlling the determining means for determining the beginning of the third recorded portion by detecting the third start-recording value, and then for controlling the playing-back means for playing back the third recorded portion.

Claim 21. An apparatus for pausing the display of a received time sequential signal according to claim 17; wherein,

the controlling means controls the determining means for determining if the ending of the first recorded portion has been played back by detecting the first stop-recording value;

if the ending of the first recorded portion has not been played back, then the controlling means for controlling the determining means for determining if a viewer selected function is received, if the viewer selected function is received then performing the viewer selected function while recording the second recorded portion of the time sequential signal, if the viewer selected function is not received then the controlling means for controlling the playing-back means for continuing playing back the first recorded portion of the time sequential signal while recording the second recorded portion of the time sequential signal;

if the ending of the first recorded portion has been played back, then the controlling means for controlling the recording means for recording an ending of the second recorded portion of the time sequential signal on the first recording medium, and then

the controlling means for controlling the playing-back means for playing back the second recorded portion of the time sequential signal using the second start-recording value to determine the beginning of the second recorded portion.

Claim 22. An apparatus for pausing the display of a received time sequential signal according to claim 17; wherein at least one of the start-recording value setting means and the stop-recording value setting means includes a tone signal generator for generating a respective tone signal recorded as the start-recording value and the stop-recording value for determining the beginning and the ending, respectively, when recording the recorded portions of the time sequential signal, and at least one of the start-recording value detecting means and the stop-recording value detecting means includes a tone signal detector for detecting each said recorded tone signal for determining the beginning and the ending, respectively, when playing back the recorded portions of the time sequential signal.

Claim 23. An apparatus for pausing the display of a received time sequential signal according to claim 17; wherein at least one of the start-recording value setting means and the stop-recording value setting means includes a file allocation table address generator for generating and storing a respective file allocation table address as the start-recording value and the stop-recording value for determining the beginning and the ending, respectively, when recording the recorded portions of the time sequential signal, and at least one of the start-recording value detecting means and the stop-recording value detecting means includes a file allocation table address retrieving means for retrieving each said stored file allocation table address for determining the beginning and the ending, respectively, when playing back the recorded portions of the time sequential signal.

Claim 24. An apparatus for pausing the display of a received time sequential signal according to claim 17; wherein at least one of the start-recording value setting means and the stop-recording value setting means includes a counter for generating and storing a corresponding counter value as the start-recording value and the stop-recording value for determining the beginning and the ending, respectively, when recording the recorded portions

of the time sequential signal, and at least one of the start-recording value detecting means and the stop-recording value detecting means includes a counter value detector for retrieving each stored counter value for determining the beginning and the ending, respectively, when playing back the recorded portions of the time sequential signal.

Claim 25. An apparatus for pausing the display of a received time sequential signal according to claim 17; wherein the start-recording value setting means includes means for setting a predetermined start-recording value comprised of at least one a predetermined counter value, a predetermined file allocation table address, of a predetermined location on a recording medium and a predetermined random access memory address for setting a predetermined start-recording value for determining the beginning of the recorded portions of the time sequential signal, and wherein the stop-recording value setting means includes at least one of a tone signal generator for generating a tone signal, a file allocation table address generator for generating and storing a file allocation table address, a counter for generating and storing a counter value and a random access memory address generator for generating a random access memory address as the stop-recording value for determining the ending when recording the recorded portions of the time sequential signal.

Claim 26. A recording device according to claim 17; further comprising accessing means for accessing a computer network such as the Internet and receiving network information such as a world wide web page from the computer network and displaying the network information during the recording of the at least one recorded portion of the time sequential signal so that the network information is displayed during the recording of the at least one recorded portion of the time sequential signal.

Claim 27. A recording device according to claim 17; wherein the time sequential signal comprises video images such as a television program and contains a blanking interval, the blanking interval containing blanking interval information including a selectable link such as a network address to network information such as a world wide web page from a computer network such as the Internet; and further comprising accessing means for accessing a computer network such as the Internet and receiving network information such as a world wide web page from the computer network and for displaying the network information during the recording of at least one recorded portion of the time sequential signal so that the network information is displayed during the recording of the at least one recorded portion of the time sequential signal.

Claim 28. An auto-editing device, capable of recording an event on a recording medium, characterized by: event-recording means for recording an event on a recording medium; selecting means for selecting at least one edit-record interval corresponding to a respective selected portion of the recorded event; signal generating means for generating a start-record signal dependent on each said selected edit-record interval; signal recording means for recording each said start-signal on the recording medium; signal detecting means for detecting during a subsequent edit-recording operation each said start-record signal from the recording medium; controlling means for controlling the event-recording means and an edited-recording means during the edit-recording operation so that a play-back operation to



play-back the event from the recording medium is performed by the event-recording means and a record operation to record an edited version of the event is performed by the edited-recording means, the controlling means being effective for controlling the record operation during the subsequent edit-recording operation dependent on each said detected start-record signal to record a copy of the recorded event having each said selected edit-record interval.

Claim 29. An auto-editing device according to claim 28; wherein the controlling means includes means for controlling the event recording means to fast forward the recording medium through periods of the recorded event that are not said selected edit-record interval.

Claim 30. An auto-editing device according to claim 28; wherein the selecting means includes means for selecting a beginning time of said edit-record interval occurring at a time prior to a time that the edit-record interval is selected; the signal generating means includes means for generated the start-record signal including a beginning time data; and the controlling means includes means for rewinding the event-recording means to the beginning time of said edit-record interval dependent on the start-record signal and the beginning time data.

Claim 31. An auto-editing device according to claim 28; wherein the selecting means includes means for selecting an edit-version for each said edit record interval; the signal generating means includes means for generating the start-record signal including an edit-version data; and the controlling means includes means for controlling the event-recording means and the edit-recording means so that the edit-recording means records the copy of the recorded event having each said selected edit-record interval being the same edit-version.

Claim 32. An auto-editing device for at least two recording apparatus capable of simultaneously recording an event on a respective recording medium, characterized by ; selecting means for selecting between at least a first edit-record interval corresponding to a perspective of the event being recorded taken by a first recording apparatus and a second edit-record interval corresponding to a second perspective of the event being recorded taken by a second recording apparatus; signal generating means for generating a corresponding start-record signal dependent on the selected edit-record interval; signal recording means for recording each start-signal on a recording medium; signal detecting means for detecting during a subsequent edit-recording operation the start-record signal from the recording medium; and edit-record controlling means for controlling a recording device during the subsequent edit-recording operation dependent on each detected start-record signal to record a single copy of the recorded event having at least the first perspective of the event being recorded taken by the first recording apparatus and the second perspective of the event being recorded taken by the second recording apparatus.

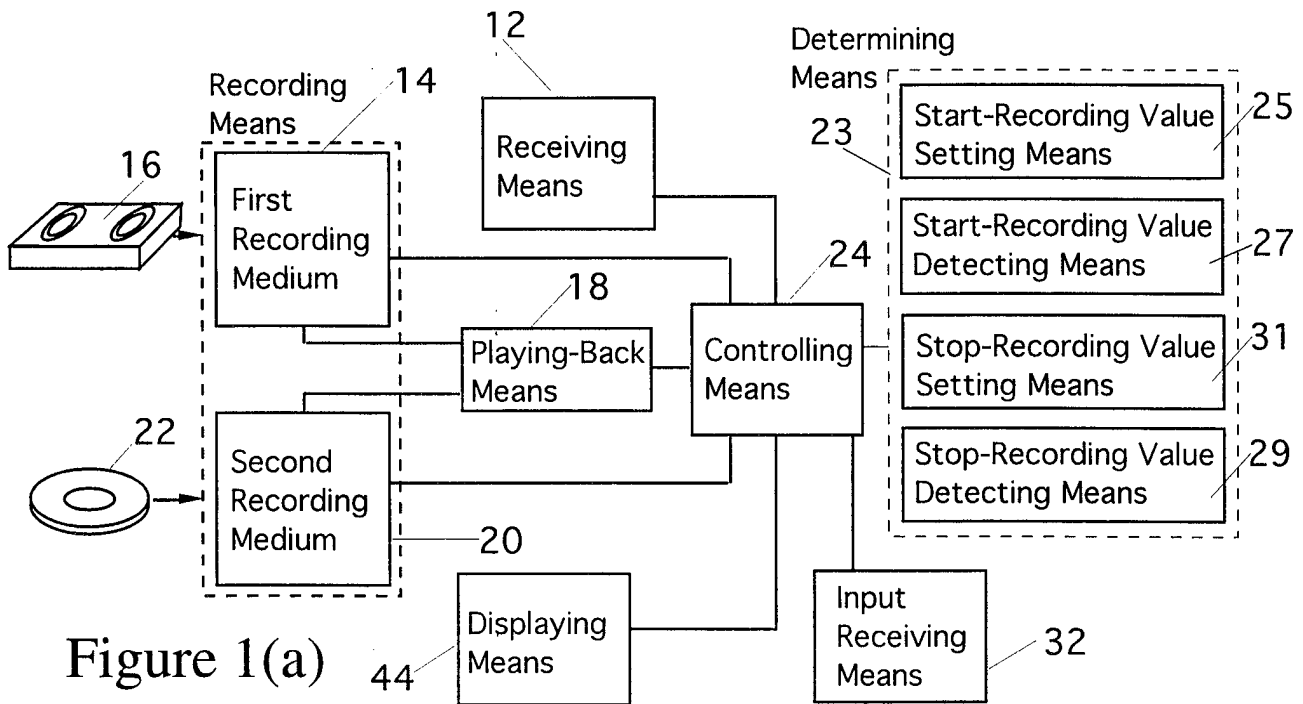

Figure 1(a)

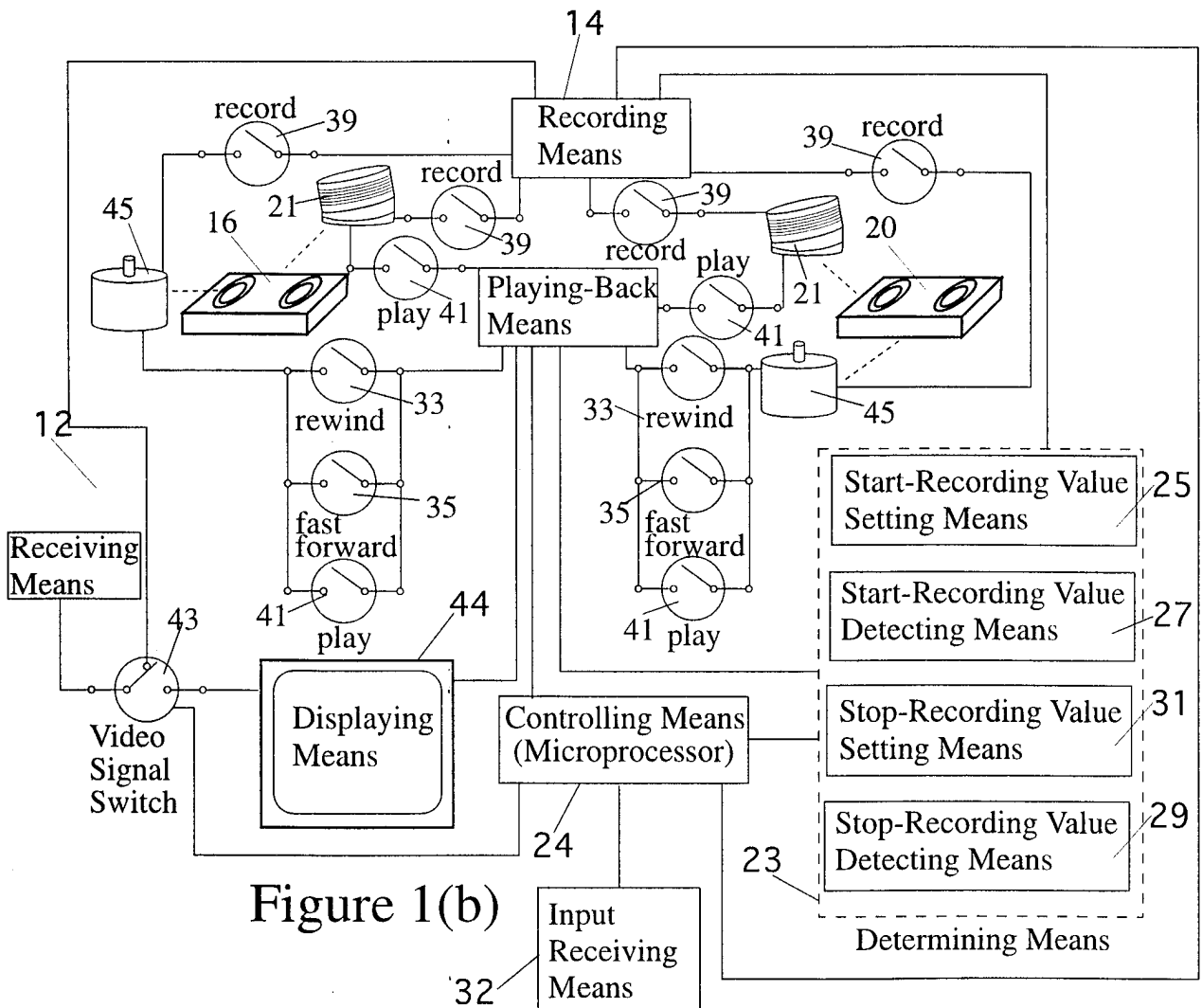

Figure 1(b)

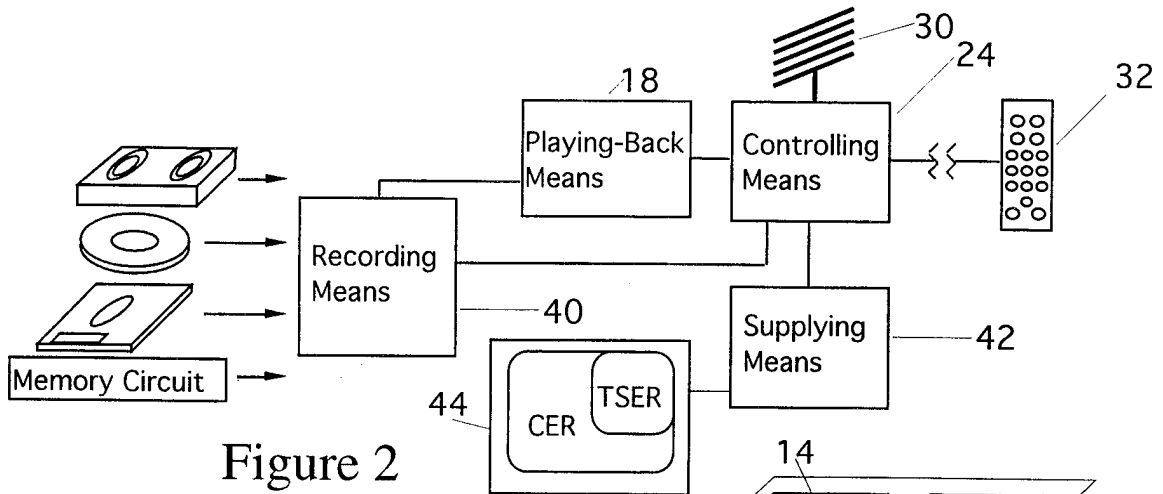

Figure 2

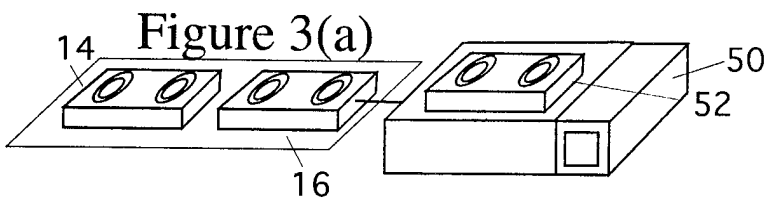

Figure 3(a)

Figure 3(b)

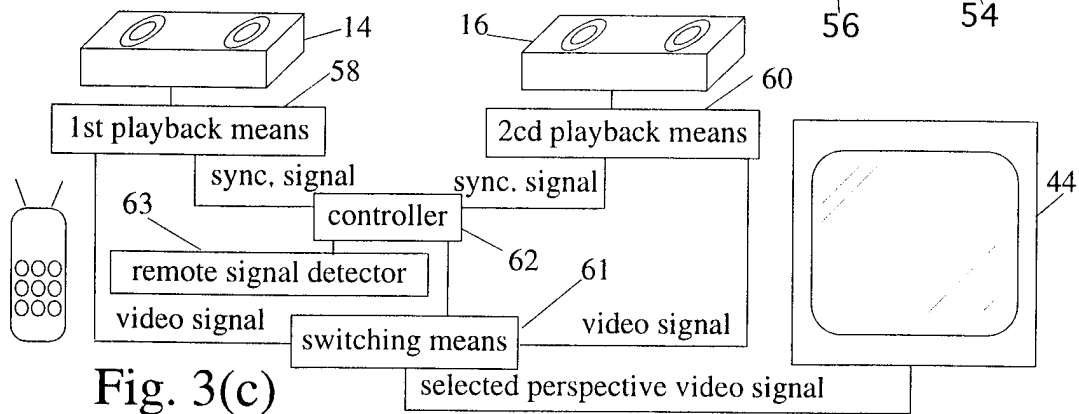
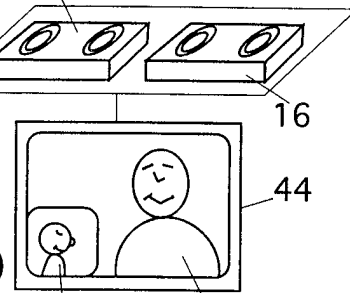

Fig. 3(c)

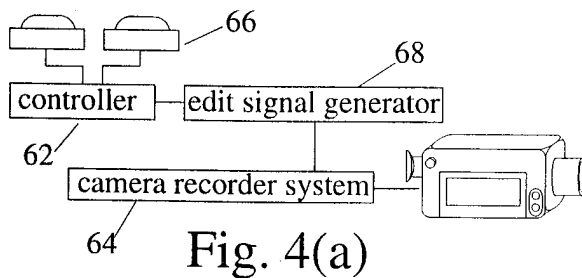

Fig. 4(a)

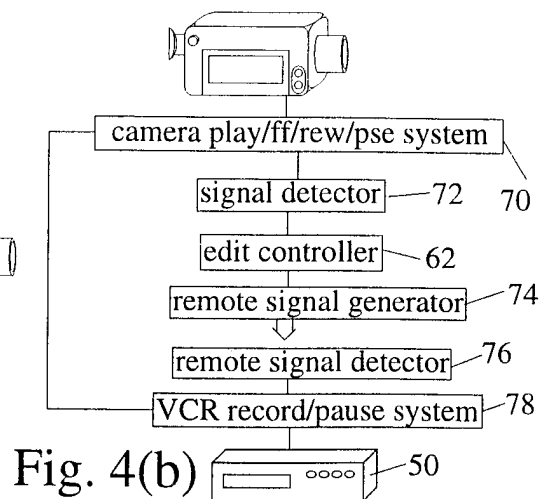

Fig. 4(b)

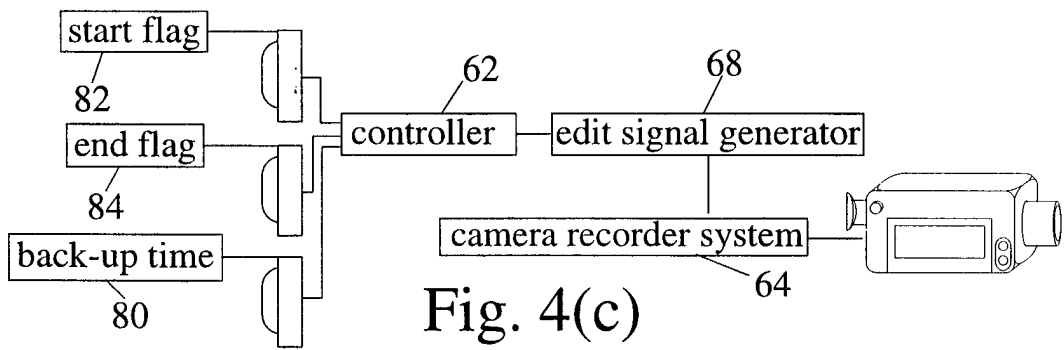

Fig. 4(c)

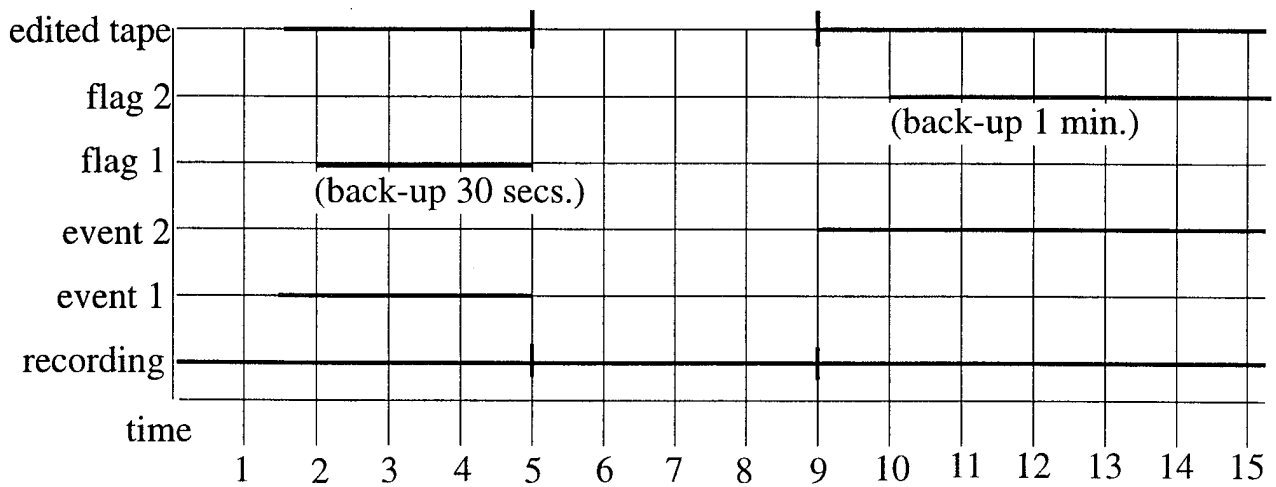

Fig. 4(d)

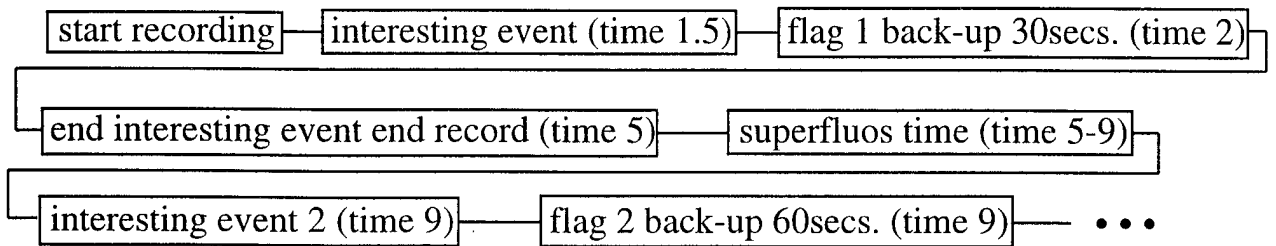

Fig. 4(e)

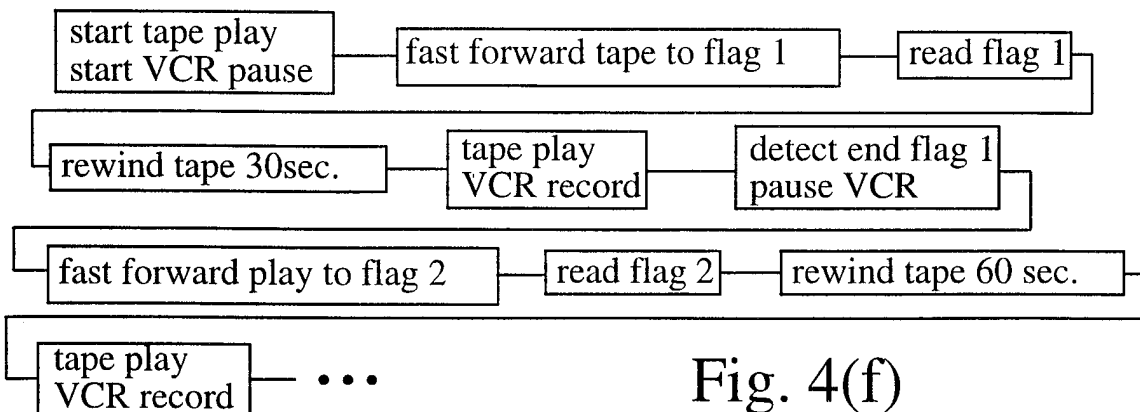

Fig. 4(f)

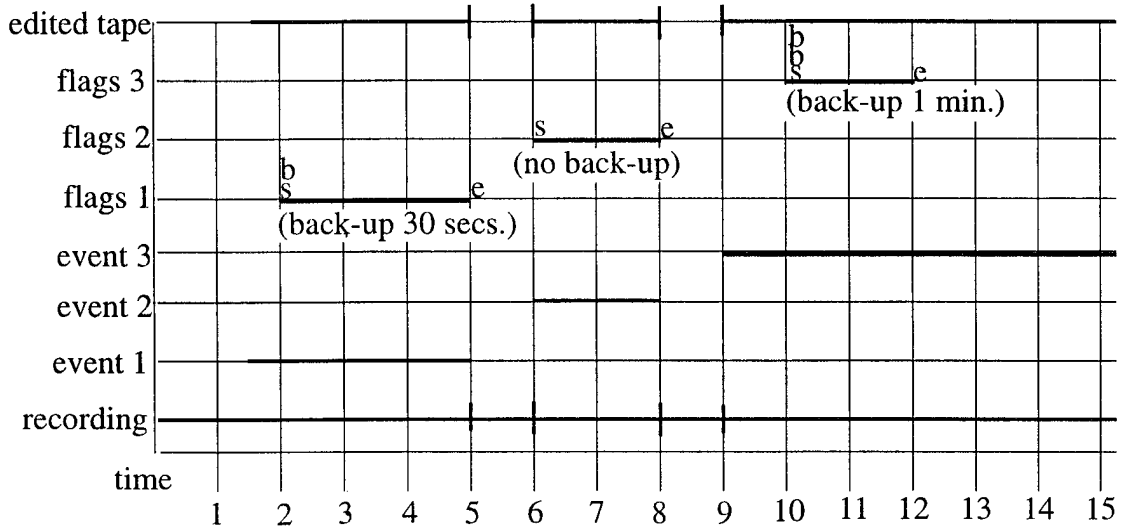

Fig. 4(g)

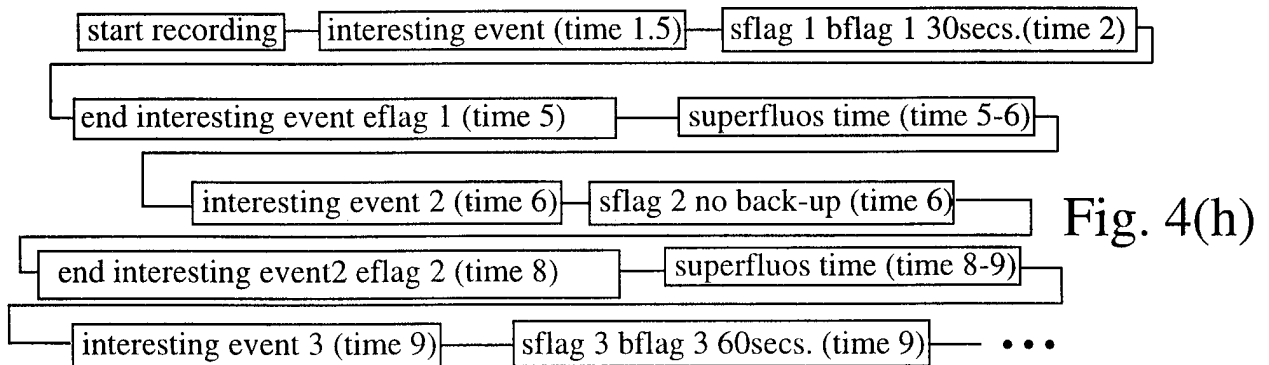

Fig. 4(h)

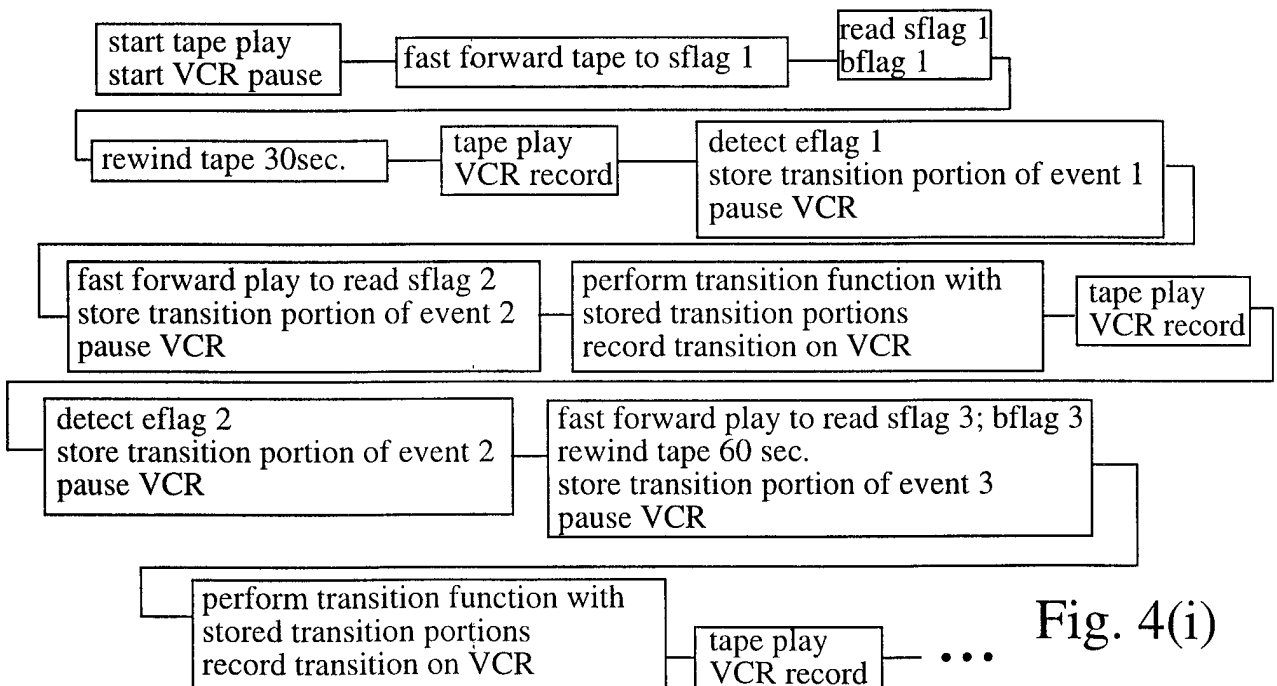

Fig. 4(i)

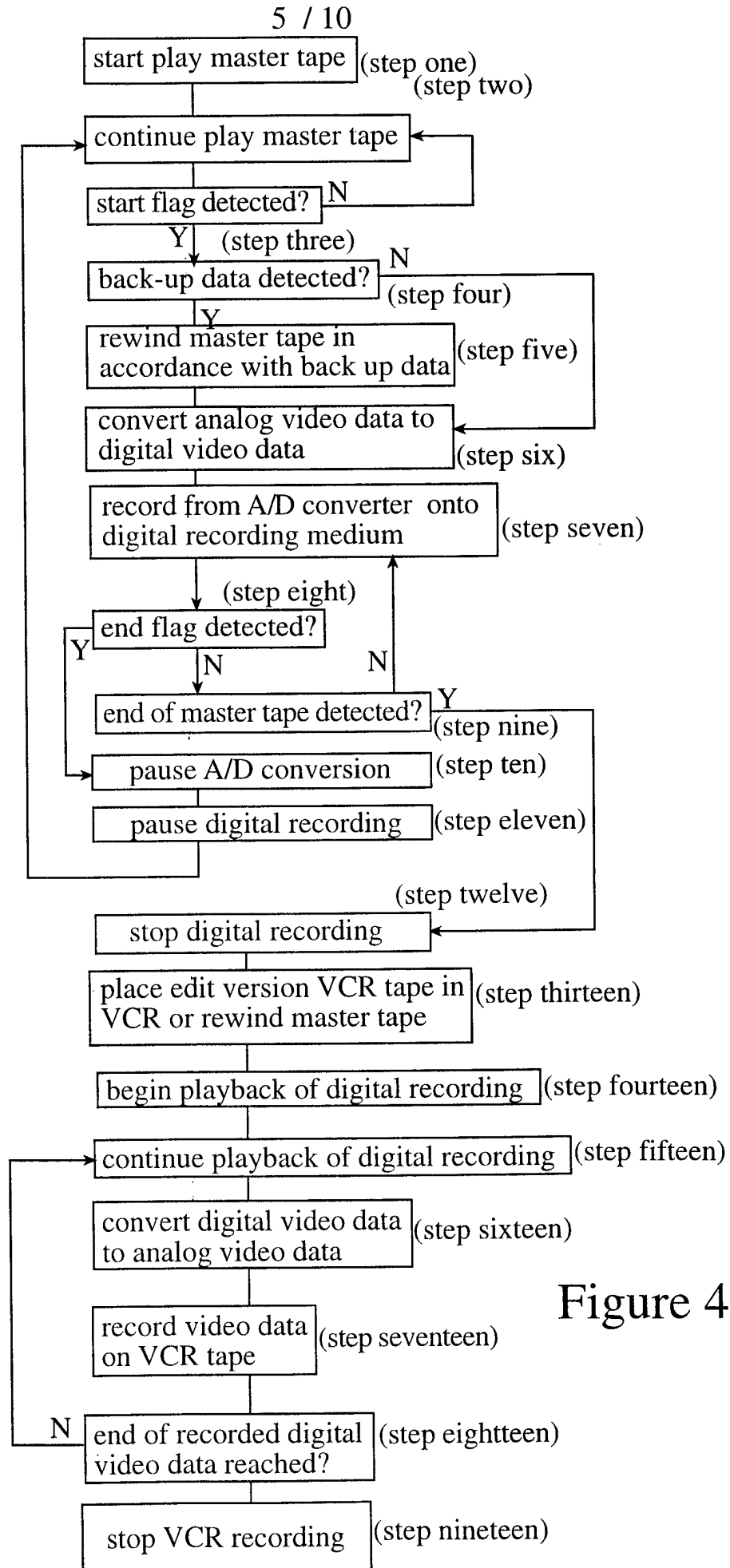

Figure 4(k)

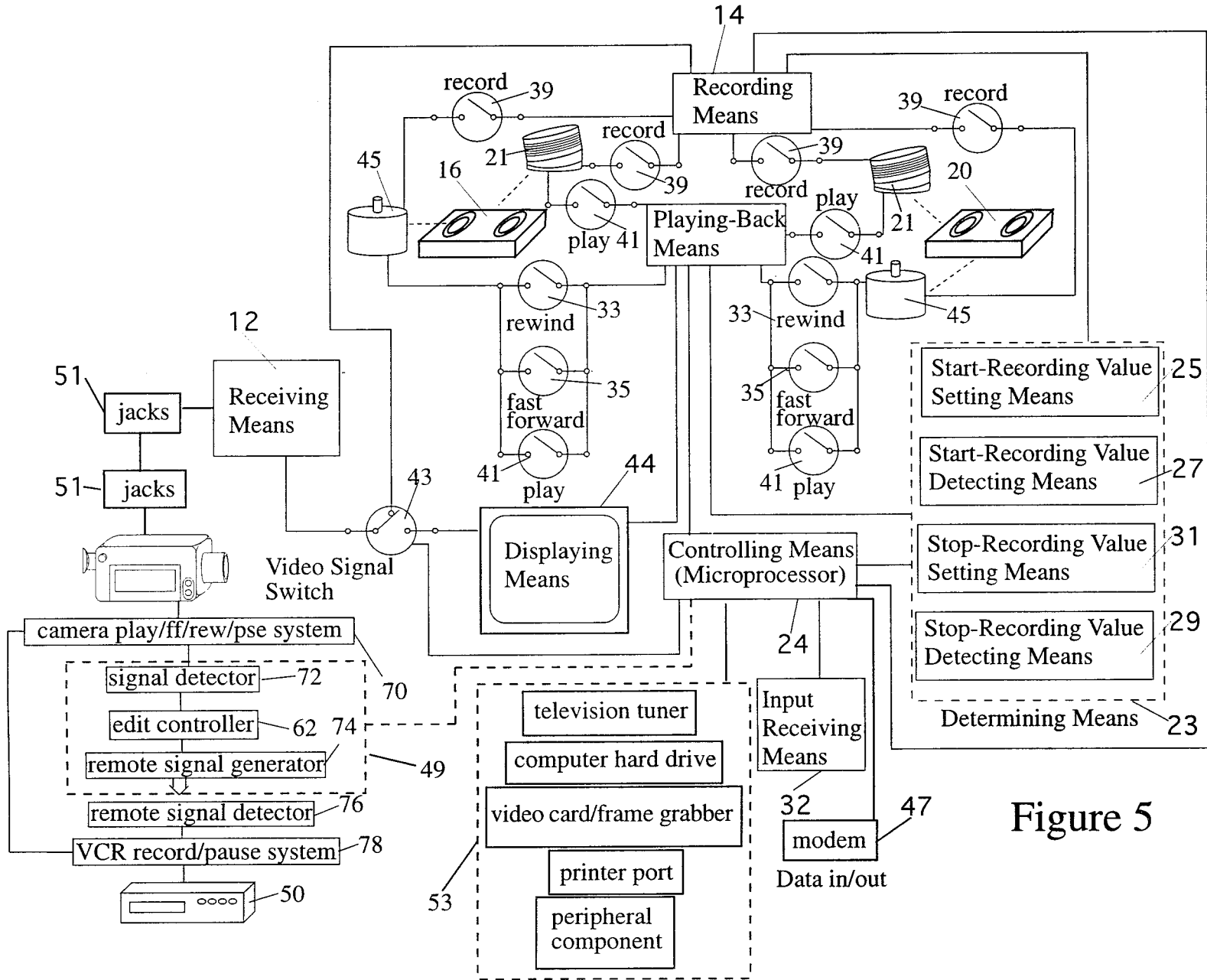

Figure 5

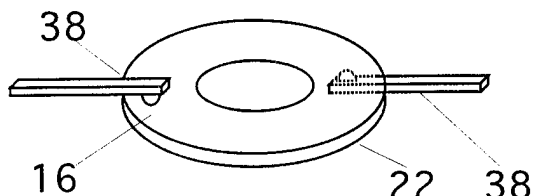
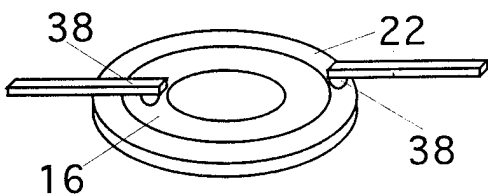
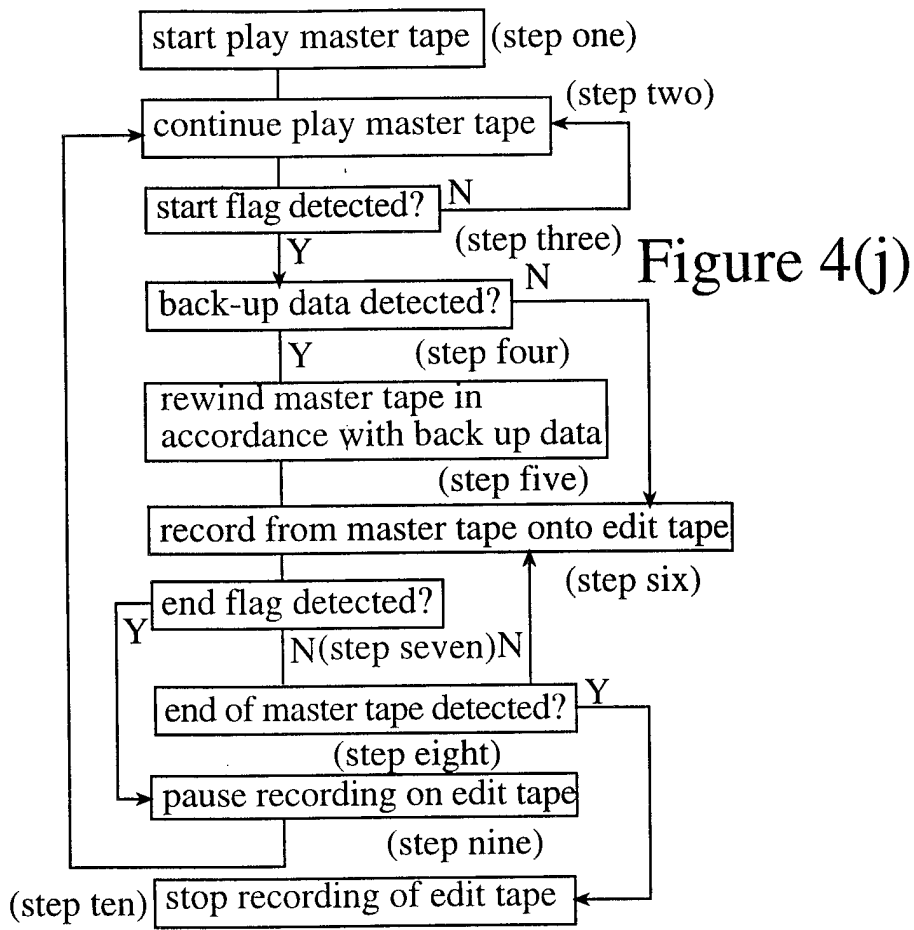
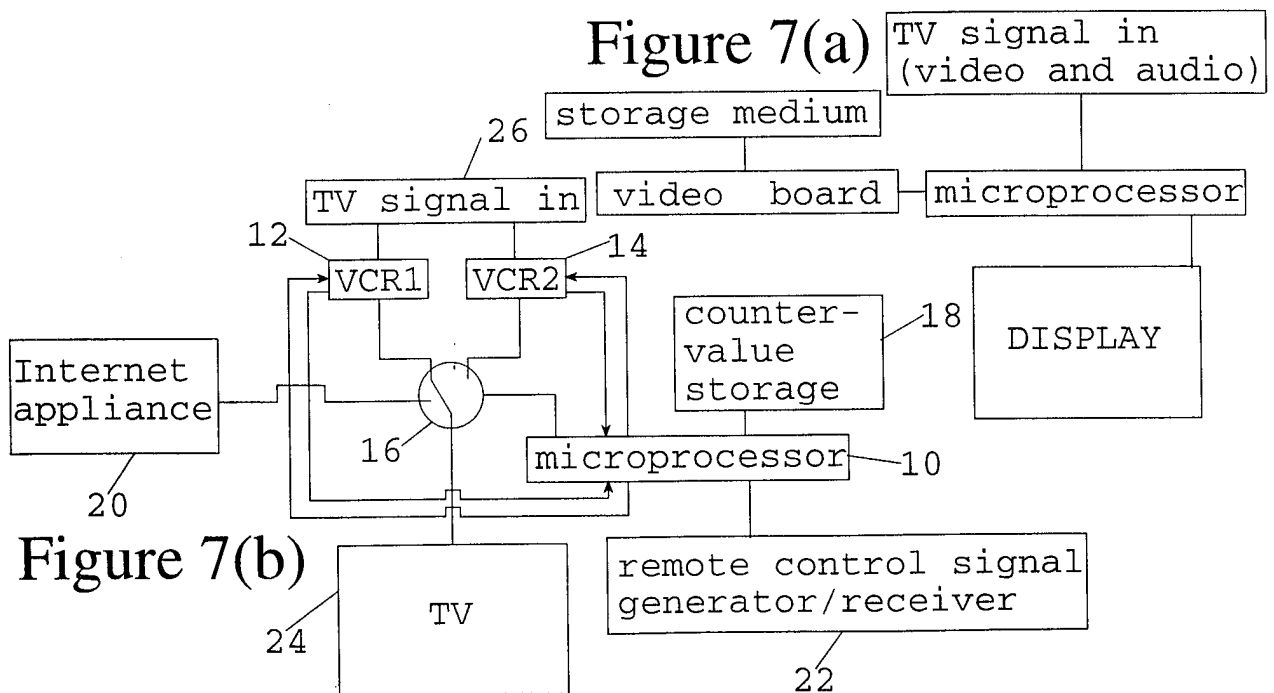

Figure 6(a)

Figure 6(b)





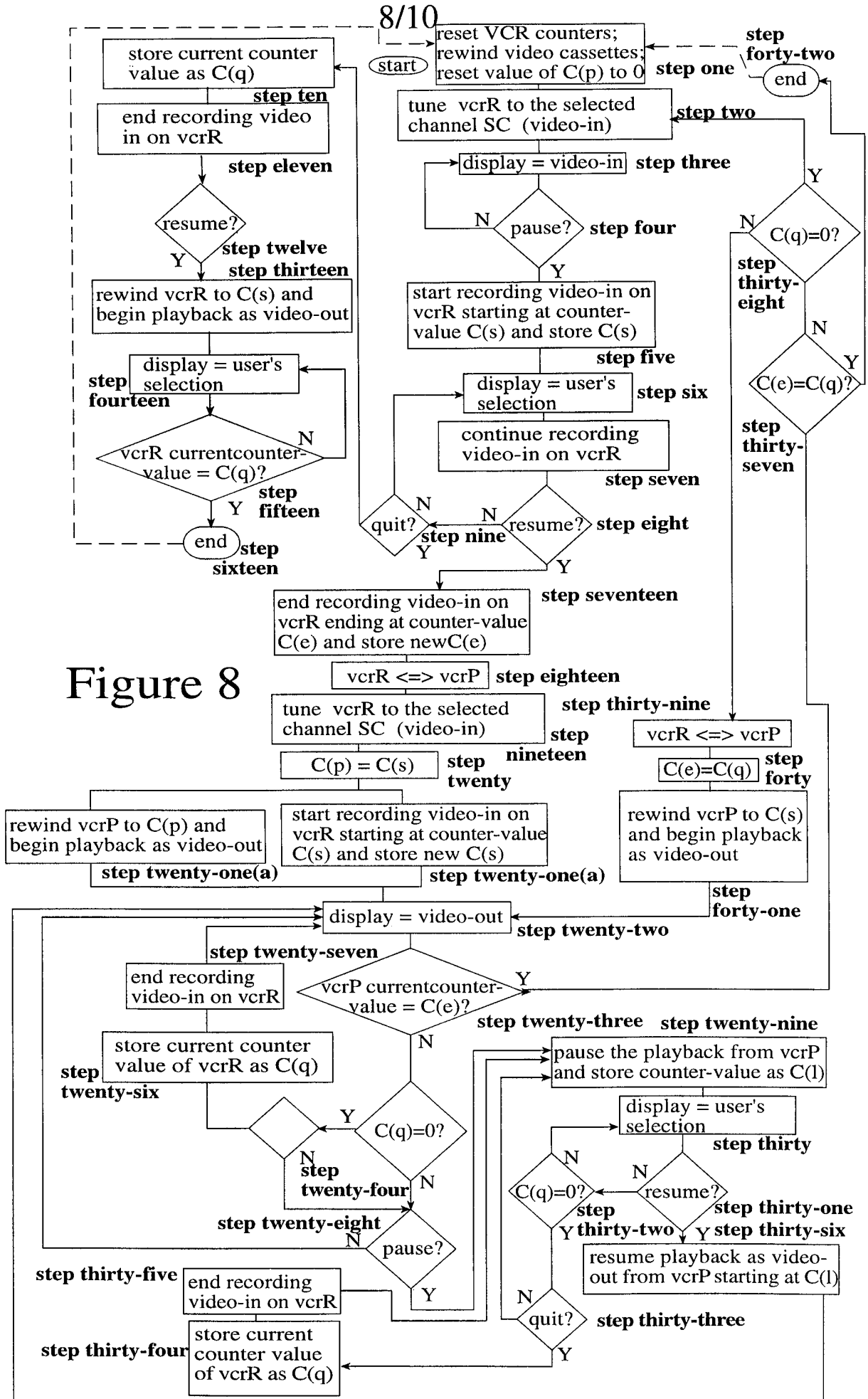

Figure 8

9/10

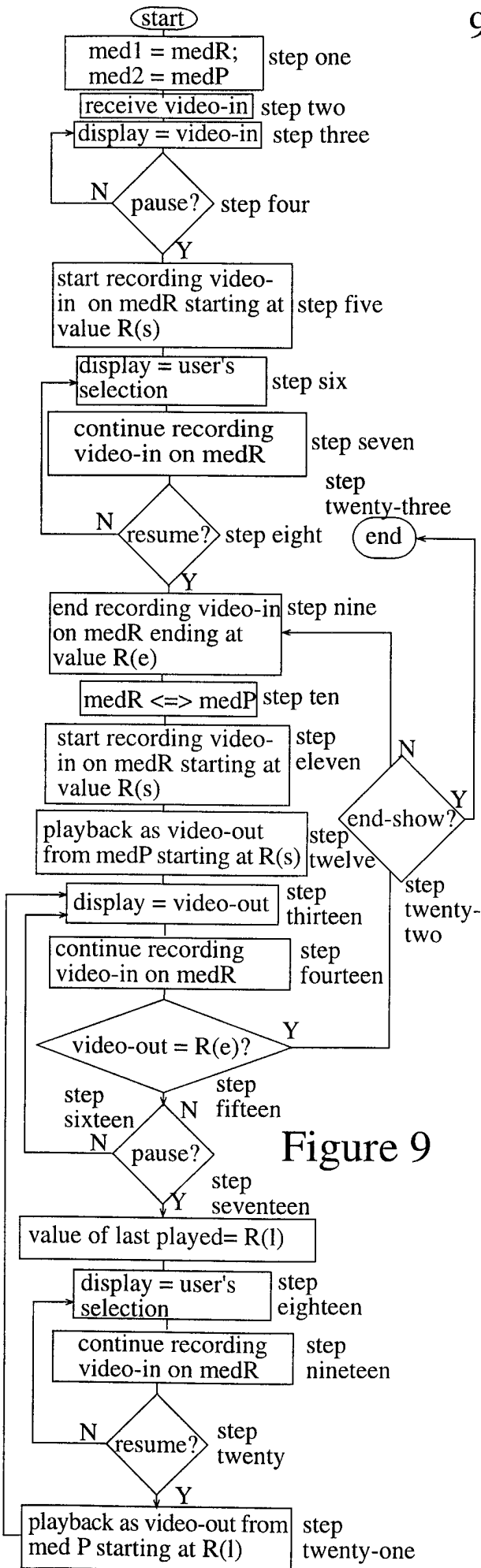

Figure 9

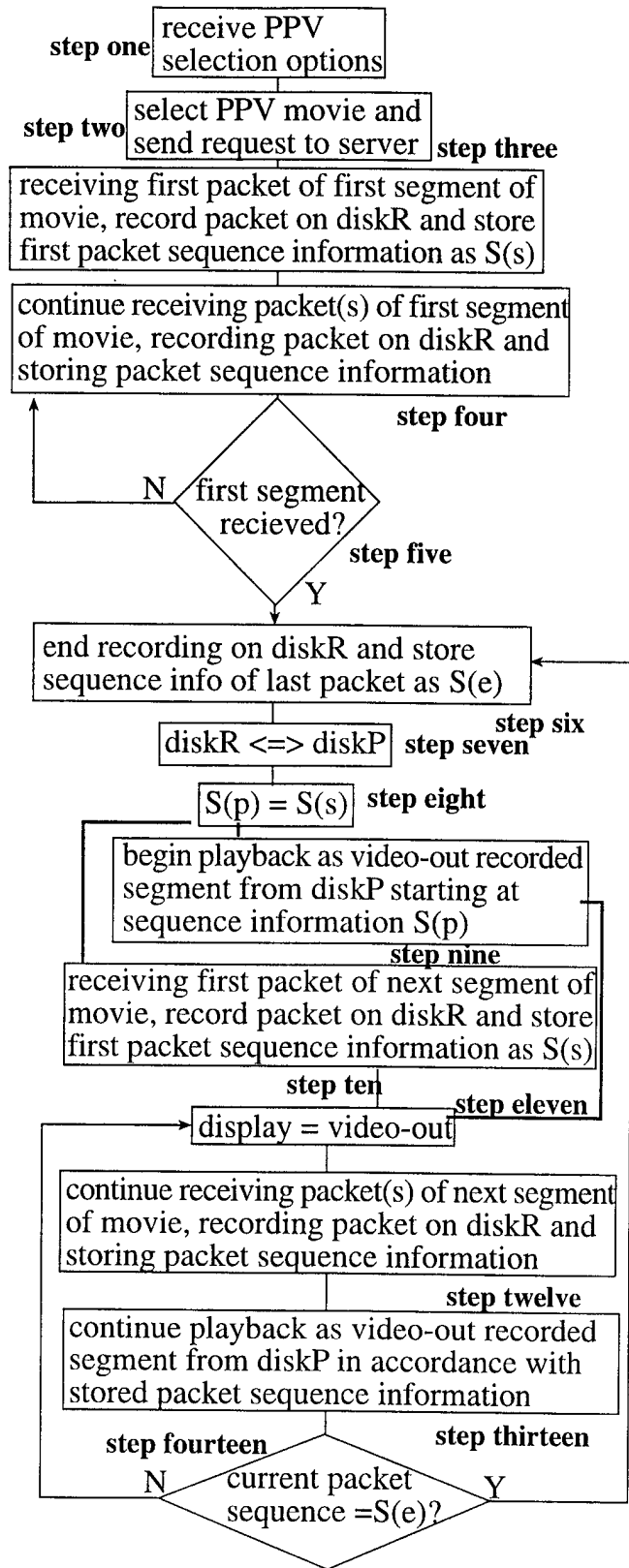

Figure 10

| elapsed time<br>record packets<br>of movie<br>minutes |    |    | playback of<br>movie |
|---|----|----|----------------------|
| 1   | 1  | 2  |                      |
| 2   | 3  | 4  |                      |
| 3   | 5  | 6  |                      |
| 4   | 7  | 8  |                      |
| 5   | 9  | 10 |                      |
| 6   | 11 | 12 |                      |
| 7   | 13 | 14 |                      |
| 8   | 15 | 16 |                      |
| 9   | 17 | 18 |                      |
| 10  | 19 | 20 |                      |
| 11  | 21 | 22 |                      |
| 12  | 23 | 24 |                      |
| 13  | 25 | 26 |                      |
| 14  | 27 | 28 |                      |
| 15  | 29 | 30 |                      |
| 16  |    |    | 1                    |
| 17  |    |    | 2                    |
| 18  |    |    | 3                    |
| 19  |    |    | 4                    |
| 20  |    |    | 5                    |
| 21  |    |    | 6                    |
| 22  |    |    | 7                    |
| 23  |    |    | 8                    |
| 24  |    |    | 9                    |
| 25  |    |    | 10                   |
| 26  |    |    | 11                   |
| 27  |    |    | 12                   |
| 28  |    |    | 13                   |
| 29  |    |    | 14                   |
| 30  |    |    | 15                   |
| 31  |    |    | 16                   |
| 32  |    |    | 17                   |
| 33  |    |    | 18                   |
| 34  |    |    | 19                   |
| 35  |    |    | 20                   |
| 36  |    |    | 21                   |
| 37  |    |    | 22                   |
| 38  |    |    | 23                   |
| 39  |    |    | 24                   |
| 40  |    |    | 25                   |
| 41  |    |    | 26                   |
| 42  |    |    | 27                   |
| 43  |    |    | 28                   |
| 44  |    |    | 29                   |
| 45  |    |    | 30                   |

| elapsed time<br>disk1 record packets<br>of movie minutes |    |    | disk1 playback of movie<br>disk2 playback of movie |    | disk2 record packets<br>of movie minutes |    |
|--|----|----|--|----|--|----|
| 1  | 1  | 2  |  |    |  |    |
| 2  |    |    | 1  |    |  |    |
| 3  |    |    | 2  |    |  |    |
| 4  | 7  | 8  |  | 3  |  |    |
| 5  | 9  | 10 |  | 4  |  |    |
| 6  | 11 | 12 |  | 5  |  |    |
| 7  | 13 | 14 |  | 6  |  |    |
| 8  |    |    |  | 7  | 15                                       | 16 |
| 9  |    |    |  | 8  | 17                                       | 18 |
| 10   |    |    |  | 9  | 19                                       | 20 |
| 11   |    |    |  | 10 | 21                                       | 22 |
| 12   |    |    |  | 11 | 23                                       | 24 |
| 13   |    |    |  | 12 | 25                                       | 26 |
| 14   |    |    |  | 13 | 27                                       | 28 |
| 15   |    |    |  | 14 | 29                                       | 30 |
| 16   |    |    | 15   |    |  |    |
| 17   |    |    | 16   |    |  |    |
| 18   |    |    | 17   |    |  |    |
| 19   |    |    | 18   |    |  |    |
| 20   |    |    | 19   |    |  |    |
| 21   |    |    | 20   |    |  |    |
| 22   |    |    | 21   |    |  |    |
| 23   |    |    | 22   |    |  |    |
| 24   |    |    | 23   |    |  |    |
| 25   |    |    | 24   |    |  |    |
| 26   |    |    | 25   |    |  |    |
| 27   |    |    | 26   |    |  |    |
| 28   |    |    | 27   |    |  |    |
| 29   |    |    | 28   |    |  |    |
| 30   |    |    | 29   |    |  |    |
| 31   |    |    | 30   |    |  |    |

Figure 11(b)

Figure 11(a)  
prior art

| elapsed time<br>disk1 record packets<br>of movie minutes |    |    |    | disk1 playback of movie<br>disk2 playback of movie |   |    |    | disk2 record packets<br>of movie minutes |    |    |    |
|--|----|----|----|--|---|----|----|--|----|----|----|
| 1  | 1  | 2  | 3  | 4  |   |    |    |  |    |    |    |
| 2  |    |    |    |  | 1 |    |    | 5  | 6  | 7  | 8  |
| 3  |    |    |    |  | 2 |    |    | 9  | 10 | 11 | 12 |
| 4  |    |    |    |  | 3 |    |    | 13                                       | 14 | 15 | 16 |
| 5  |    |    |    |  | 4 |    |    | 17                                       | 18 | 19 | 20 |
| 6  | 21 | 22 | 23 | 24   |   | 5  |    |  |    |    |    |
| 7  | 25 | 26 | 27 | 28   |   | 6  |    |  |    |    |    |
| 8  | 29 | 30 |    |  |   | 7  |    |  |    |    |    |
| 9  |    |    |    |  |   | 8  |    |  |    |    |    |
| 10   |    |    |    |  |   | 9  |    |  |    |    |    |
| 11   |    |    |    |  |   | 10 |    |  |    |    |    |
| 12   |    |    |    |  |   | 11 |    |  |    |    |    |
| 13   |    |    |    |  |   | 12 |    |  |    |    |    |
| 14   |    |    |    |  |   | 13 |    |  |    |    |    |
| 15   |    |    |    |  |   | 14 |    |  |    |    |    |
| 16   |    |    |    |  |   | 15 |    |  |    |    |    |
| 17   |    |    |    |  |   | 16 |    |  |    |    |    |
| 18   |    |    |    |  |   | 17 |    |  |    |    |    |
| 19   |    |    |    |  |   | 18 |    |  |    |    |    |
| 20   |    |    |    |  |   | 19 |    |  |    |    |    |
| 21   |    |    |    |  |   | 20 |    |  |    |    |    |
| 22   |    |    |    |  |   |    | 21 |  |    |    |    |
| 23   |    |    |    |  |   |    | 22 |  |    |    |    |
| 24   |    |    |    |  |   |    | 23 |  |    |    |    |
| 25   |    |    |    |  |   |    | 24 |  |    |    |    |
| 26   |    |    |    |  |   |    | 25 |  |    |    |    |
| 27   |    |    |    |  |   |    | 26 |  |    |    |    |
| 28   |    |    |    |  |   |    | 27 |  |    |    |    |
| 29   |    |    |    |  |   |    | 28 |  |    |    |    |
| 30   |    |    |    |  |   |    | 29 |  |    |    |    |
| 31   |    |    |    |  |   |    | 30 |  |    |    |    |

Figure 11(c)

INTERNATIONAL SEARCH REPORT

International application No.  
PCT/US97/18372

A. CLASSIFICATION OF SUBJECT MATTER

IPC(6) :H04N 5/76  
US CL :386/46

According to International Patent Classification (IPC) or to both national classification and IPC

B. FIELDS SEARCHED

Minimum documentation searched (classification system followed by classification symbols)

U.S. : 386/46, 1, 4, 45, 52, 55, 64, 83, 95, 125, 126; 360/13, 72.1, 72.2; 348/464, 468

Documentation searched other than minimum documentation to the extent that such documents are included in the fields searched

NONE

Electronic data base consulted during the international search (name of data base and, where practicable, search terms used)

APS

search terms: wide web#, blanking interval#, tone, record?, identif?, determin?, and id#.

C. DOCUMENTS CONSIDERED TO BE RELEVANT

| Category*     | Citation of document, with indication, where appropriate, of the relevant passages | Relevant to claim No.                                       |
|---------------|--|---|
| X<br>---<br>Y | US 4,768,110 A (DUNLAP ET AL) 30 August 1988, Fig. 3.                              | 1-6, 10-12, and 17-21<br>-----<br>7-9, 13-16, 22-27, and 32 |
| X<br>---<br>Y | US 5,333,091 A (IGGULDEN ET AL) 26 July 1994, Fig. 2 and column 4, lines 53-68.    | 28-31<br>-----<br>32  |
| Y             | US 5,488,409 A (YUEN ET AL) 30 January 1996, Figs. 1-2.                            | 7-9, 13-16, and 22-27                                       |
| Y             | US 5,570,014 A (MULLER ET AL) 29 October 1996, column 6, lines 3-20.               | 22 and 25   |

Further documents are listed in the continuation of Box C.  See patent family annex.

|   |  |
|---|--|
| * Special categories of cited documents:  | *T* later document published after the international filing date or priority date and not in conflict with the application but cited to understand the principle or theory underlying the invention  |
| *A* document defining the general state of the art which is not considered to be of particular relevance  | *X* document of particular relevance; the claimed invention cannot be considered novel or cannot be considered to involve an inventive step when the document is taken alone   |
| *E* earlier document published on or after the international filing date  | *Y* document of particular relevance; the claimed invention cannot be considered to involve an inventive step when the document is combined with one or more other such documents, such combination being obvious to a person skilled in the art |
| *L* document which may throw doubts on priority claim(s) or which is cited to establish the publication date of another citation or other special reason (as specified) | *G* document member of the same patent family  |
| *O* document referring to an oral disclosure, use, exhibition or other means  |  |
| *P* document published prior to the international filing date but later than the priority date claimed  |  |

Date of the actual completion of the international search

02 JANUARY 1998

Date of mailing of the international search report

10 FEB 1998

Name and mailing address of the ISA/US  
Commissioner of Patents and Trademarks  
Box PCT  
Washington, D.C. 20231

Facsimile No. (703) 305-3230

Authorized officer

THAI TRAN

Telephone No. (703) 305-4725

## INTERNATIONAL SEARCH REPORT

International application No.  
PCT/US97/18372

## C (Continuation). DOCUMENTS CONSIDERED TO BE RELEVANT

| Category* | Citation of document, with indication, where appropriate, of the relevant passages      | Relevant to claim No. |
|-----------|---|-----------------------|
| Y         | US 4,677,501 A (SALTZMAN ET AL) 30 June 1987, column 8, line 63 to column 9, line 21.   | 22 and 25             |
| A         | US 4,729,044 A (KIESEL) 01 March 1988, Fig. 3.  | 1-32                  |
| A         | US 5,182,677 A (KIZU ET AL) 26 January 1993, Figs. 3-4.                                 | 1-32                  |
| A         | US 5,280,392 A (KOO) 18 January 1994, Fig. 1 and column 3, line 65 to column 4, line 2. | 1-32                  |