



US00D772846S

(12) **United States Design Patent** (10) **Patent No.:** **US D772,846 S**
Watanabe (45) **Date of Patent:** **** Nov. 29, 2016**

(54) **COMBINED HEADPHONE AND AUDIO PLAYER**

(71) Applicant: **Sony Corporation**, Tokyo (JP)

(72) Inventor: **Koki Watanabe**, Saitama (JP)

(73) Assignee: **Sony Corporation**, Tokyo (JP)

(**) Term: **15 Years**

(21) Appl. No.: **29/529,762**

(22) Filed: **Jun. 10, 2015**

Related U.S. Application Data

(63) Continuation-in-part of application No. 29/496,002, filed on Jul. 8, 2014, now Pat. No. Des. 745,862, which is a continuation-in-part of application No. 29/421,750, filed on Sep. 14, 2012, now Pat. No. Des. 709,051, which is a continuation-in-part of application No. 29/371,743, filed on Aug. 18, 2011, now Pat. No. Des. 667,817.

(30) **Foreign Application Priority Data**

Feb. 18, 2011 (CN) 2011 3 0025880

(51) **LOC (10) Cl.** **14-01**

(52) **U.S. Cl.**
USPC **D14/223; D14/217**

(58) **Field of Classification Search**

USPC D14/192, 194, 204, 205, 156, 223, 248, D14/249, 137, 138, 142, 138 AD, 147, 148, D14/188, 496, 160, 168, 217, 265; D8/349, D8/14, 21, 29.1, 61, 63; D24/106, 110, 381/312, 315, 72, 74, 73.1, 23.1, 328, 381/329, 150, 151, 370, 376; 181/122, 129, 181/130, 135, 137; 455/1, 440, 344-351, 455/90.3, 575.1, 565; 200/5 B, 5 EB, 200/547-550
CPC H04R 1/10; H04R 1/105; H04R 25/00; H04R 25/02

See application file for complete search history.

(56) **References Cited**

U.S. PATENT DOCUMENTS

4,571,746 A 2/1986 Gorike
5,279,294 A 1/1994 Anderson et al.
5,579,669 A 12/1996 Kind et al.

(Continued)

Primary Examiner — Prabhakar Deshmukh

(74) *Attorney, Agent, or Firm* — Michael Best and Friedrich LLP

(57) **CLAIM**

The ornamental design for a combined headphone and audio player, as shown.

DESCRIPTION

FIG. 1 is a rear, bottom, left perspective view of a first embodiment of a combined headphone and audio player showing our new design;

FIG. 2 is a front elevational view thereof;

FIG. 3 is a rear elevational view thereof;

FIG. 4 is a left side elevational view thereof;

FIG. 5 is a right side elevational view thereof;

FIG. 6 is a top plan view thereof; and

FIG. 7 is a bottom plan view thereof;

FIG. 8 is a front, top, right perspective view of a second embodiment of a combined headphone and audio player showing our new design;

FIG. 9 is a rear, bottom, right perspective view thereof;

FIG. 10 is a front elevational view thereof;

FIG. 11 is a rear elevational view thereof;

FIG. 12 is a left side elevational view thereof;

FIG. 13 is a right side elevational view thereof;

FIG. 14 is a top plan view thereof; and,

FIG. 15 is a bottom plan view thereof.

The broken lines illustrate unclaimed portions of the combined headphone and audio player and form no part of the claimed design.

1 Claim, 11 Drawing Sheets

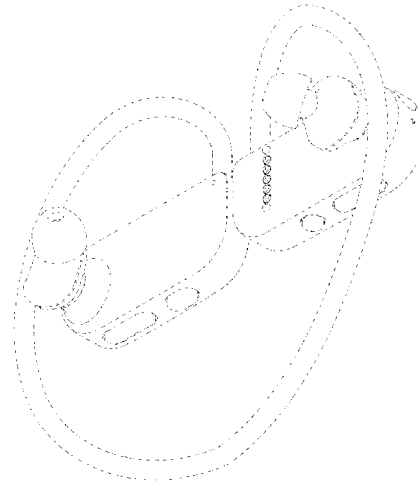
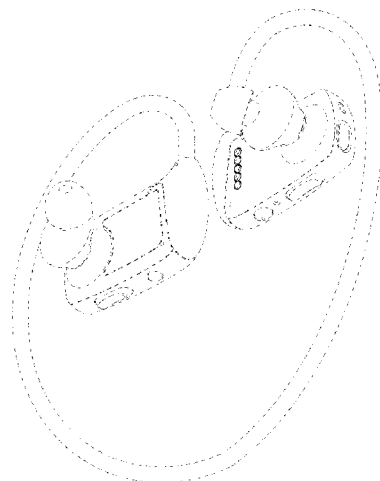

(56)

References Cited

U.S. PATENT DOCUMENTS

5,643,012 A 7/1997 Mai et al.
 5,824,966 A * 10/1998 Leight A61F 11/12
 181/130
 5,997,158 A * 12/1999 Fischer F21S 8/04
 362/364
 6,081,604 A * 6/2000 Hikichi H04R 1/083
 381/124
 6,082,485 A 7/2000 Smith
 D430,134 S 8/2000 Obata et al.
 6,138,790 A 10/2000 Leight
 6,385,325 B1 * 5/2002 Nageno H04R 5/0335
 381/370
 6,396,931 B1 5/2002 Malilay
 D484,485 S 12/2003 Matsuoka
 6,654,966 B2 12/2003 Rolla
 6,688,421 B2 2/2004 Dyer et al.
 6,728,388 B1 4/2004 Nageno et al.
 6,809,574 B1 * 10/2004 Kiani H03K 19/00315
 327/538
 D505,411 S 5/2005 Sakai
 6,922,476 B2 7/2005 Nassimi
 D512,992 S 12/2005 Murakami
 7,079,664 B2 7/2006 Nassimi
 7,110,535 B2 9/2006 Bodley et al.
 7,121,696 B2 * 10/2006 Whitfield, Sr. B05B 15/045
 362/147
 D538,268 S 3/2007 Gibson et al.
 D550,202 S 9/2007 Meier et al.
 D559,879 S 1/2008 Sumita

D559,880 S 1/2008 Sumita
 D566,104 S 4/2008 Suzuki
 D570,824 S 6/2008 Schultz et al.
 D574,029 S 7/2008 Yamagishi
 D587,678 S 3/2009 Yuyama
 D587,680 S 3/2009 Komiyama
 7,500,760 B2 * 3/2009 Byrne F21V 33/0092
 362/345
 D592,190 S 5/2009 Birger
 D601,548 S 10/2009 Morisawa
 D603,378 S 11/2009 Paradise
 D604,272 S 11/2009 Kitayama
 D604,722 S 11/2009 Mistry
 7,663,692 B2 * 2/2010 Chang H04N 5/2252
 348/372
 D619,539 S 7/2010 Komiyama
 7,811,101 B2 10/2010 Tang et al.
 D631,668 S * 2/2011 Limongi D4/133
 D635,547 S 4/2011 Komiyama
 D636,381 S 4/2011 Liner
 D637,176 S * 5/2011 Brunner D14/205
 D640,242 S 6/2011 Fahrendorff et al.
 8,080,757 B2 12/2011 Zuo
 8,252,445 B2 8/2012 Chu
 8,305,439 B2 * 11/2012 Cheng G08B 13/1963
 348/143
 D673,519 S 1/2013 Tan
 8,445,796 B2 5/2013 Yang et al.
 8,801,217 B2 * 8/2014 Oehle F21S 8/026
 362/235
 2013/0051012 A1 * 2/2013 Oehle F21S 8/026
 362/235

* cited by examiner

FIG.1

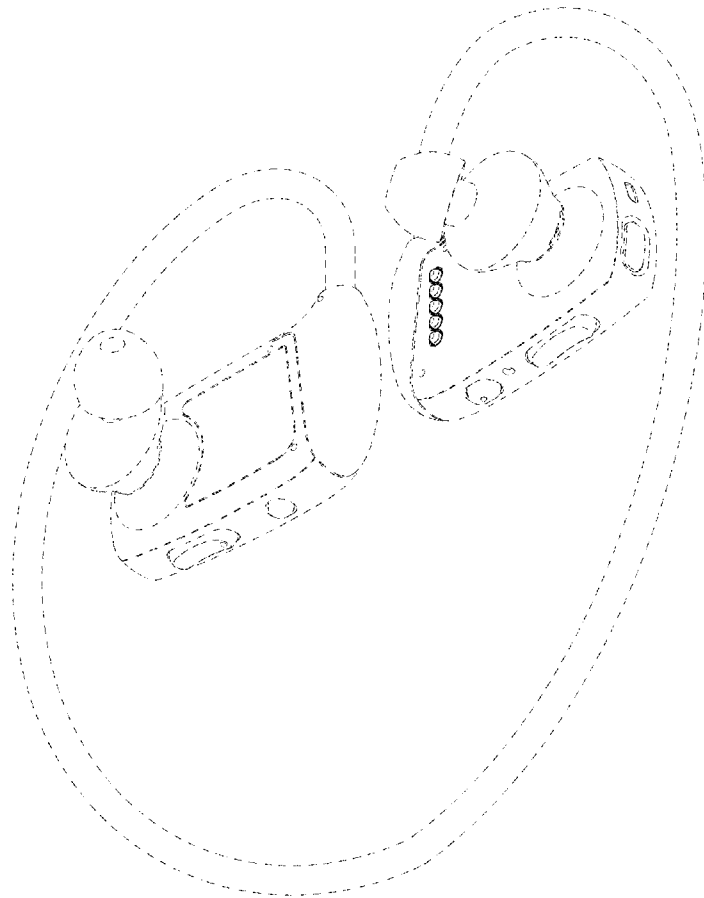

FIG.2

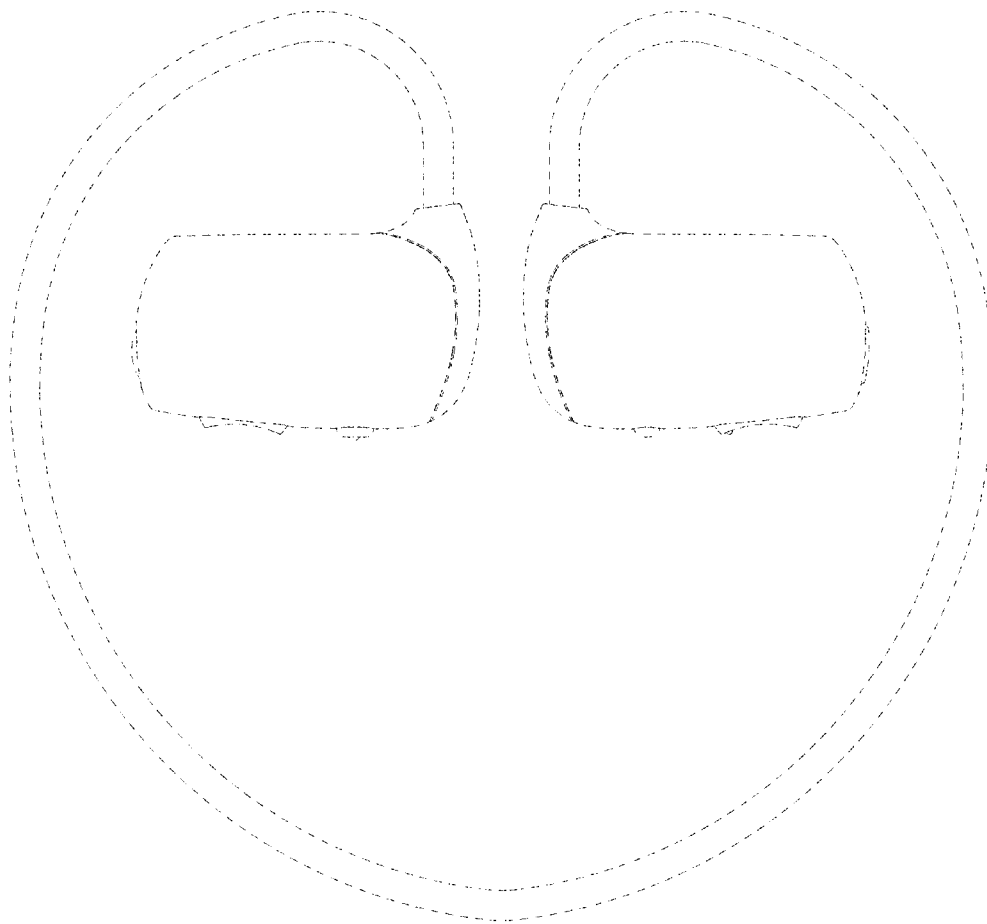

FIG.3

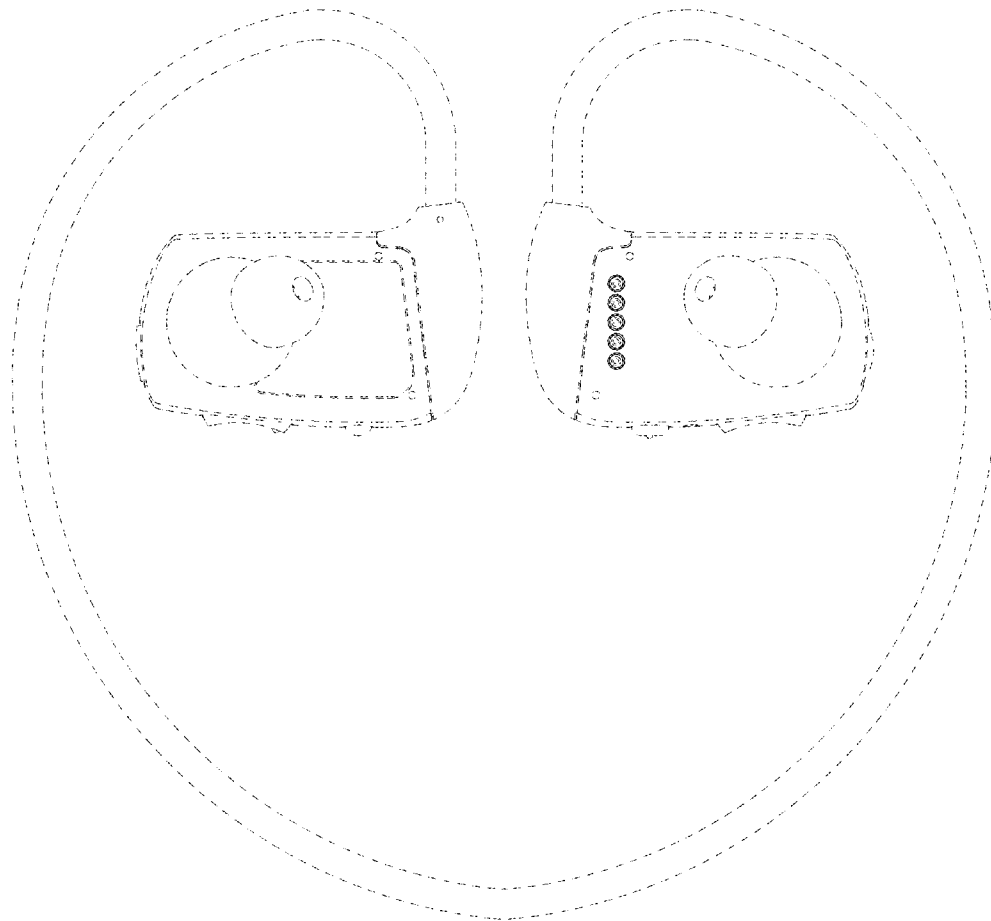

FIG.4

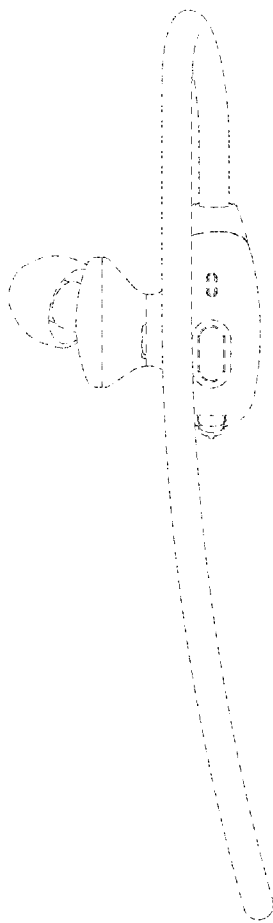

FIG.5

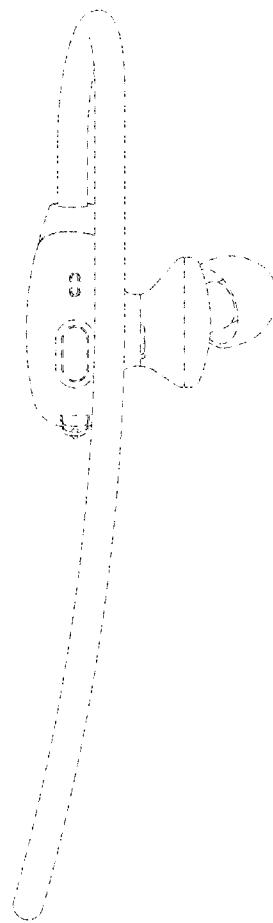

FIG.6

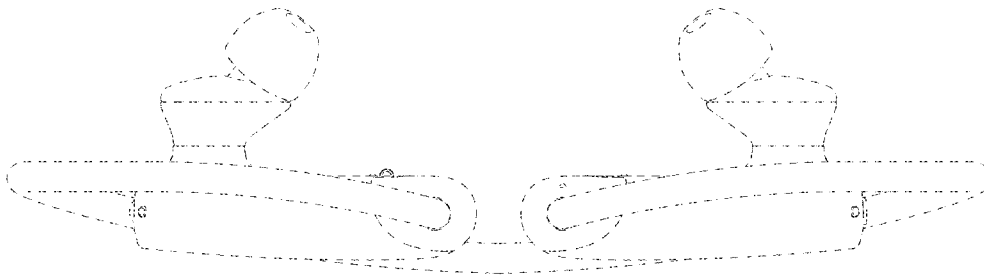

FIG.7

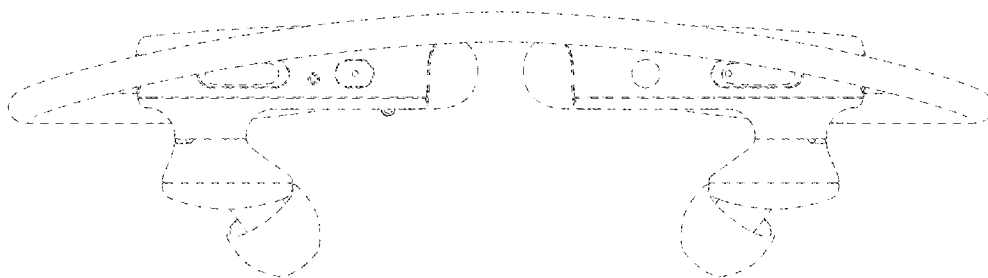

FIG.8

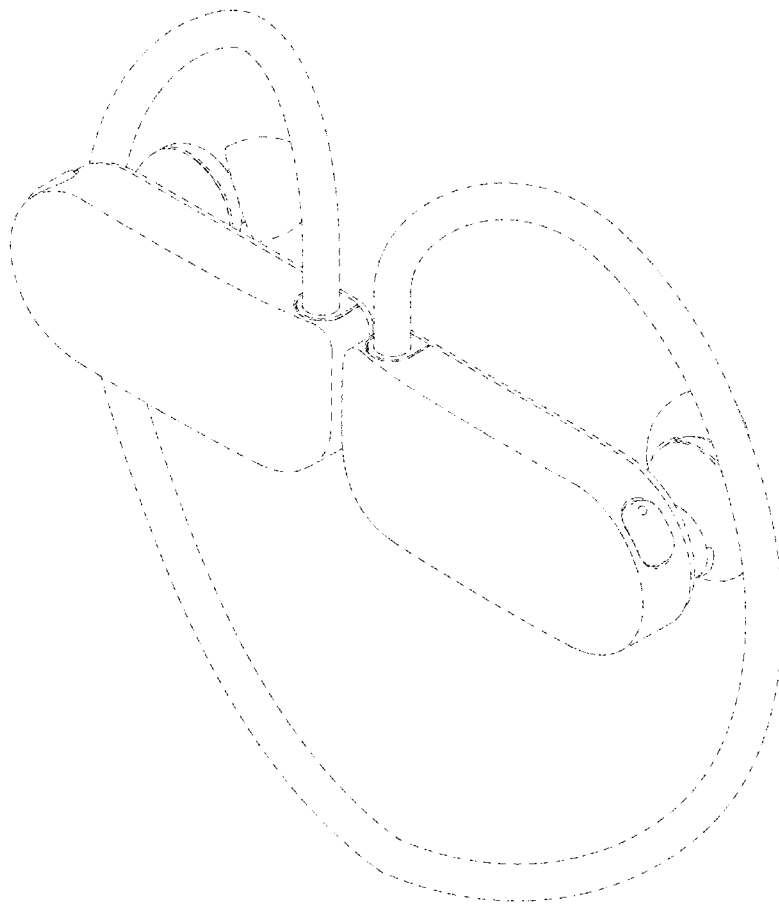

FIG.9

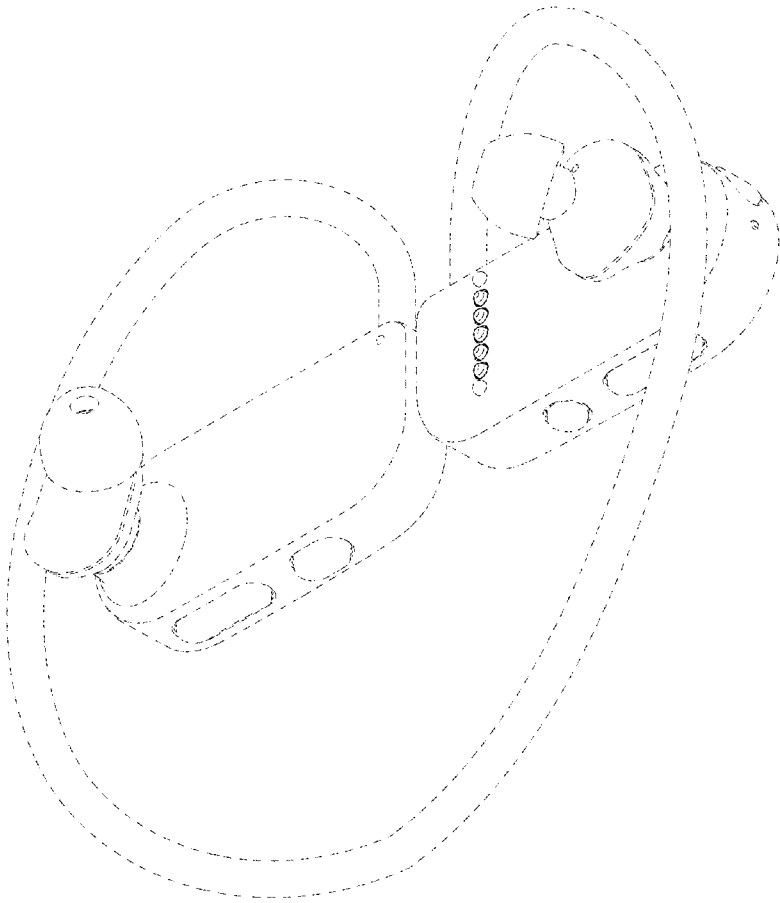

FIG.10

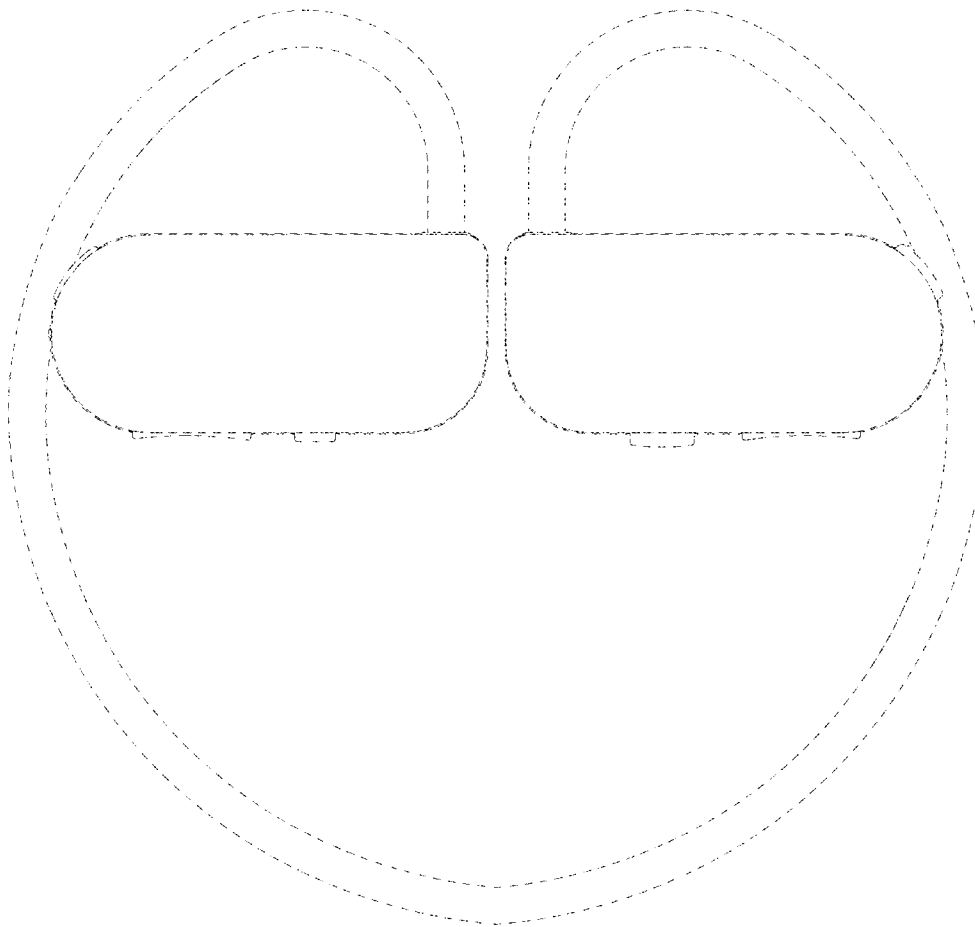

FIG.11

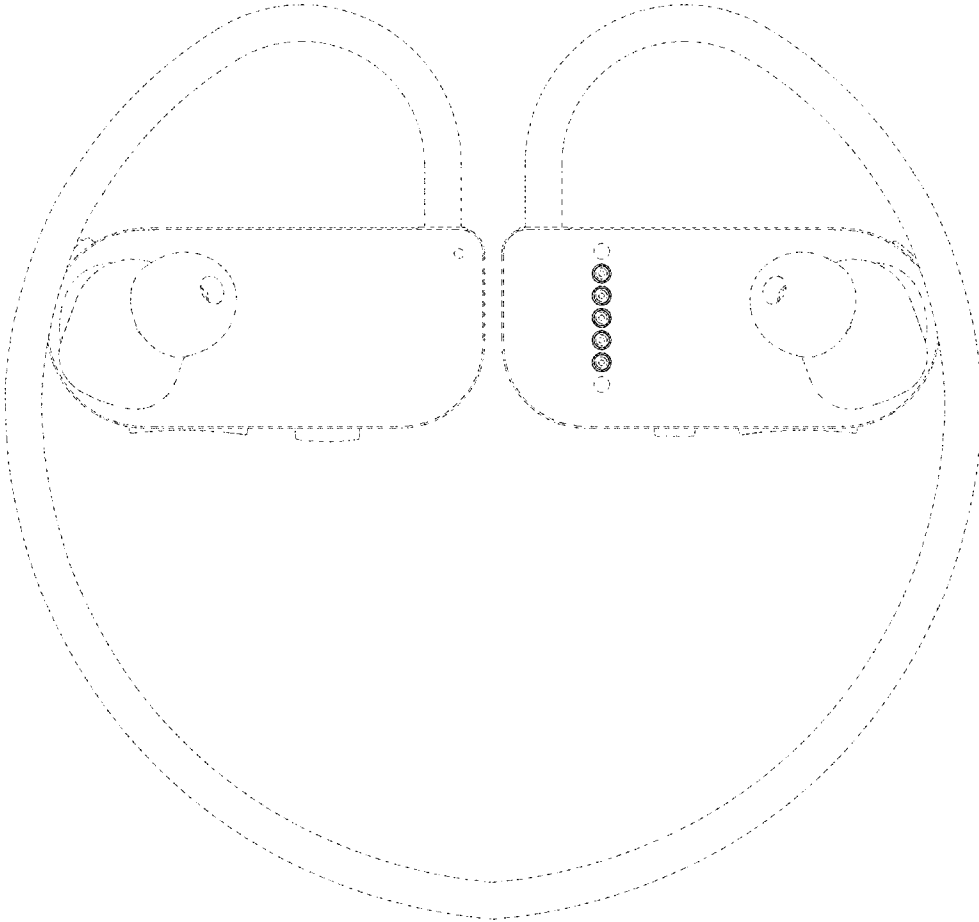

FIG.12

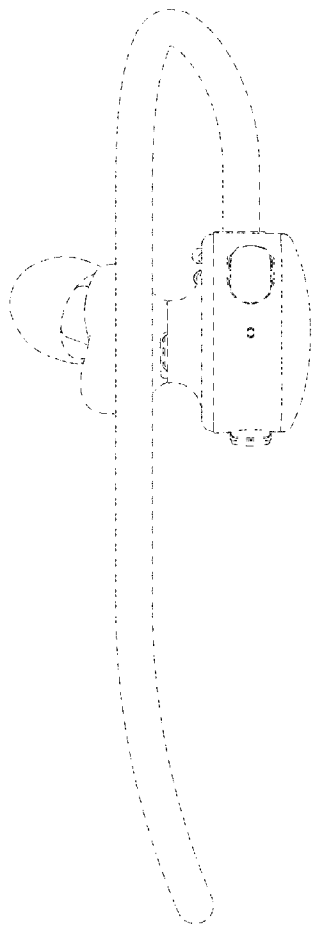

FIG.13

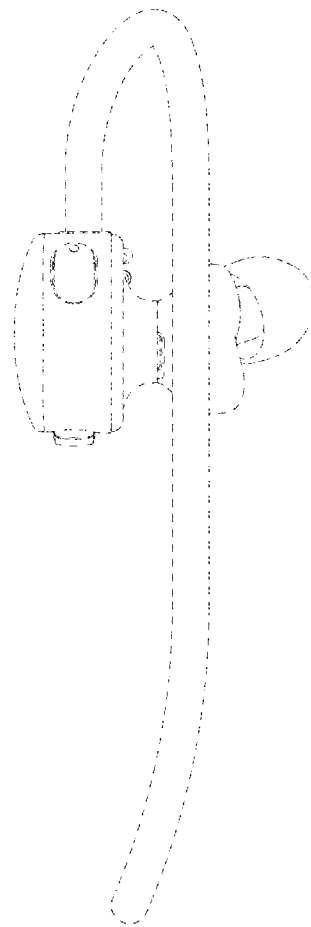

FIG.14

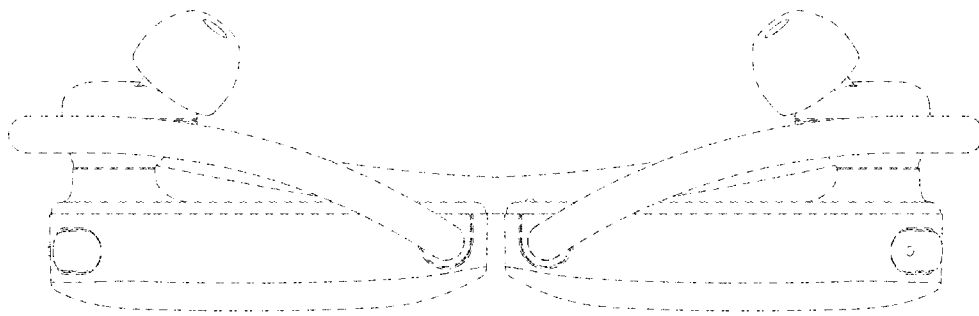

FIG.15

