



US00D793170S

(12) **United States Design Patent**
Karussi et al.

(10) **Patent No.:** **US D793,170 S**

(45) **Date of Patent:** **** Aug. 1, 2017**

(54) **BOWL WITH LID**

(74) *Attorney, Agent, or Firm* — Caesar Rivise, PC

(71) Applicant: **Tervis Tumbler Company**, North Venice, FL (US)

(57) **CLAIM**

The ornamental design for the bowl with lid, as shown and described.

(72) Inventors: **Kurt Karussi**, Osprey, FL (US); **Aaron Abroff**, Acton, MA (US); **Joongoo Lee**, Quincy, MA (US)

DESCRIPTION

(73) Assignee: **Tervis Tumbler Company**, North Venice, FL (US)

FIG. 1 is an isometric view of a bowl with lid in accordance with our new design;

(**) Term: **15 Years**

FIG. 2 is a front elevation view of the bowl with lid shown in FIG. 1;

(21) Appl. No.: **29/565,689**

FIG. 3 is a rear elevation view of the bowl with lid shown in FIG. 1;

(22) Filed: **May 24, 2016**

FIG. 4 is a right side elevation view of the bowl with lid shown in FIG. 1;

(51) **LOC (10) Cl.** **07-01**

FIG. 5 is a left side elevation view of the bowl with lid shown in FIG. 1;

(52) **U.S. Cl.**
USPC **D7/538**

FIG. 6 is a top plan view of the bowl with lid shown in FIG. 1;

(58) **Field of Classification Search**
USPC D7/500, 538, 505, 539, 543, 57, 581,
D7/629; D9/425, 424, 428; 220/810,
220/592.27

FIG. 7 is a bottom plan view of the bowl with lid shown in FIG. 1;

(Continued)

FIG. 8 is a somewhat enlarged cross sectional view taken along line 8-8 of FIG. 6, wherein the thin lined cross hatched portion of the lid designates that portion is opaque or translucent, whereas the alternating thin and thick lined cross hatched portion of the lid and the alternating thin and thick lined cross hatched portion of the bowl designates that those portions are transparent;

(56) **References Cited**

FIG. 9 is an isometric view of FIG. 1 shown with the lid removed;

U.S. PATENT DOCUMENTS

2,004,449 A * 6/1935 Stanley B65D 43/0212
206/819
D241,399 S * 9/1976 Christian D7/540

FIG. 10 is a front elevation view thereof;

(Continued)

FIG. 11 is a rear elevation view thereof;

FOREIGN PATENT DOCUMENTS

EP 0763483 A1 3/1997

FIG. 12 is a right side elevation view thereof;

OTHER PUBLICATIONS

Advertisement material entitled "Thermal Food Server"—<http://trade.indiamart.com>.

FIG. 13 is a left side elevation view thereof;

FIG. 14 is a top plan view thereof;

FIG. 15 is a bottom plan view thereof;

FIG. 16 is an isometric view of FIG. 1 shown with the bowl removed;

FIG. 17 is a side elevation view thereof, the side view being the same from any direction;

FIG. 18 is a top plan view thereof;

FIG. 19 is a bottom plan view thereof; and,
(Continued)

Primary Examiner — Cynthia Underwood

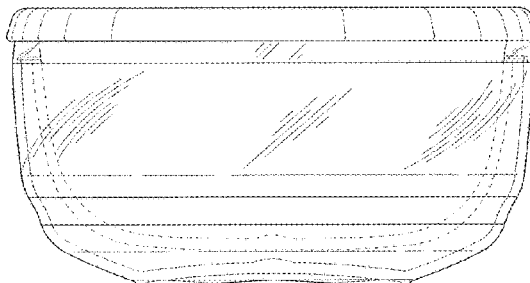
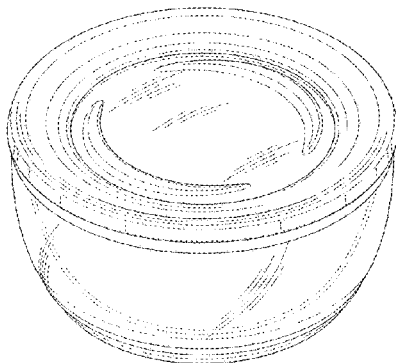

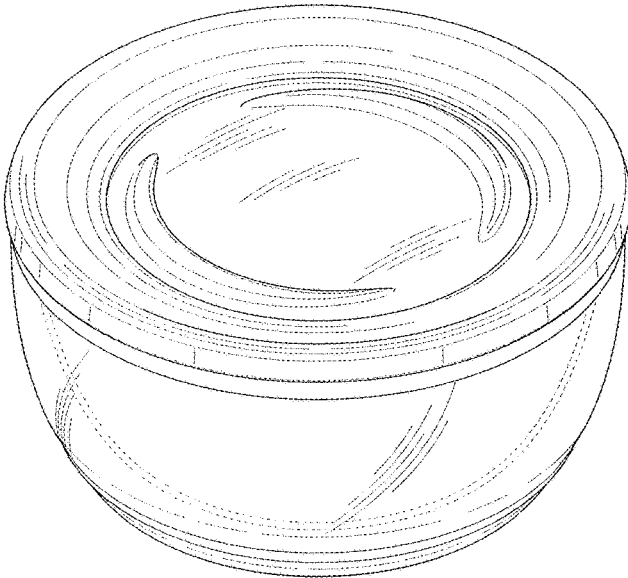

FIG. 1

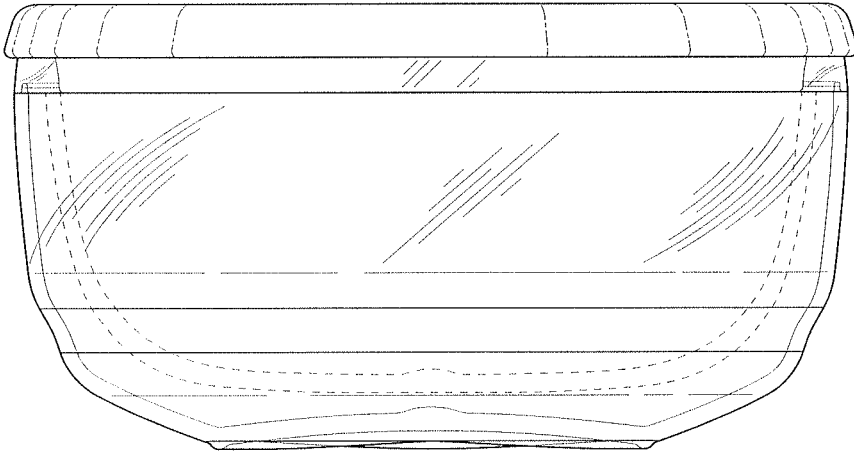

FIG. 2

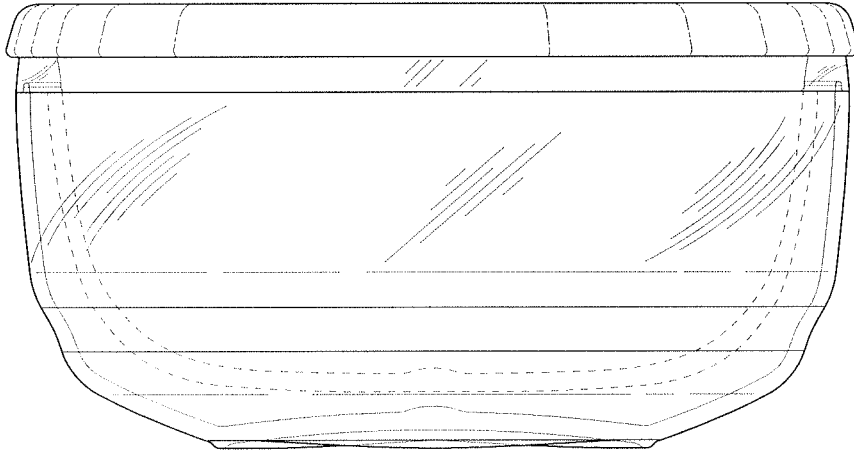

FIG. 3

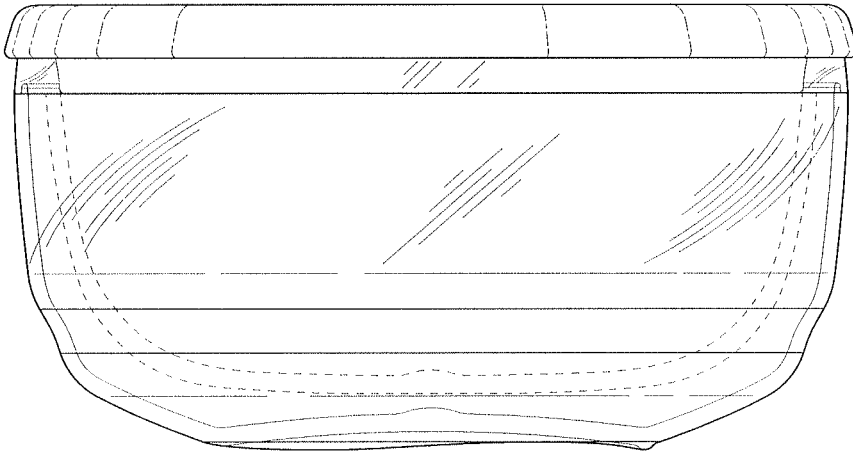

FIG. 4

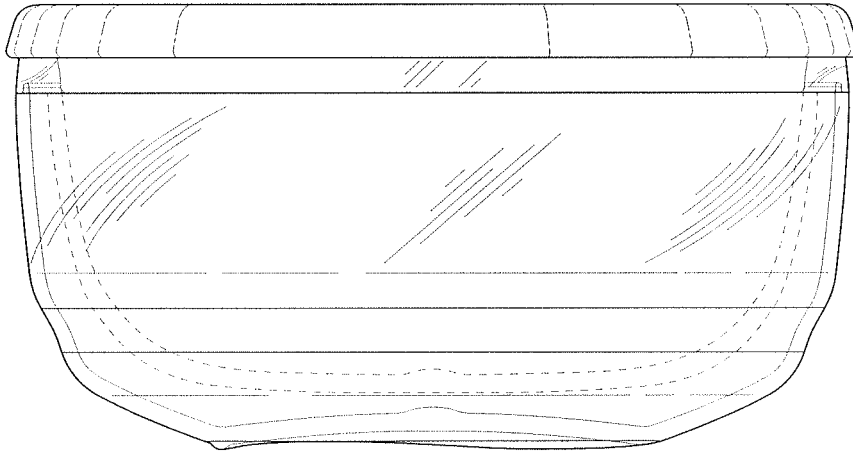

FIG. 5

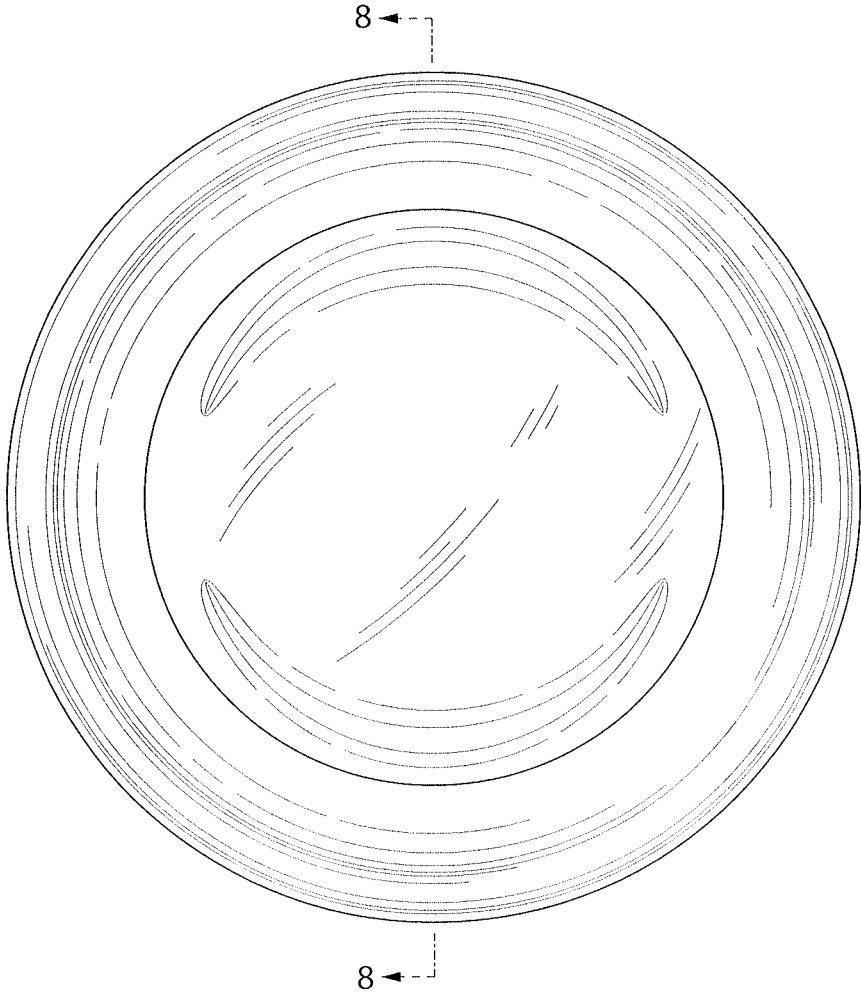

FIG. 6

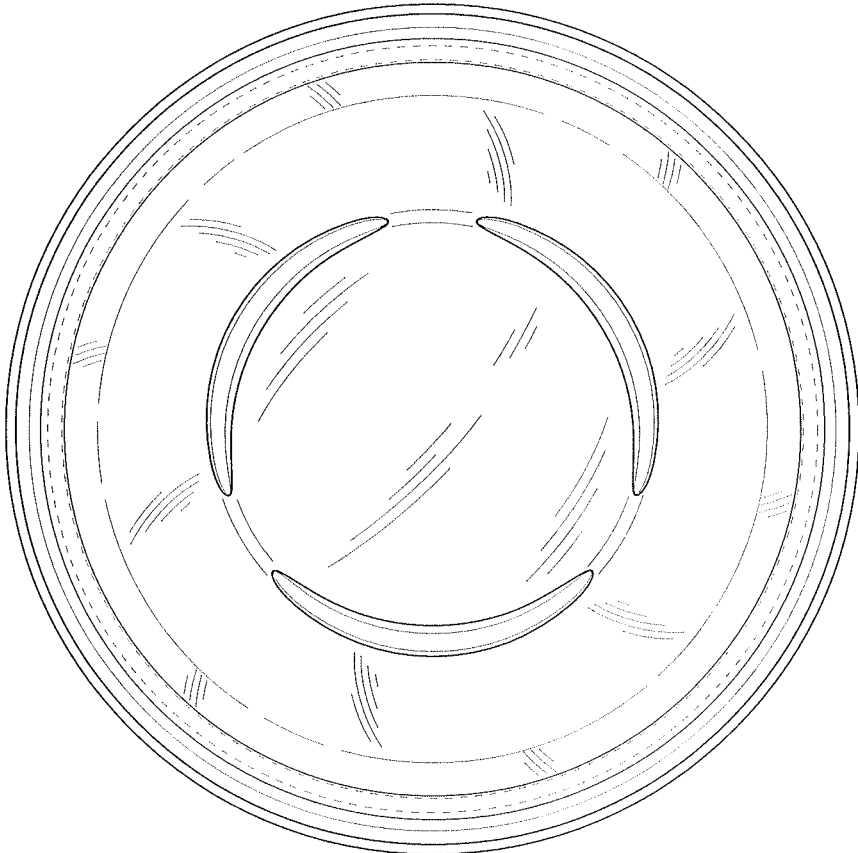

FIG. 7

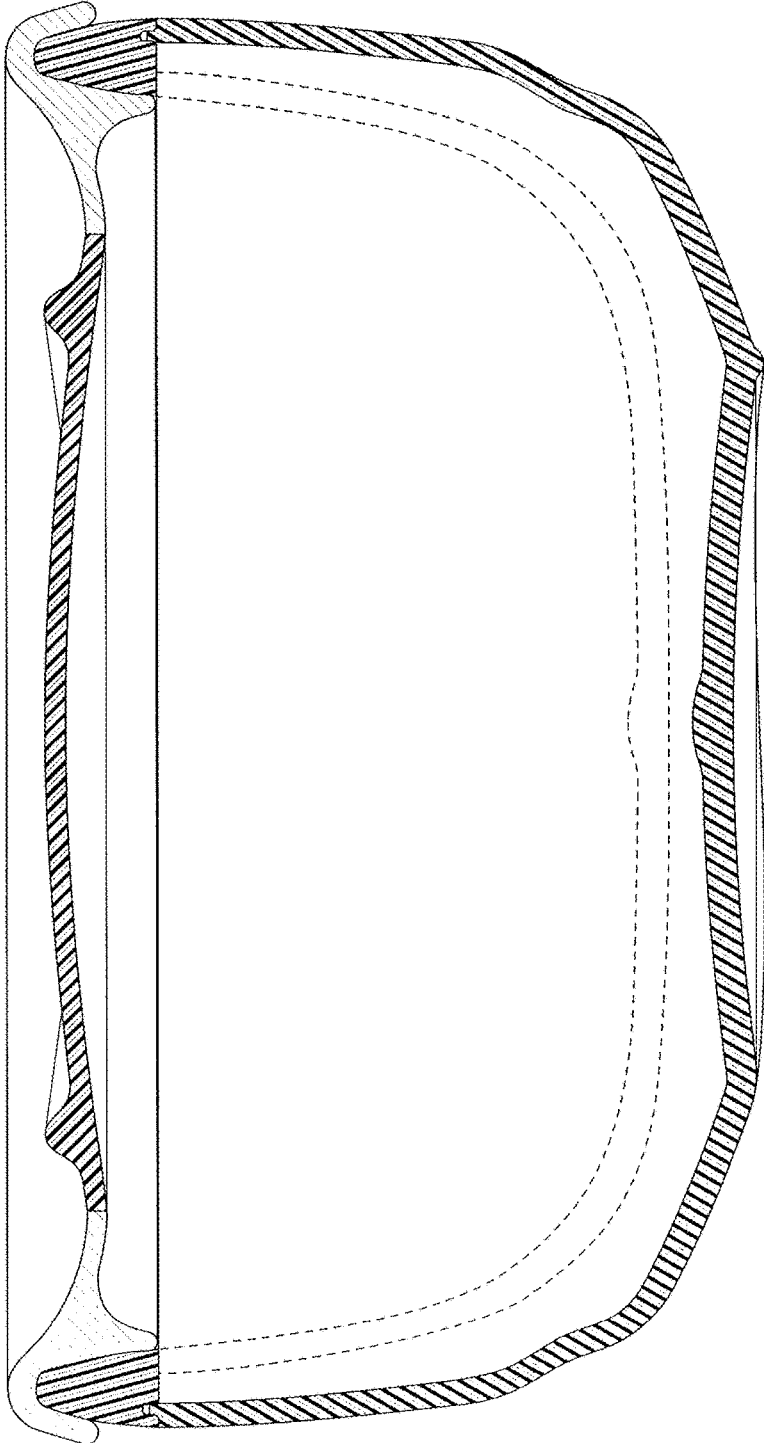

FIG. 8

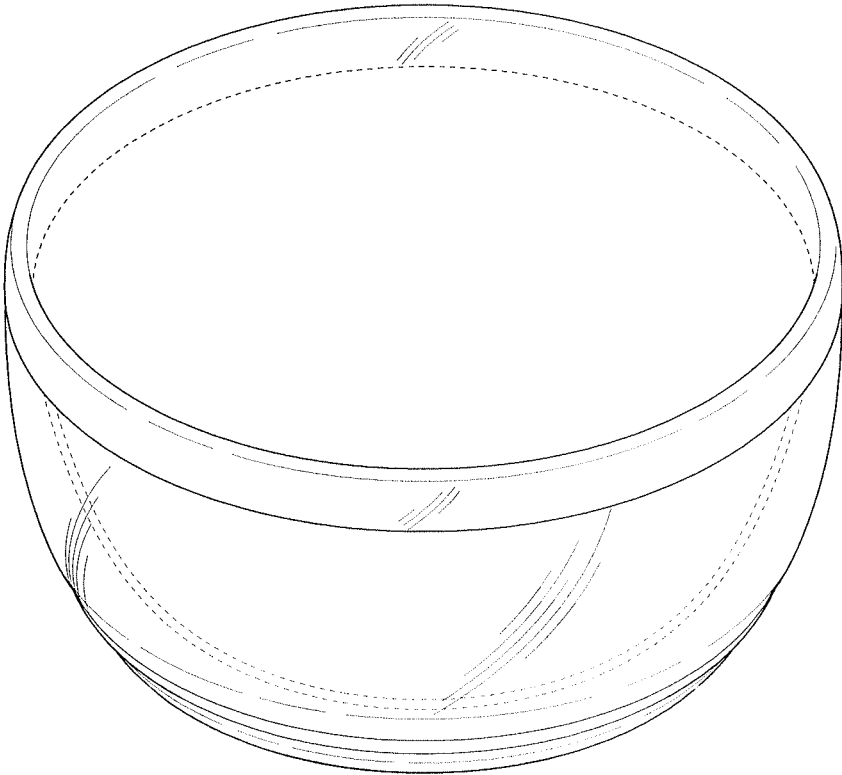

FIG. 9

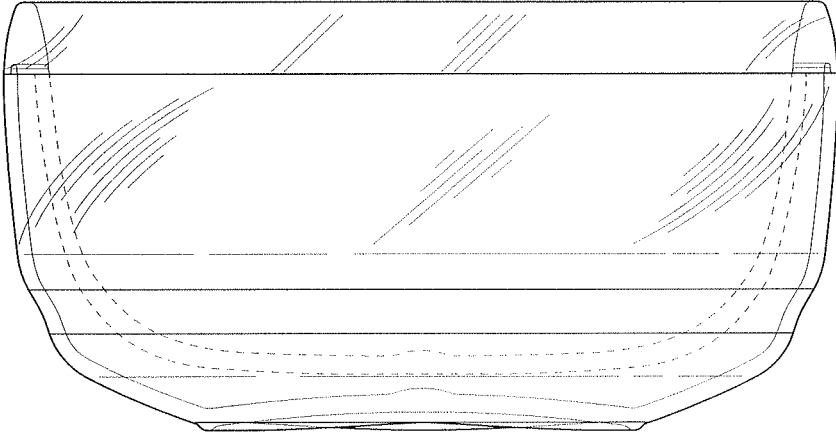

FIG. 10

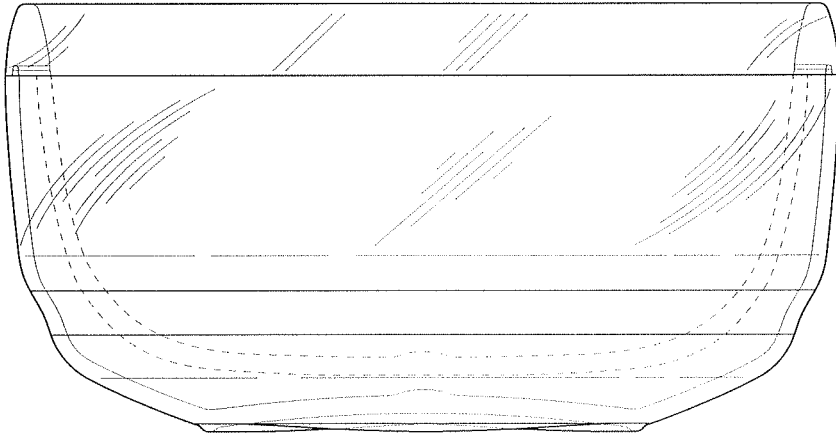

FIG. 11

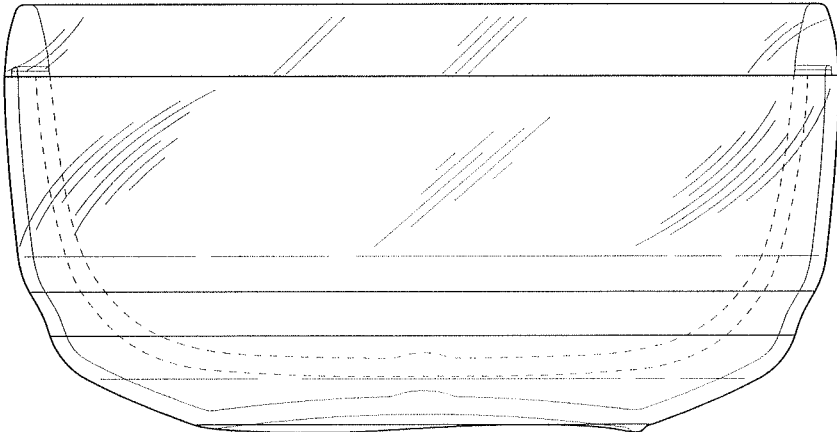

FIG. 12

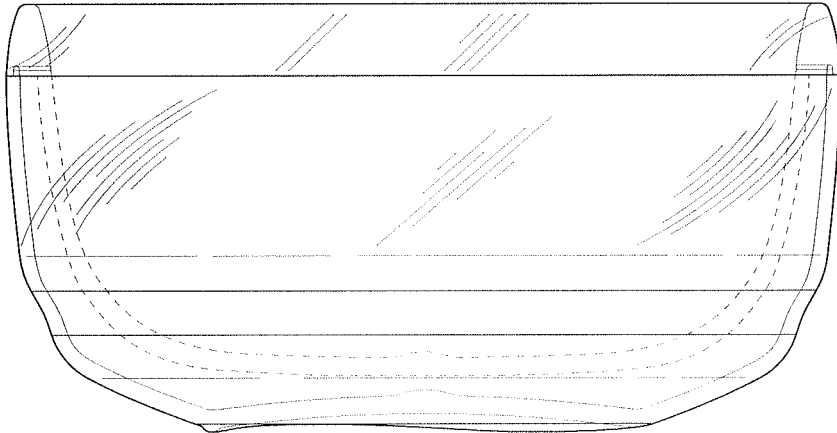

FIG. 13

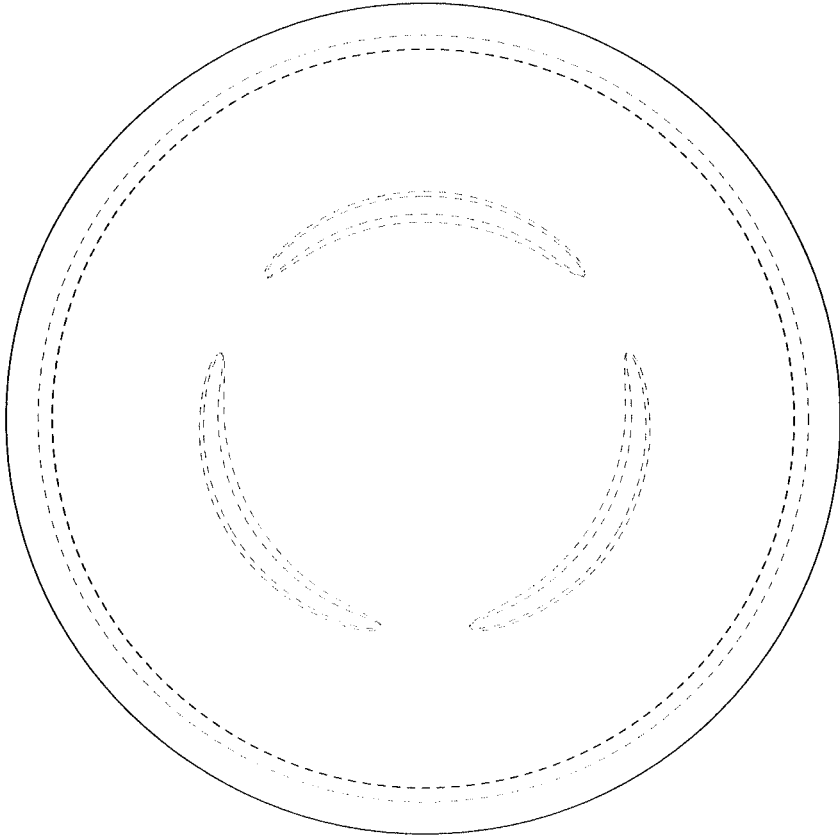

FIG. 14

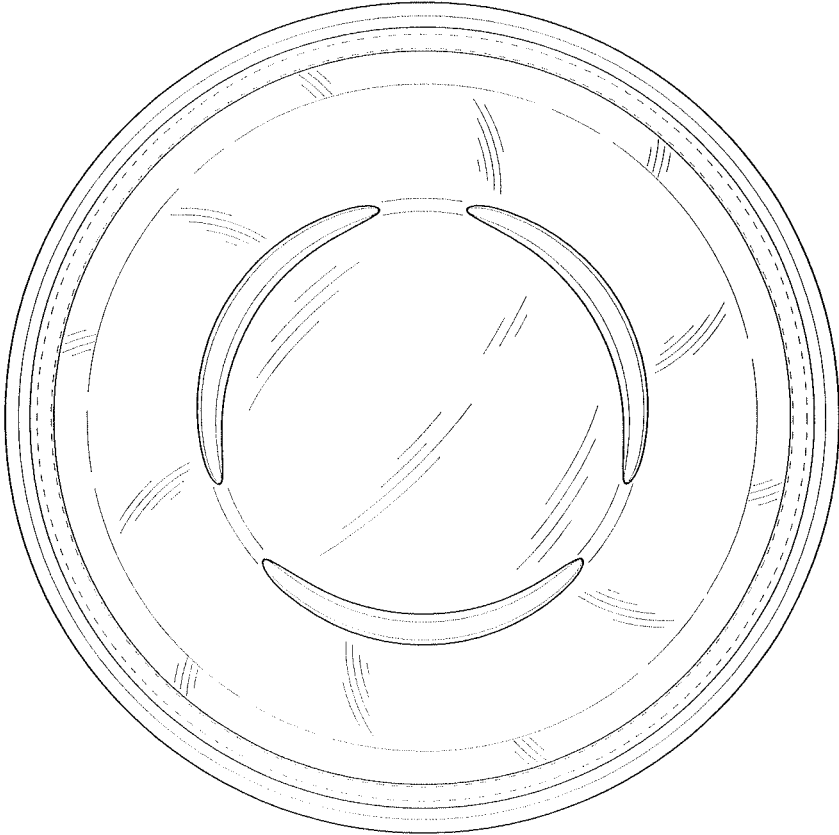

FIG. 15

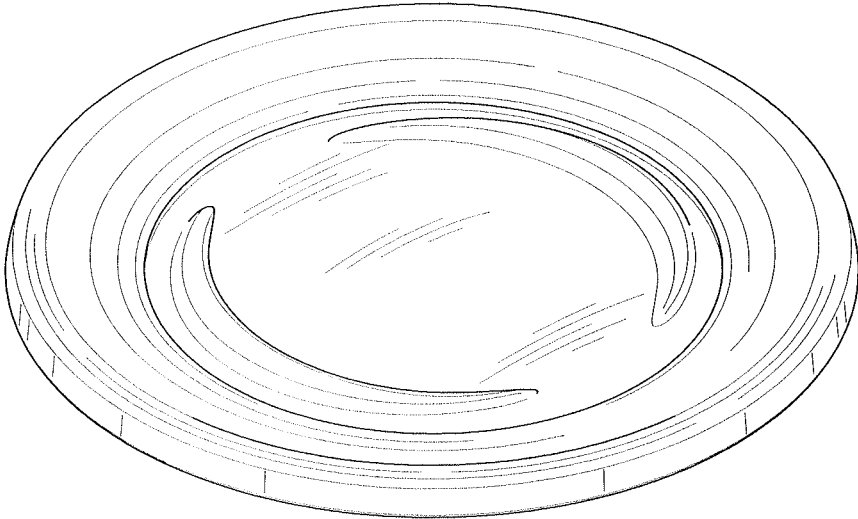

FIG. 16

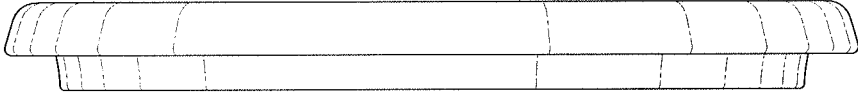

FIG. 17

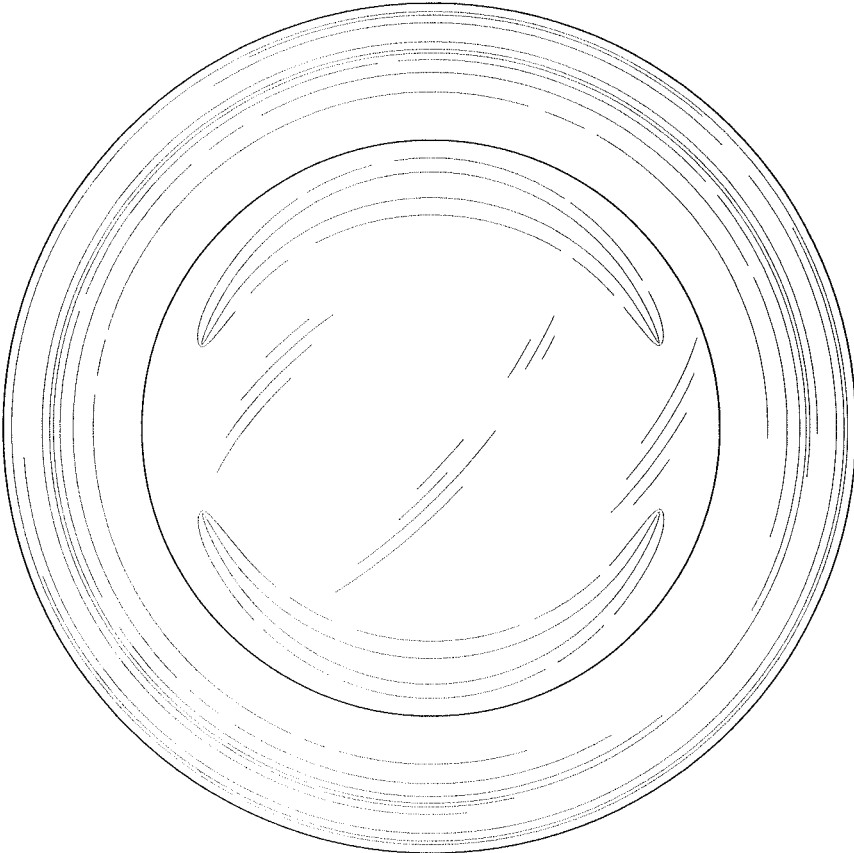

FIG. 18

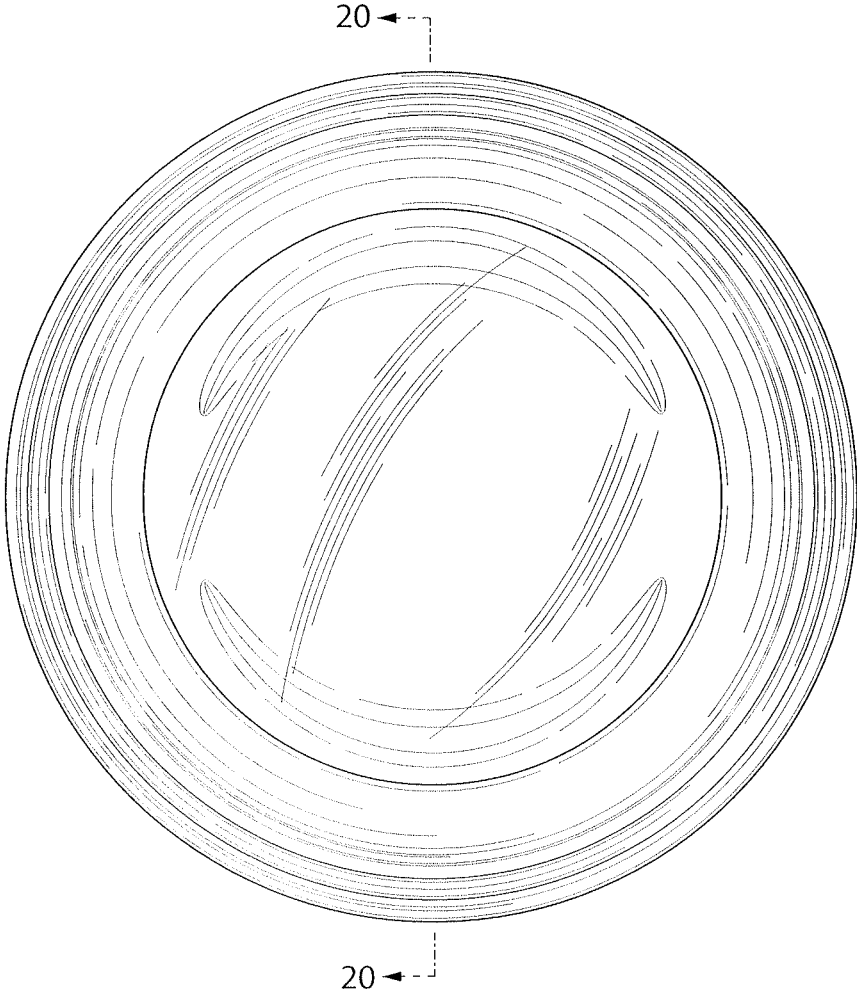

FIG. 19

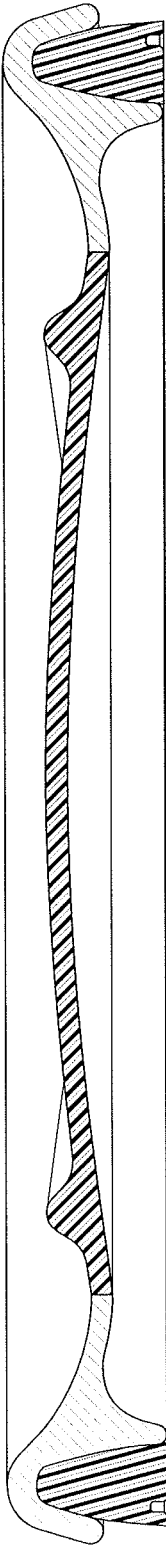

FIG. 20