



US00D686602S

(12) **United States Design Patent**
Nuovo et al.

(10) **Patent No.:** **US D686,602 S**

(45) **Date of Patent:** **** Jul. 23, 2013**

- (54) **HANDSET FRONT COVER**
- (71) Applicant: **Nokia Corporation**, Espoo (FI)
- (72) Inventors: **Frank Nuovo**, Los Angeles, CA (US);
Joel Bridge, Croydon (GB)
- (73) Assignee: **Vertu Corporation Limited**, Hampshire (GB)
- (**) Term: **14 Years**

D645,439	S	*	9/2011	Lee et al.	D14/138 AD
D647,083	S	*	10/2011	Nuovo et al.	D14/248
D648,698	S	*	11/2011	Suzuki	D14/138 G
D653,246	S	*	1/2012	Salazar et al.	D14/248
D654,465	S	*	2/2012	Salazar et al.	D14/138 G
D654,888	S	*	2/2012	Chung	D14/138 G
D657,765	S	*	4/2012	Salazar et al.	D14/138 G
D664,515	S	*	7/2012	Fagnot et al.	D14/138 G
D666,984	S	*	9/2012	Suzuki	D14/138 G
D670,261	S	*	11/2012	Nuovo et al.	D14/138 G
8,340,696	B2	*	12/2012	Endo et al.	455/460
D676,817	S	*	2/2013	Nuovo et al.	D14/138 G

- (21) Appl. No.: **29/433,715**
- (22) Filed: **Oct. 4, 2012**
- (51) **LOC (9) Cl.** **14-03**
- (52) **U.S. Cl.**
USPC **D14/248**
- (58) **Field of Classification Search**
USPC 455/575.1, 556.2, 575.3, 575.4; D21/517;
379/433.01, 433.04; D10/65, 78, 104; D13/168
See application file for complete search history.

OTHER PUBLICATIONS

Vertu Ti telephone, announced Feb. 2013, [online], [site visited Mar. 19, 2013]. Available from Internet, <URL: http://www.gsmarena.com/vertu_ti-5297.php>.*

(Continued)

Primary Examiner — Jeffrey D Asch
(74) *Attorney, Agent, or Firm* — Myers Wolin, LLC

(57) **CLAIM**
The ornamental design for a handset front cover, as shown and described.

(56) **References Cited**

U.S. PATENT DOCUMENTS

D465,483	S	*	11/2002	Nuovo	D14/248
D517,057	S	*	3/2006	Nuovo et al.	D14/248
D574,818	S	*	8/2008	Nuovo	D14/248
D590,802	S	*	4/2009	Shin et al.	D14/138 AD
D604,282	S	*	11/2009	Nuovo et al.	D14/247
D605,618	S	*	12/2009	Nuovo et al.	D14/138 AA
D611,921	S	*	3/2010	Bang et al.	D14/138 G
D615,519	S	*	5/2010	Kim et al.	D14/138 G
D624,046	S	*	9/2010	Lee et al.	D14/138 G
D631,025	S	*	1/2011	Yeh et al.	D14/138 G
D631,456	S	*	1/2011	Chung et al.	D14/138 G
D631,461	S	*	1/2011	Yuan	D14/138 G
D633,459	S	*	3/2011	Suzuki	D14/138 G
D634,312	S	*	3/2011	Dry et al.	D14/248
D635,562	S	*	4/2011	Fan et al.	D14/248

DESCRIPTION

FIG. 1 is a perspective view of a handset front cover showing our new design;
FIG. 2 is a front view thereof;
FIG. 3 is a rear view thereof;
FIG. 4 is a left side view thereof;
FIG. 5 is a right side view thereof;
FIG. 6 is a top view thereof; and,
FIG. 7 is a bottom view thereof.
The broken lines of the handset front cover and the unshaded regions therein are for illustrative purposes only and form no part of the claimed design.

1 Claim, 5 Drawing Sheets

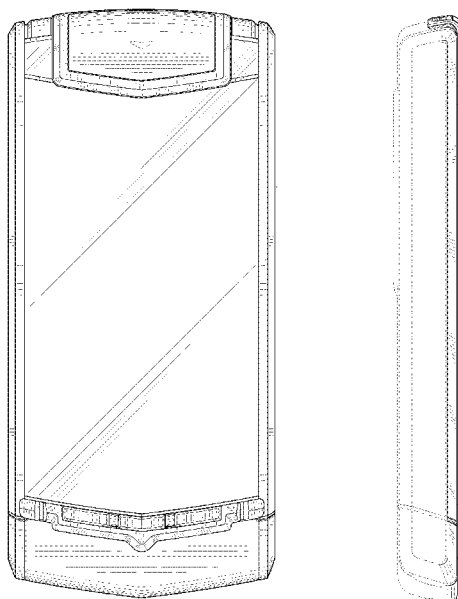

OTHER PUBLICATIONS

Vertu Constellation telephone, announced Oct. 2011, [online], [site visited Mar. 19, 2013]. Available from Internet, <URL: http://www.gsmarena.com/vertu_constellation-4263.php>.*

Samsung i8910 Omnia HD telephone, announced Feb. 2009, [online], [site visited Mar. 19, 2013]. Available from Internet, <URL: http://www.gsmarena.com/samsung_i8910_omnia_hd-2691.php>.*

Vertu Signature S telephone, announced Oct. 2008, [online], [site visited Mar. 19, 2013]. Available from Internet, <URL: http://www.gsmarena.com/vertu_signature_s-2753.php>.*

Celkon C77 telephone, announced 2011, [online], [site visited Mar. 19, 2013]. Available from Internet, <URL: http://www.gsmarena.com/celkon_c77-4489.php>.*

* cited by examiner

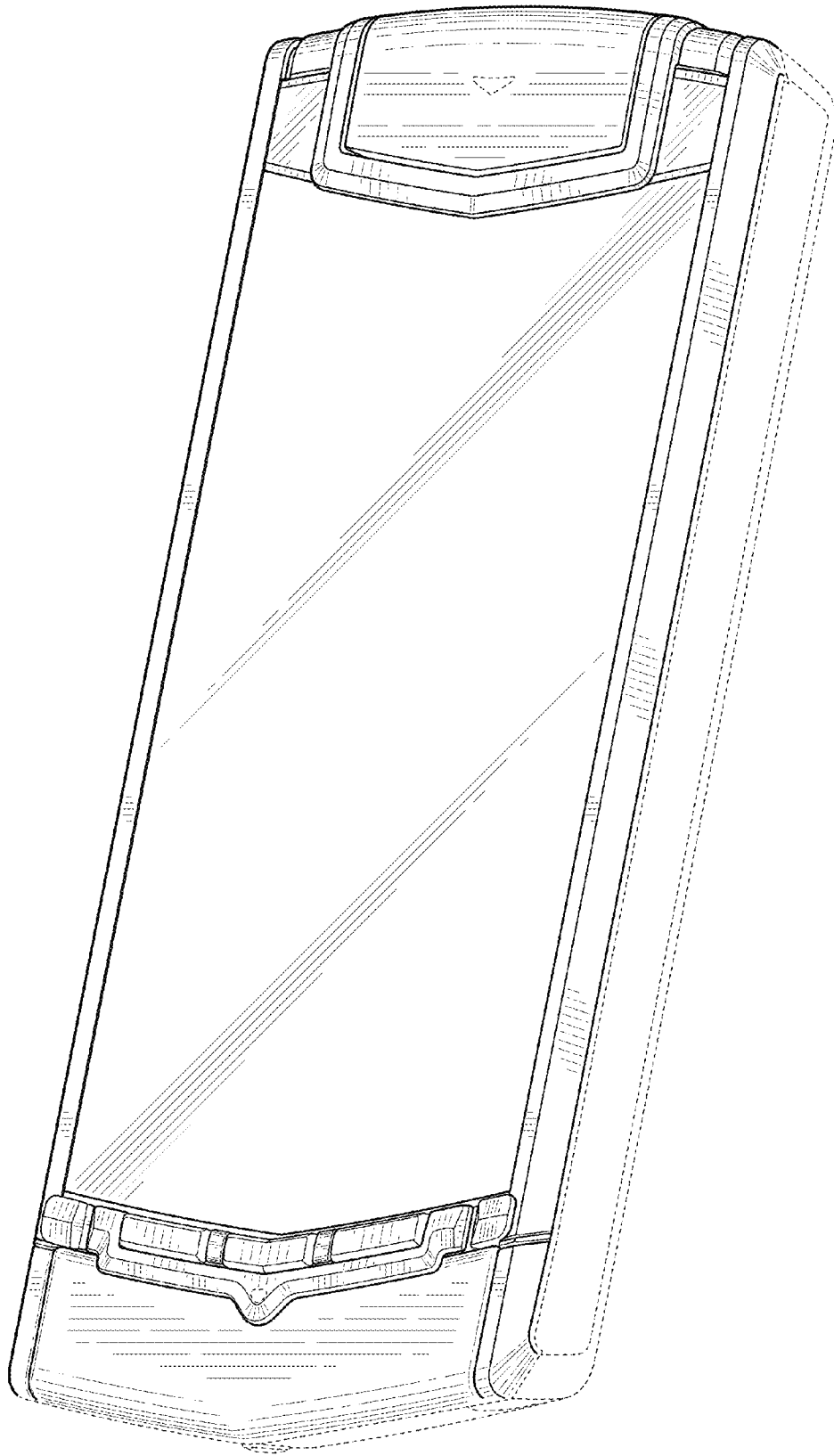

FIG. 1

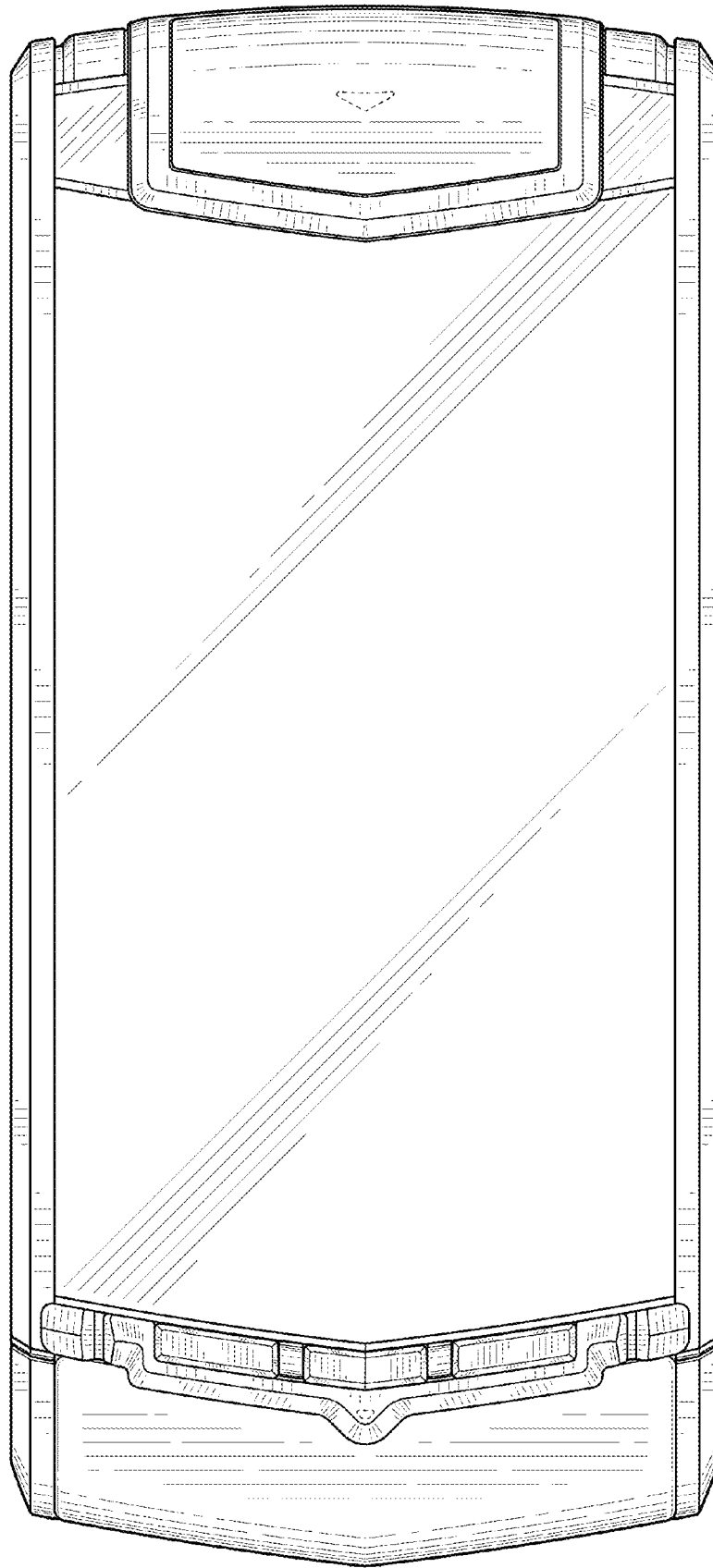

FIG. 2

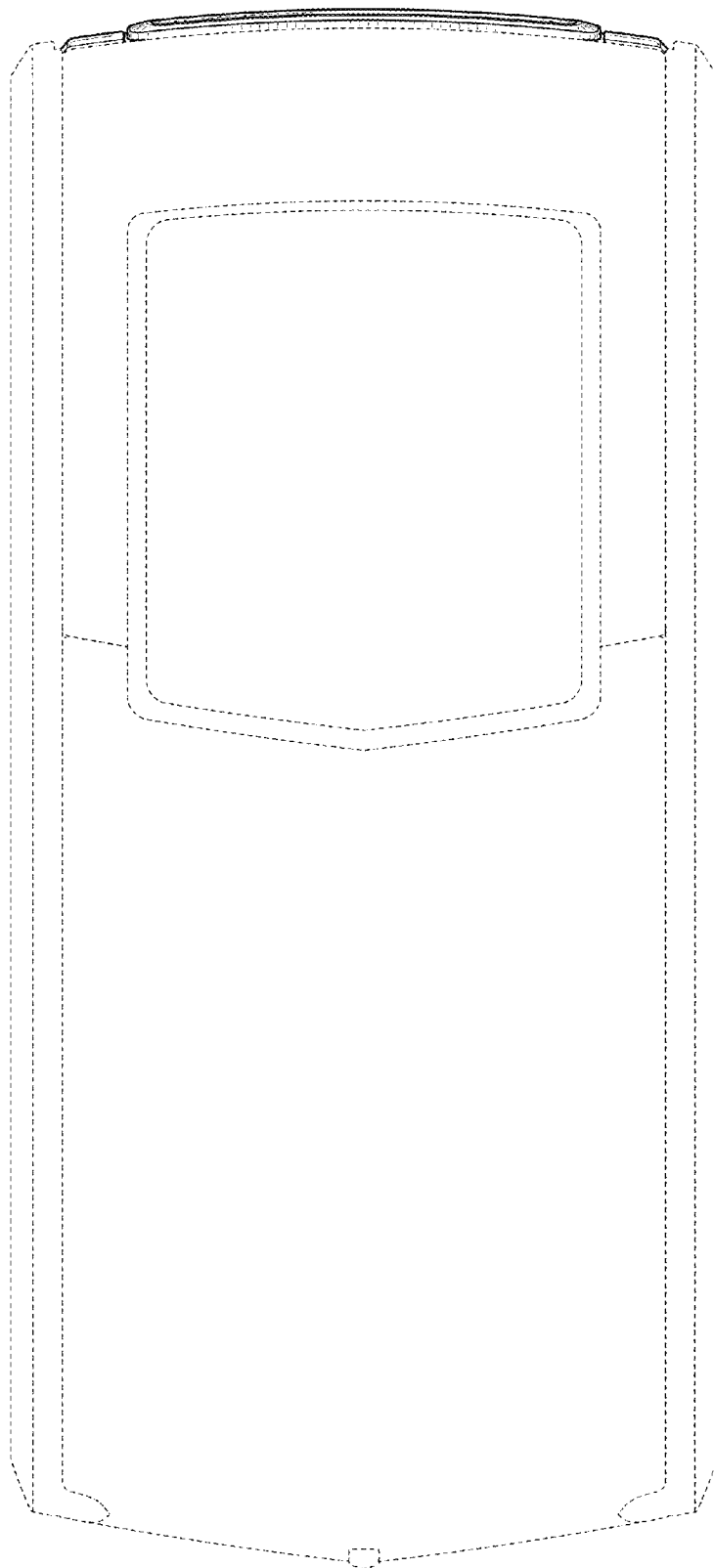

FIG. 3

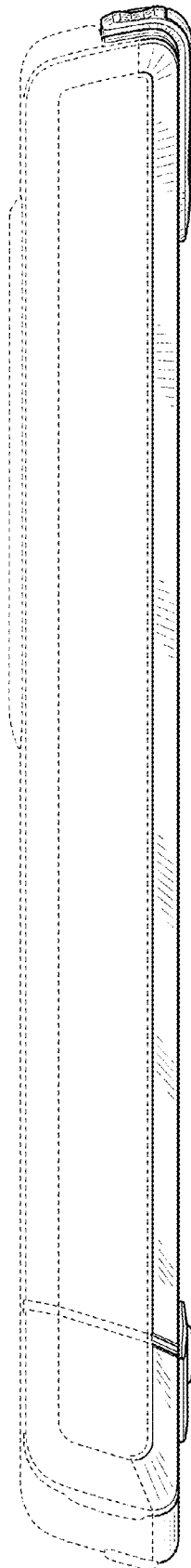

FIG. 4

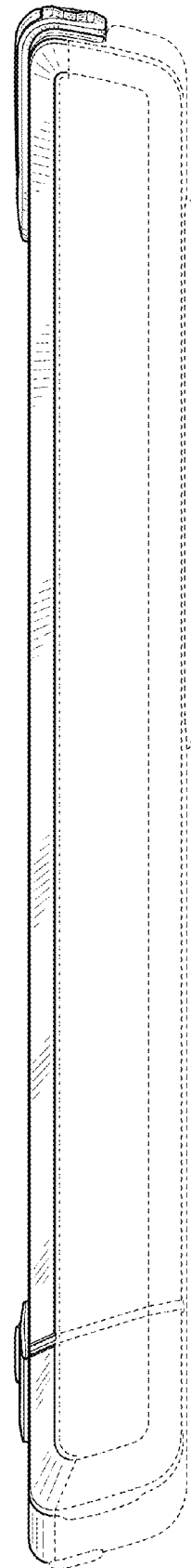

FIG. 5

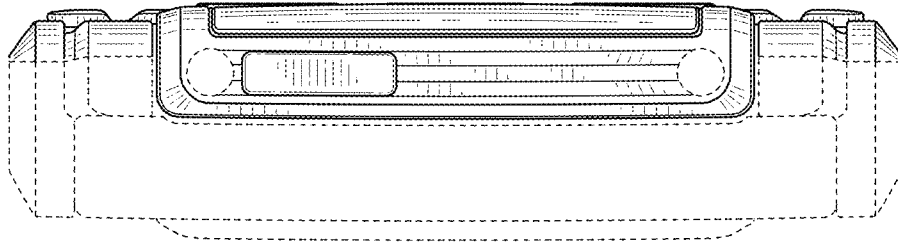

FIG. 6

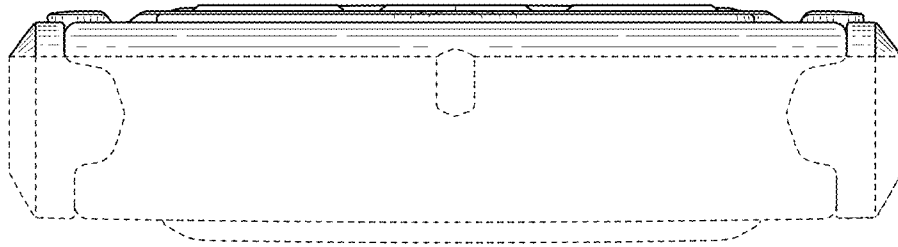

FIG. 7