

(19) World Intellectual Property Organization
International Bureau



(43) International Publication Date
13 February 2003 (13.02.2003)

PCT

(10) International Publication Number
WO 03/012722 A1

(51) International Patent Classification⁷: **G06K 5/00**

(21) International Application Number: PCT/US02/22805

(22) International Filing Date: 17 July 2002 (17.07.2002)

(25) Filing Language: English

(26) Publication Language: English

(30) Priority Data:
60/305,605 17 July 2001 (17.07.2001) US

(71) Applicant and

(72) Inventor: **NOHR, Steven, P.** [US/US]; 20034-95th Place
N.E., Bothell, WA 98011 (US).

(74) Agents: **BOZZO, Frank, J.** et al.; Dorsey & Whitney LLP,
1420 Fifth Avenue, Suite 3400, Seattle, WA 98101 (US).

(81) Designated States (national): AE, AG, AL, AM, AT, AU,
AZ, BA, BB, BG, BR, BY, BZ, CA, CH, CN, CO, CR, CU,

CZ, DE, DK, DM, DZ, EC, EE, ES, FI, GB, GD, GE, GH,
GM, HR, HU, ID, IL, IN, IS, JP, KE, KG, KP, KR, KZ, LC,
LK, LR, LS, LT, LU, LV, MA, MD, MG, MK, MN, MW,
MX, MZ, NO, NZ, OM, PH, PL, PT, RO, RU, SD, SE, SG,
SI, SK, SL, TJ, TM, TN, TR, TT, TZ, UA, UG, US, UZ,
VN, YU, ZA, ZM, ZW.

(84) Designated States (regional): ARIPO patent (GH, GM,
KE, LS, MW, MZ, SD, SL, SZ, TZ, UG, ZM, ZW),
Eurasian patent (AM, AZ, BY, KG, KZ, MD, RU, TJ, TM),
European patent (AT, BE, BG, CH, CY, CZ, DE, DK, EE,
ES, FI, FR, GB, GR, IE, IT, LU, MC, NL, PT, SE, SK,
TR), OAPI patent (BF, BJ, CF, CG, CI, CM, GA, GN, GQ,
GW, ML, MR, NE, SN, TD, TG).

Published:
— with international search report

For two-letter codes and other abbreviations, refer to the "Guidance Notes on Codes and Abbreviations" appearing at the beginning of each regular issue of the PCT Gazette.

(54) Title: SYSTEM AND METHOD FOR CONTENT DELIVERY

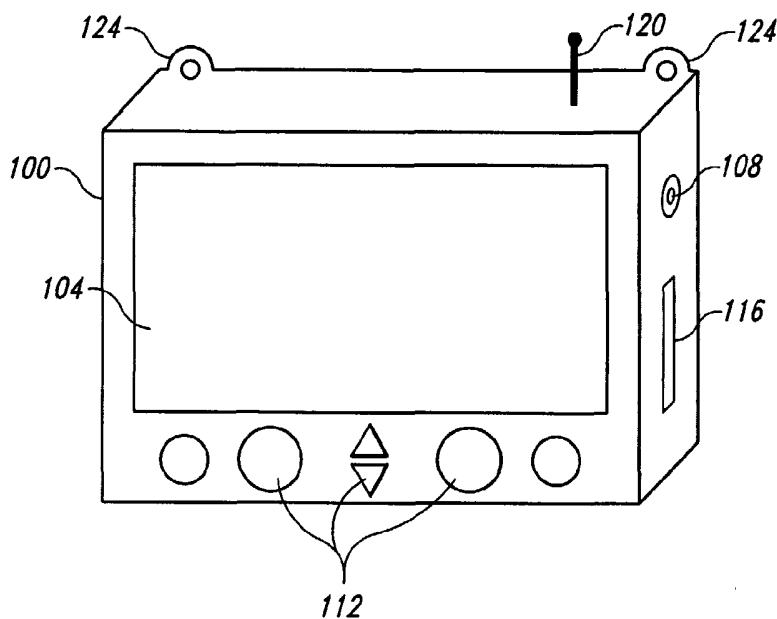

(57) Abstract: A content delivery system and method provides relevant information to users about items of interest to them. The user carries a device (100) storing database of information about a venue of interest. A network of identifier tags each are associated with objects or points of interest in that venue. A sensing mechanism (120) in the user's device polls for the presence of the identifier tags in a predetermined range of proximity, and upon finding such tags, the personal information terminal displays information (104) about the object or point of interest.



WO 03/012722 A1

SYSTEM AND METHOD FOR CONTENT DELIVERY

CROSS-REFERENCE TO RELATED APPLICATION

This application claims priority from United States Provisional Application
5 No. 60/305,605, filed July 17, 2001.

TECHNICAL FIELD

The present invention relates to electronically and automatically distributing
information of interest to individuals moving through a venue.

10

BACKGROUND OF THE INVENTION

In today's society, people are inundated with information from the media
and from advertisers. The problem is not that people do not want information; the problem
is that people would like information about what is relevant to them, and to obtain it in a
15 timely fashion and without an undue struggle. Similarly, one of the struggles of the media
and advertisers is to ferret out and reach those people that might be interested in their
messages. The problem, for both the would-be recipients and the would-be providers, is
one of relevance.

The case of people strolling through museums, tourist destinations, shopping
20 venues, and entertainment districts provide a good illustration of this phenomenon. Taking
the example of tourists in a museum, consider an English-speaking tourist in one of the
great museums of Italy. The tourist wants to view the paintings and sculptures in the
museum, and would like to learn a bit about the work and the artists that created them. She
can try to find a guidebook, but she has to find a guidebook for that museum's collection,
25 and has been written in or translated into English. Then, for the book to be helpful, as she
comes to each piece of interest, she has to find the name of the work, flip through the index
or the table of contents of her guidebook, turn to the appropriate section, and read the
material at that location. Unfortunately, that is a lot of work to do in a book when one went
to the museum with the intention to look at the art and not to look at guidebooks.

An alternative to the guidebook are pre-recorded walking tours that can be borrowed or rented which tell the user about the works they will see and the artists who created. These tapes share the same initial problem as the guidebooks: the would-be user must find one recorded in English. If one is available, the problem becomes that one must see the museum in the order and at the pace of the pre-recorded tour, and these pre-recorded tours offer no visual content. The user has traded the burden of needing to dig through a guidebook in exchange for sacrificing the freedom to tour the museum at her own piece. Certainly, both solutions leave much to be desired.

In the shopping and entertainment realms, stores, restaurants and clubs hand out coupons and leaflets on street corners, or pin them under car windshield wipers to try to attract business. Unfortunately, the distributors of these coupons and leaflets have no idea whether they are reaching their desired demographic group. The distributors of the coupons and leaflets can place themselves in an appropriate geographic location to advertise to people in the vicinity of the business for which they are advertising, but there is no way to tell how many – if any – of the persons they solicit are interested in the business they promote. This form of advertising may prove to be highly cost-ineffective.

In these tourist and consumer contexts, what is needed is a way to help those people interested in a particular type of information to get it, and when they want or need it, preferably while allowing them to suppress other information in which they are not interested. Similarly, merchants and advertisers need a way to better direct their advertising dollars and to attract more people interested in the goods and services with which they work.

It is to these objects that the present application is directed.

25 SUMMARY OF THE INVENTION

Embodiments of the present invention relate generally to the delivery of information to an interested audience.

One variation of the present invention employs a personal information terminal storing a database of information about a venue of interest, such as a museum,

tourist attraction, merchandising and entertainment venues, and a network of identifier tags associated with objects or points of interest, such as artworks, landmarks, or objects for sale. Information is programmed into the personal information terminal that is responsive to each of the identifier tags. The personal information terminal uses a sensing mechanism to poll for the presence of one or more identifier tags. Upon detecting an identifier tag in a predetermined range of proximity, the personal information terminal makes available to the user from its database information about the object or point of interest with which the detected identifier tag is associated, or otherwise accesses the information from a local content delivery device. In other variations, a central content delivery device may monitor the position of a user by a user tag relative to an identifier tag and transmit content when appropriate, or the content delivery device may transmit content to all users detected within a certain proximity.

Users have control over the content they receive. A user can specify what types of objects or points of interest in which he is interested, and can indicate his preferences for whether the information is provided on a display in text form, is read audibly, or both, and can select specific attributes such as language, voice, type of content, size, and other parameters. Also, a user can change his preferences, stop presentation of content in which he decides he is not interested, he can review the content, and he can save the content onto a media storage device which he can take as a souvenir for future review. The personal information terminal also can track a user's activities and that information can later be captured and studied by managers of the venue.

Another variation of the present invention employs a similar personal information terminal, but instead of delivering content from a stored database, the personal information terminal receives information from a content delivery device within a predetermined proximity. By contrast with the first variation of the present invention, in which the content delivery system reacted to the presence of passive identifier tag devices, this content delivery process is more active in nature. When the content delivery system comes within the requisite proximity of a content delivery device and the content delivery device detects the content delivery system's polling signal, the content delivery device

sends a response. The response queries the personal information terminal to determine, based on preferences indicated by the user of the personal information terminal, if the user is a potentially interested recipient of content. If so, the content delivery device sends a relevant message to the personal information terminal. As with the first variation, the user
5 can choose to receive the content, stop the content, save the content, etc. The content received by the user can be saved by the user at a remote site where it can be later retrieved. In addition, information distributors can track the actions of a user for later use.

BRIEF DESCRIPTION OF THE DRAWINGS

10 Figure 1A is a front perspective view of a personal information terminal of a first embodiment of the present invention.

Figure 1B is a rear perspective view of a personal information terminal of a first embodiment of the present invention.

Figure 2 is an identifier tag of a first embodiment of the present invention.

15 Figure 3 is a block diagram of the personal information terminal of a first embodiment of the present invention shown in Figure 1.

Figure 4 is a diagram depicting users of personal information terminals in a venue where identifier tags are arrayed of a first embodiment of the present invention .

20 Figure 5 is a flowchart depicting the general operation of the personal information terminal potentially coming within proximity of an identifier tag of a first embodiment of the present invention.

Figure 6 is a block diagram of the personal information terminal of a second embodiment of the present invention.

25 Figure 7A is a perspective view of a content delivery device of the second embodiment of the present invention.

Figure 7B is a perspective view of another form of content delivery device of the second embodiment of the present invention.

Figure 8 is a block diagram of the content delivery device of a second embodiment of the present invention.

Figure 9 is a flowchart depicting the general operation of the personal information terminal potentially coming within proximity of a content delivery device under the second embodiment of the present invention.

5 DETAILED DESCRIPTION OF THE INVENTION

Embodiments of the present invention are directed to providing portable electronic devices with automatic distribution of content based on a user's preferences. These embodiments offer functional advantages over existing types of devices in terms of holding the devices, interacting with devices, flexibility in function and selection of use of
10 these types of these devices, and improved security, authentication, and authorization among other objectives. One skilled in the art will understand, however, that the present invention may be practiced without several of the details described in the following description. Moreover, in the description that follows, it is understood that the figures related to the various embodiments are not to be interpreted as conveying any specific or
15 relative physical dimensions, and that specific or relative physical dimensions, if stated, are not to be considered limiting unless the claims expressly state otherwise. Further, illustrations of the various embodiments when presented by way of illustrative examples are intended only to further illustrate certain details of the various embodiments, and shall not be interpreted as limiting the scope of the invention.

20 To describe a first embodiment of the invention, suitable possible hardware devices will first be discussed. Figures 1A and 1B show a personal information terminal 100 of a first embodiment of the invention. The personal information terminal, in one form, features most significantly a display 104, an audio output jack 108, function control buttons 112, a storage media bay 116, and an antenna 120. A user of the personal
25 information terminal 100 can wear the personal information terminal 100 from a lanyard or a neck chain or strap (not shown) connected to eyelets 124. Alternatively, as shown in Figure 1B, the personal information terminal 100 can include a clip 128 to allow the personal information terminal 100 to be worn on a belt. Access door 132 allows managers of a personal information terminal 100 system to interchange content storage devices,

which will be further described below, change power supplies as necessary, and other relevant management tasks.

Figure 2 shows a radio frequency identification (“RFID”) tag 200. The operation of RFID tags 200 is known in the art, for applications such as automatic toll booth billing. A transmitter, in this case comprising part of the personal information terminal 100 (Figure 1A), transmits a polling signal. When the transmitter comes in range of the RFID tag 200 (Figure 2), an active or passive RF circuit 204 responds with an identifier signal, such as a serial number or other code, or substantive data content. In the embodiment shown in these figures, RF transmission is used between the personal information terminal 100 (Figures 1A and 1B) and the RFID tag 200 (Figure 2). It will be appreciated that other technologies could also be used, such as bar code reading, wherein the reader is part of the personal information terminal 100 (Figures 1A and 1B) and bar code tags would be posted to trigger the reader and, thus, the personal information terminal 100. Similarly, various other transmission media that allow for polling and sensing could be used.

Figure 3 shows a block diagram of the functional components of the personal information terminal 300. The personal information terminal 300 is controlled by a computer subsystem 304, which features a processor, a memory system, and suitable control logic to allow the computer subsystem 304 to govern the personal information terminal 300. Coupled to the computer subsystem 304 is a display 308 and an audio subsystem 312 which actually provide the content to a user of the system. It will be appreciated that another output device, such as a Braille tablet, could be included in the personal information terminal 300. The computer subsystem 304 receives input from function control buttons 320 and, in the system shown, a touch screen input 324 which would work in concert with the display 308.

Also coupled to the computer subsystem 304 are three additional system resources which enable the content delivery process. One of these is content storage 330. In this embodiment, the personal information terminal 300 does not receive content from a network, but is preloaded with all relevant content for the venue the user of the personal

information terminal 300 will explore. The content storage 330 could be in the form of a fixed disk, a CD drive, a mass memory array, or other suitable device for providing enough storage to hold the necessary content to be made available to the user. Also, the computer subsystem 304 is coupled to an RF transceiver 334 which polls for the presence of RFID tags 200 (Figure 2) to trigger content delivery. The RF transceiver 334 (Figure 3), through an attached RF antenna 338, transmits a polling signal, and then receives the responsive signals from the RFID tags (Figure 2). Also shown in Figure 3 is a user selected storage device 342, which can allow a user of the personal information terminal 300 to save content of particular interest to keep as a souvenir or for future study. The user selected storage device 342 could be a memory card, a memory stick, or any similar device which will allow content made available by the personal information terminal 300 to be recorded by the user.

Using the devices previously described, the operation of the personal information terminal and RFID tags will be discussed in the sample context of a museum gallery 400 shown in Figure 4. The gallery 400 holds a number of artifacts, such as a statute 404, a painting 414, and a number of smaller items in a showcase 420, including items 424, 434, 444, and 454. Each of these items is tagged with at least one RFID tag. The statute 404 bears RFID tag 408. The painting 414 bears two RFID tags 418. The reason for the two tags will be appreciated with further explanation. The smaller items in the showcase 420, including items 424, 434, 444, and 454, are tagged with RFID tags 428, 438, 448, and 458, respectively. It will be appreciated that these RFID tags need not necessarily be placed on these items, but can be placed in close proximity to the items. There is no need to mar, obscure, or otherwise taint any of the items by placing the tag on the item; placing the RFID tags nearby is sufficient.

Lastly, Figure 4 shows three personal information terminals, personal information terminal #1 460, personal information terminal #2 470, and personal information terminal #3 480, carried by three different users of the system. personal information terminal #1 460 is in proximity to RFID tag 408 on the statue 404, as shown by the fact that RFID tag 408 is within the detection range 464, shown by a dotted line. personal information terminal #2 470 is in proximity to RFID tag 418 as shown by the fact

that RFID tag 418 is within the detection range 474, shown by a dotted line. Finally, personal information terminal #3 480 is in proximity to RFID tag 458 as shown by the fact that RFID tag 458 is within the detection range 484, shown by a dotted line. It should be noted that personal information terminal #3 480 is not in proximity to RFID tag 448, as
5 shown by the fact that RFID tag 448 is outside the detection range 488, shown by a dotted line.

From the time the personal information terminals are activated, they transmit polling signals seeking to detect RFID tags. Before the users of the personal information terminals enter detection range of any of the tagged items, the personal information terminals will get no response to the polling signals. However, as each
10 personal information terminal comes within the detection range of an RFID tag, each personal information terminal will get a response indicating the serial or code number of that RFID tag, or receive substantive data content. The personal information terminal, using the received serial or code number as an index point, will access content stored on its
15 content storage relative to that received serial or code number which, if properly programmed, will be content on the item tagged with an RFID tag bearing that serial or code number. More specifically, as each of the users carrying or wearing the personal information terminals enters the detection range 464, 474, and 484 of the RFID tags 408, 418, and 458, respectively, each of the users will be offered and/or receive content on items
20 404, 414, and 454, respectively. Accordingly, users will be offered and/or receive content on whichever items they approach, in whatever order they approach the items. Less sensitive or responsive RFID tags can be used with items clustered closer together, such as items 424, 434, 444, 454, so that users can get content for a specific item to which they are most closely located without receiving content for other items. In addition, as shown with
25 regard to the large painting 414, more than one RFID tag 418 can be used so that users can receive content on such an object from different vantage points about the work without having to enter the detection range of a single RFID tag positioned at one corner of the work. As will be further appreciated, it is not a problem if the personal information

terminal simultaneously encounters multiple RFID tags that are encoded with either the same or different serial or code numbers.

Figure 5 presents in more detail the operation of the personal information terminal and RFID tag system. At 504, a user of a personal information terminal can set system parameters to tailor his experience. In a preferred variation of the embodiment, the user would be presented with a series of menus on a touch-sensitive display 104 (Figure 1) or audibly prompted by the personal information terminal 100 from which he could make his choices on the touch-sensitive display 104, using the function control buttons 112, or using voice selection. He might be prompted with audible instructions and information via the audio port 108 as well. The user will be able to select preferences such as in what language he wishes to receive content, whether he would like to be prompted for content delivery or have it delivered automatically, and whether he would like video content on the display 104, audio content via the audio port 108, or both. The personal information terminal 100 itself will indicate its device parameters so that scalable content appropriate for the device will be received as appropriate, as will be further discussed below. In addition, the user could be prompted for substantive preferences. With regard to the gallery example of Figure 4, the user could be asked to specify in which type of pieces he has interest, or perhaps in which artists or period he is interested. By entering these preferences, the user can focus the content received, so that the content delivered is relevant to his desires.

Once the preferences have been set at 504, the personal information terminal enters its repeating, working mode, which involves the personal information terminal continually polling for the presence of RFID tags at 508. As long as no RFID tag has been detected, the personal information terminal repeats the detection step at 508 until an RFID tag has been detected. Once an RFID tag has been detected at 508 and has identified the serial or code number associated with that RFID tag, at 512 to determine if the item the item bearing the located RFID tag meets with the user's preferences. At 516, considering classifying information stored in the personal information terminals own content storage, the personal information terminal determines if the content is desired by the user. For

example, if this is a piece of art in which the user is interested in terms of artist, period, etc., the content will then be made available to the user at 520 in the identified size, language, and other indicated parameters. However, if at 516 it is determined that the content is not within the user's expressed range of interest, the personal information terminal returns to the tag detection polling step at 508.

Once content is determined to be relevant or desired by the user, and the content is made available to the user, the user has a choice at 524 whether to experience the content. As previously mentioned, the user may elect to automatically receive content or be prompted with a visual or audible cue as to whether he would like to receive available content. In the former case, as shown in Figure 5, the content will be presented, and the user can choose to abort the content or receive it at 524. If the user chooses to abort the content, the personal information terminal again returns to the tag detection polling step at 508. On the other hand, if the user chooses to allow the content to proceed, he will then be given the choice to save or bookmark the content for later review at 528. If the user makes the choice to save the content, by activating the touch screen 104 (Figure 1) or a function control button 112, or by using voice selection, the content or a link thereto is saved to a media device at 532. As previously described, the user can keep that stored content as a study aid, souvenir, etc. After the content or link is saved, the personal information terminal returns to the tag detecting polling step at 508 to provide content on another tagged item. In the case where the user requests to first be prompted with content, the steps are similar. In this case, the user would not choose whether to abort content, but whether to receive it. If he chooses to receive the content, then the content would be made available to him; if not, the personal information terminal would return to the tag detecting polling step at 508.

It will be appreciated that many variations could be added to this process. For example, instead of the personal information terminal being preloaded with all the content, the personal information terminal's encounter of an RFID tag might prompt the personal information terminal to obtain the content from a content delivery device. In another embodiment, a central content delivery device monitors when a user's personal

information terminal, bearing its own RFID tag, approaches an object's RFID tag. Then, the content delivery device will transmit relevant content to the personal information terminal. Lastly, because of the nature of the object of interest, a content delivery device may send content to the personal information terminal of any user who approaches within a
5 certain proximity. In addition, users could be given the option to pause content, review content again, terminate content, skip ahead in content, and other options which still comport with the broad concepts of this embodiment of the invention.

A second embodiment of the invention, instead of using RFID tags to trigger delivery of content stored in the personal information terminal, uses a plurality of
10 transmitters to engage the personal information terminal and transmit content to the personal information terminal at that moment. In this embodiment of the invention, content can be updated instantaneously, without accessing the user's personal information terminal. For sake of example, the first embodiment of the invention already described may be well-suited for more static types of venues, such as museums or historical sites. On the other
15 hand, the second embodiment where content is not preloaded but can be transmitted allows for changing the content much more easily by various means. This second embodiment might be well suited to marketing and entertainment venues, where advertisers can change specials, offer sale prices and other promotions, or transmit information about what is taking place on that day or even at that moment.

20 Figure 6 shows a block diagram of a personal information terminal adapted for the second embodiment of the invention. Most of the devices and their operation is similar to the personal information terminal 300 of the first embodiment of the invention described in Figure 3. Again, the personal information terminal 600 is controlled by a computer subsystem 604, which features a processor, a memory system, and suitable
25 control logic to allow the computer subsystem 604 to govern the personal information terminal 600. Coupled to the computer subsystem 604 is a display 608 and an audio subsystem 612 which actually provide the content to a user of the system. It will be appreciated that another output device, such as a Braille tablet, could be included in the personal information terminal 600. The computer subsystem 604 receives input from

function control buttons 620 and, in the system shown, a touch screen input 624 which would work in concert with the display 608.

Coupled to the computer subsystem 604 in this second embodiment are two additional system resources which enable the content delivery process. One of these is downloaded content storage 642. In this second embodiment, the personal information terminal 600 operated not from stored content as in the first embodiment, but instead the personal information terminal receives content from a network of content delivery devices. Content is received via an RF transceiver 634 with an associated RF antenna 638 which polls for the presence of content delivery devices, and, upon detecting a content delivery device holding relevant content, the RF transceiver 634 receives the content. As the content is received, it is stored in the downloaded content storage 642.

By contrast with Figure 3 and the personal information terminal 300 of the first embodiment, the second embodiment of the personal information terminal 600 of Figure 6 does not include user selected storage 342 (Figure 3). In the first embodiment, if the user wished to store content, it would be saved locally on the personal information terminal 300 to allow the user to easily take it with him as a souvenir. In this second embodiment, however, because the content is contemplated to be more in the nature of advertising or more temporal in nature, or by contrast is highly valued, limited edition content available for purchase only, it is less likely the user would want or could take such a tangible record. Instead, if a user wishes to log information about an event or a merchant, he can signal his preference to the content delivery device from which the content was received. Then, the operator of that content delivery device can contact the user, or that information can be uploaded to a network such as the Internet where the user later can retrieve that information.

A content delivery device 700 suited for the second embodiment is shown in Figure 7A. Either a special purpose device or a general purpose computer could be adapted to perform these functions. The content delivery device 700 includes a computing system 704 which allows management of content and content delivery parameters. The content delivery device can be controlled through a keyboard 708 and the content and delivery

parameters monitored on a display 712. Content can be loaded and stored in the computing system 704 through a media bay 716 which can receive CDs, DVDs, or other media. The content delivery device also can receive content by wired networks through access jacks (not shown) or through wireless transmission. The transmitter 720 might be adapted to fit a standard personal computer expansion slot, and communicate via an external antenna 724. As with the first embodiment of the invention, it will be appreciated that RF technology is not the only medium which would allow for the functions of the present invention. Bar code scanning, infrared technology, spread spectrum or other spectra, and other such media also could be used.

Figure 7B shows an alternative content delivery device 750. The content delivery device 750 comprises a base station 754 which incorporates the computer system, storage, and transceiver as the content delivery device 700 of Figure 7A. The base station 754 (Figure 7B) also incorporates a media bay 758 and access jacks (not shown) to receive network connections with which to receive content. An RF antenna 770 works with the RF transceiver (not shown) to exchange content with personal information terminals and other devices (not shown). A principal difference is that user input and output is handled through a removable personal data device 758, preferably with a touch-sensitive color display 762 and operable to respond to voice commands. The removable personal data device 758 not only is the principal input and output device for the system, but can be removed to scan RFID tags to determine if the tags provide accurate content, to perform inventories, and similar functions.

Figure 8 shows a block diagram of the content delivery device 800. The content delivery device 800 is controlled by a computer subsystem 804, which features a processor, a memory system, and suitable control logic to allow the computer subsystem 804 to govern the content delivery device 800. Coupled to the computer subsystem 804 is a display 808 and an audio subsystem 812 which allow the content delivery device user to view available content and monitor system functions. The computer subsystem 804 receives input from function control buttons 820 or voice commands, and, in the system shown, a media 824 from new content can be added.

Also coupled to the computer subsystem 804 are three additional system resources which enable the content delivery process. One of these is content storage 842 which holds the content that will be transmitted to the personal information terminals. The computer subsystem 804 is coupled to an RF transceiver 834 which receives polling
5 transmissions from personal information terminals and responds thereto, both through an attached RF antenna 838. Also shown in Figure 8 is a customer information storage device 842, which can the operate or the content delivery device 800 to track information on customers who received and accepted content from the content delivery device.

Figure 9 shows a flowchart of the operations of the second embodiment of
10 the present invention. As in the first embodiment, the process begins at 904 with a user setting his preferences. The user can indicate her language, or whether she wants visual content, audio content, or both. In addition, she can indicate in what areas she has substantive interest, such as whether she is interested in shopping for a certain type of clothing, looking for a certain type of cuisine, looking for a certain "percent off" sale,
15 special promotion, or free gifts with purchase, or is interested in seeing a certain type of show. Again, preferably, this step is a menu driven process facilitated by the display and/or audio made available to the user via the personal information terminal.

After the preferences are set, the personal information terminal polls at 908
20 for signals from content delivery devices. If a signal is not detected at 908, the personal information terminal continues to poll for signals. When a signal is received, the personal information terminal initiates a communications handshaking process at 912 to allow for the content delivery device and personal information terminal to exchange information about the user and about the content stored on the content delivery device. At 916, if it is
25 determined that the user preferences stored in the personal information terminal do not correlate to content available on the content delivery device, the personal information terminal reverts polling for further transmitter signals at 908 and no content is provided. If there is content of interest that meets the user's specified preferences, at 920 the content delivery device sends that content to the personal information terminal. Once the content has been received, the content is made available to the user at 924. As previously

mentioned in connection with the first embodiment of the invention, the user may elect to automatically receive content or be prompted with a visual or audible cue as to whether she would like to receive available content. In the former case, as shown in Figure 9, the content will be presented, and the user can choose to abort the content, receive it, pause it, etc., at 928. If the user chooses to abort the content, the personal information terminal again returns to the signal polling step at 908.

On the other hand, if the user chooses to allow the content to proceed, the content is provided at 932. In a preferred variation, if the content is accepted, the content delivery device will receive a signal from the personal information terminal reporting delivery at 936 for tracking or follow up purposes. Next, if the user was interested in the content, she can bookmark that vendor's content at 940. Unlike the first embodiment of the invention, this information is not stored on the personal information terminal, but is transmitted to the content delivery device and possibly uploaded to a network such as the Internet from which she can later retrieve that information at 944. Whether the information is stored or not, the process then reverts to the signal detection phase at 908.

It will be appreciated that many variations could be added to this process. Users could be given the option to pause content, review content again, skip ahead in content, and other options which still comport with the broad concepts of this embodiment of the invention. Moreover, if a vendor provides a coupon, the user may be given the option to store or lock in that coupon to present to the vendor to take advantage of the deal offered.

It also should be appreciated, as referenced with regard to the personal information terminal 100 of Figure 1B, that such a personal information terminal could have interchangeable modules, so that once a tourist disembarks from a cruise ship or lands at an airport, he or she might obtain a module that is directed particularly toward concepts in which he or she is interested. For example, it is possible that different content delivery device networks might exist at different frequencies for different types of interests or for different languages, types and sizes of content, or different networks might observe slightly different transmission protocols. Changing a module indicating these changes with circuits

adapted for those needs would allow the personal information terminal to be adapted for these different environments.

From the foregoing it will be appreciated by one skilled in the art that, although specific embodiments of the invention have been described herein for purposes of illustration, various modifications may be made without deviating from the spirit and scope of the invention. Embodiments of the invention could receive still picture content, full motion video with sound, or any other form of content. Moreover, the embodiments herein disclosed could be adapted for many other applications, such as hospitals, amusement parks, commercial and residential buildings, shopping areas, military complexes and installations, customs and immigration boards and services, sporting events, parking areas, manufacturing facilities, hotels, resorts, clubs, and golf courses. With a sufficient network of RFID tags, such a system could become a virtual tour guide which provides location and direction information by sensing RFID tags instead of using GPS technology. Again, RF is only one medium that can be used; bar code scanning, infrared sensing, and other identification media could be used. Accordingly, the invention is not limited except as by the appended claims.

CLAIMS

1. A content delivery system, comprising:
 - a computer subsystem comprising a processor, a memory system, and a control logic;
 - an output system coupled with the computer subsystem, the output system comprising at least one of a display and an audio generation system;
 - a user input system coupled with the computer subsystem, the user input system comprising at least one of at least one function control button and a touch-sensitive display;
 - a content storage system coupled with the computer subsystem, the content storage system being operable to store information about each of a plurality of items of interest indexed with respective index keys; and
 - a wireless communications subsystem coupled with the computer subsystem, the wireless communications subsystem being responsive to a presence of one of a plurality of identifier tags, the plurality of identifier tags signaling the respective index keys associated with the respective plurality of items of interest so that, upon the wireless communications subsystem indicating the presence of one of the plurality of identifier tags, the computer subsystem conveys to the output system the information about the respective item of interest.

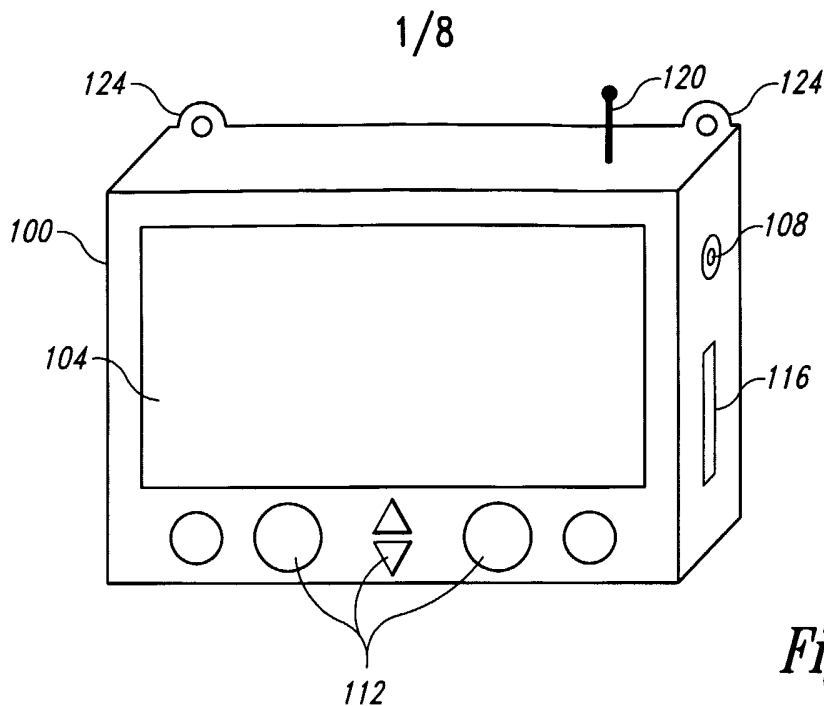

Fig. 1A

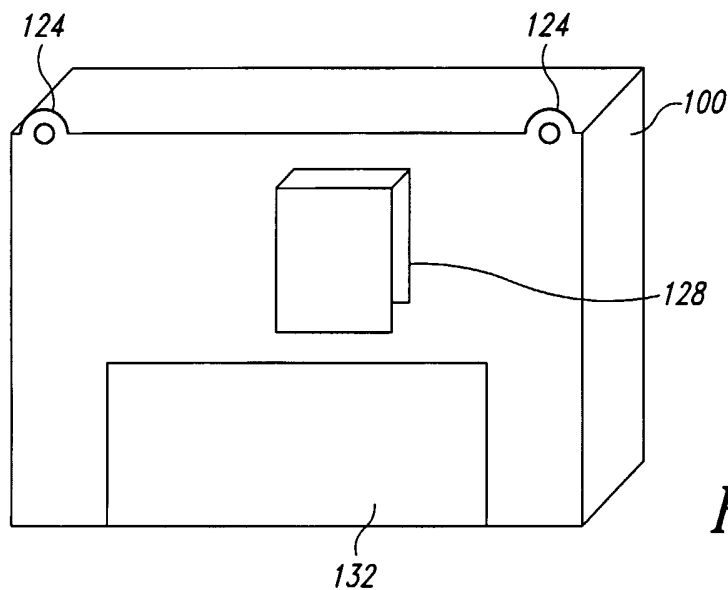

Fig. 1B

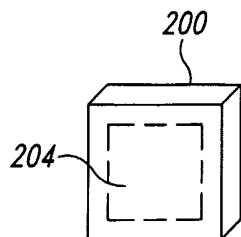

Fig. 2

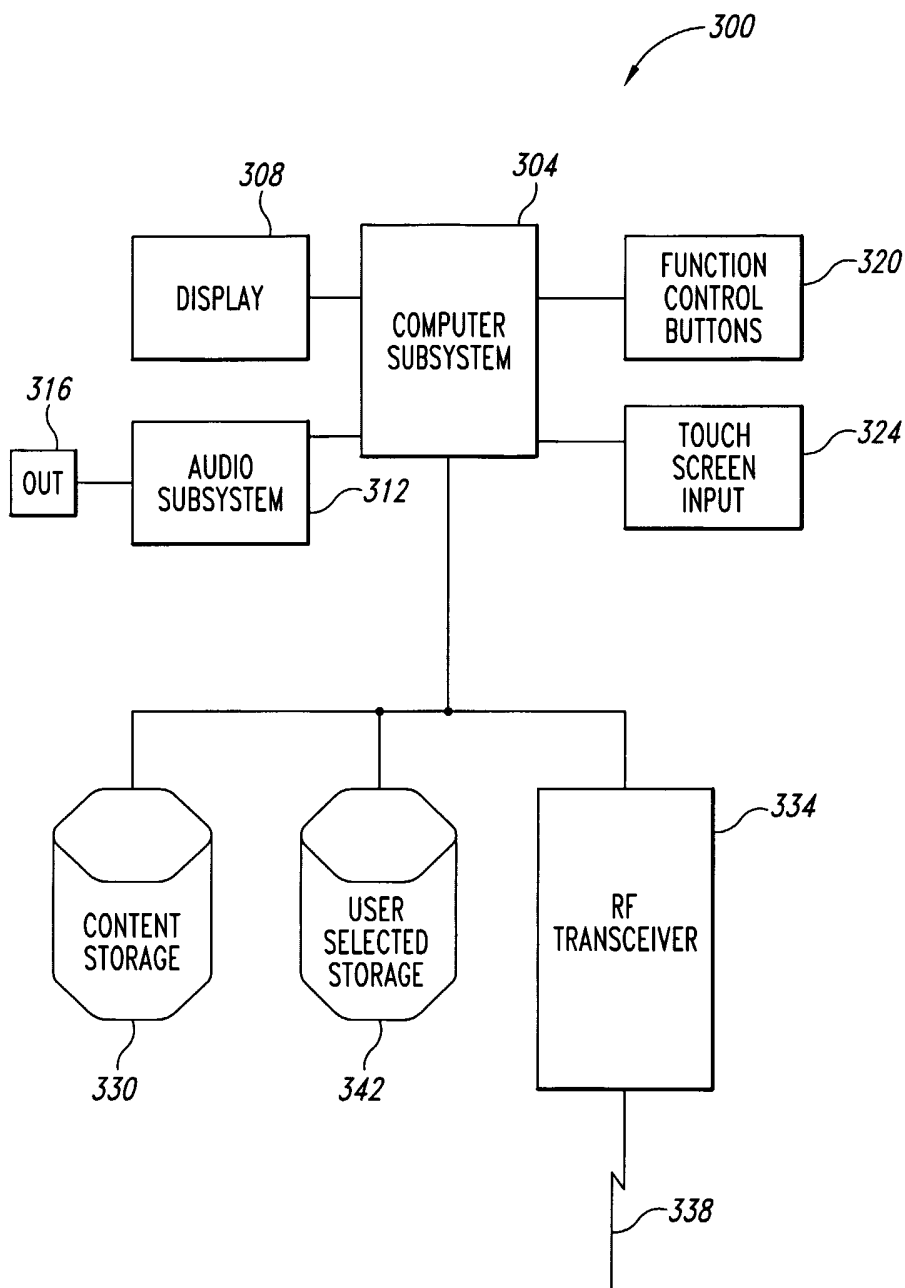

Fig. 3

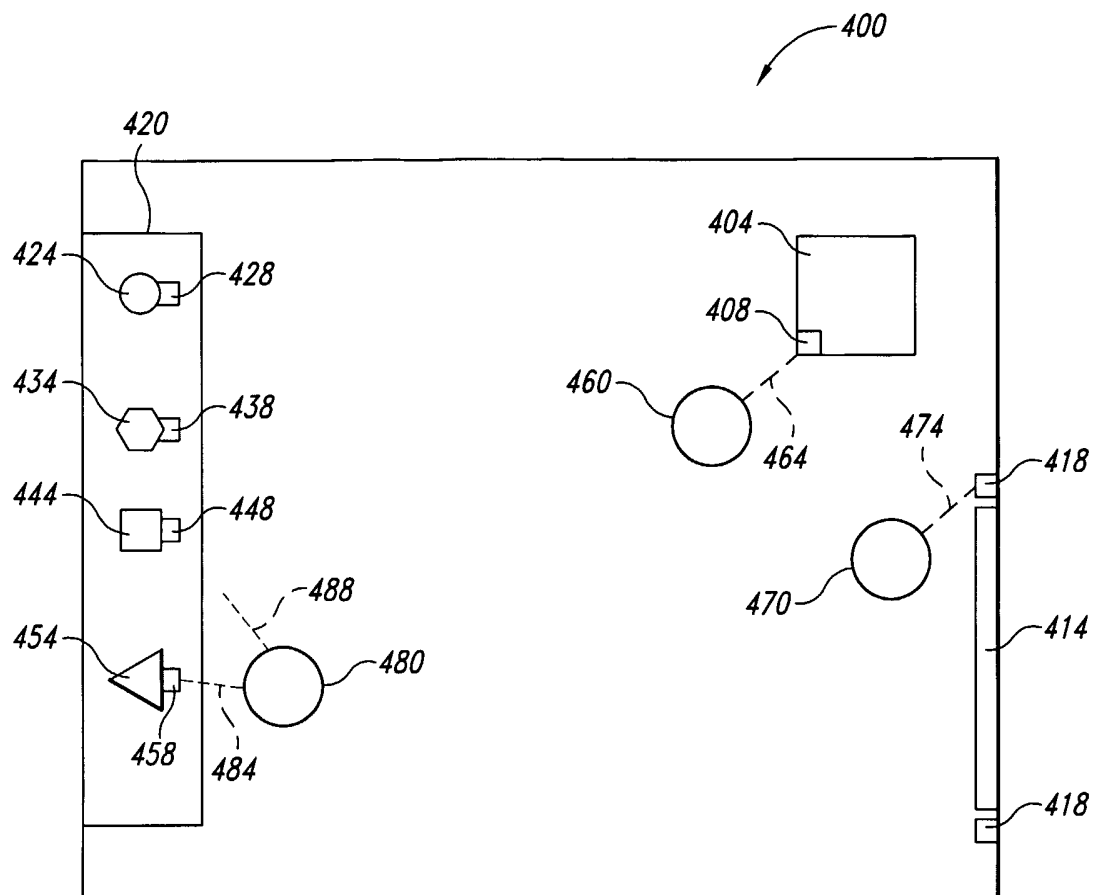

Fig. 4

4/8

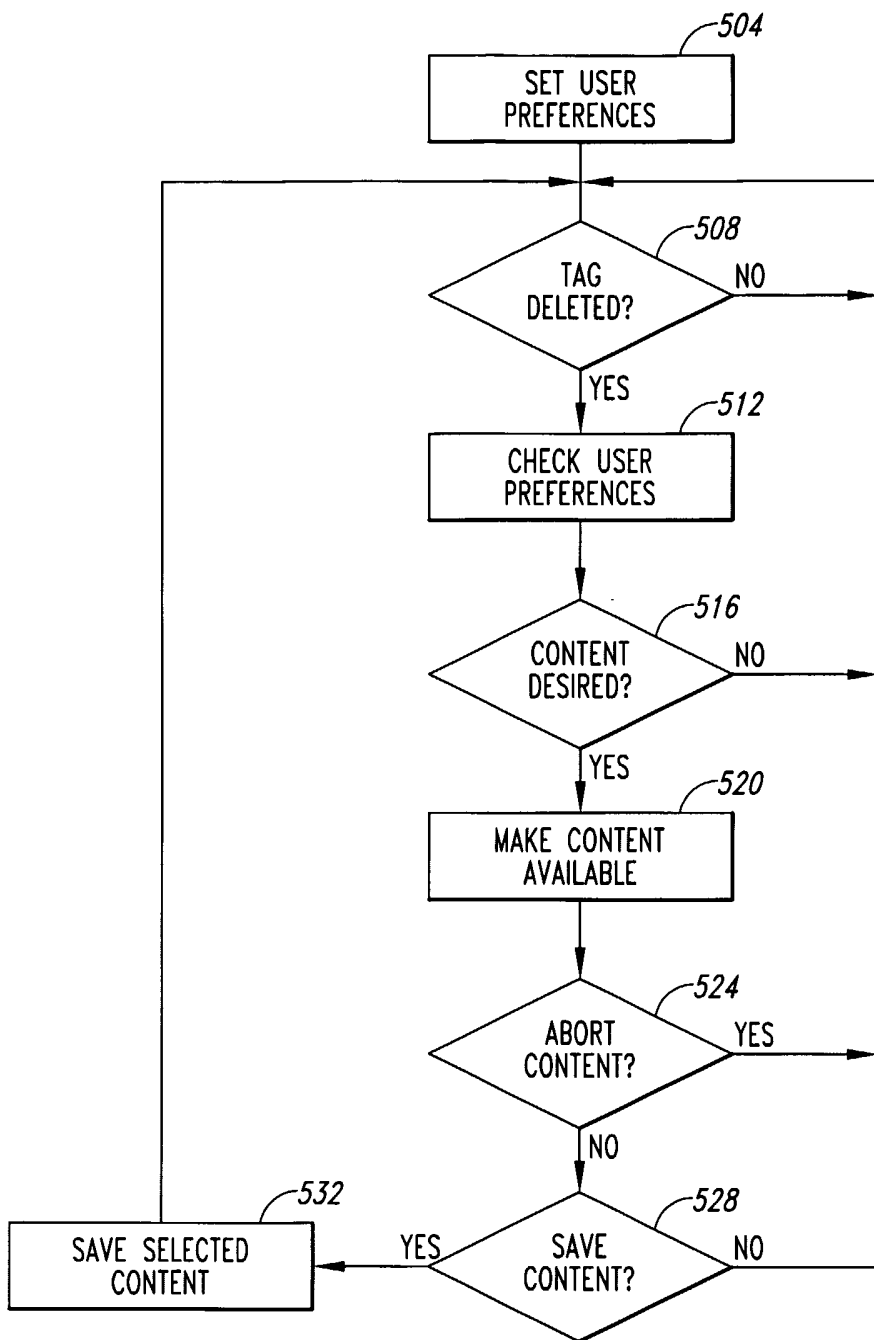

Fig. 5

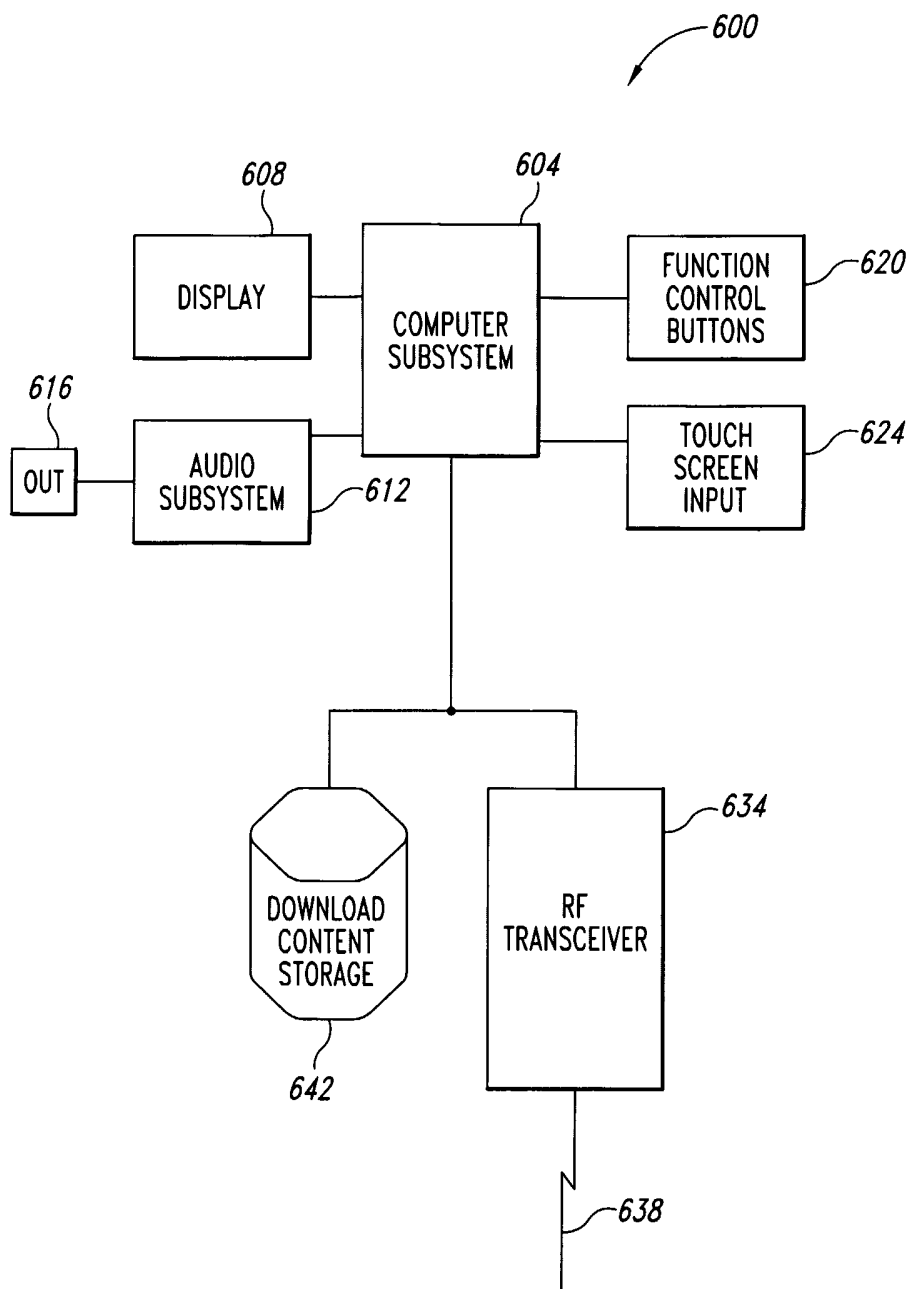

Fig. 6

6/8

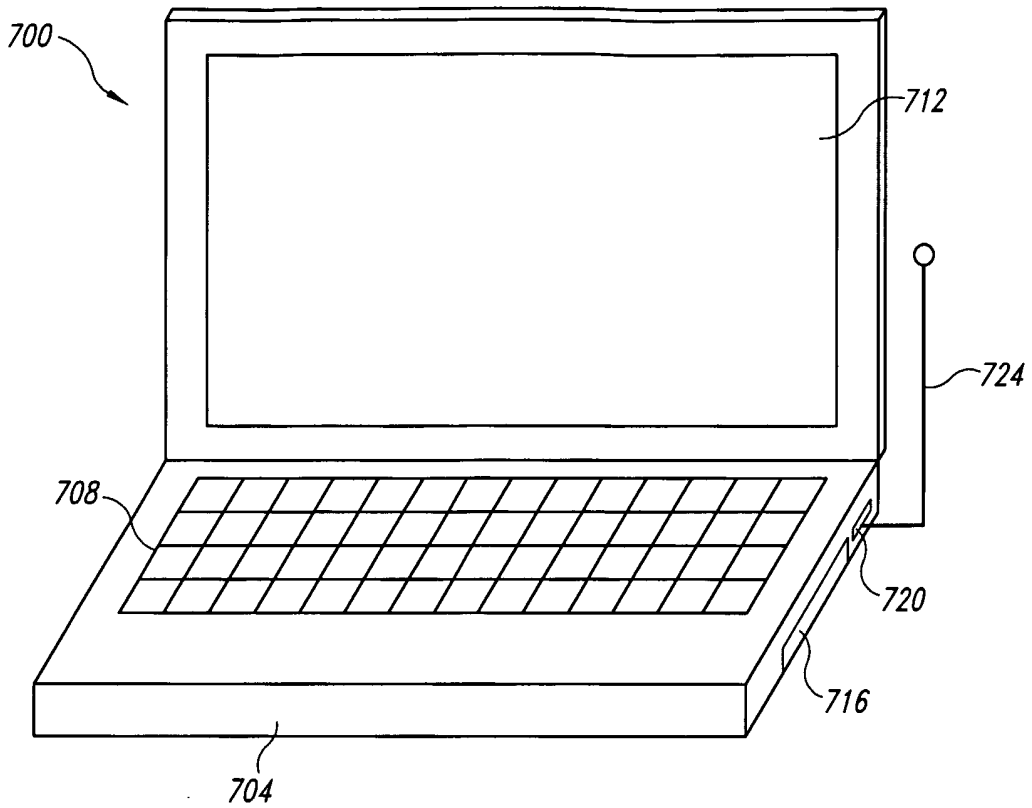

Fig. 7A

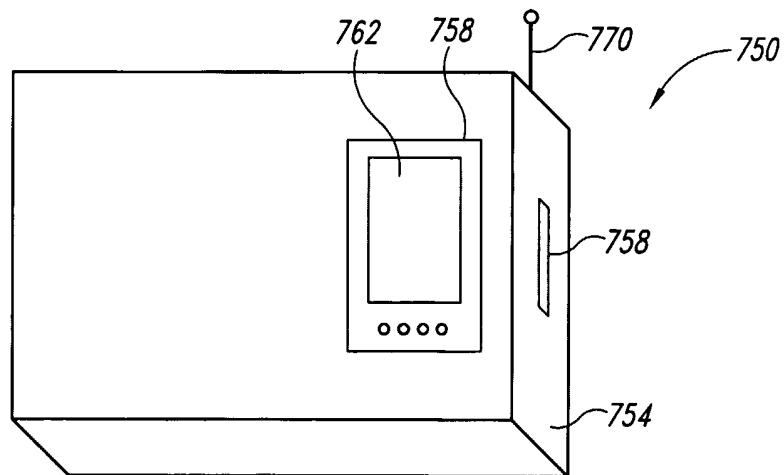

Fig. 7B

7/8

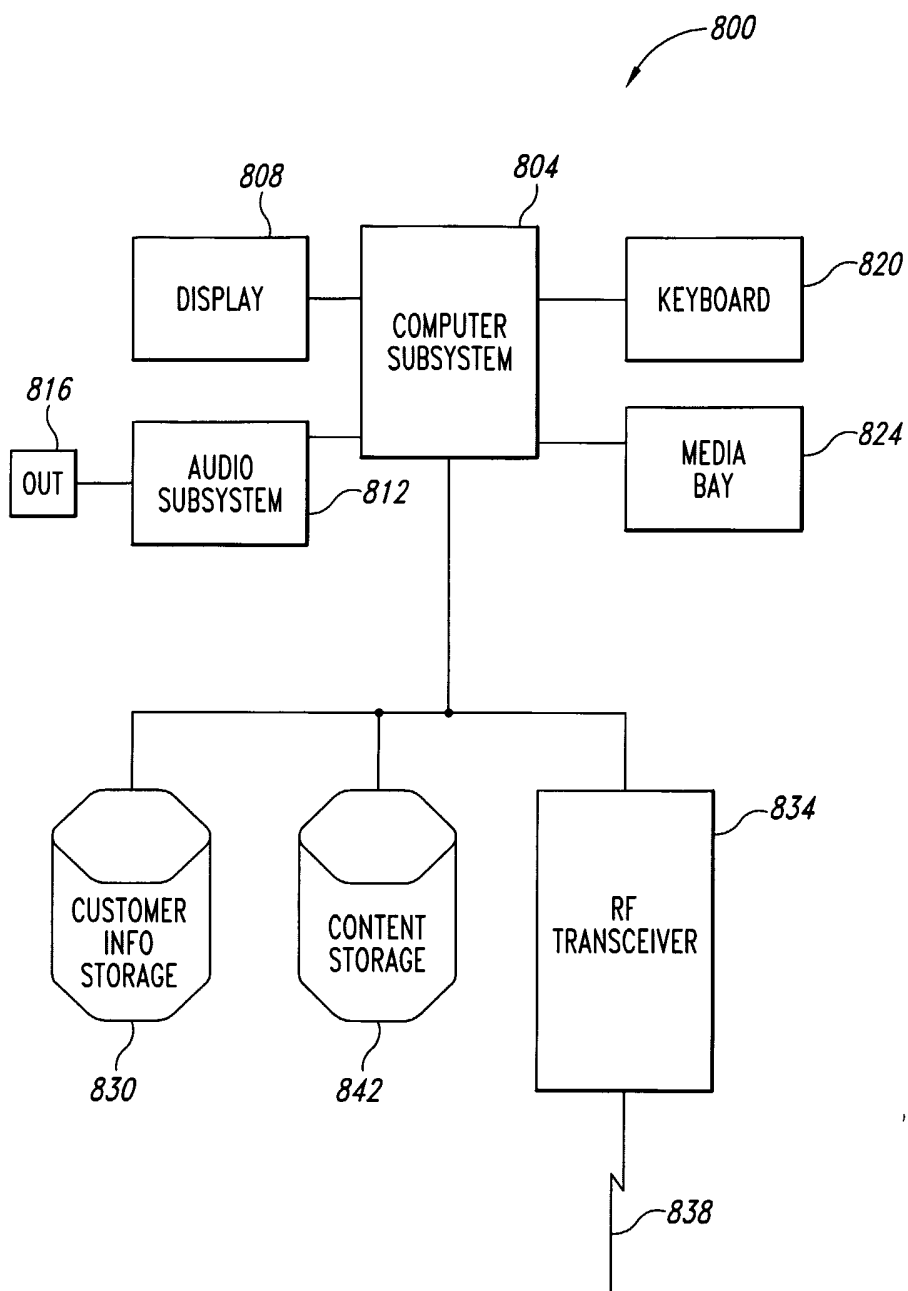

Fig. 8

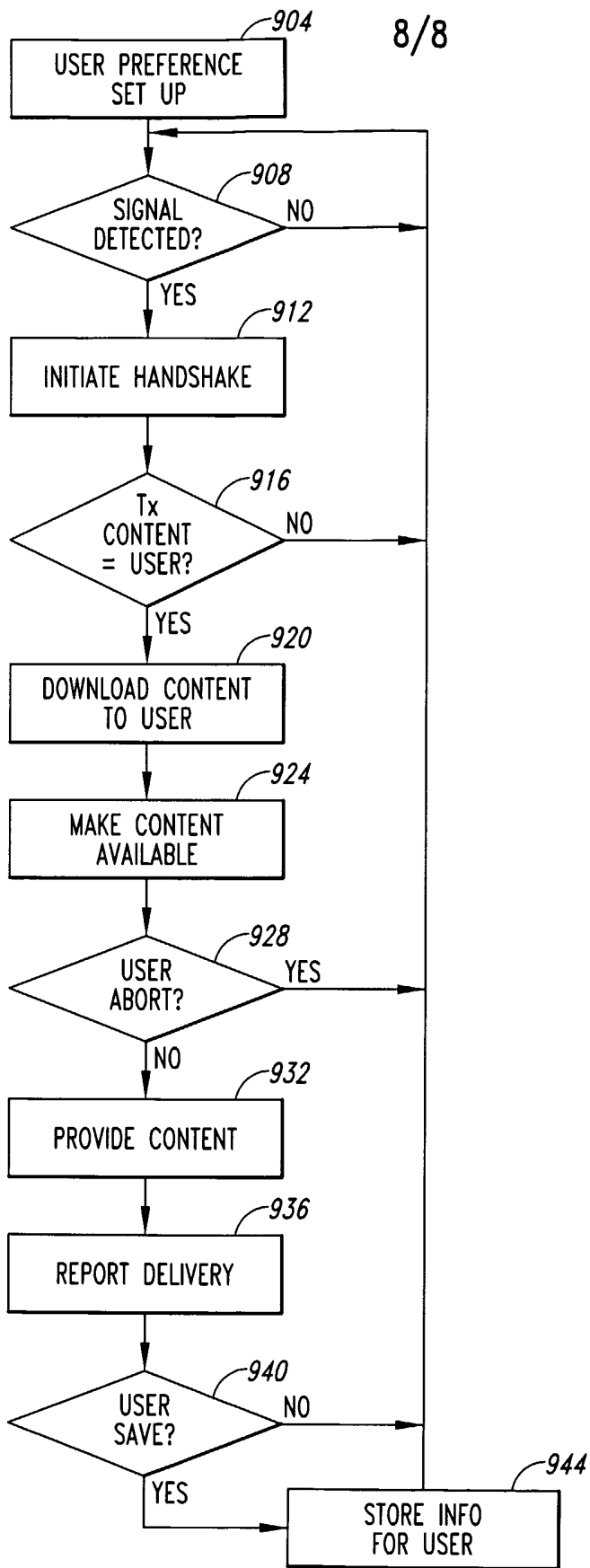

Fig. 9

INTERNATIONAL SEARCH REPORT

International application No.
PCT/US02/22805

A. CLASSIFICATION OF SUBJECT MATTER

IPC(7) : G06K 05/00
US CL : 235/380

According to International Patent Classification (IPC) or to both national classification and IPC

B. FIELDS SEARCHED

Minimum documentation searched (classification system followed by classification symbols)
U.S. : 235/380, 375, 383

Documentation searched other than minimum documentation to the extent that such documents are included in the fields searched

Electronic data base consulted during the international search (name of data base and, where practicable, search terms used)
Please See Continuation Sheet

C. DOCUMENTS CONSIDERED TO BE RELEVANT

Category *	Citation of document, with indication, where appropriate, of the relevant passages	Relevant to claim No.
A, P	WO 02/15,601 A (KONINKLIJKE PHILIPS ELECTRONICS NV) 21 February 2002 (21.04.2002), see entire document.	None
A	US 5,929,848 A (ALBUKERK et al) 27 July 1999 (27.07.1999), see entire document.	None
A	US 5,703,564 A (BEGUM et al) 30 December 1997 (30.12.1997), see entire document.	None
A	US 5,420,606 A (BEGUM et al) 30 May 1995 (30.05.1995), see entire document.	None

Further documents are listed in the continuation of Box C.

See patent family annex.

* Special categories of cited documents:	
"A" document defining the general state of the art which is not considered to be of particular relevance	"T" later document published after the international filing date or priority date and not in conflict with the application but cited to understand the principle or theory underlying the invention
"E" earlier application or patent published on or after the international filing date	"X" document of particular relevance; the claimed invention cannot be considered novel or cannot be considered to involve an inventive step when the document is taken alone
"L" document which may throw doubts on priority claim(s) or which is cited to establish the publication date of another citation or other special reason (as specified)	"Y" document of particular relevance; the claimed invention cannot be considered to involve an inventive step when the document is combined with one or more other such documents, such combination being obvious to a person skilled in the art
"O" document referring to an oral disclosure, use, exhibition or other means	"&" document member of the same patent family
"P" document published prior to the international filing date but later than the priority date claimed	

Date of the actual completion of the international search

24 September 2002 (24.09.2002)

Date of mailing of the international search report

03 OCT 2002

Name and mailing address of the ISA/US

Commissioner of Patents and Trademarks
Box PCT
Washington, D.C. 20231

Facsimile No. (703)305-3230

Authorized officer

Mark Tremblay *[Signature]*

Telephone No. 703 308 0956

INTERNATIONAL SEARCH REPORT

PCT/US02/22805

Continuation of B. FIELDS SEARCHED Item 3:

EAST

search terms: museum, shelf tag, RFID, shopping cart, advertisement, wireless