



US00D748928S

(12) **United States Design Patent**
Carey

(10) **Patent No.:** **US D748,928 S**

(45) **Date of Patent:** **** Feb. 9, 2016**

(54) **CRAFT TABLE**

(71) Applicant: **American Crafts, L.C.**, Orem, UT (US)

(72) Inventor: **Tavnir J. Carey**, West Jordan, UT (US)

(73) Assignee: **American Crafts, L.C.**, Lindon, UT (US)

(**) Term: **14 Years**

(21) Appl. No.: **29/525,976**

(22) Filed: **May 5, 2015**

Related U.S. Application Data

(63) Continuation-in-part of application No. 29/454,196, filed on May 7, 2013, now Pat. No. Des. 728,263.

(51) **LOC (10) CL.** **06-04**

(52) **U.S. CL.**
USPC **D6/555**

(58) **Field of Classification Search**
USPC D6/553, 555, 567, 569
CPC A47F 3/005; A47F 3/00; A47F 3/06;
A47F 7/00; A47F 5/0025; A47B 67/02;
A47B 95/008; A47B 47/027; A47G 19/28

See application file for complete search history.

(56) **References Cited**

U.S. PATENT DOCUMENTS

D293,403 S *	12/1987	Umanoff et al.	D6/555
D549,025 S *	8/2007	Van Alstyne	D6/555
D592,435 S *	5/2009	Jasman	D6/555
D618,939 S *	7/2010	Gibbs	D6/555
D632,115 S *	2/2011	Gibbs	D6/555
D632,116 S *	2/2011	Gibbs	D6/555
D632,117 S *	2/2011	Gibbs	D6/555

* cited by examiner

Primary Examiner — Brian N Vinson

(74) *Attorney, Agent, or Firm* — Durham Jones & Pinegar, P.C. Intellectual Property Law Group

(57) **CLAIM**

The ornamental design for a craft table, as shown and described.

DESCRIPTION

FIG. 1 is a top, front, and right side perspective view of a craft table showing my new design;
FIG. 2 is a front elevational view thereof;
FIG. 3 is a right side elevational view thereof;
FIG. 4 is a top plan view thereof;
FIG. 5 is a bottom plan view thereof;
FIG. 6 is a rear elevational view thereof; and,
FIG. 7 is a front and side perspective view thereof, shown in a closed position.
The portions of the craft table shown in broken lines form no part of the claimed design.

1 Claim, 6 Drawing Sheets

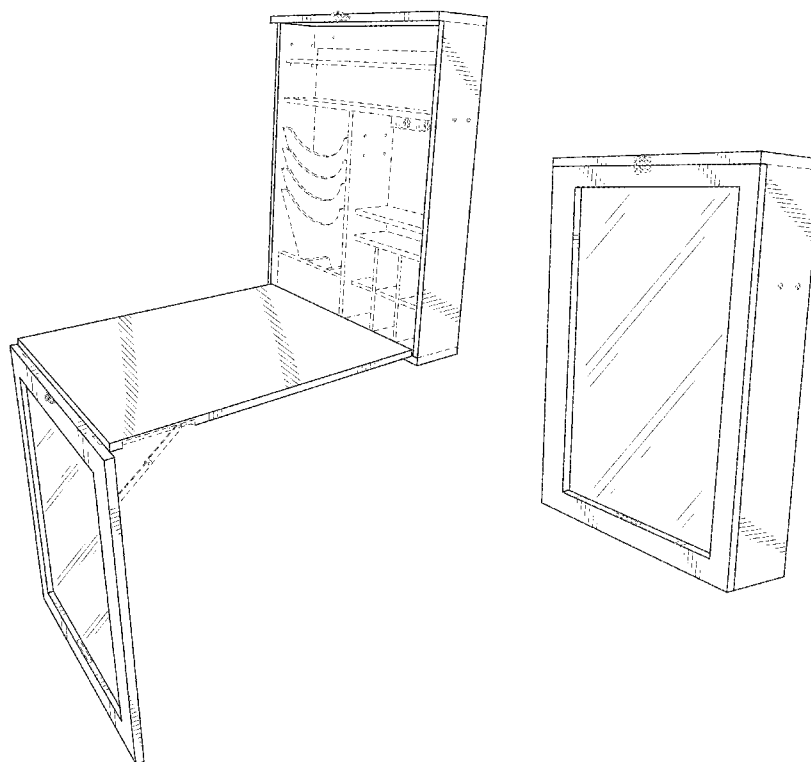

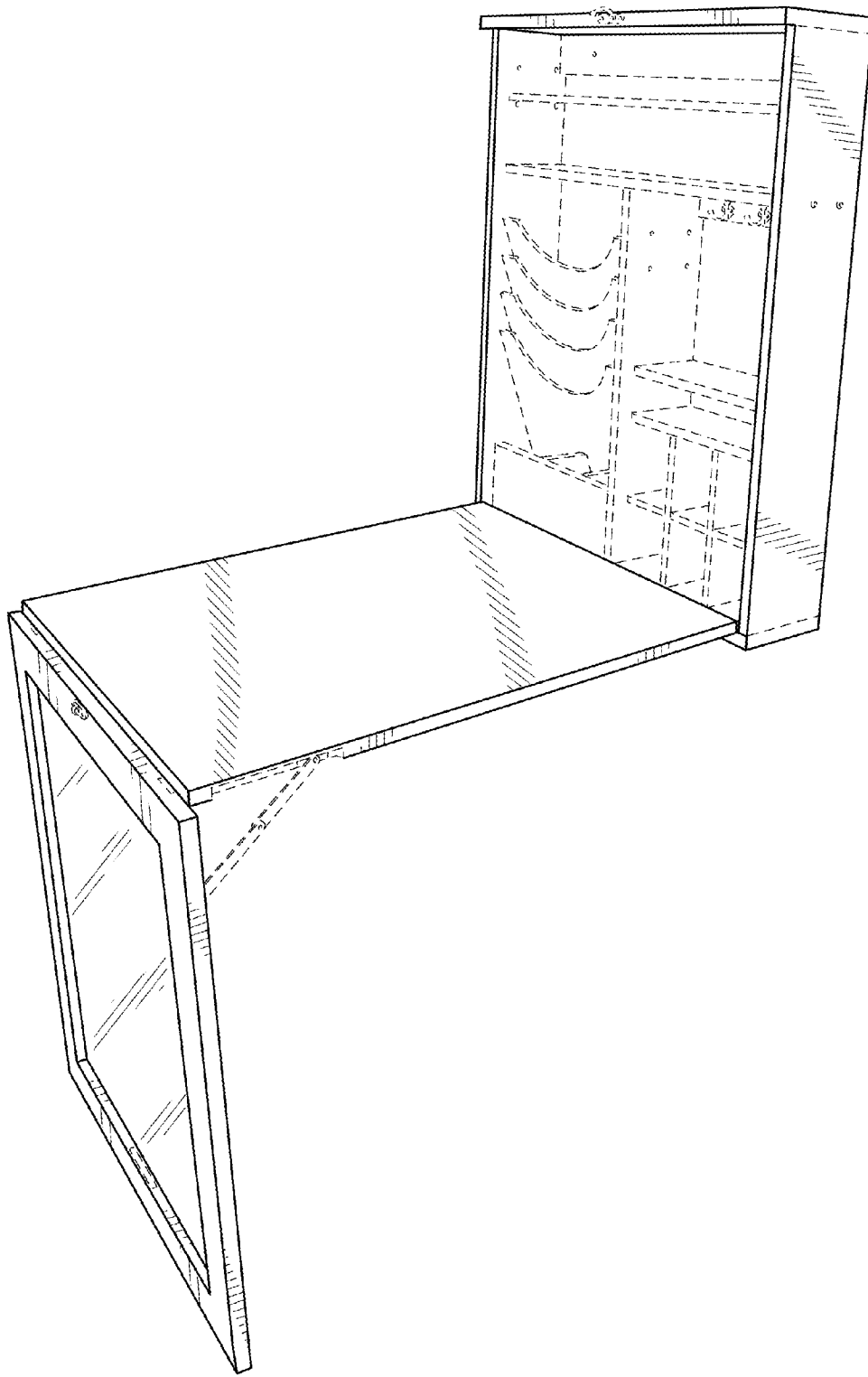

FIG. 1

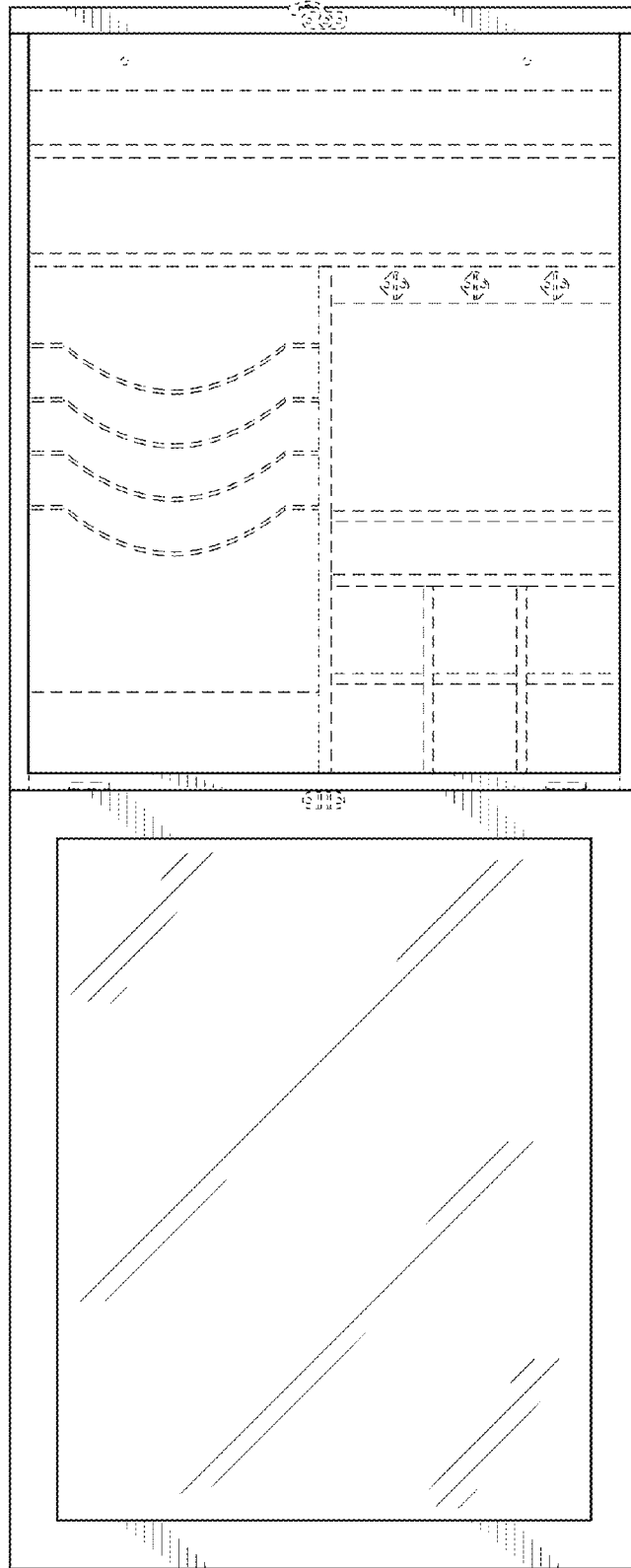

FIG. 2

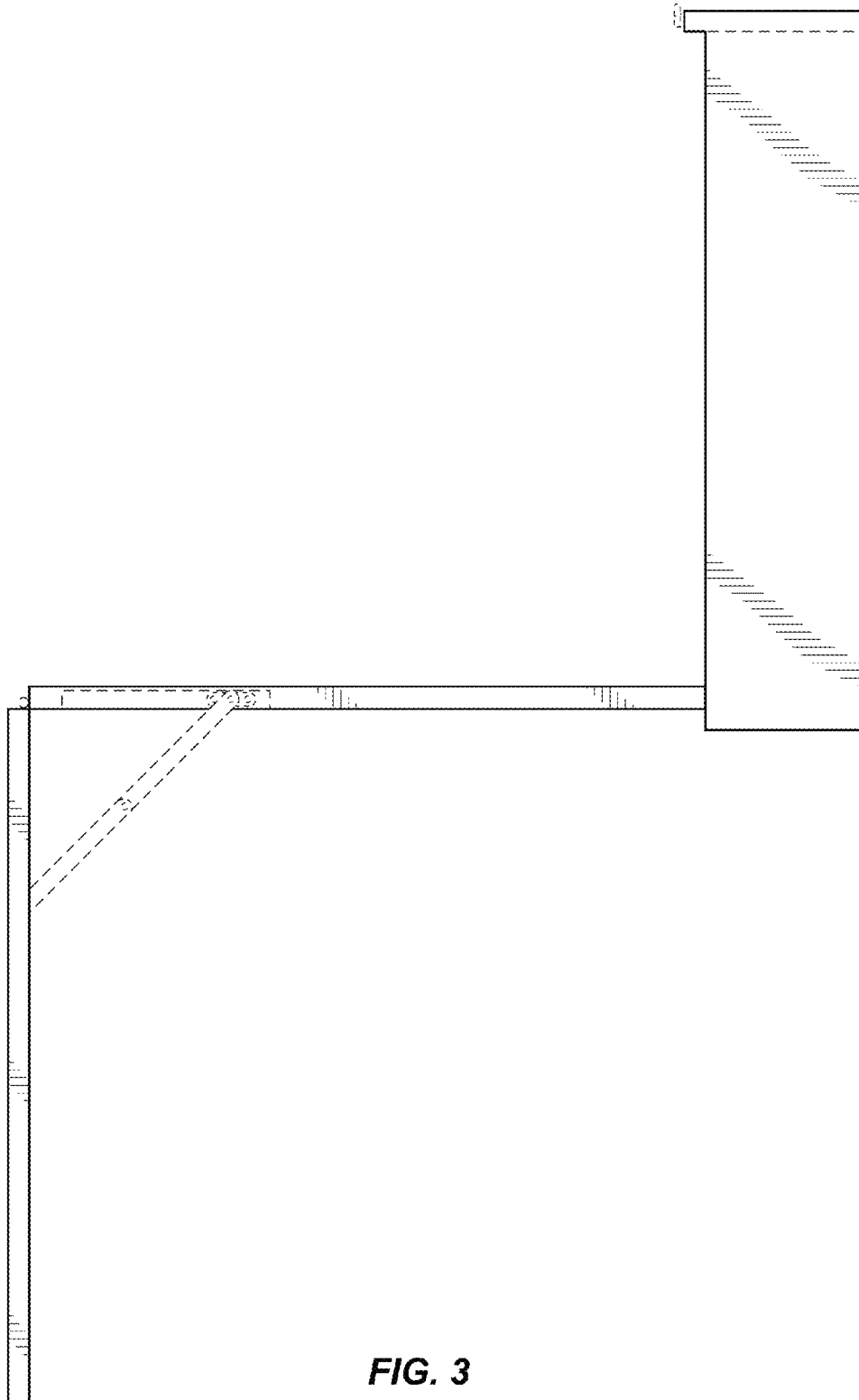

FIG. 3

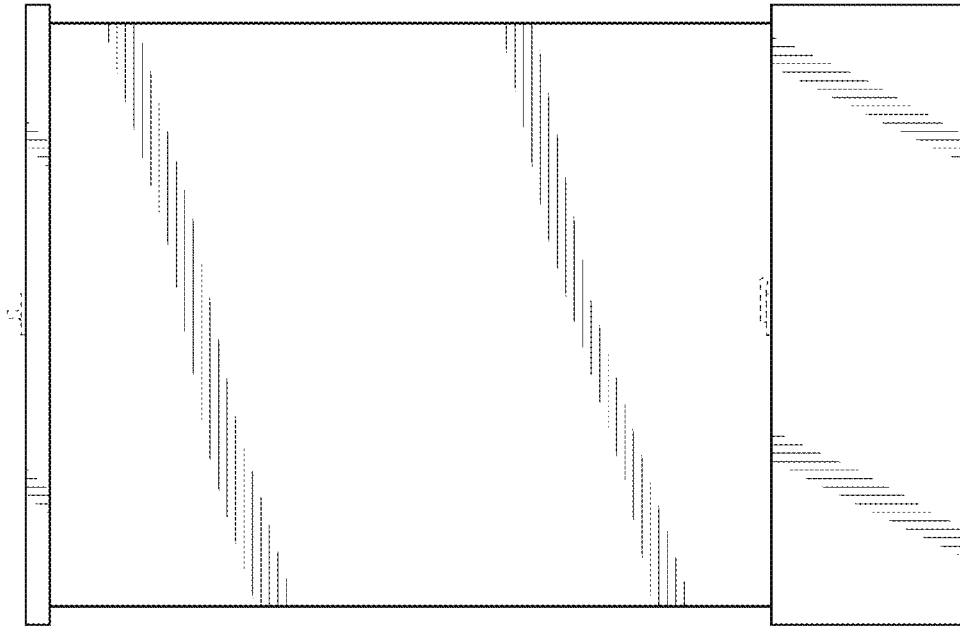

FIG. 4

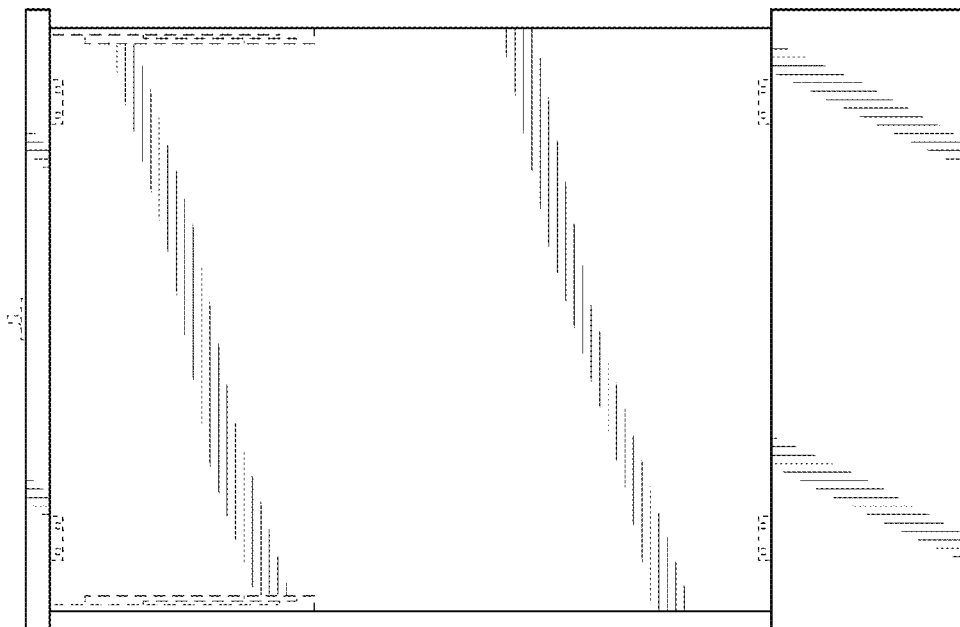

FIG. 5

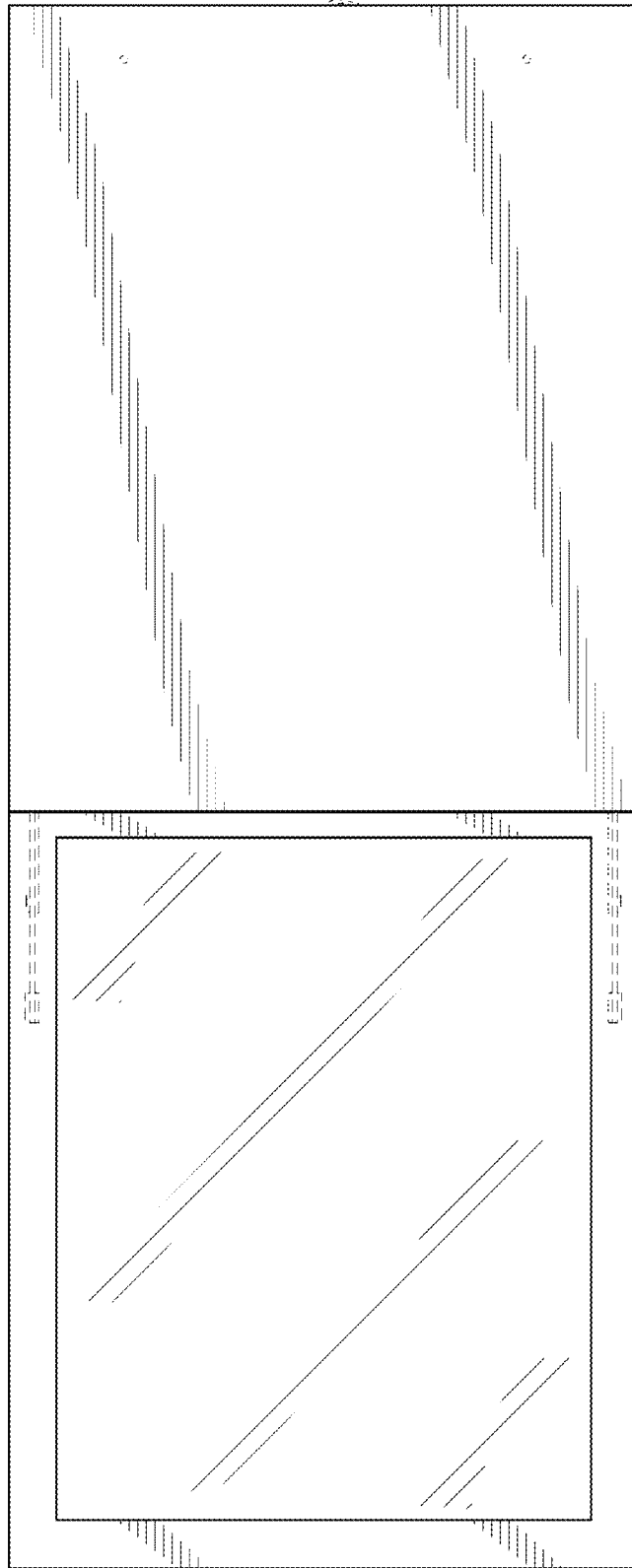

FIG. 6

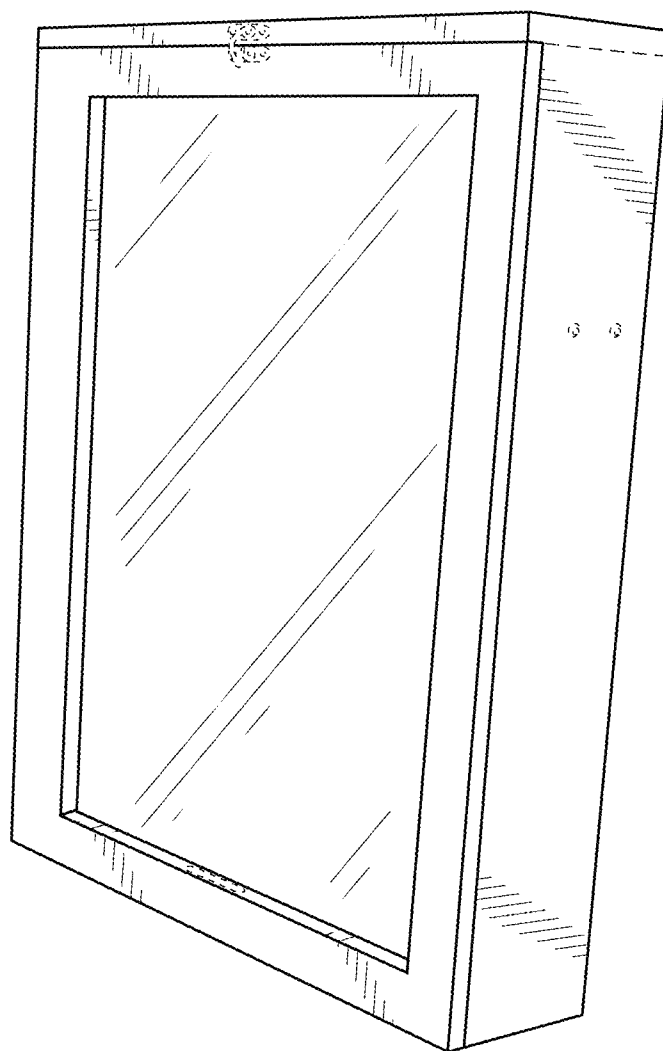

FIG. 7