



US00D845035S

(12) **United States Design Patent**  
**Raad et al.**

(10) **Patent No.:** **US D845,035 S**  
(45) **Date of Patent:** **\*\* Apr. 9, 2019**

- (54) **BACK PILLOW**
- (71) Applicant: **Odracir, LLC**, Boca Raton, FL (US)
- (72) Inventors: **Ricardo Raad**, Boca Raton, FL (US);  
**Juan Najas**, Boca Raton, FL (US)
- (73) Assignee: **Odracir, LLC**, Boca Raton, FL (US)
- (\*\*) Term: **15 Years**
- (21) Appl. No.: **29/642,123**

D531,315 S \* 10/2006 Caudra ..... D24/183  
 D793,769 S \* 8/2017 Nacey ..... D6/601  
 D833,628 S \* 11/2018 Davis ..... D24/190  
 2008/0109961 A1\* 5/2008 Yu ..... A47G 9/10  
 5/636  
 2008/0115284 A1\* 5/2008 Hiatt ..... A61G 7/065  
 5/632

\* cited by examiner

*Primary Examiner* — R. Johnson  
 (74) *Attorney, Agent, or Firm* — Johnson | Dalal; Mark  
 C. Johnson

- (22) Filed: **Mar. 27, 2018**
- (51) **LOC (11) Cl.** ..... **06-09**
- (52) **U.S. Cl.**  
USPC ..... **D6/601**
- (58) **Field of Classification Search**  
USPC ..... D6/596, 597, 599, 601  
CPC ..... A47G 9/10; A47G 9/1027; A47G 9/1054;  
A47G 9/1072; A47G 9/1081; A47G  
9/109; A47G 2009/1018  
See application file for complete search history.

(57) **CLAIM**

The ornamental design for a back pillow, as shown and described.

**DESCRIPTION**

FIG. 1 is a top perspective view of a back pillow in accordance with the present invention;  
 FIG. 2 is a bottom perspective view of the back pillow in FIG. 1;  
 FIG. 3 is a top plan view of the back pillow in FIG. 1;  
 FIG. 4 is a bottom plan view of the back pillow in FIG. 1  
 FIG. 5 is a left-side elevational view of the back pillow in FIG. 1;  
 FIG. 6 is a right-side elevational view of the back pillow in FIG. 1;  
 FIG. 7 is a front elevational view of the back pillow in FIG. 1; and,  
 FIG. 8 is a rear elevational view of the back pillow in FIG. 1.

- (56) **References Cited**  
U.S. PATENT DOCUMENTS
- |                |         |          |       |             |
|----------------|---------|----------|-------|-------------|
| D114,973 S *   | 5/1939  | Eckman   | ..... | 5/633       |
| 4,635,306 A *  | 1/1987  | Willey   | ..... | A47C 3/16   |
|                |         |          |       | 5/632       |
| 5,432,967 A *  | 7/1995  | Raftery  | ..... | A47C 16/005 |
|                |         |          |       | 5/633       |
| D406,718 S *   | 3/1999  | Jacobs   | ..... | D21/686     |
| 6,360,387 B1 * | 3/2002  | Everhart | ..... | A47C 20/027 |
|                |         |          |       | 5/490       |
| 6,643,874 B1 * | 11/2003 | Geglein  | ..... | A47C 1/146  |
|                |         |          |       | 297/181     |

**1 Claim, 8 Drawing Sheets**

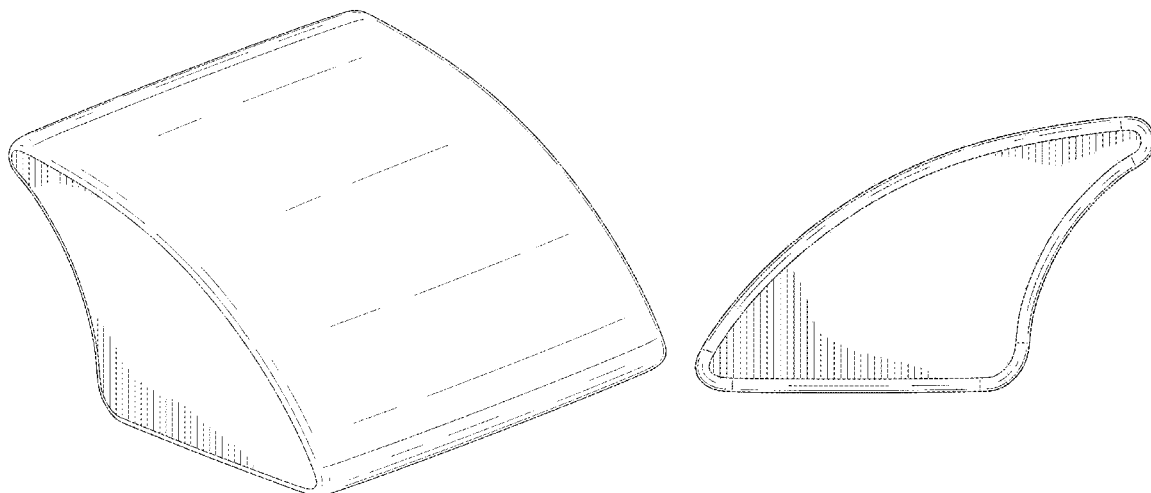

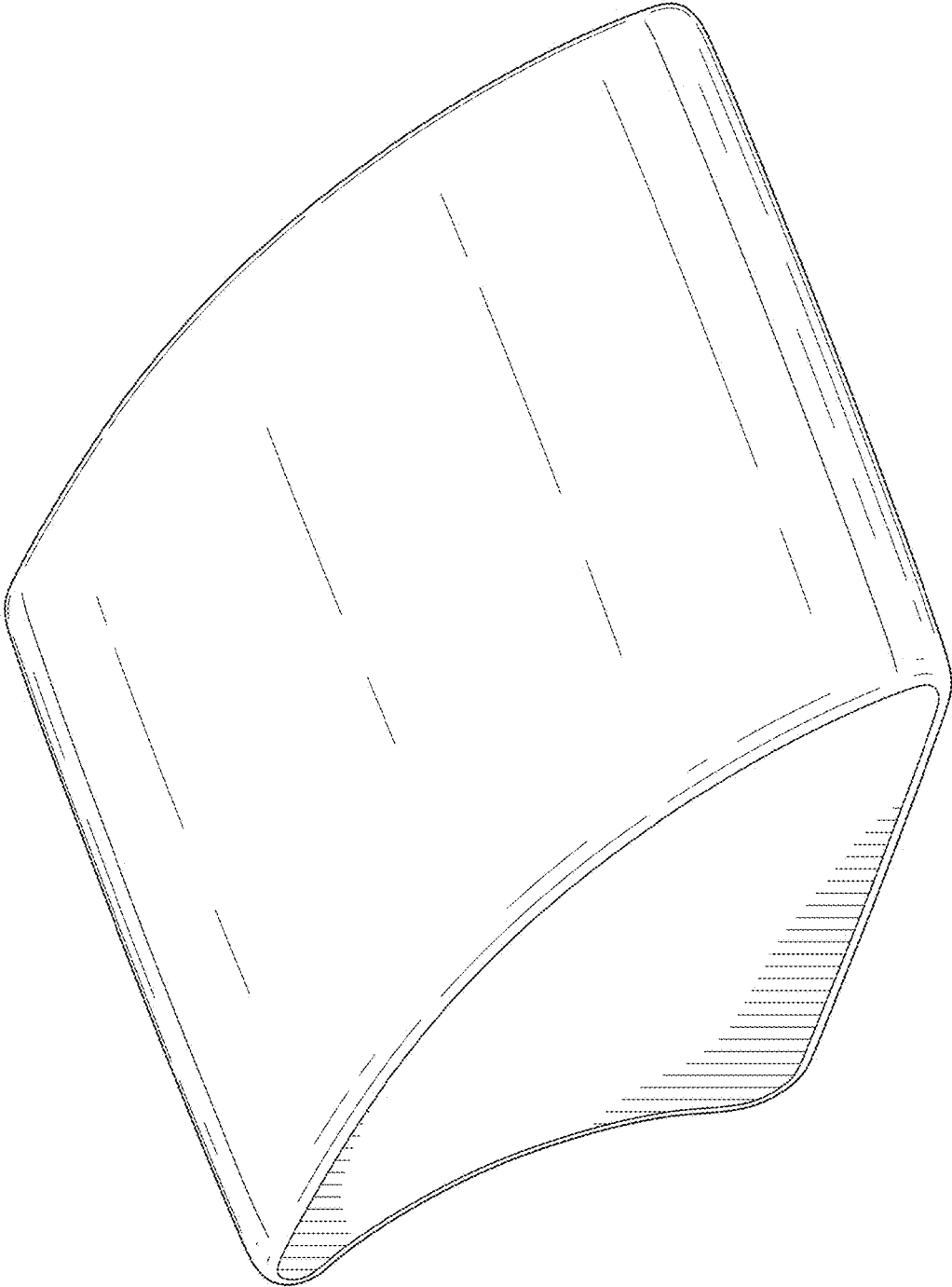

FIG. 1

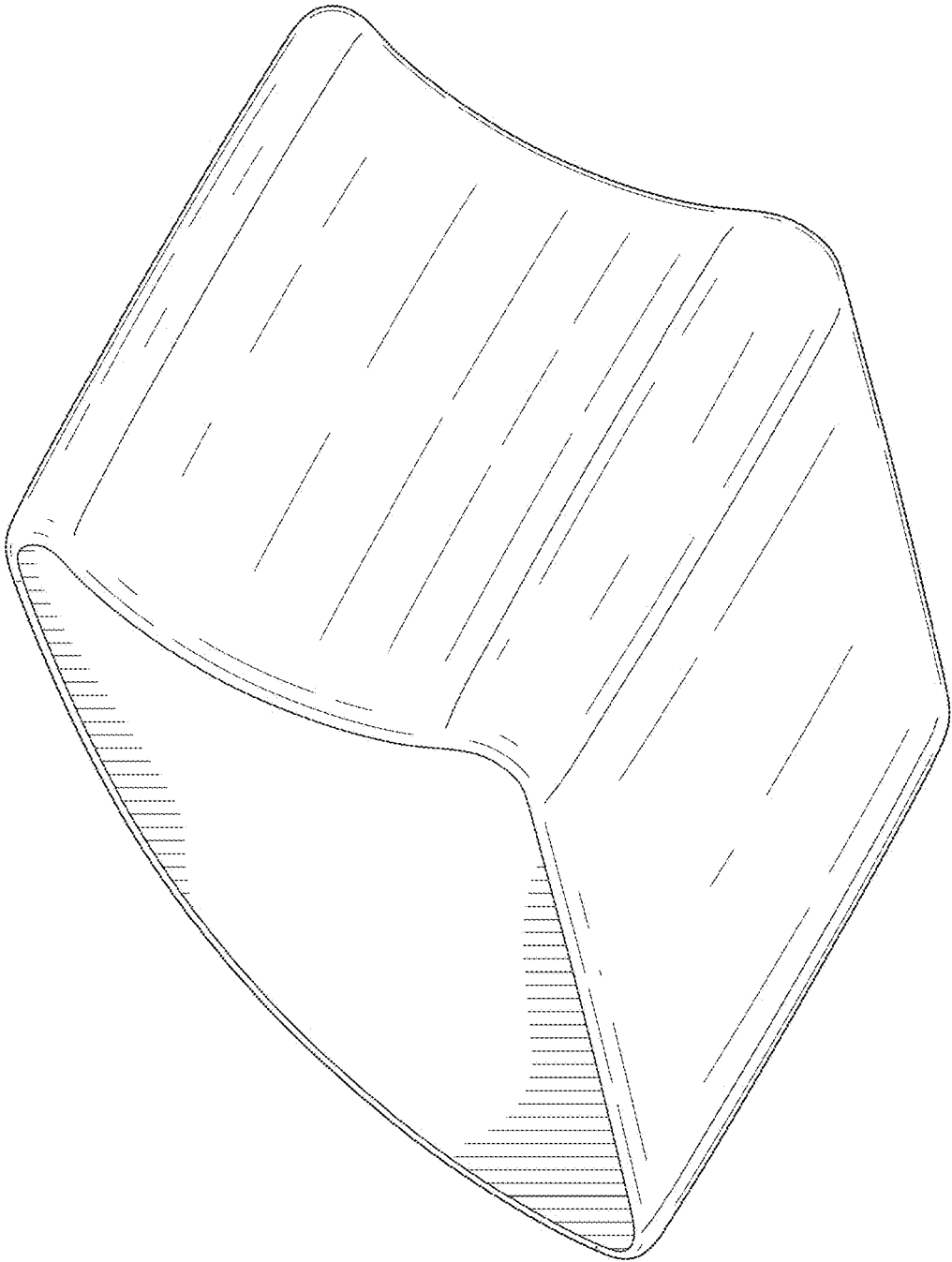

FIG. 2

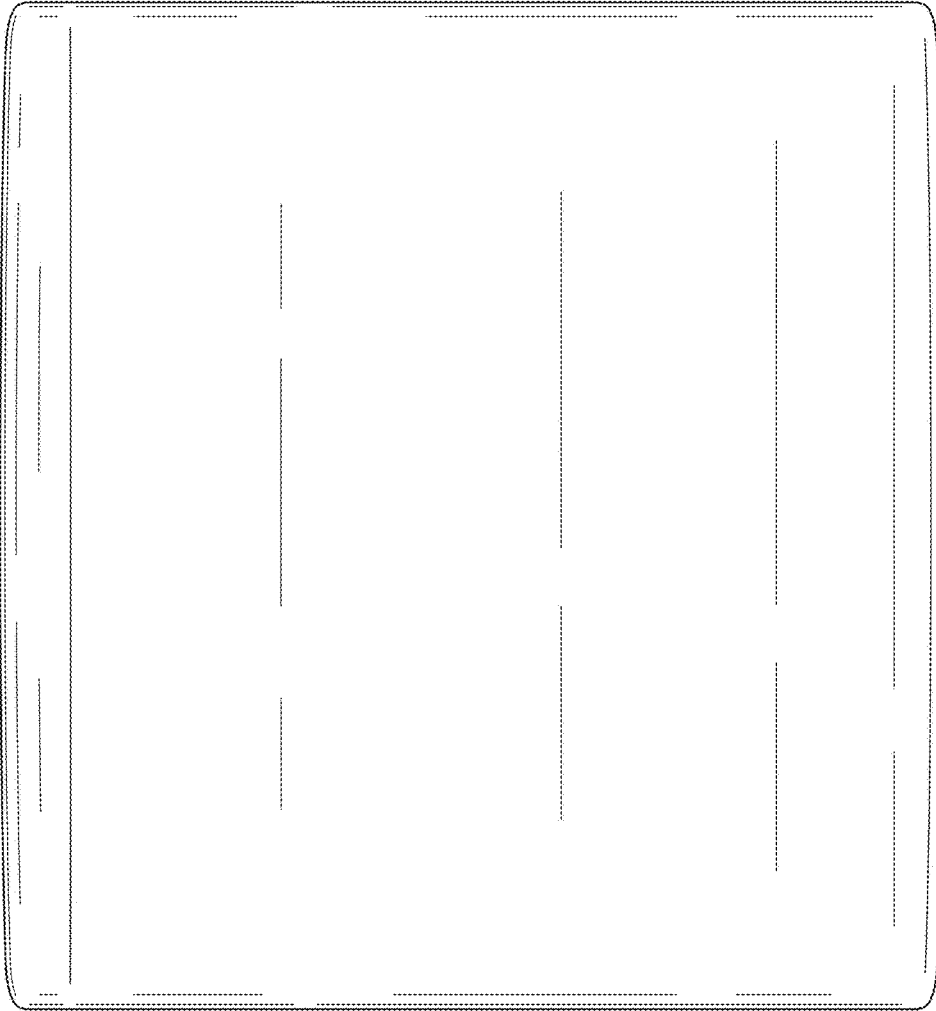

FIG. 3

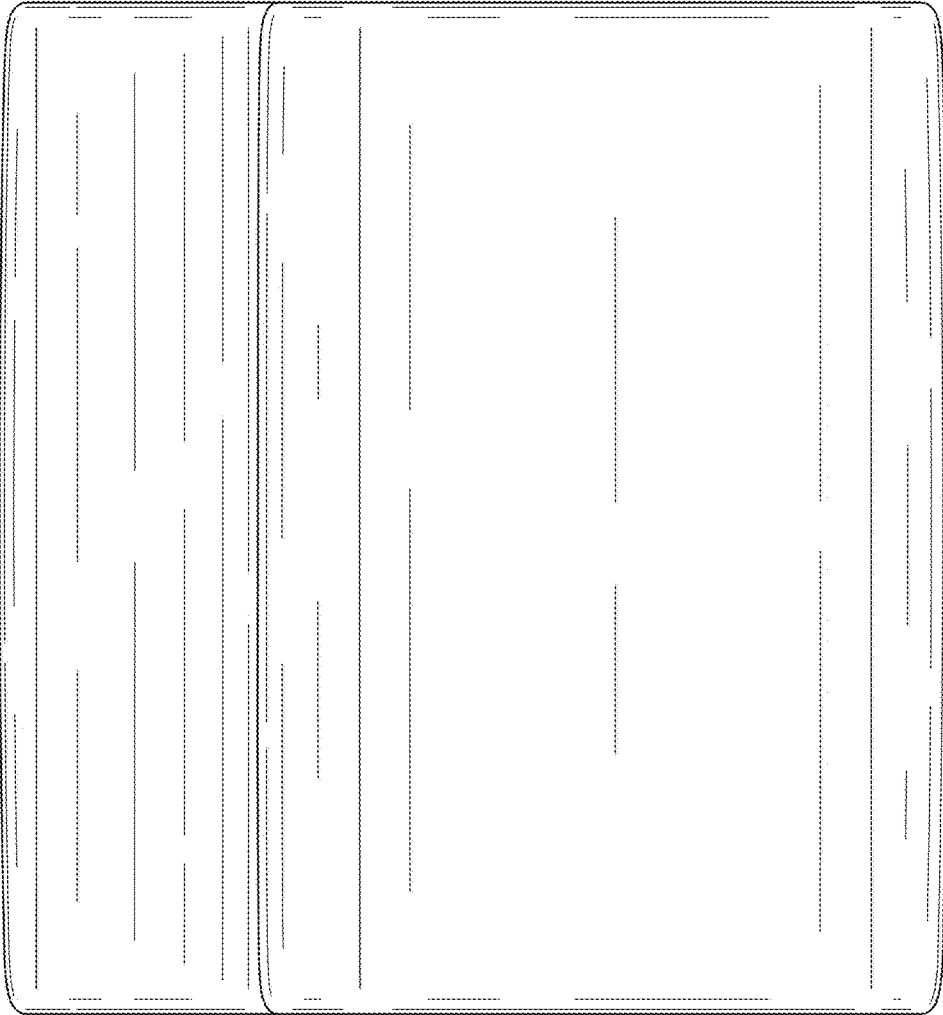

FIG. 4

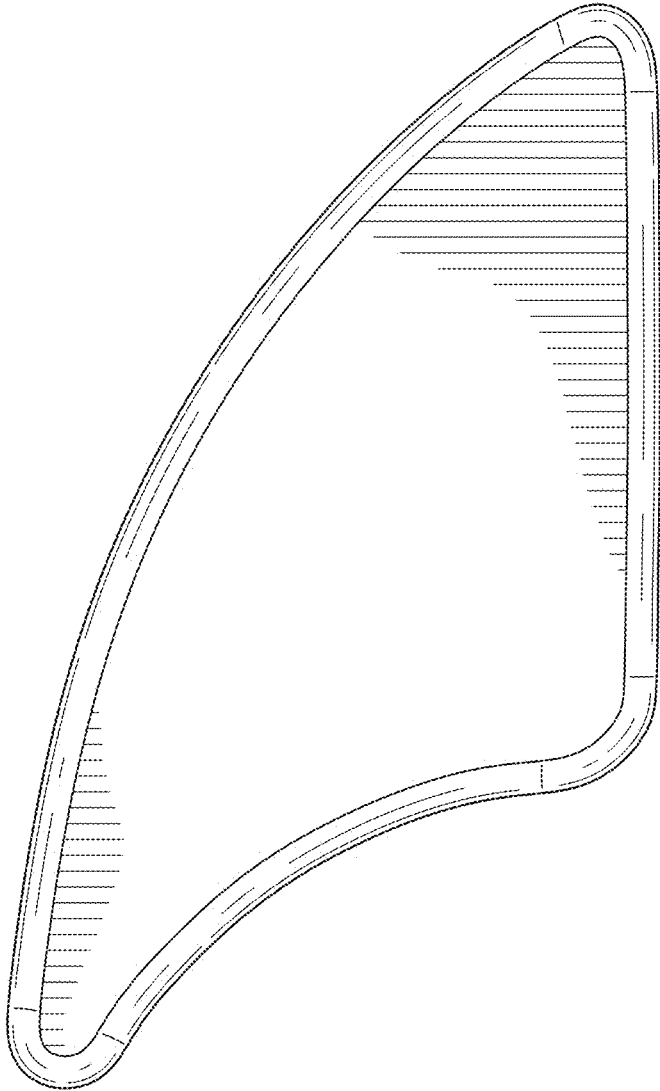

FIG. 5

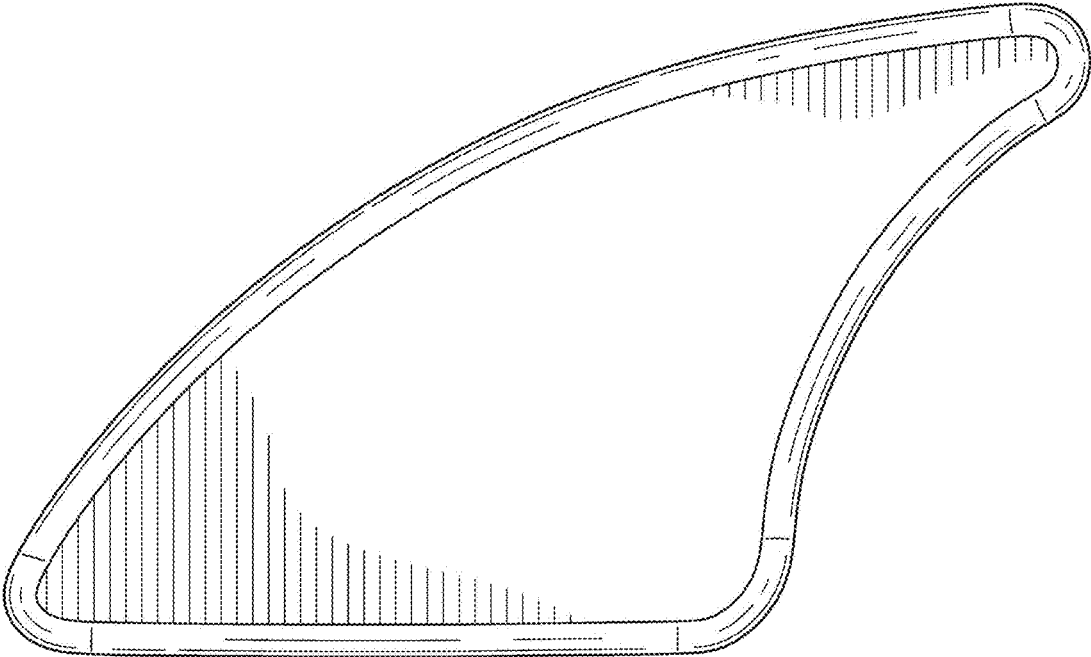

FIG. 6

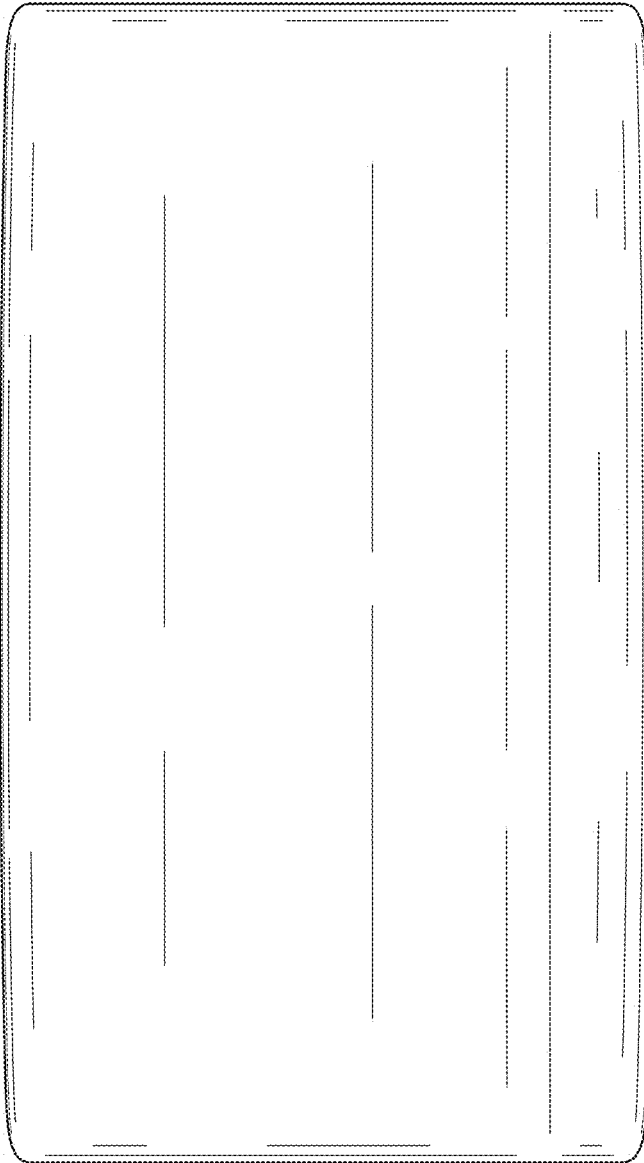

FIG. 7



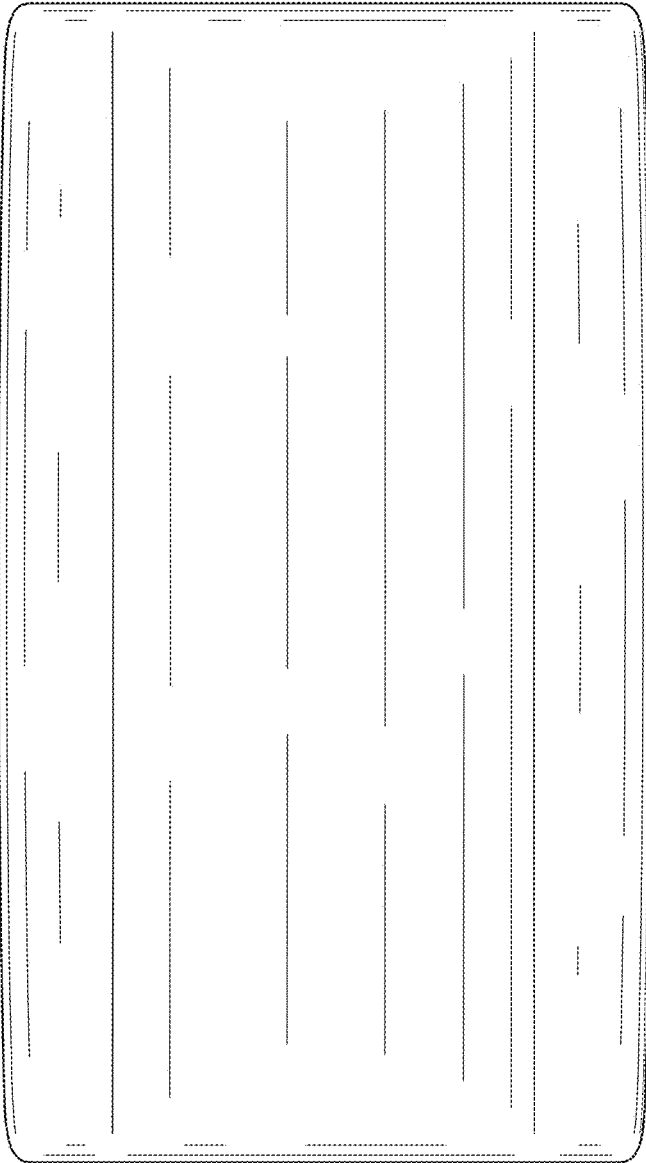

FIG. 8