

Fig. 1

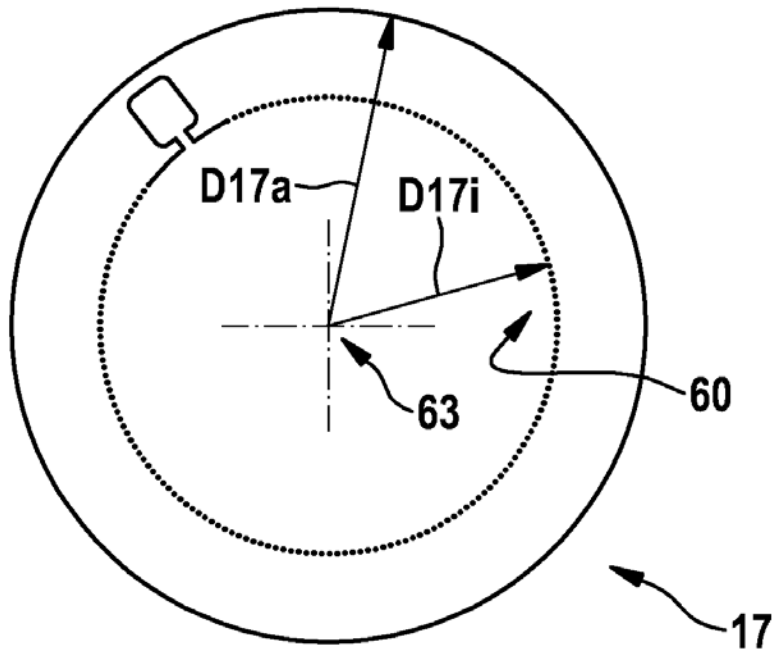

Fig. 2

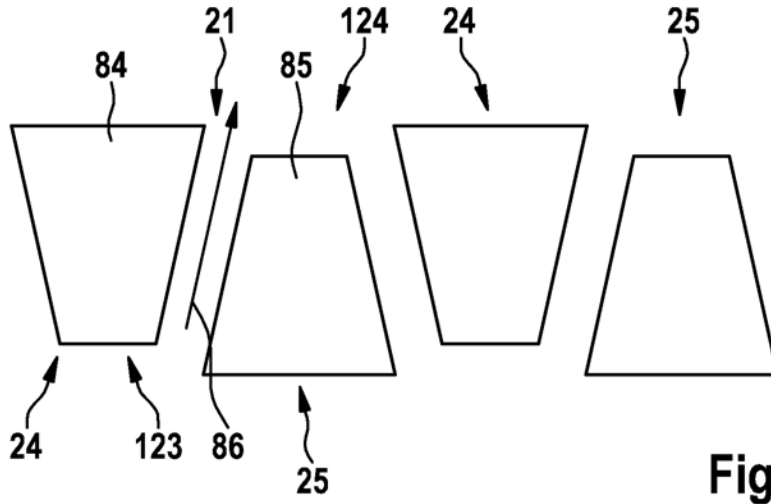

Fig. 3

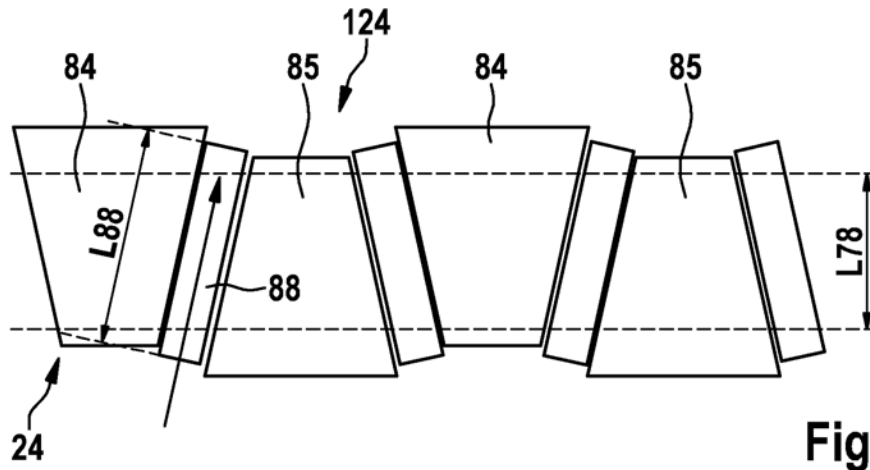

Fig. 4

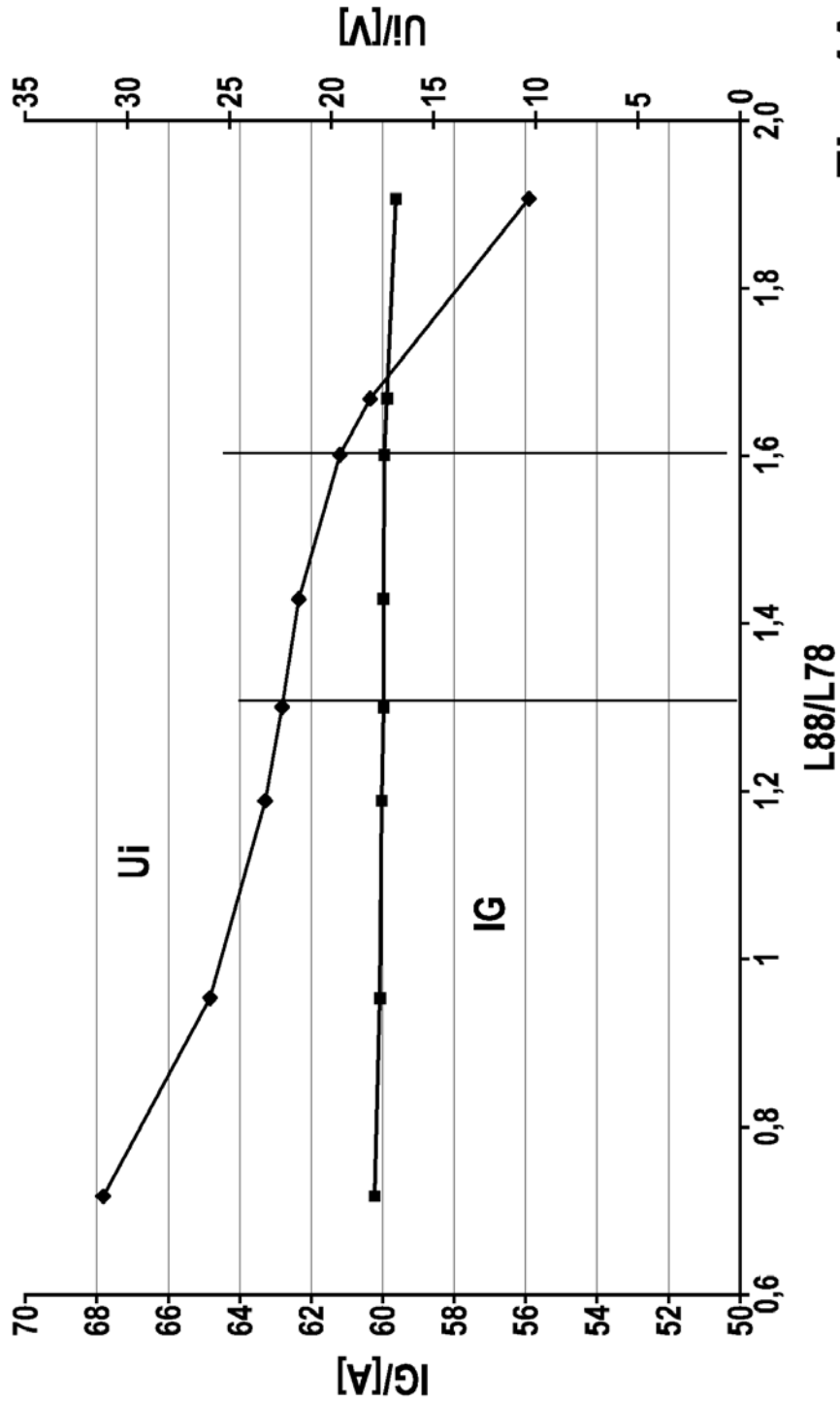

Fig. 4A

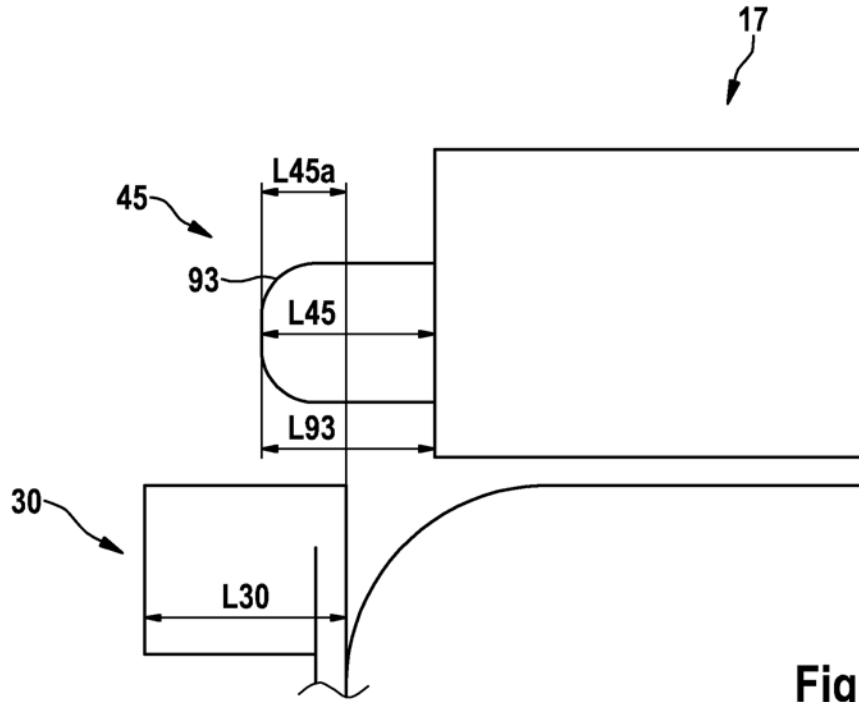

Fig. 5

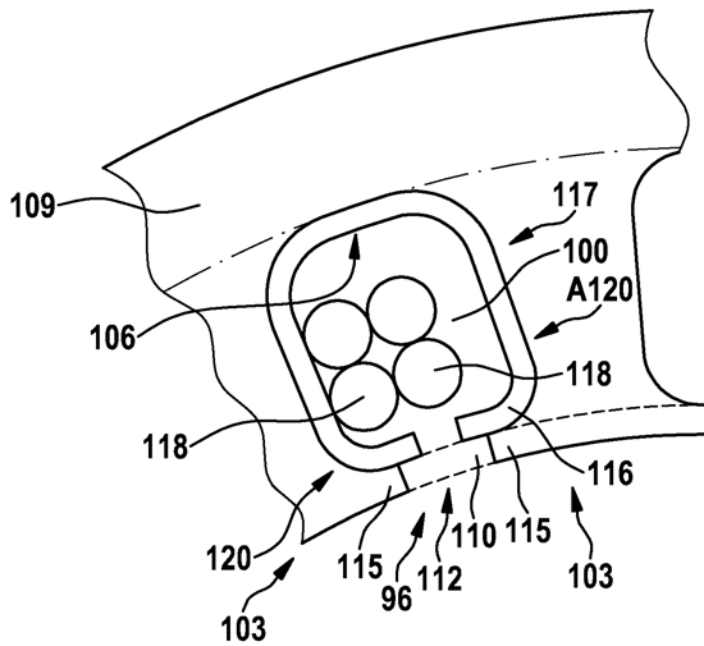

Fig. 6

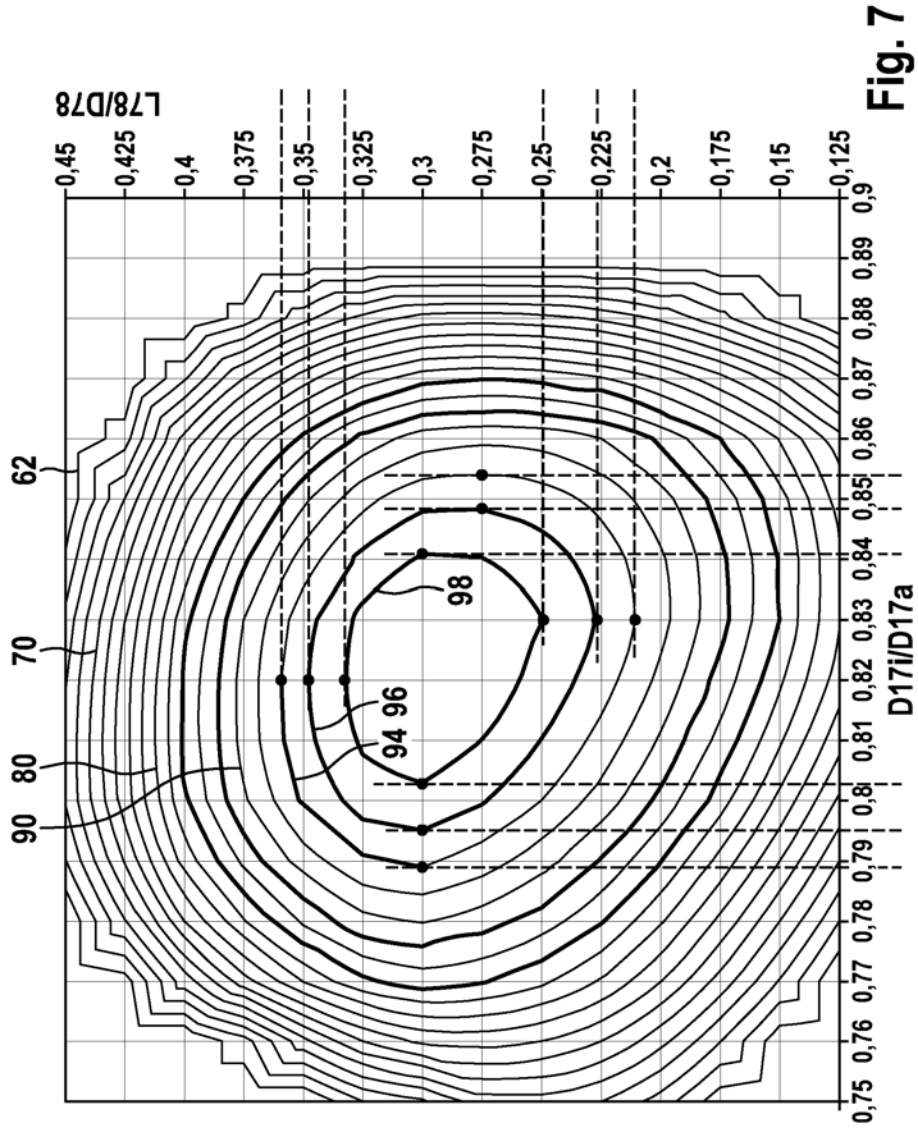

Fig. 7

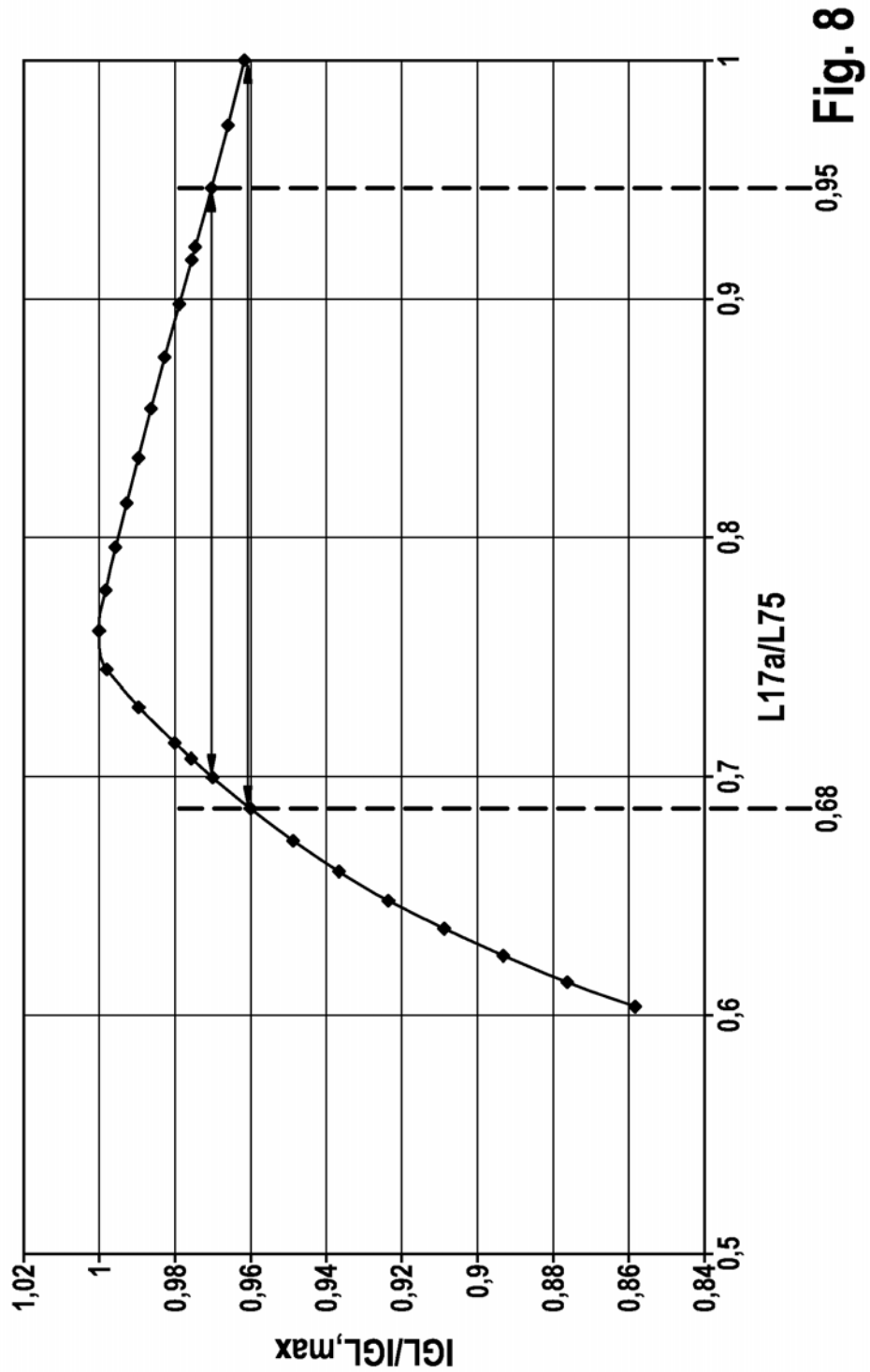

Fig. 8

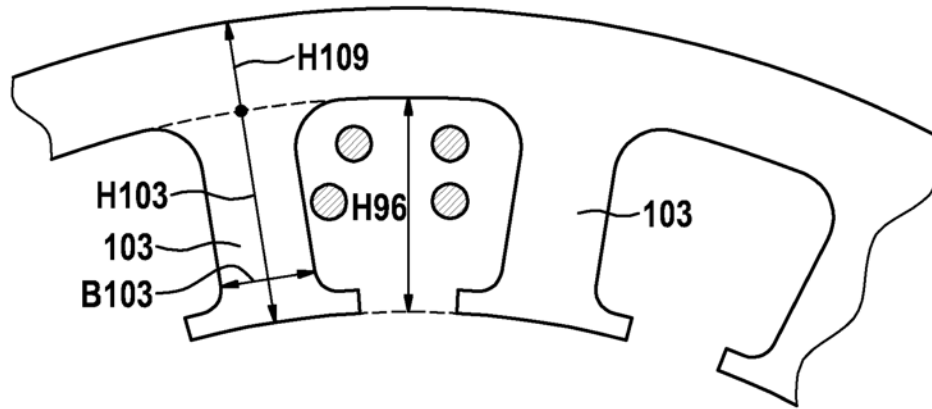

Fig. 9

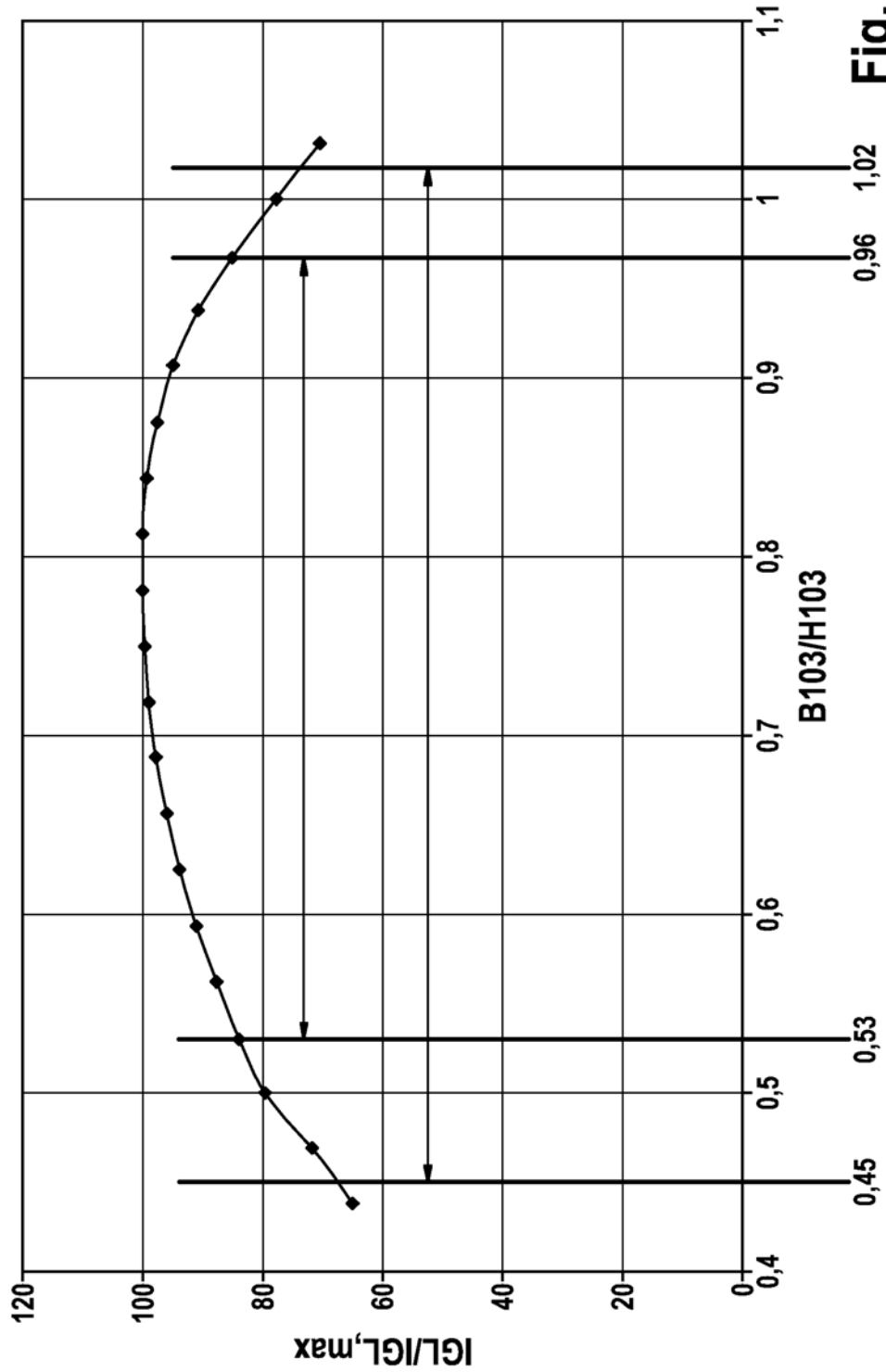

Fig. 10

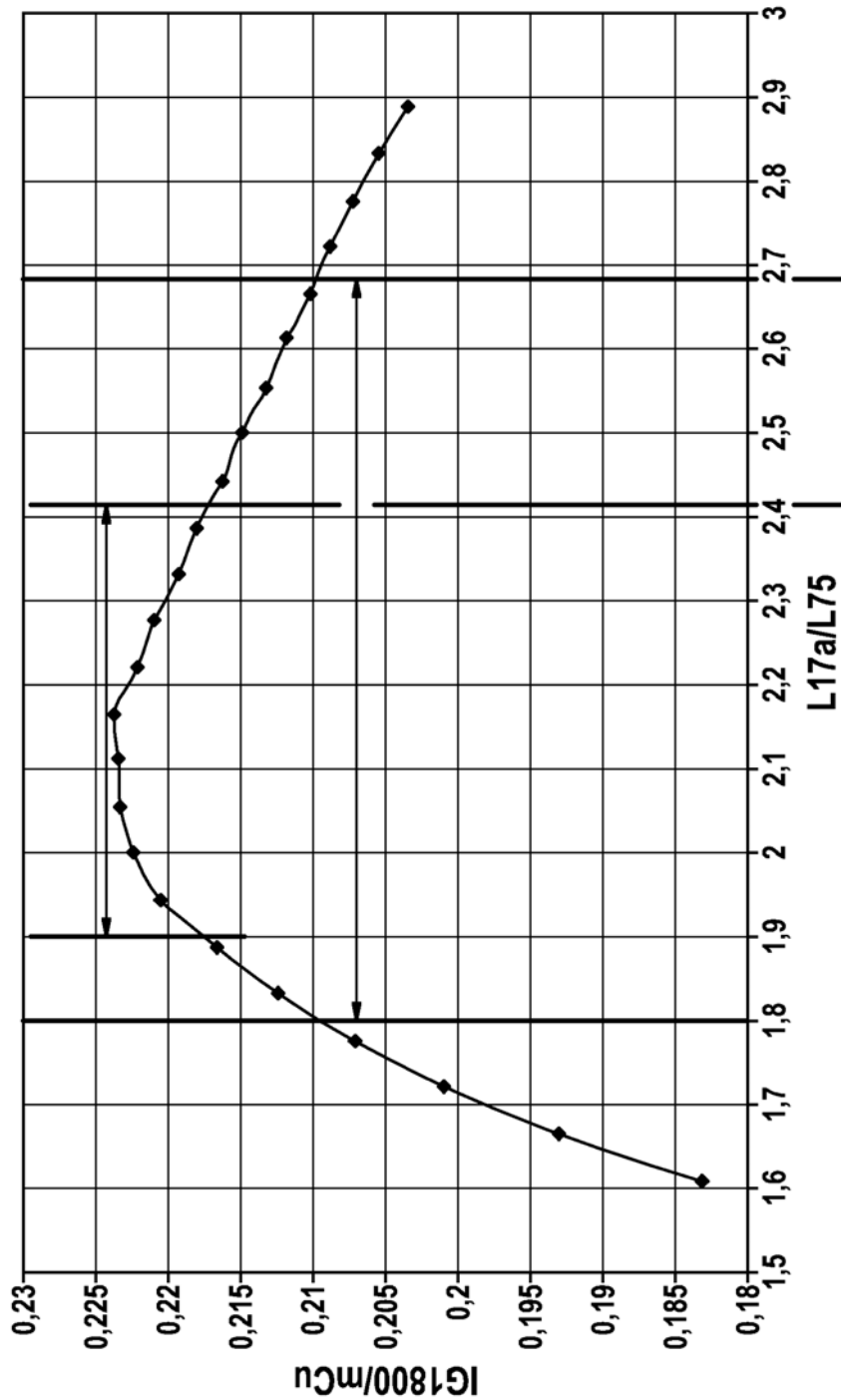

Fig. 11

PRASHANT PHILLIPS
IN/PA 1229
of Lakshmikumaran & Sridharan
Agent for the Applicant