



US00D475991S

(12) **United States Design Patent** (10) **Patent No.:** **US D475,991 S**
Hisatsune (45) **Date of Patent:** **** Jun. 17, 2003**

(54) **SPEAKER BOX**

D451,494 S 12/2001 Oikawa
D457,875 S * 5/2002 Joe D14/211

(75) Inventor: **Toshiyuki Hisatsune, Tokyo (JP)**

FOREIGN PATENT DOCUMENTS

(73) Assignee: **Sony Corporation, Tokyo (JP)**

JP 871343 6/1993
JP 872883 7/1993

(**) Term: **14 Years**

* cited by examiner

(21) Appl. No.: **29/162,631**

Primary Examiner—Nanda Bondade

(22) Filed: **Jun. 20, 2002**

(74) *Attorney, Agent, or Firm*—Rader, Fishman & Grauer PLLC

(51) **LOC (7) Cl.** **14-01**

(52) **U.S. Cl.** **D14/211**

(58) **Field of Search** D14/204, 207,
D14/209–216, 356; 181/144–145, 147–148,
150, 153, 157, 198–199; 381/300–302,
306, 333, 345, 361–364, 386–388

(57) **CLAIM**

The ornamental design for a speaker box, as shown.

(56) **References Cited**

U.S. PATENT DOCUMENTS

D229,565 S 12/1973 Légorju
D290,953 S * 7/1987 Sklaar et al. D14/211
D305,893 S 2/1990 Maloney
D381,988 S 8/1997 Ohba
D382,270 S 8/1997 Matsuoka
5,802,190 A * 9/1998 Ferren 381/386

DESCRIPTION

FIG. 1 is a perspective view of a speaker box showing my new design;
FIG. 2 is a front elevational view thereof;
FIG. 3 is a rear elevational view thereof;
FIG. 4 is a left side elevational view thereof;
FIG. 5 is a right side elevational view thereof;
FIG. 6 is a top plan view thereof; and,
FIG. 7 is a bottom plan view thereof.

1 Claim, 4 Drawing Sheets

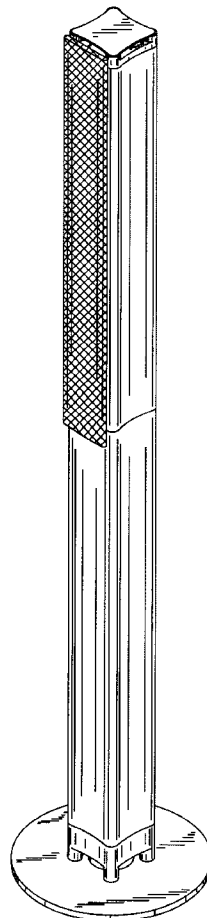

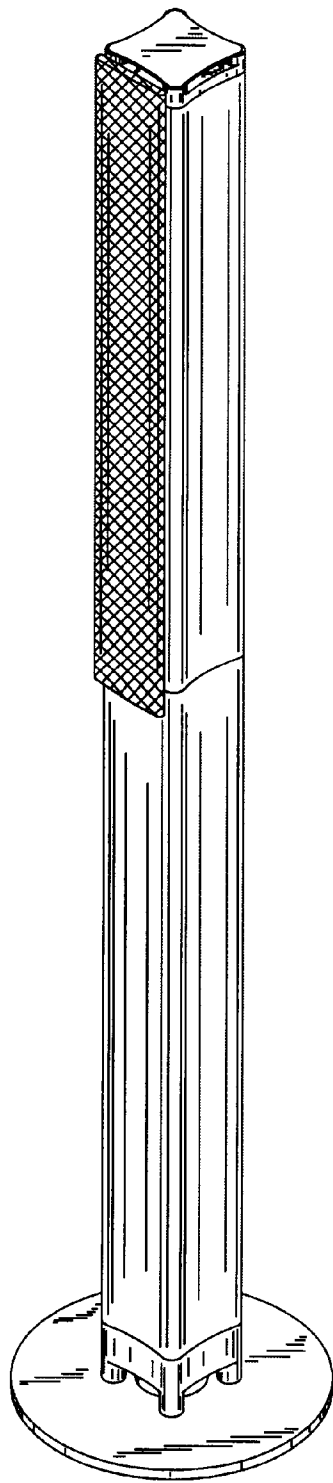

Fig. 1

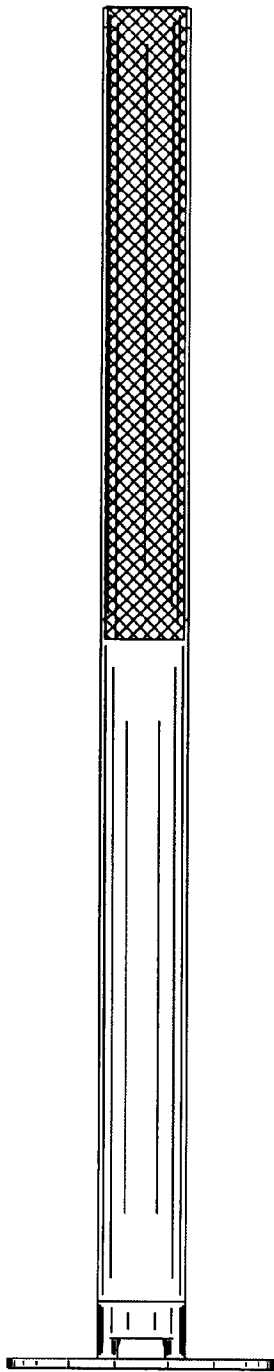

Fig. 2

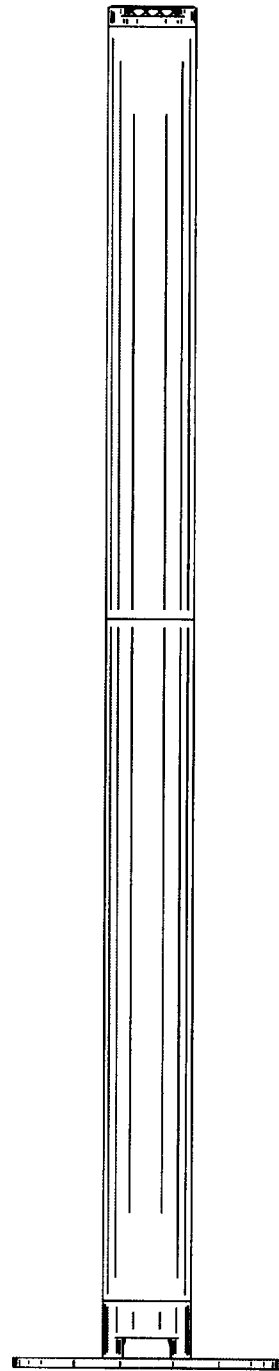

Fig. 3

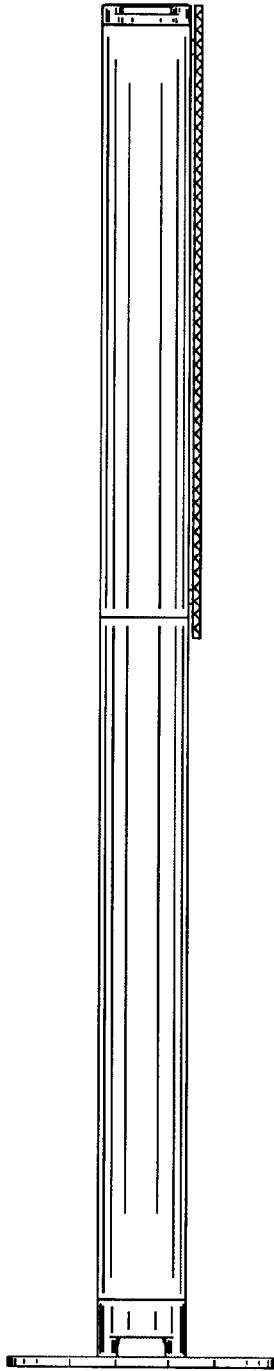

Fig. 4

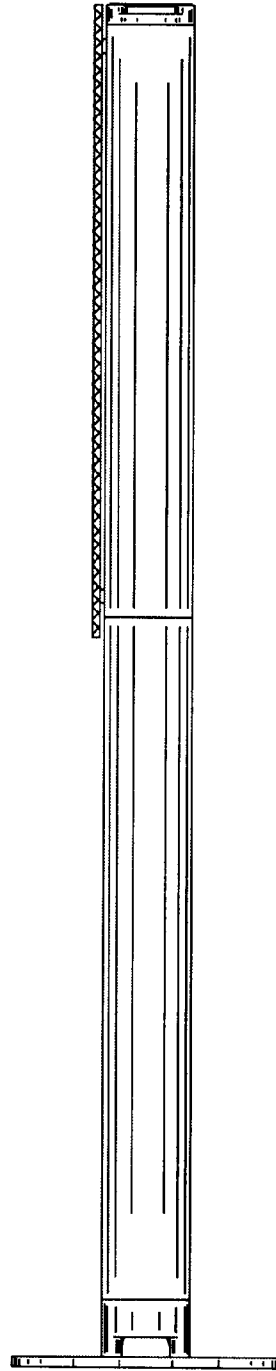

Fig. 5

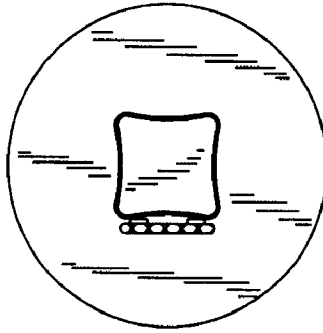

Fig. 6

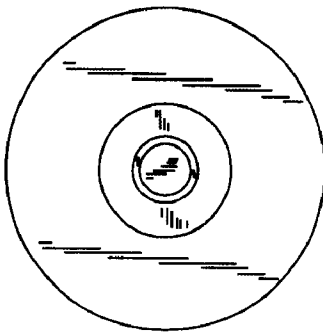

Fig. 7