



- (51) International Patent Classification:
G11C 11/00 (2006.01)
- (21) International Application Number:
PCT/CN2012/000314
- (22) International Filing Date:
13 March 2012 (13.03.2012)
- (25) Filing Language: English
- (26) Publication Language: English
- (71) Applicant (for all designated States except US): **MI-CRON TECHNOLOGY, INC.** [US/US]; 8000 S. Federal Way, Boise, Idaho 83716-9632 (US).
- (72) Inventor; and
- (75) Inventor/Applicant (for US only): **XU, Jun** [CN/CN]; No. 102, LN133, Shangwen Road, Shanghai 200010 (CN).
- (74) Agent: **LEE AND LI - LEAVEN IPR AGENCY LTD.**; Room 1008, Tower W1, Oriental Plaza, 1 East Chang An Avenue, Beijing 100738 (CN).
- (81) Designated States (unless otherwise indicated, for every kind of national protection available): AE, AG, AL, AM, AO, AT, AU, AZ, BA, BB, BG, BH, BR, BW, BY, BZ, CA, CH, CL, CN, CO, CR, CU, CZ, DE, DK, DM, DO,

DZ, EC, EE, EG, ES, FI, GB, GD, GE, GH, GM, GT, HN, HR, HU, ID, IL, IN, IS, JP, KE, KG, KM, KN, KP, KR, KZ, LA, LC, LK, LR, LS, LT, LU, LY, MA, MD, ME, MG, MK, MN, MW, MX, MY, MZ, NA, NG, NI, NO, NZ, OM, PE, PG, PH, PL, PT, QA, RO, RS, RU, RW, SC, SD, SE, SG, SK, SL, SM, ST, SV, SY, TH, TJ, TM, TN, TR, TT, TZ, UA, UG, US, UZ, VC, VN, ZA, ZM, ZW.

(84) Designated States (unless otherwise indicated, for every kind of regional protection available): ARIPO (BW, GH, GM, KE, LR, LS, MW, MZ, NA, RW, SD, SL, SZ, TZ, UG, ZM, ZW), Eurasian (AM, AZ, BY, KG, KZ, MD, RU, TJ, TM), European (AL, AT, BE, BG, CH, CY, CZ, DE, DK, EE, ES, FI, FR, GB, GR, HR, HU, IE, IS, IT, LT, LU, LV, MC, MK, MT, NL, NO, PL, PT, RO, RS, SE, SI, SK, SM, TR), OAPI (BF, BJ, CF, CG, CI, CM, GA, GN, GQ, GW, ML, MR, NE, SN, TD, TG).

Declarations under Rule 4.17:

— as to applicant's entitlement to apply for and be granted a patent (Rule 4.17(ii))

Published:

— with international search report (Art. 21(3))



WO 2013/134890 A1

(54) Title: NONCONSECUTIVE SENSING OF MULTILEVEL MEMORY CELLS

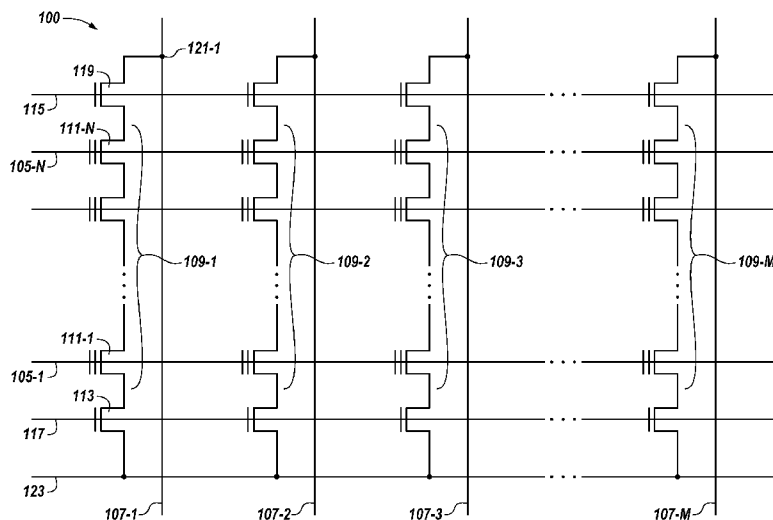

Fig. 1

(57) Abstract: The present disclosure includes apparatuses and methods for nonconsecutive sensing of multilevel memory cells. A number of methods include sensing a unit of information from a multilevel memory cell (MLC) using a sensing signal. The unit of information can correspond to a page of information. The MLC can store a plurality of units of information corresponding to a plurality of pages of information. The sensing signal can change from a first sensing magnitude to a second sensing magnitude and from the second sensing magnitude to a third sensing magnitude. The second sensing magnitude can be nonconsecutive from the first sensing magnitude and/or the third sensing magnitude can be nonconsecutive from the second sensing magnitude with respect to a plurality of sensing magnitudes corresponding to a plurality of charge storage states of the MLC.

NONCONSECUTIVE SENSING OF MULTILEVEL MEMORY CELLS

Technical Field

[0001] The present disclosure relates generally to semiconductor memory and methods, and more particularly, to apparatuses and methods for nonconsecutive sensing of multilevel memory cells.

Background

[0002] Memory devices are typically provided as internal, semiconductor, integrated circuits in computers or other electronic devices. There are many different types of memory including volatile and non-volatile memory. Volatile memory can require power to maintain its information (e.g., data, error information, etc.) and includes random-access memory (RAM), dynamic random access memory (DRAM), and synchronous dynamic random access memory (SDRAM), among others. Non-volatile memory can provide persistent information by retaining stored information when not powered and can include NAND flash memory, NOR flash memory, read only memory (ROM), Electrically Erasable Programmable ROM (EEPROM), Erasable Programmable ROM (EPROM), and resistance variable memory such as phase change random access memory (PCRAM), resistive random access memory (RRAM), and magnetoresistive random access memory (MRAM), among others.

[0003] Memory devices can be combined together to form a solid state drive (SSD). A solid state drive can include non-volatile memory (e.g., NAND flash memory and NOR flash memory) and/or can include volatile memory (e.g., DRAM and SRAM) among various other types of non-volatile and volatile memory. Flash memory devices can include a charge storage structure, such as is included in floating gate flash devices and charge trap flash (CTF) devices, which may be utilized as non-volatile memory for a wide range of electronic applications. Flash memory devices may use a one-transistor memory cell that allows for high memory densities, high reliability, and low power consumption.

[0004] Memory cells in an array architecture can be programmed to a target charge storage state. For example, electric charge can be placed on or removed from the floating gate of a memory cell to put the cell into one of a number of charge storage states. For example, a single level cell (SLC) can be

programmed to one of two charge storage states representing one of two units of information (e.g., 1 or 0). Multilevel memory cells (MLCs) can be programmed to one of more than two charge storage states. For example, an MLC capable of storing two units of information can be programmed to one of four charge storage states, an MLC capable of storing three units of information can be programmed to one of eight charge storage states, and an MLC capable of storing four units of information can be programmed to one of sixteen charge storage states. MLCs can allow the manufacture of higher density memories without increasing the number of memory cells since each cell can represent more than one unit of information, e.g., more than one bit. However, storing an increasing number of units of information in an MLC may increase a sensing time to resolve the stored units of information.

Brief Description of the Drawings

[0005] Figure 1 illustrates a schematic diagram of a portion of a non-volatile memory array in accordance with a number of embodiments of the present disclosure.

[0006] Figure 2 illustrates a block diagram of an apparatus in the form of a computing system including at least one memory system in accordance with a number of embodiments of the present disclosure.

[0007] Figure 3A illustrates a diagram of charge storage states and sensing magnitudes for a multilevel memory cell in accordance with a number of embodiments of the present disclosure.

[0008] Figure 3B illustrates a diagram of a sensing signal for a multilevel memory cell according to some previous approaches.

[0009] Figure 3C illustrates a diagram of a sensing signal for a multilevel memory cell according to some previous approaches.

[0010] Figure 4A illustrates a diagram of a first sensing signal for a multilevel memory cell in accordance with a number of embodiments of the present disclosure.

[0011] Figure 4B illustrates a diagram of a second sensing signal for the multilevel memory cell in accordance with a number of embodiments of the present disclosure.

[0012] Figure 4C illustrates a diagram of a third sensing signal for the multilevel memory cell in accordance with a number of embodiments of the present disclosure.

[0013] Figure 5 illustrates a diagram of a scheme for correlating units of information with charge storage states of a multilevel memory cell in accordance with a number of embodiments of the present disclosure.

[0014] Figure 6A illustrates a diagram of a first sensing signal for a multilevel memory cell in accordance with a number of embodiments of the present disclosure.

[0015] Figure 6B illustrates a diagram of a second sensing signal for the multilevel memory cell in accordance with a number of embodiments of the present disclosure.

[0016] Figure 7 illustrates a diagram of a scheme for correlating units of information with charge storage states of a number of multilevel memory cells in accordance with a number of embodiments of the present disclosure.

Detailed Description

[0017] The present disclosure includes apparatuses and methods for nonconsecutive sensing of multilevel memory cells. A number of methods include sensing a unit of information from a multilevel memory cell (MLC) using a sensing signal. The unit of information can correspond to a page of information. The MLC can store a plurality of units of information corresponding to a plurality of pages of information. The sensing signal can change from a first sensing magnitude to a second sensing magnitude and from the second sensing magnitude to a third sensing magnitude. The second sensing magnitude can be nonconsecutive from the first sensing magnitude and/or the third sensing magnitude can be nonconsecutive from the second sensing magnitude with respect to a plurality of sensing magnitudes corresponding to a plurality of charge storage states of the MLC.

[0018] Some previous approaches to sensing MLCs have included increasing a magnitude of a sensing signal and allowing it to settle at a sensing magnitude between each of the charge storage states of the MLC. Such previous approaches can be time-intensive, particularly for MLCs that can be programmed to a large number of charge storage states. In contrast, a number of

embodiments of the present disclosure can read information (e.g., a page of information, or a portion thereof) from an MLC by changing a magnitude of a sensing signal through less than all of the sensing magnitudes between charge storage states, thereby reducing an amount of time that would otherwise be used to sense the MLC.

[0019] In the following detailed description of the present disclosure, reference is made to the accompanying drawings that form a part hereof, and in which is shown by way of illustration how one or more embodiments of the disclosure may be practiced. These embodiments are described in sufficient detail to enable those of ordinary skill in the art to practice the embodiments of this disclosure, and it is to be understood that other embodiments may be utilized and that process, electrical, and/or structural changes may be made without departing from the scope of the present disclosure. As used herein, the designator “N”, particularly with respect to reference numerals in the drawings, indicates that a number of the particular feature so designated can be included. As used herein, “a number of” a particular thing can refer to one or more of such things (e.g., a number of memory devices can refer to one or more memory devices).

[0020] The figures herein follow a numbering convention in which the first digit or digits correspond to the drawing figure number and the remaining digits identify an element or component in the drawing. Similar elements or components between different figures may be identified by the use of similar digits. For example, 516 may reference element “16” in Figure 5, and a similar element may be referenced as 716 in Figure 7. As will be appreciated, elements shown in the various embodiments herein can be added, exchanged, and/or eliminated so as to provide a number of additional embodiments of the present disclosure. In addition, as will be appreciated, the proportion and the relative scale of the elements provided in the figures are intended to illustrate certain embodiments of the present invention, and should not be taken in a limiting sense.

[0021] Figure 1 illustrates a schematic diagram of a portion of a non-volatile memory array 100 in accordance with a number of embodiments of the present disclosure. The embodiment of Figure 1 illustrates a NAND architecture non-volatile memory array. However, embodiments described herein are not

limited to this example. As shown in Figure 1, the memory array 100 includes access lines (e.g., word lines 105-1, . . . , 105-N) and intersecting data lines, e.g., local bit lines 107-1, 107-2, 107-3, . . . , 107-M. For ease of addressing in the digital environment, the number of word lines 105-1, . . . , 105-N and the number of local bit lines 107-1, 107-2, 107-3, . . . , 107-M can be some power of two, e.g., 256 word lines by 4,096 bit lines.

[0022] Memory array 100 includes NAND strings 109-1, 109-2, 109-3, . . . , 109-M. Each NAND string includes non-volatile memory cells 111-1, . . . , 111-N, each communicatively coupled to a respective word line 105-1, . . . , 105-N. Each NAND string (and its constituent memory cells) is also associated with a local bit line 107-1, 107-2, 107-3, . . . , 107-M. The memory cells 111-1, . . . , 111-N of each NAND string 109-1, 109-2, 109-3, . . . , 109-M are connected in series source to drain between a source select gate (SGS) (e.g., a field-effect transistor (FET) 113) and a drain select gate (SGD) (e.g., FET 119). Each source select gate 113 is configured to selectively couple a respective NAND string to a common source 123 responsive to a signal on source select line 117, while each drain select gate 119 is configured to selectively couple a respective NAND string to a respective bit line responsive to a signal on drain select line 115.

[0023] As shown in the embodiment illustrated in Figure 1, a source of source select gate 113 is connected to a common source line 123. The drain of source select gate 113 is connected to the source of the memory cell 111-1 of the corresponding NAND string 109-1. The drain of drain select gate 119 is connected to bit line 107-1 of the corresponding NAND string 109-1 at drain contact 121-1. The source of drain select gate 119 is connected to the drain of the last memory cell 111-N (e.g., a floating-gate transistor) of the corresponding NAND string 109-1.

[0024] In a number of embodiments, construction of the non-volatile memory cells 111-1, . . . , 111-N includes a source, a drain, a floating gate or other charge storage structure, and a control gate. The memory cells 111-1, . . . , 111-N have their control gates coupled to a word line, 105-1, . . . , 105-N, respectively. A NOR array architecture would be similarly laid out, except that the string of memory cells would be coupled in parallel between the select gates. Furthermore, a NOR architecture can provide for random access (e.g., sensing)

to the memory cells in the array (e.g., as opposed to page-based access as with a NAND architecture).

[0025] A number (e.g., a subset or all) of cells coupled to a selected word line (e.g., 105-1, . . . , 105-N) can be programmed and/or sensed (e.g., read) together as a group. A number of cells programmed and/or sensed together can correspond to a page of information. In association with a sensing operation, a number of cells coupled to a particular word line and programmed together to respective charge storage states can be referred to as a target page. A programming operation (e.g., a write operation) can include applying a number of program pulses (e.g., 16V-20V) to a selected word line in order to increase the threshold voltage (V_t) of selected cells coupled to that selected access line to a desired program voltage level corresponding to a targeted charge storage state.

[0026] A sensing operation, such as a read or program verify operation, can include sensing a voltage and/or current change of a bit line coupled to a selected cell in order to determine the charge storage state of the selected cell. The sensing operation can include precharging a bit line and sensing the discharge when a selected cell begins to conduct.

[0027] Sensing the charge storage state of a selected cell can include providing a number of sensing signals (e.g., read voltages) to a selected word line while providing a number of voltages (e.g., read pass voltages) to the word lines coupled to the unselected cells of the string sufficient to place the unselected cells in a conducting state independent of the threshold voltage of the unselected cells. The bit line corresponding to the selected cell being read and/or verified can be sensed to determine whether or not the selected cell conducts in response to the particular sensing signal applied to the selected word line. For example, the charge storage state of a selected cell can be determined by the word line voltage at which the bit line current reaches a particular reference current associated with a particular state.

[0028] Figure 2 illustrates a block diagram of an apparatus in the form of a computing system 201 including at least one memory system 204 in accordance with a number of embodiments of the present disclosure. As used herein, a memory system 204, a controller 208, or a memory device 210 might also be separately considered an “apparatus.” The memory system 204 can be a solid state drive (SSD), for instance, and can include a host interface 206, a

controller 208 (e.g., a processor and/or other control circuitry), and a number of memory devices 210-1, . . . , 210-N (e.g., solid state memory devices such as NAND flash devices), which provide a storage volume for the memory system 204.

[0029] As illustrated in Figure 2, the controller 208 can be coupled to the host interface 206 and to the memory devices 210-1, . . . , 210-N via a plurality of channels and can be used to transfer information between the memory system 204 and a host 202. The interface 206 can be in the form of a standardized interface. For example, when the memory system 204 is used for information storage in a computing system 201, the interface 206 can be a serial advanced technology attachment (SATA), peripheral component interconnect express (PCIe), or a universal serial bus (USB), among other connectors and interfaces. In general, however, interface 206 can provide an interface for passing control, address, information, and other signals between the memory system 204 and a host 202 having compatible receptors for the interface 206.

[0030] Host 202 can be a host system such as a personal laptop computer, a desktop computer, a digital camera, a mobile telephone, or a memory card reader, among various other types of hosts. Host 202 can include a system motherboard and/or backplane and can include a number of memory access devices (e.g., a number of processors).

[0031] The controller 208 can communicate with the memory devices 210-1, . . . , 210-N to control information read, write, and erase operations, among other operations. Although not specifically illustrated, in some embodiments, the controller 208 can include a discrete memory channel controller for each channel coupling the controller 208 to the memory devices 210-1, . . . , 210-N. The controller 208 can include, for example, a number of components in the form of hardware and/or firmware (e.g., one or more integrated circuits) and/or software for controlling access to the number of memory devices 210-1, . . . , 210-N and/or for facilitating information transfer between the host 202 and memory devices 210-1, . . . , 210-N. The controller 208 can be configured to perform the operations described herein.

[0032] In some embodiments, and as illustrated in Figure 2, the controller 208 can include a sensing signal generator 212. The sensing signal generator 212 can be a discrete component or can reflect functionality provided

by circuitry within the controller 208 that does not necessarily have a discrete physical form separate from other portions of the controller 208. Although illustrated as a component within the controller 208 in Figure 2, the sensing signal generator 212 can be external to the controller 208 or have a number of components located within the controller 208 and a number of components located external to the controller 208.

[0033] The memory devices 210-1, . . . , 210-N can include a number of arrays of memory cells (e.g., non-volatile memory cells). The arrays can be flash arrays with a NAND architecture, for example. However, embodiments are not limited to a particular type of memory array or array architecture. The memory cells can be grouped, for instance, into a number of blocks including a number of physical pages. A number of blocks can be included in a plane of memory cells and an array can include a number of planes. As one example, a memory device may be configured to store 8KB (kilobytes) of user data per page, 128 pages of user data per block, 2048 blocks per plane, and 16 planes per device.

[0034] In operation, information can be written to and/or read from a memory device of a memory system (e.g., memory devices 210-1, . . . , 210-N of system 204) as a page of information, for example. As such, a page of information can be referred to as an information transfer size of the memory system. Information can be transferred to/from a host (e.g., host 202) in information segments referred to as sectors (e.g., host sectors). As such, a sector of information can be referred to as an information transfer size of the host.

[0035] Although a page of information can include a number of bytes of user data (e.g., a data payload including a number of sectors of data) as well as metadata corresponding thereto, a size of a page of information often can refer only to the number of bytes of the user data. As an example, a page of information having a page size of 4KB may include 4KB of user data (e.g., 8 sectors assuming a sector size of 512B) as well as a number of bytes (e.g., 32B, 54B, 224B, etc.) of metadata corresponding to the user data. The metadata can include integrity data such as error data (e.g., error detecting and/or correcting code data) and/or address data (e.g., logical address data), among other metadata corresponding to the user data.

[0036] In a number of embodiments, the controller 208 can be configured to change a magnitude of an output of the sensing signal generator 212 serially through each of a first subset of a plurality of sensing magnitudes to read a first page of information from a number of MLCs in an array of memory cells (e.g., in a number of the memory devices 210-1, . . . , 210-N). The plurality of sensing signal magnitudes can include any number (e.g., seven) of different magnitudes. A subset of the plurality of sensing signal magnitudes can include any number less than the plurality of different magnitudes (e.g., one, three, etc.). Changing the output of the sensing signal generator serially through the subset can include changing the output in the order of the subset. For example, a subset of seven sensing signal magnitudes (e.g., R1-R7) can include three sensing signal magnitudes (e.g., R1, R3, and R6). Changing the output serially through the subset can include changing the output from R1 to R3 to R6, in this example. Thus, the output can be serial with respect to the subset, however it may not be consecutive with respect to a plurality of charge storage states of the MLC and/or the overall plurality of sensing magnitudes (e.g., R1, R2, R3, R4, R5, R6, and R7) in that the output of the sensing signal generator 212 may not be allowed to settle on (e.g., may skip) some of the sensing signal magnitudes (e.g., R2, R4, R5, and R7). The controller 208 can be configured to change the magnitude of the output of the sensing signal generator 212 serially through each of a second subset (or a third subset, fourth subset, etc.) of the plurality of sensing magnitudes to read a second page (or a third page, a fourth page, etc.) of information from the number of MLCs in the array. Each of the plurality of sensing magnitudes can correspond to a respective charge storage state for the number of MLCs. Such examples are described in more detail below with respect to Figures 4A-7.

[0037] The controller 208 can be configured to read respective pages of information in response to respective commands (e.g., commands received from the host 202). For example, the controller 208 can be configured to read a first page of information in response to a first command and to read a second page of information in response to a second command. Pages of information can include host data and/or error correction information (e.g., ECC data), among other information. In some embodiments, a number of pages of information can be read from an MLC storing at least a portion of a plurality of pages of information

without reading all of the pages of information. In a number of embodiments, the controller 208 can be configured to read more than one (e.g., a first and a second) page of information in response to a single command. In various embodiments, a page of information can be stored as a non-integer number of units of information in each of a number of MLCs (e.g., fractional-bit memory cells).

[0038] Figure 3A illustrates a diagram of charge storage states and sensing magnitudes for a multilevel memory cell in accordance with a number of embodiments of the present disclosure. Memory cells of an array can be single level cells (SLCs) or multi-level cells (MLCs). SLCs can be single-unit (e.g., two-state) memory cells. That is, the cells can be programmed to one of two charge storage states (e.g., L0 and L1, respectively). In operation, a number of memory cells can be programmed such that they have a charge storage (e.g., threshold voltage (V_t)) level corresponding to either L0 or L1. With respect to SLCs, for instance, charge storage state L0 can represent a stored information value such as binary “1,” while charge storage state L1 can represent a stored information value such as binary “0”.

[0039] MLCs can be two-unit (e.g., four-state), 2.25-unit (e.g., five-state), 2.5-unit (e.g., six-state), 2.75-unit (e.g., seven-state), three-unit (e.g., eight-state), or four-unit (e.g., sixteen state) memory cells, among other numbers of units of information. For instance, a two-unit memory cell can be programmed to one of four charge storage states (e.g., L0, L1, L2, L3), respectively. A three-unit memory cell can be programmed to one of eight charge storage states (e.g., L0, L1, L2, L3, L4, L5, L6, and L7), respectively. In operation, a memory cell can be programmed such that it has a charge storage state corresponding to one of L0, L1, L2, L3, L4, L5, L6, or L7. For instance, charge storage state L0 can represent a stored information value such as binary “111.”

[0040] A number of sensing signal magnitudes (e.g., R1, R2, R3, R4, R5, R6, and R7) can be used to determine the charge storage state of a memory cell. According to some previous approaches to sensing a memory cell, a sensing signal can be applied to the memory cell. If the memory cell conducts in response to the applied sensing signal, then the charge storage state of the memory cell may be equal to or less than the magnitude of the sensing signal. With respect to Figure 3A, if application of the sensing signal magnitude R1

causes the memory cell to conduct, then the charge storage state of the memory cell is L0. Thus, it can be said that sensing signal magnitude R1 corresponds to charge storage state L0. Charge storage states greater than L0 can be determined by application of a sensing signal with a greater magnitude (e.g., R2).

[0041] A sensing magnitude corresponding to a respective charge storage state for the MLC does not necessarily indicate that the sensing magnitude is used to sense the corresponding state, but rather can indicate that the sensing magnitude is adjacent to the corresponding charge storage state. For example, with respect to Figure 3A, sensing magnitude R1 can correspond to charge storage state L0, sensing magnitude R2 can correspond to charge storage state L1, etc. Charge storage states L0, L1, L2, ..., L7 (in order) can be said to be consecutive charge storage states. Sensing magnitudes R1, R2, ..., R7 (in order) can be said to be consecutive sensing magnitudes.

[0042] Figure 3B illustrates a diagram of a sensing signal for a multilevel memory cell according to some previous approaches. According to some previous approaches, a sensing signal can be increased through a number of magnitudes (e.g., R1, R2, R3, R4, R5, R6, and R7) for a three-unit memory cell. The sensing operation can proceed by increasing the magnitude of the sensing signal through the number of magnitudes serially in sequence (e.g., from R1 to R2, ... to R7). By increasing the magnitude of the sensing signal from R1 through R7, the charge storage state (e.g., L0, L1, L2, L3, L4, L5, L6, or L7) of the memory cell can be determined. As illustrated, the time for such a sensing operation may be relatively long as compared to a similar sensing operation performed on a two-unit memory cell as illustrated in Figure 3C.

[0043] Figure 3C illustrates a diagram of a sensing signal for a multilevel memory cell according to some previous approaches. According to some previous approaches, a sensing signal can be increased through a number of magnitudes (e.g., R1, R2, R3) for a two-unit memory cell. The sensing operation can proceed by increasing the magnitude of the sensing signal through the number of magnitudes serially in sequence (e.g., from R1 to R2 and from R2 to R3). By increasing the magnitude of the sensing signal from R1 through R3, the charge storage state (e.g., L0, L1, L2, or L3) of the memory cell can be determined. As illustrated, the time for such a sensing operation may be

relatively short as compared to a similar sensing operation performed on a three-unit memory cell as illustrated in Figure 3B.

[0044] Figure 4A illustrates a diagram of a first sensing signal for a multilevel memory cell in accordance with a number of embodiments of the present disclosure. The sensing signal can change from a starting magnitude to a particular magnitude (e.g., a fourth sensing magnitude, R4) corresponding to a respective charge storage state for an MLC. For example, the sensing magnitude R4 can be used, for a 3-unit MLC, to determine whether the charge storage state of the MLC is one of L0, L1, L2, and L3 or one of L4, L5, L6 and L7. If the MLC conducts in response to the sensing signal with the magnitude R4, then the MLC is in one of L0, L1, L2, and L3. However, if the MLC does not conduct in response to the sensing signal with the magnitude R4, then the MLC is in one of L4, L5, L6, and L7. According to a scheme for correlating units of information with charge storage states of a multilevel memory cell in accordance with a number of embodiments of the present disclosure (e.g., the scheme illustrated in Figure 5), the sensing signal having the magnitude of R4 can be used to sense a first unit of information from the MLC. For example, a first unit of information of "1" can be correlated with charge storage states L0, L1, L2, and L3 while a first unit of information of "0" can be correlated with charge storage states L4, L5, L6, and L7. However, embodiments are not so limited, as the "1" and "0" could be correlated oppositely, and/or a second or third of the three units of information can be correlated with the charge storage states as described above. The first unit of information can correspond to (e.g., be a portion of) a page of information stored in a plurality of memory cells.

[0045] In some embodiments, the sensing signal illustrated in Figure 4A can be used to read a page of information from a plurality of memory cells. The sensing signal illustrated in Figure 4A can be part of one of a plurality of sensing operations used to read information from an MLC (e.g., a 3-unit MLC). For example, the sensing signals illustrated in Figures 4B-4C can be others of the plurality of sensing operations for reading information from the MLC. A number of embodiments of the present disclosure can include selecting one of the plurality of sensing operations to read information from the MLC in response to a request for a particular page of information. That is, each of the sensing operations illustrated in Figures 4A-4C can be used to read a respective page of

information from the MLC, and/or from a number of MLCs. The MLC can store a plurality of units of information corresponding to a plurality of pages of information (e.g., 3 units of information, each corresponding to one of three pages of information). Each of the plurality of sensing operations can correspond to a respective one of the plurality of pages of information (e.g., such that each sensing operation can read information from one of the plurality of pages of information without reading information from others of the plurality of pages of information). As is illustrated in Figures 4A-4C, the sensing signals illustrated in each figure do not include a common sensing magnitude (e.g., the sensing signal is not allowed to settle at a common magnitude, although, for example, the sensing signal illustrated in Figure 4A passes through magnitude R1 before settling at R4 and the sensing signal illustrated in Figure 4C settles at R1). Each of the plurality of sensing operations may not include a sensing magnitude (e.g., may not settle on a sensing magnitude) for all of the potential charge storage states of the MLC.

[0046] Figure 4B illustrates a diagram of a second sensing signal for the multilevel memory cell in accordance with a number of embodiments of the present disclosure. The sensing signal can change from a starting magnitude to a number of particular magnitudes (e.g., a second sensing magnitude, R2, a fifth sensing magnitude, R5, and a seventh sensing magnitude, R7) corresponding to respective charge storage states for an MLC. The sensing signal illustrated in Figure 4B can be part of one of a plurality of sensing operations used to read information from an MLC (e.g., a 3-unit MLC).

[0047] Figure 4C illustrates a diagram of a third sensing signal for the multilevel memory cell in accordance with a number of embodiments of the present disclosure. The sensing signal can change from a starting magnitude to a number of particular magnitudes (e.g., a first sensing magnitude, R1, a third sensing magnitude, R3, and a sixth sensing magnitude, R6) corresponding to respective charge storage states for an MLC. The sensing signal illustrated in Figure 4C can be part of one of a plurality of sensing operations used to read information from an MLC (e.g., a 3-unit MLC).

[0048] In some embodiments, an MLC can store three units of information. In such embodiments, a first one of a plurality of sensing operations can be selected to sense a first one of the three units of information

using a sensing signal of a first sensing magnitude (e.g., the sensing signal illustrated in Figure 4A at R4). Selecting one of the plurality of sensing operations can include selecting a second one of the plurality of sensing operations (e.g., the sensing operation illustrated in association with the sensing signal illustrated in Figure 4B, which changes from R2 to R5 to R7, for example) to sense a second one of the three units of information using a sensing signal that changes from a second sensing magnitude to a third sensing magnitude, and from the third sensing magnitude to a fourth sensing magnitude, where each sensing magnitude corresponds to a respective charge storage state for the MLC. Selecting one of the plurality of sensing operations can include selecting a third one of the plurality of sensing operations (e.g., the sensing operation illustrated in association with the sensing signal illustrated in Figure 4C, which changes from R1 to R3 to R6, for example) to sense a third one of the three units of information using a sensing signal that changes from a fifth sensing magnitude to a sixth sensing magnitude, and from the sixth sensing magnitude to a seventh sensing magnitude. The use of the terms “first,” “second,” “third,” etc., herein do not necessarily imply a consecutive order, but rather are used to distinguish one thing (such as a magnitude of a sensing signal or unit of information) from another. Thus, the language “a first one of the three units of information” and “a second one of the three units of information” does not imply that “the first one of the three units of information” must be the first of the three units of information in order. Rather the “first one of the three units of information” can be any one of the three units of information.

[0049] In a number of embodiments, a first page of information can be read from each of a number of MLCs with a first number of sensing magnitudes by increasing a magnitude of a sensing signal through each of the first number of sensing magnitudes. The first number of sensing magnitudes can include an order of sensing magnitudes that are nonconsecutive with respect to a plurality of consecutive charge storage states for the number MLCs. The magnitude of the sensing signal can be allowed to settle at each of the first number of sensing magnitudes. In some embodiments, the magnitude of the sensing signal can be allowed to settle at each of the first number of sensing magnitudes without allowing the magnitude of the sensing signal to settle at other sensing

magnitudes. A second page of information can be read from each of the number of MLCs with a second number of sensing magnitudes.

[0050] Figure 5 illustrates a diagram 516 of a scheme for correlating units of information with charge storage states of a multilevel memory cell in accordance with a number of embodiments of the present disclosure. The columns 518 can represent the possible combinations of units of information stored in a 3-unit memory cell for the eight different possible charge storage states of the 3-unit memory cell. That is, a 3-unit memory cell can be programmed to one of eight charge storage states (e.g., A-H). Column A is a charge storage state representing the units of information 111, column B is a charge storage state representing the units of information 110, column C is a charge storage state representing the units of information 100, column D is a charge storage state representing the units of information 101, column E is a charge storage state representing the units of information 001, column F is a charge storage state representing the units of information 011, column G is a charge storage state representing the units of information 010, and column H is a charge storage state representing the units of information 000.

[0051] The rows 520 can represent the information sensed from the MLC by a particular sensing operation. The first row "Sense1" can represent the information sensed using the sensing operation illustrated and described with respect to Figure 4A. For example, if "Sense1" is used to sense an MLC programmed to charge storage state A, then the unit of information "1" can be sensed from the MLC. The second row "Sense2" can represent the information sensed using the sensing operation illustrated and described with respect to Figure 4B. The third row "Sense3" can represent the information sensed using the sensing operation illustrated and described with respect to Figure 4C. In contrast to some previous approaches to sensing MLCs, any one of the three sensing operations can be used independently to sense the indicated information.

[0052] The charge storage states A, B, . . . , H can correspond, in order, to the charge storage states L0, L1, . . . , L7 illustrated in Figure 3A. The sensing signal magnitudes R1, R2, . . . , R7 illustrated in Figures 4A-4C can have magnitudes between the charge storage states A, B, . . . , H, respectively. For example, R1 can be between A and B, R2 can be between B and C, etc. The scheme for correlating units of information with charge storage states of an MLC

illustrated in Figure 5 can allow for independent sensing of information corresponding to different pages from an MLC without applying a discrete sensing signal magnitude and/or allowing a magnitude of a sensing signal to settle at each of the sensing signal magnitudes that are used to read information from the MLC, however embodiments are not limited to the specific scheme illustrated in Figure 5. Although Figure 5 is specific to a 3-unit memory cell, embodiments are not so limited, as one of ordinary skill in the art having read and understood the present disclosure could apply the scheme illustrated in Figure 5 to MLCs storing other numbers of units of information.

[0053] Figure 6A illustrates a diagram of a first sensing signal for a multilevel memory cell in accordance with a number of embodiments of the present disclosure. The sensing signal can change from a starting magnitude to a number of particular magnitudes (e.g., a second sensing magnitude, R2, a fourth sensing magnitude, R4, and a fifth sensing magnitude, R5) corresponding to respective charge storage states for an MLC. The sensing signal illustrated in Figure 6A can be part of one of a plurality of sensing operations used to read information from an MLC (e.g., a 2.5-unit MLC). For example, the sensing signals illustrated in Figure 6B can be another of the plurality of sensing operations for reading information from the MLC.

[0054] Figure 6B illustrates a diagram of a second sensing signal for the multilevel memory cell in accordance with a number of embodiments of the present disclosure. The sensing signal can change from a starting magnitude to a number of particular magnitudes (e.g., a first sensing magnitude, R1, a third sensing magnitude, R3, and a fourth sensing magnitude, R4) corresponding to respective charge storage states for an MLC. In various embodiments, the first and the second numbers of sensing magnitudes can include, at most, one common sensing magnitude (e.g., with respect to Figures 6A-6B for 2.5-unit MLCs, the fourth consecutive sensing magnitude, R4, can be common to the first number of sensing magnitudes and the second number of sensing magnitudes). The sensing signal illustrated in Figure 6B can be part of one of a plurality of sensing operations used to read information from an MLC (e.g., a 2.5-unit MLC).

[0055] A sensing signal can be changed from a first sensing magnitude to a second sensing magnitude and from the second sensing magnitude to a third

sensing magnitude. In some embodiments, up to three units of information can be sensed collectively from two 2.5-unit MLCs with the changing sensing signal. The second sensing magnitude can be nonconsecutive from the first sensing magnitude and/or the third sensing magnitude can be nonconsecutive from the second sensing magnitude with respect to a plurality of charge storage states of an MLC. Each sensing magnitude can correspond to a respective charge storage state for the MLC. The changing sensing signal can be used to sense more than one unit of information from the MLC. The more than one unit of information can correspond to one page of information (e.g., possibly including other units of information stored in other MLCs). Each MLC can store a plurality of units of information corresponding to more than one page of information. In a number of embodiments, up to three units of information can be sensed from the two 2.5-unit memory cells without sensing a remainder of units of information stored collectively by the two MLCs. For example, the three units of information sensed from the two 2.5-unit memory cells can correspond to one page of information and the two 2.5-unit memory cells can store five units of information collectively, where the five units of information correspond to two pages of information. The three units of information can be sensed in response to a request for the corresponding page of information (e.g., from a host).

[0056] Figure 7 illustrates a diagram 716 of a scheme for correlating units of information with charge storage states of a number of multilevel memory cells in accordance with a number of embodiments of the present disclosure. The diagram includes charge storage states for two MLCs (C0 and C1). The left side column 722 illustrates the six possible charge storage states for the first MLC (C0) (e.g., a, b, c, d, e, and f). The top row 724 illustrates the six possible charge storage states for the second MLC (C1) (e.g., A, B, C, D, E, and F). Each of the first and the second MLCs can store a non-integer number of units of information (e.g., 2.5 units of information represented by one of six charge storage states). The grid 726 between the charge storage states for MLCs C0 and C1 illustrates the combined 5-units of information represented collectively by the charge storage states of each MLC. For example, if MLC C0 is programmed to charge storage state “a” and MLC C1 is programmed to charge storage state A, then the two MLCs can collectively store the information “11111,” as indicated by the corresponding grid member 728.

[0057] Each grid member includes 5 units of information. A particular sensing operation (e.g., the sensing operation illustrated and described with respect to Figure 6A or Figure 6B) can sense up to 3 of the 5 units of information from the two memory cells. As illustrated in Figure 7, a first sensing operation “S1” can sense the first two units of information of each grid member while a second sensing operation “S2” can sense the second two units of information of each grid member. As is also illustrated, either sensing operation “S1” or sensing operation “S2” can sense the fifth unit of information of each grid member. Sensing operation “S1” can correspond to the sensing operation illustrated and described with respect to Figure 6A and the sensing operation “S2” can correspond to the sensing operation illustrated and described with respect to Figure 6B. In contrast to some previous approaches to sensing MLCs that store a non-integer number of units of information, either one of the two sensing operations can be used independently to sense the indicated information (e.g., without sensing a remainder of the information stored in the MLCs). In some embodiments, more than one unit of information can be sensed from each of two MLCs respectively with a changing sensing signal. In some embodiments, each of the two MLCs can store a non-integer number of units of information.

[0058] The charge storage states a, b, . . . , f and the charge storage states A, B, . . . , F can both correspond, in order, to the charge storage states L0, L1, . . . , L5 illustrated in Figure 3A. The sensing signal magnitudes R1, R2, . . . , R5 illustrated in Figures 6A-6B can have magnitudes between the charge storage states a, b, . . . , f and the charge storage states A, B, . . . , F, respectively. For example, R1 can be between “a” and “b” or between A and B, R2 can be between “b” and “c” or between B and C, etc. The scheme for correlating units of information with charge storage states of a pair of MLCs, each storing a non-integer number of units of information illustrated in Figure 7 can allow for independent sensing of information corresponding to different pages from the pair of MLCs without applying a discrete sensing signal magnitude and/or allowing a magnitude of a sensing signal to settle at each of the sensing signal magnitudes that are used to sense information from the pair of MLCs. Although Figure 7 is specific to a 2.5-unit MLCs, embodiments are not so limited, as one of ordinary skill in the art having read and understood the present disclosure could

apply the scheme illustrated in Figure 7 to MLCs storing other non-integer numbers of units of information.

Conclusion

[0059] The present disclosure includes apparatuses and methods for nonconsecutive sensing of multilevel memory cells. A number of methods include sensing a unit of information from a multilevel memory cell (MLC) using a sensing signal. The unit of information can correspond to a page of information. The MLC can store a plurality of units of information corresponding to a plurality of pages of information. The sensing signal can change from a first sensing magnitude to a second sensing magnitude and from the second sensing magnitude to a third sensing magnitude. The second sensing magnitude can be nonconsecutive from the first sensing magnitude and/or the third sensing magnitude can be nonconsecutive from the second sensing magnitude with respect to a plurality of sensing magnitudes corresponding to a plurality of charge storage states of the MLC.

[0060] Although specific embodiments have been illustrated and described herein, those of ordinary skill in the art will appreciate that an arrangement calculated to achieve the same results can be substituted for the specific embodiments shown. This disclosure is intended to cover adaptations or variations of one or more embodiments of the present disclosure. It is to be understood that the above description has been made in an illustrative fashion, and not a restrictive one. Combination of the above embodiments, and other embodiments not specifically described herein will be apparent to those of skill in the art upon reviewing the above description. The scope of the one or more embodiments of the present disclosure includes other applications in which the above structures and methods are used. Therefore, the scope of one or more embodiments of the present disclosure should be determined with reference to the appended claims, along with the full range of equivalents to which such claims are entitled.

[0061] In the foregoing Detailed Description, some features are grouped together in a single embodiment for the purpose of streamlining the disclosure. This method of disclosure is not to be interpreted as reflecting an intention that the disclosed embodiments of the present disclosure have to use more features

than are expressly recited in each claim. Rather, as the following claims reflect, inventive subject matter lies in less than all features of a single disclosed embodiment. Thus, the following claims are hereby incorporated into the Detailed Description, with each claim standing on its own as a separate embodiment.

What is claimed is:

1. A method, comprising:
sensing a unit of information from a multilevel memory cell (MLC) using a sensing signal, wherein the unit of information corresponds to a page of information, wherein the MLC stores a plurality of units of information corresponding to a plurality of pages of information, and wherein the sensing signal changes from a first sensing magnitude to a second sensing magnitude and from the second sensing magnitude to a third sensing magnitude, wherein the second sensing magnitude is nonconsecutive from the first sensing magnitude and/or the third sensing magnitude is nonconsecutive from the second sensing magnitude with respect to a plurality of sensing magnitudes corresponding to a plurality of charge storage states of the MLC.
2. The method of claim 1, wherein sensing the unit of information from the MLC comprises sensing up to three units of information from two MLCs.
3. The method of claim 2, wherein each of the two MLCs store a non-integer number of units of information.
4. The method of claim 1, wherein sensing the unit of information from the MLC comprises sensing a single unit from the MLC using the sensing signal.
5. The method of claim 1 wherein the method includes sensing another unit of information from the MLC with another sensing signal, wherein the other unit of information corresponds to another page of the plurality of pages of information.
6. A method, comprising:
sensing up to three units of information collectively from two multilevel memory cells (MLCs) with a single sensing signal, wherein each MLC stores 2.5 units of information and wherein the sensing signal changes from a first sensing magnitude to a second sensing magnitude to a third sensing magnitude.

7. The method of claim 6, wherein the second sensing magnitude is nonconsecutive from the first sensing magnitude and/or the third sensing magnitude is nonconsecutive from the second sensing magnitude with respect to a plurality of charge storage states of the MLCs.

8. The method of claim 7, wherein the method includes sensing the up to three units of information without sensing a remainder of units of information stored collectively by the two MLCs.

9. The method of claim 6, wherein the up to three units of information correspond to a page of information, and wherein the two MLCs store five units of information collectively corresponding to two pages of information.

10. The method of claim 9, wherein the method includes sensing the up to three units of information in response to a request for the corresponding page of information.

11. The method of claim 10, wherein the method includes sensing the up to three units of information without sensing a remainder of the five units of information.

12. A method, comprising:

selecting one of a plurality of sensing operations to sense information from a multilevel memory cell (MLC) in response to a request for a particular page of information;

wherein the MLC stores a plurality of units of information corresponding to a plurality of pages of information, wherein each of the plurality of sensing operations corresponds to a respective one of the plurality of pages of information, and wherein the plurality of sensing operations do not include a common sensing magnitude.

13. The method of claim 12 wherein the plurality of sensing operations do not include a sensing magnitude for each charge storage state of the MLC.
14. The method of claim 12, wherein the MLC stores three units of information, and wherein selecting one of the plurality of sensing operations comprises selecting a first one of the plurality of sensing operations to sense a first one of the three units of information using a sensing signal of a first sensing magnitude.
15. The method of claim 14, wherein selecting one of the plurality of sensing operations comprises selecting a second one of the plurality of sensing operations to sense a second one of the three units of information using a sensing signal that changes from a second sensing magnitude to a third sensing magnitude, and from the third sensing magnitude to a fourth sensing magnitude, and wherein each sensing magnitude corresponds to a respective charge storage state for the MLC.
16. The method of claim 14, wherein selecting one of the plurality of sensing operations comprises selecting a third one of the plurality of sensing operations to sense a third one of the three units of information using a sensing signal that changes from a fifth sensing magnitude to a sixth sensing magnitude, and from the sixth sensing magnitude to a seventh sensing magnitude.
17. An apparatus, comprising:
an array of multilevel memory cells (MLCs);
a sensing signal generator; and
a controller coupled to the array and to the sensing signal generator and configured to:
change a magnitude of an output of the sensing signal generator serially through each of a first subset of a plurality of sensing magnitudes to sense a first page of information from a number of MLCs in the array; and

change the magnitude of the output of the sensing signal generator serially through each of a second subset of the plurality of sensing magnitudes to sense a second page of information from the number of MLCs in the array;

wherein each of the plurality of sensing magnitudes corresponds to a respective charge storage state for the number of MLCs.

18. The apparatus of claim 17, wherein the controller is further configured to change the magnitude of the output of the sensing signal generator serially through each of a third subset of the plurality of sensing magnitudes to sense a third page of information from the number of MLCs in the array.

19. The apparatus of claim 18, wherein the third subset of the plurality of sensing magnitudes comprises a single sensing magnitude.

20. The apparatus of claim 17, wherein the first page of information includes host data and error correction information.

21. The apparatus of claim 17, wherein the controller is further configured to:
read the first page of information in response to a first command; and
read the second page of information in response to a second command.

22. The apparatus of claim 17, wherein the controller is configured to read the first page of information and the second page of information in response to a single command.

23. The apparatus of claim 17, wherein each of the MLCs is configured to store a non-integer number of units of information.

24. The apparatus of claim 17, wherein the first subset of the plurality of sensing magnitudes includes a particular order of sensing magnitudes that are

nonconsecutive with respect to a plurality of charge storage states for the number of MLCs.

25. The apparatus of claim 17, wherein the sensing signal generator comprises a component within the controller.

26. The apparatus of claim 17, wherein the sensing signal generator is external to the controller.

27. The apparatus of claim 17, wherein the sensing signal generator comprises a number of components located within the controller and a number of components located external to the controller.

28. An apparatus, comprising:

an array of multilevel memory cells (MLCs); and

a controller coupled to the array and configured to:

sense a first page of information from each of a number of the MLCs with a first number of sensing magnitudes by increasing a magnitude of a sensing signal through each of the first number of sensing magnitudes; and

sense a second page of information from each of the number of the MLCs with a second number of sensing magnitudes, wherein the first number of sensing magnitudes include an order of sensing magnitudes that are nonconsecutive with respect to a plurality of consecutive charge storage states for the number of MLCs, and wherein the first number of sensing magnitudes and the second number of sensing magnitudes include, at most, one common sensing magnitude.

29. The apparatus of claim 28, wherein the first number of sensing magnitudes comprise a single sensing magnitude corresponding to a fourth of the consecutive charge storage states.

30. The apparatus of claim 29, wherein the second number of sensing magnitudes include a sensing magnitude corresponding to a second of the consecutive charge storage states, a sensing magnitude corresponding to a fifth of the consecutive charge storage states, and a seventh of the consecutive charge storage states, wherein the consecutive charge storage states include 8 charge storage states.

31. The apparatus of claim 30, wherein the controller is configured to sense a third page of information from each of the number of the MLCs with a third number of sensing magnitudes including a sensing magnitude corresponding to a first of the consecutive charge storage states, a sensing magnitude corresponding to a third of the consecutive charge storage states, and a sixth of the consecutive charge storage states.

32. The apparatus of claim 28, wherein the first number of sensing magnitudes include a sensing magnitude corresponding to a second of the consecutive charge storage states, a sensing magnitude corresponding to a fourth of the consecutive charge storage states, and a fifth of the consecutive charge storage states, wherein the consecutive charge storage states include 6 charge storage states.

33. The apparatus of claim 32, wherein the second number of sensing magnitudes include a sensing magnitude corresponding to a first of the consecutive charge storage states, a sensing magnitude corresponding to a third of the consecutive charge storage states, and a sensing magnitude corresponding to a fourth of the consecutive charge storage states.

34. The apparatus of claim 28, wherein the array of MLCs are arranged in a NOR configuration, and wherein the controller is configured to store a non-integer number of units of information in each of the number of MLCs.

35. The apparatus of claim 28, wherein the controller is configured to provide random access to the MLCs in the array.

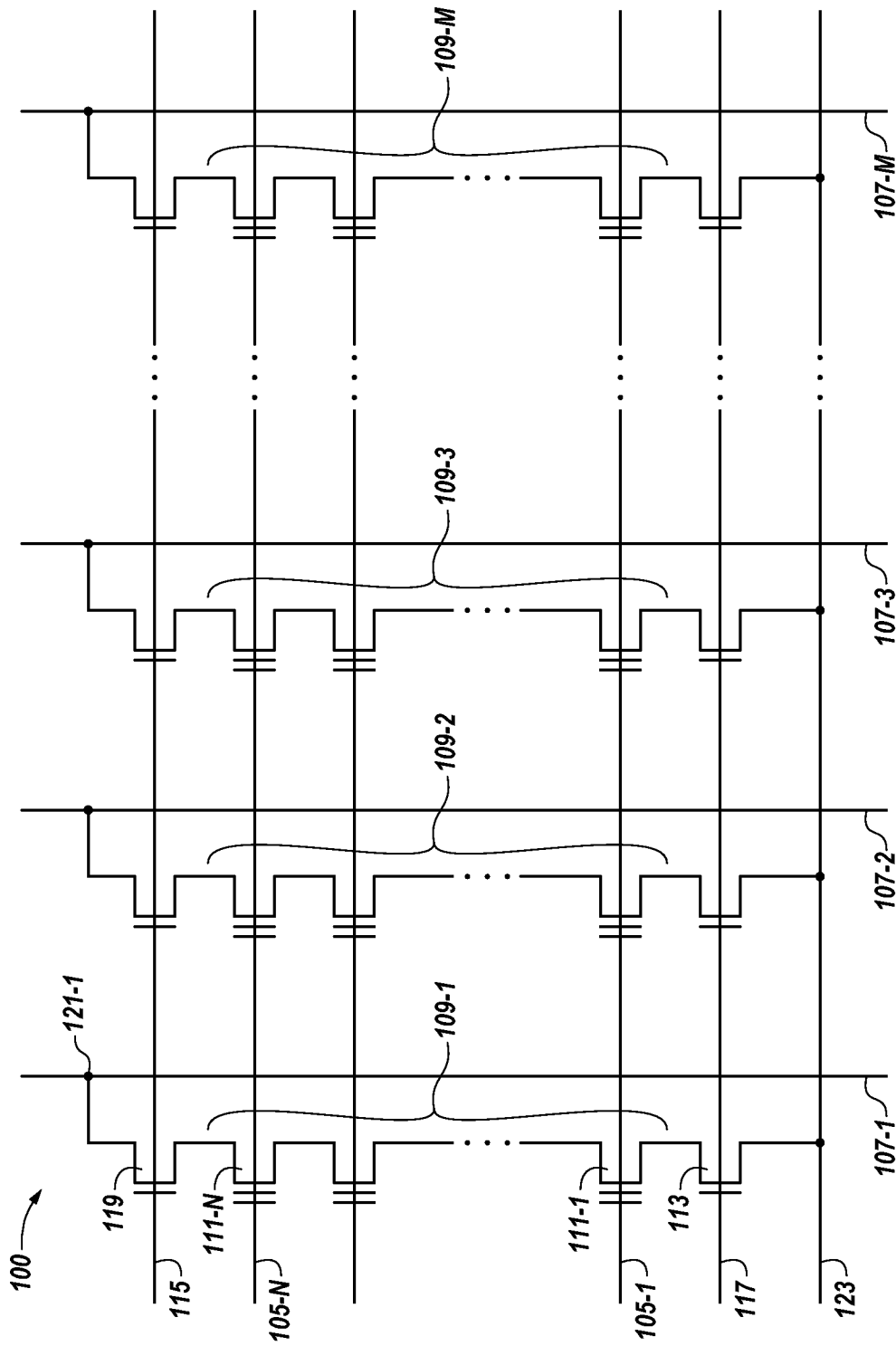

Fig. 1

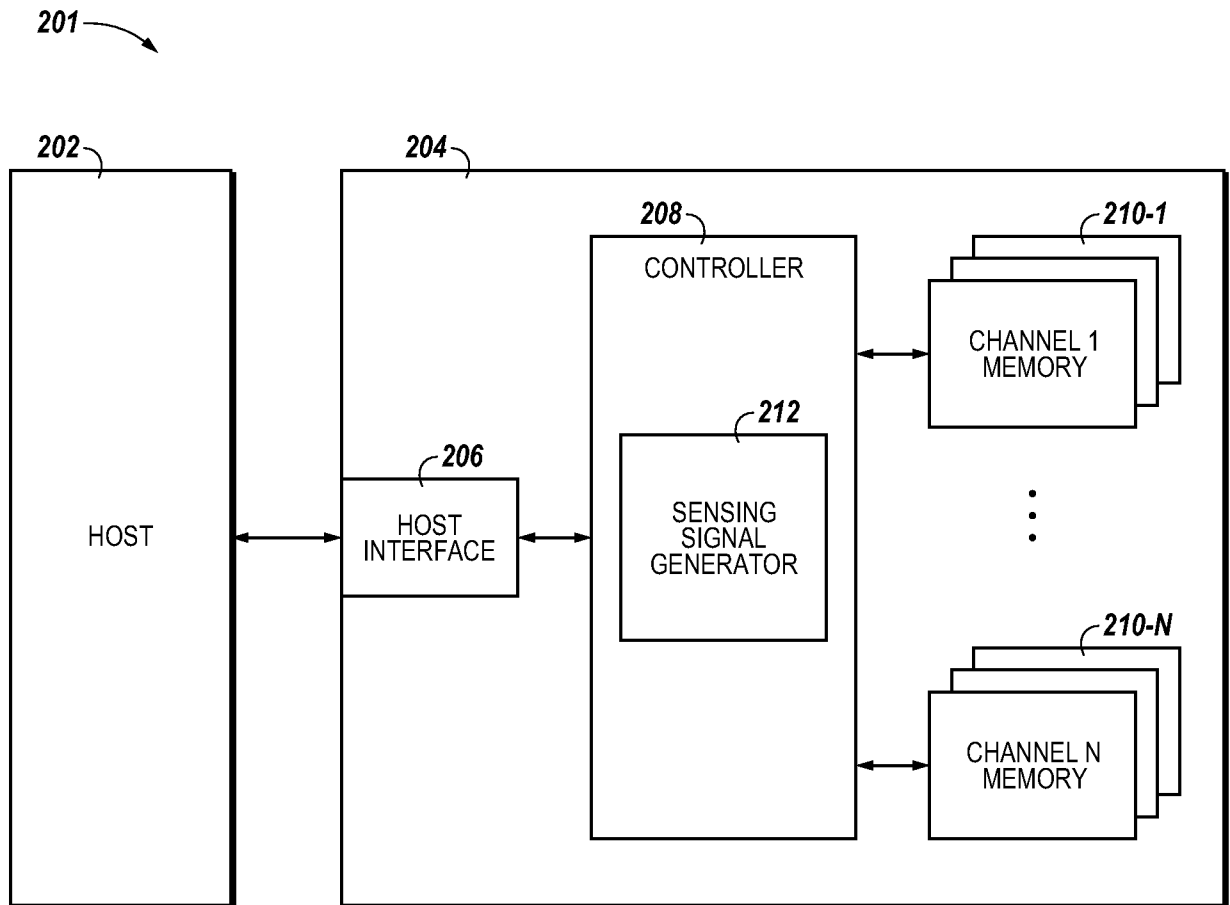

Fig. 2

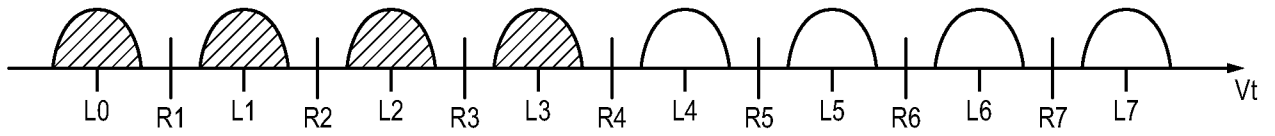

Fig. 3A

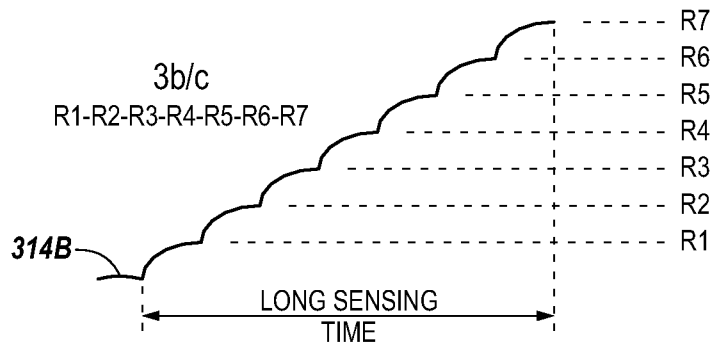

Fig. 3B
(PRIOR ART)

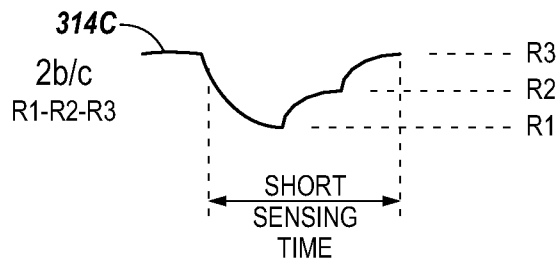

Fig. 3C
(PRIOR ART)

4/6

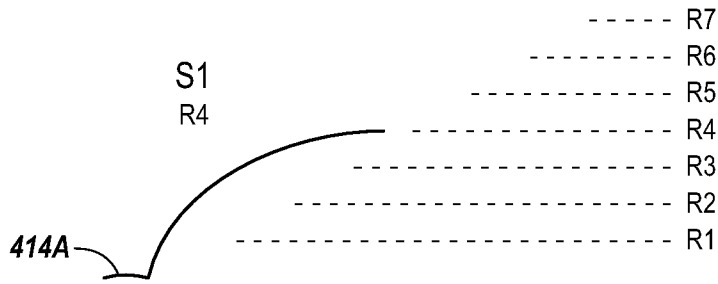

Fig. 4A

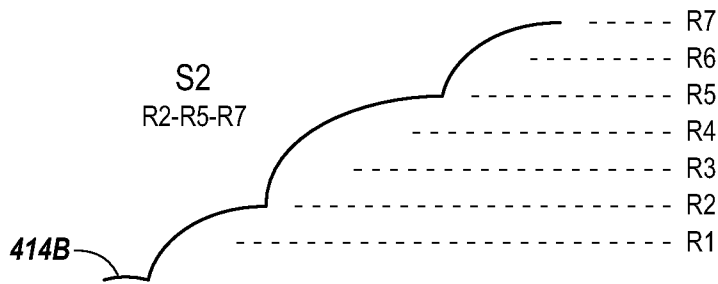

Fig. 4B

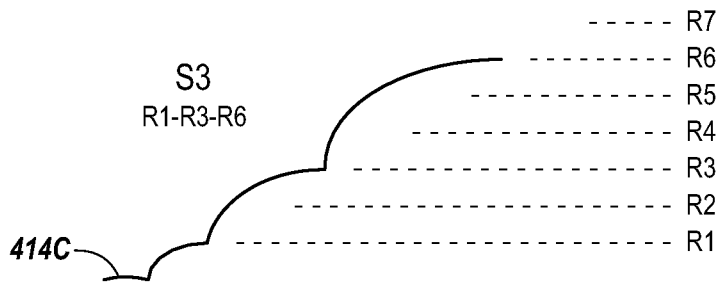

Fig. 4C

5/6

516 →

518

520

	A	B	C	D	E	F	G	H
SENSE1 --> BIT2	1	1	1	1	0	0	0	0
SENSE2 --> BIT1	1	1	0	0	0	1	1	0
SENSE3 --> BIT0	1	0	0	1	1	1	0	0

Fig. 5

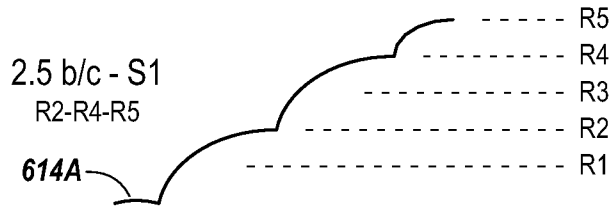

Fig. 6A

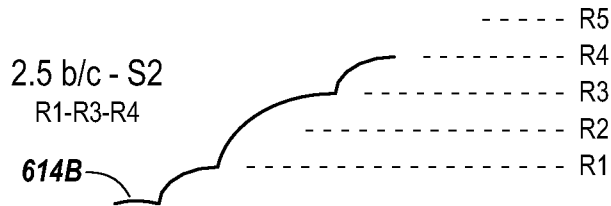

Fig. 6B

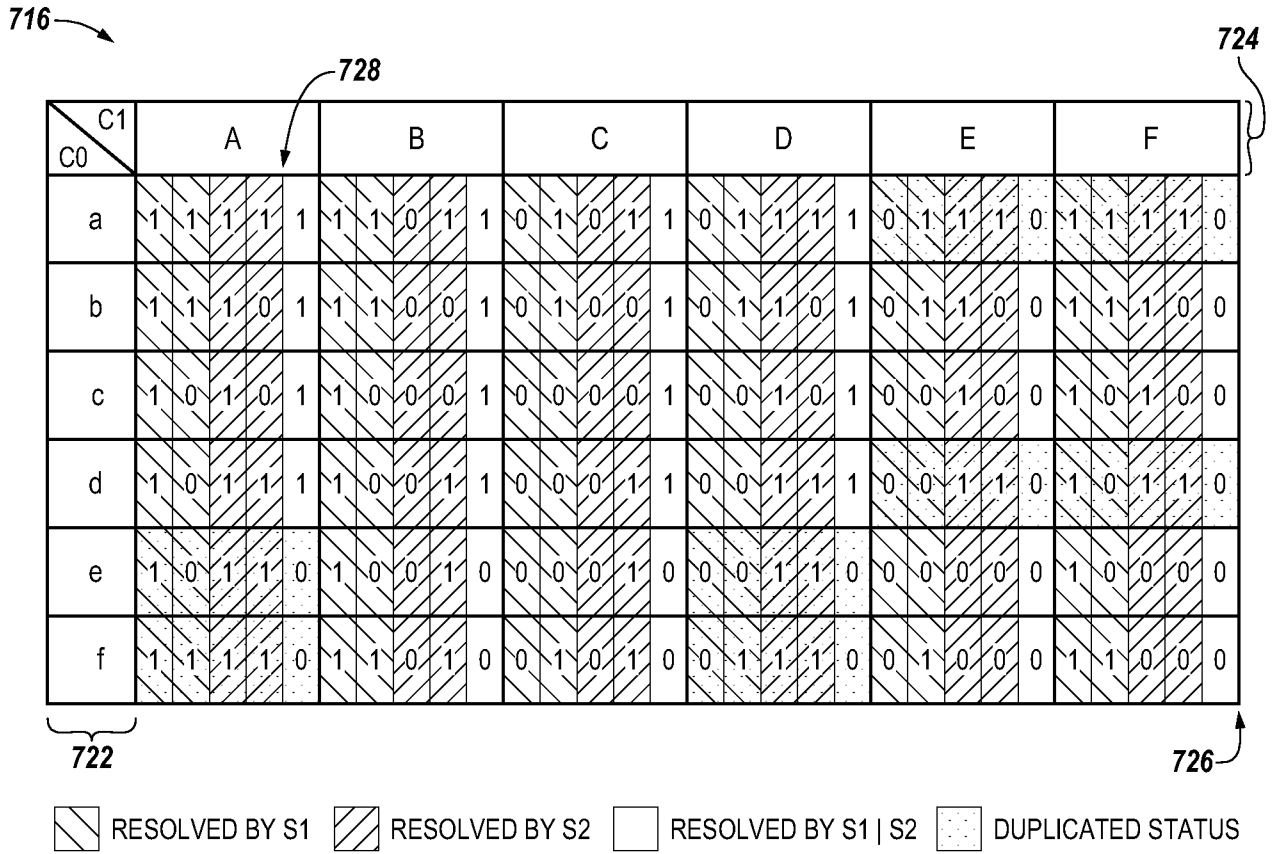

Fig. 7

INTERNATIONAL SEARCH REPORT

International application No.

PCT/CN2012/000314

A. CLASSIFICATION OF SUBJECT MATTER

G11C 11/00 (2006.01) i

According to International Patent Classification (IPC) or to both national classification and IPC

B. FIELDS SEARCHED

Minimum documentation searched (classification system followed by classification symbols)

IPC: G11C, H01L, G06F

Documentation searched other than minimum documentation to the extent that such documents are included in the fields searched

Electronic data base consulted during the international search (name of data base and, where practicable, search terms used)

CPRSABS,CNKI,VEN: sensing, signal, magnitude, MLC, multilevel w memory w cell, information, unit, page, nonconsecutive

C. DOCUMENTS CONSIDERED TO BE RELEVANT

Category*	Citation of document, with indication, where appropriate, of the relevant passages	Relevant to claim No.
X	CN 101958142 A (BEIJING GIGADEVICE SEMICONDUCTOR INC) 26 Jan. 2011 (26.01.2011) paragraphs [0008]-[0038], figures 1-4	6, 12
A		1-5, 7-11, 13-35
A	US 2010027351 A1 (SAMSUNG ELECTRONICS CO LTD) 04 Feb. 2010 (04.02.2010) the whole document	1-35
A	US 2011179244 A1 (SONY CORP) 21 Jul. 2011 (21.07.2011) the whole document	1-35

 Further documents are listed in the continuation of Box C. See patent family annex.

* Special categories of cited documents:	“T” later document published after the international filing date or priority date and not in conflict with the application but cited to understand the principle or theory underlying the invention
“A” document defining the general state of the art which is not considered to be of particular relevance	“X” document of particular relevance; the claimed invention cannot be considered novel or cannot be considered to involve an inventive step when the document is taken alone
“E” earlier application or patent but published on or after the international filing date	“Y” document of particular relevance; the claimed invention cannot be considered to involve an inventive step when the document is combined with one or more other such documents, such combination being obvious to a person skilled in the art
“L” document which may throw doubts on priority claim (S) or which is cited to establish the publication date of another citation or other special reason (as specified)	“&” document member of the same patent family
“O” document referring to an oral disclosure, use, exhibition or other means	
“P” document published prior to the international filing date but later than the priority date claimed	

Date of the actual completion of the international search 28 Nov. 2012 (28.11.2012)	Date of mailing of the international search report 27 Dec. 2012 (27.12.2012)
--	--

Name and mailing address of the ISA/CN
The State Intellectual Property Office, the P.R.China
6 Xitucheng Rd., Jimen Bridge, Haidian District, Beijing, China
100088
Facsimile No. 86-10-62019451

Authorized officer

TIAN, Zhigang

Telephone No. (86-10)62411705

INTERNATIONAL SEARCH REPORT

International application No.
PCT/CN2012/000314

C (Continuation). DOCUMENTS CONSIDERED TO BE RELEVANT

Category*	Citation of document, with indication, where appropriate, of the relevant passages	Relevant to claim No.
A	US 2008256287 A1 (SUPER TALENT ELECTRONICS INC) 16 Oct. 2008 (16.10.2008) the whole document	1-35
A	US 2009285023 A1 (SAMSUNG ELECTRONICS CO LTD) 19 Nov. 2009 (19.11.2009) the whole document	1-35
A	US 2008279012 A1 (SAMSUNG ELECTRONICS CO LTD) 13 Nov. 2008 (13.11.2008) the whole document	1-35

INTERNATIONAL SEARCH REPORT
Information on patent family members

International application No.
PCT/CN2012/000314

Patent Documents referred in the Report	Publication Date	Patent Family	Publication Date
CN 101958142 A	26.01.2011	NONE	
US 2010027351 A1	04.02.2010	CN 101640071 A	03.02.2010
		KR 20100013847 A	10.02.2010
		JP 2010040162 A	18.02.2010
US 2011179244 A1	21.07.2011	JP 2011150461 A	04.08.2011
		CN 102129409 A	20.07.2011
US 2008256287 A1	16.10.2008	US 7886108 B2	08.02.2011
US 2009285023 A1	19.11.2009	KR 20090118396 A	18.11.2009
		WO 2009139567 A3	24.06.2010
		US 7864574 B2	04.01.2011
		WO 2009139567 A2	19.11.2009
		JP 2011521393 A	21.07.2011
US 2008279012 A1	13.11.2008	GB 2449175 A	12.11.2008
		KR 20080099693 A	13.11.2008
		US 7633803 B2	15.12.2009
		FR 2916085 A1	14.11.2008
		CN 101303892 A	12.11.2008
		KR 100890016 B1	25.03.2009
		DE 102008023819 A1	13.11.2008