

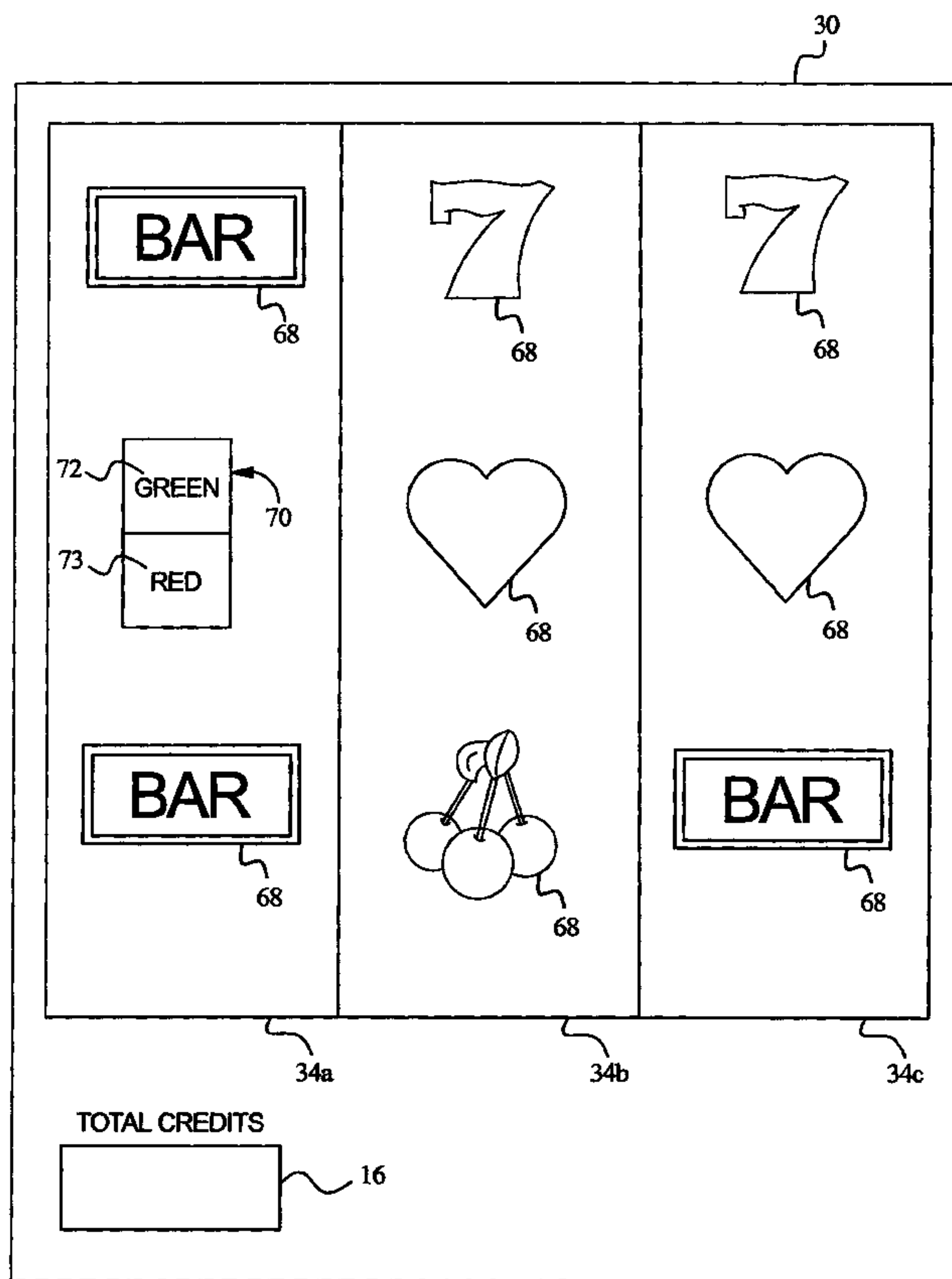

(22) Date de dépôt/Filing Date: 2002/09/12
 (41) Mise à la disp. pub./Open to Public Insp.: 2003/03/20
 (45) Date de délivrance/Issue Date: 2007/04/10
 (30) Priorité/Priority: 2001/09/20 (US09/957,305)

(51) Cl.Int./Int.Cl. *G07F 17/34* (2006.01)
 (72) Inventeur/Inventor:
 KAMINKOW, JOSEPH E., US
 (73) Propriétaire/Owner:
 IGT, US
 (74) Agent: FETHERSTONHAUGH & CO.

(54) Titre : APPAREIL DE JEU A SYMBOLES VOLANTS OU CARTES VOLANTES TRANSFORMABLES ET INDICATEURS D'ETAT
 (54) Title: GAMING DEVICE HAVING TRANSFORMABLE WILD SYMBOLS OR CARDS WITH WILD SIGNAL INDICATORS



(57) **Abrégé/Abstract:**

The present invention provides a gaming device having a transformable wild symbol or card on a set of reels or a transformable wild card in a set of cards. The transformable wild symbol or card provides a signal to a player through a wild indicator or a non-wild

(57) Abrégé(suite)/Abstract(continued):

indicator. The wild indicator indicates that the transformable wild symbol or card is in a wild state. The non-wild indicator indicates that the transformable wild symbol or card is in a non-wild state. In a wild state, the transformable wild symbol or card acts as a wild symbol or card on a set of reels, or a wild card.

ABSTRACT OF THE DISCLOSURE

The present invention provides a gaming device having a transformable wild symbol or card on a set of reels or a transformable wild card in a set of cards. The transformable wild symbol or card provides a signal to a player through a wild indicator or a non-wild indicator. The wild indicator indicates that the transformable wild symbol or card is in a wild state. The non-wild indicator indicates that the transformable wild symbol or card is in a non-wild state. In a wild state, the transformable wild symbol or card acts as a wild symbol or card on a set of reels, or a wild card.

SPECIFICATION**“GAMING DEVICE HAVING TRANSFORMABLE WILD SYMBOLS OR
CARDS WITH WILD SIGNAL INDICATORS”**

5

BACKGROUND OF THE INVENTION

Gaming devices are well known. Many known gaming devices provide wild symbols or wild cards. Wild symbols provide a player with an additional opportunity to obtain winning combinations. The use of wild symbols, wild cards or wild indicators in gaming devices provide additional excitement and entertainment for players.

In a slot machine having reels, a wild symbol can enable the matching of symbols along a payline to achieve a combination. For example, in a three reel slot machine, the symbols along a payline on the first, second and third reels may be, respectively, a heart, a heart and a wild symbol. If the gaming device awards a player for a three heart combination, the wild symbol substitutes for a heart and provides the player with that combination.

In a video poker game, a wild symbol substitutes for a card. For example, in a five card draw poker gaming machine where the gaming device displays five cards, the cards can be a 10, Jack, Queen, King and wild card. The wild card substitutes as an Ace and provides the player with a winning combination.

Wild cards have been employed in gaming devices in other manners. For example, U.S. Patent No. 5,431,408 discloses a gaming device having a video poker gaming scheme. A player is dealt a hand consisting of five cards. The player is also given a wild card. The wild card is separate from the dealt hand. The player can reserve the wild card for use with a subsequent hand. Thus, the player can use the wild card in a hand in which it is most advantageous to do so.

In another example, U.S. Patent No. 6,089,977 discloses a gaming device having a roaming wild symbol. More specifically, the patent discloses a gaming device having a plurality of virtual reels which have a set of symbols.

Certain symbol combinations serve as triggering events. When one of these combinations occur on the reels, a wild card symbol appears on the reels in the form of a graphical image and moves along the reels. As the wild card symbol moves from one symbol or location to adjacent symbols or locations, the symbols sequentially transform into the wild card symbol. After each move of the wild card symbol, the gaming device determines and pays the player for any winning combinations which are the result of the transformation. When the wild card symbol moves to the next adjacent symbol, the symbol previously transformed reverts to its original state.

To increase player enjoyment and excitement, it is desirable to provide gaming devices having new and different wild symbol, wild indicator and wild card schemes.

SUMMARY OF THE INVENTION

The present invention provides a gaming device having transformable wild symbols which selectively transform into wild symbols. A wild/non-wild signal is associated with the transformable wild symbol to indicate whether the transformable wild symbol is wild or not wild.

In one embodiment, the gaming device has a plurality of virtual reels. The reels include various symbols, such as hearts, numbers, cherries and other suitable symbols. The reels also include at least one transformable wild symbol which alternates between at least two states. The states are a wild state and a non-wild state. The wild/non-wild signal associated with the transformable wild symbol includes a wild indicator and a non-wild indicator. The wild indicator indicates when the transformable wild symbol is in a wild state. The non-wild indicator indicates when the transformable wild symbol is in a non-wild state.

In one embodiment, the transformable wild symbol is in the form of a traffic signal having a section displaying the word "RED" and a section displaying the word "GREEN." Lights corresponding to the words are also included in the sections. The "GREEN" section on the traffic signal is the wild indicator that indicates or informs the player that the transformable wild symbol

is in a wild state. The "RED" section on the traffic signal is the non-wild indicator that indicates or informs the player that the transformable wild symbol is in a non-wild state. When the "GREEN" section is lit or otherwise highlighted or indicated, the transformable wild symbol is in the wild state. In
5 the wild state, the transformable wild symbol may combine with symbols on the other reels to provide winning combinations in a conventional manner. When the "RED" section is lit or otherwise highlighted or indicated, the transformable wild symbol is in the non-wild state.

It should be appreciated that the transformable wild symbol of the
10 present invention is not limited to being a traffic signal, and can be any other symbol, indicia or indicator having a plurality of states. For example, the transformable wild symbol could be a die having six states, one for each face of the die, wherein some states are wild and some states are not wild. In another example, the transformable wild symbol is in the form of a coin which
15 has two states represented by "HEADS" and "TAILS." The "HEADS" side is a wild indicator and the "TAILS" side is a non-wild indicator.

If the transformable wild symbol is in a wild state, the gaming device may further inform the player that the transformable wild symbol is in a wild state. In one embodiment, the gaming device displays the word "WILD." The
20 gaming device can also emit an audio message from the speakers. Other audio or visual methods are also contemplated in accordance with the present invention.

In one embodiment of the present invention, the reels spin and stop in a conventional manner. If a transformable wild symbol appears on the reels,
25 and in one embodiment, on a payline of the reels, the wild indicator and the non-wild indicator begin to alternate and eventually stop alternating to provide either a wild state or a non-wild state which is determined by the processor of the gaming device.

The processor preferably randomly determines if the symbol is in the
30 wild or non-wild state. In one embodiment, each transformable wild symbol may have a probability that the transformable wild symbol will become wild which the processor uses to determine if the symbol will be wild or non-wild.

Each transformable wild symbol in a game may also have a different associated probability. In the traffic signal example, the "RED" and "GREEN" sections or lights would alternatively flash. In one embodiment, the processor causes the "RED" and "GREEN" sections to randomly flash. In a further embodiment, the wild-indicator and the non-wild indicator are alternating when the reels stop, so that the player immediately sees the alternating wild and non-wild states. In a further embodiment, the reels do not stop at the same time. They stop sequentially or in any order or combination. If the first reel includes a transformable wild symbol and stops such that the transformable wild symbol is on a payline, the other reels continue spinning while the wild indicator and the non-wild indicator alternate. Simultaneously when the next reel stops, the game maintains and displays the wild indicator or the non-wild indicator which is displayed at the moment the second reel stops. This creates an exciting and interesting game for the player, in part because the transformable wild symbol is not necessarily wild and the player must await the determination.

It should also be appreciated that the transformable wild symbol could be employed in other games. For example, in one embodiment, the gaming device displays a set of cards for a video poker game. A transformable wild symbol or card may be displayed on one or more of the cards. The gaming device displays a wild/non-wild signal to the player to indicate if the transformable wild symbol or card is in a wild state, the card which includes the transformable wild symbol or card becomes a wild card.

It is therefore an advantage of the present invention to provide a gaming device having a transformable wild symbol.

The present invention provides a gaming device comprising: a processor; a plurality of reels controlled by the processor; a plurality of symbols on the reels; and a transformable wild symbol on one of the reels, said transformable wild symbol having a plurality of states including a wild state and a non-wild state, wherein in the wild state the transformable wild symbol functions as one of the other symbols, and said transformable wild symbol having a wild indicator that indicates to a player that the transformable wild symbol is in a wild state and a

non-wild indicator that indicates to the player that the transformable wild symbol is in a non-wild state.

The present invention also provides a gaming device comprising: a display device; a processor which communicates with the display device; a set of video reels displayed by said display device; a plurality of symbols on said reels; a transformable wild symbol on at least one of said reels, said transformable wild symbol having a wild state and a non-wild state, wherein in the wild state the transformable wild symbol functions as one of the other symbols; a wild signal indicator which indicates to a player if the transformable wild symbol is in the wild state or the non-wild state; and a probability of being in the wild state associated with the transformable wild symbol, wherein said processor determines if the transformable wild symbol is in the wild state or non-wild state based on the probability associated with the transformable wild symbol when the transformable wild symbol is obtained by the player.

The present invention also provides a gaming device comprising: a display device; a processor which communicates with the display device; and a plurality of cards adapted to be selected by the processor and displayed by the display device, wherein at least one of the cards is adapted to be a transformable wild card, said transformable wild card having a wild state and a non-wild state and further having a wild indicator which indicates to a player that the transformable wild card is in the wild state or the non-wild state.

The present invention also provides a gaming device comprising: a display device; a processor in communication with said display device; a plurality of cards adapted to be selected by the processor and displayed by said display device; at least one of said cards being a transformable wild card having a wild state and a non-wild state, said transformable wild card further having a wild indicator which indicates if the transformable wild card is in a wild state or a non-wild state; and a probability of being in the wild state associated with the transformable wild card, wherein the processor determines if the transformable wild card is in the wild state or non-wild state based on the probability associated with the transformable wild card.

The present invention also provides a gaming device comprising: a processor; a plurality of reels controlled by the processor; and a plurality of symbols on the reels, wherein the processor randomly determines if at least one of the symbols is a transformable wild symbol which has a wild state and a non-wild state, and randomly determines if the randomly selected transformable wild symbol is in the wild state or non-wild state, wherein the randomly selected transformable wild symbol includes a wild indicator operable to indicate if the transformable wild symbol is in the wild state or the non-wild state.

The present invention also provides a gaming device comprising: a processor; a plurality of reels controlled by the processor; a plurality of symbols on the reels, wherein at least one symbol is adapted to be a transformable wild symbol having a wild state and a non-wild state; and at least two player selectable selections associated with at least one transformable wild symbol, wherein the non-wild state is associated with one selection and the wild state is associated with another one of the selections, and wherein the player's selection of one of the selections determines if the transformable wild symbol is in the wild state or the non-wild state.

The present invention also provides a gaming device comprising: a processor; a plurality of reels controlled by the processor; a plurality of symbols on the reels; a transformable wild symbol on one of the reels, said transformable wild symbol alternating between a plurality of states including a wild state and a non-wild state; at least one activator symbol on the reels, wherein upon the occurrence of the activator on said reels, the wild state or non-wild state of the transformable wild symbol is determined; and a wild indicator that indicates to a player that the transformable wild symbol is in a wild state, and a non-wild indicator that indicates to the player that the transformable wild symbol is in a non-wild state.

The present invention also provides a gaming device comprising: a processor; a plurality of reels controlled by the processor; a plurality of symbols on the reels; and a plurality of transformable wild symbols on one of the reels, said transformable wild symbols having a plurality of states including a wild state and a non-wild state, and said transformable wild symbols further having wild indicators that indicate to a player that the transformable wild symbols are in a

wild state and non-wild indicators that indicate to the player that the transformable wild symbols are in a non-wild state.

The present invention also provides a gaming device comprising: a processor; a plurality of reels controlled by the processor; a plurality of symbols on the reels; and a transformable wild symbol on one of the reels, said transformable wild symbol having a plurality of states including a wild state and a non-wild state and a limited wild state, and said transformable wild symbol having a wild indicator that indicates to a player that the transformable wild symbol is in a wild state, a non-wild state or a limited wild state.

The present invention also provides a gaming device comprising: a processor; a plurality of reels controlled by the processor; a plurality of symbols on the reels; a transformable wild symbol on one of the reels, said transformable wild symbol having a plurality of states including a wild state and a non-wild state, and said transformable wild symbol having a wild indicator that indicates to a player that the transformable wild symbol is in a wild state and a non-wild indicator that indicates to the player that the transformable wild symbol is in a non-wild state; and a storage medium accessible by the processor, wherein the storage medium includes instructions for causing the processor to: (a) spin the reels, (b) stop one of the reels, (c) display the transformable wild symbol on said stopped reel, (d) display said transformable wild symbol alternating between said wild and non-wild states using the wild indicator and the non-wild indicator, and (e) indicate that the transformable wild symbol is in one of the states using the wild indicator or the non-wild indicator.

The present invention also provides a gaming device comprising: a processor; a plurality of reels controlled by the processor; a plurality of symbols on the reels; a transformable wild symbol on one of the reels, said transformable wild symbol having a plurality of states including a wild state and a non-wild state, and said transformable wild symbol having a wild indicator that indicates to a player that the transformable wild symbol is in a wild state and a non-wild indicator that indicates to the player that the transformable wild symbol is in a non-wild state; and a storage medium accessible by the processor, said storage

medium including instructions for causing the processor to continue to spin the other reels after the reel with the transformable wild symbol stops.

The present invention also provides a gaming device comprising: a display device; a processor which controls the display device; a set of video reels displayed by said display device; a plurality of symbols on said reels; a plurality of transformable wild symbols on the reels, said transformable wild symbols having a wild state and a non-wild state; a wild signal indicator which indicates to a player if a transformable wild symbol is in the wild state or the non-wild state; and a probability of being in the wild state associated with each transformable wild symbol, wherein said processor determines if the transformable wild symbol is in the wild state or non-wild state based on the probability associated with each transformable wild symbol when the transformable wild symbol is obtained by the player.

The present invention also provides a gaming device comprising: a display device; a processor which communicates with the display device; and a plurality of cards adapted to be selected by the processor and displayed by the display device, wherein at least one of the cards is adapted to be a transformable wild card, said transformable wild card having a wild state and a non-wild state and a limited wild state and further having a wild indicator which indicates to a player that the transformable wild card is in the wild state, the non-wild state or the limited wild state.

The present invention also provides a gaming device comprising: a display device; a processor in communication with said display device; a plurality of cards adapted to be selected by the processor and displayed by said display device; a plurality of transformable wild cards having a wild state and a non-wild state, said transformable wild cards further having a wild indicator which indicates if the transformable wild card is in a wild state or a non-wild state; and a probability of being in the wild state associated with the transformable wild card, wherein the processor determines if the transformable wild card is in the wild state or non-wild state based on the probability associated with the transformable wild card.

The present invention also provides a gaming device operated under control of a processor, said gaming device comprising: a plurality of reels controlled by said processor; a plurality of symbols on the reels; at least one transformable wild symbol on at least one of said reels, said transformable wild symbol having a plurality of states including at least one wild state and at least one non-wild state; and said transformable wild symbol having a plurality of indicators including at least one wild indicator adapted to indicate the wild state and at least one non-wild indicator adapted to indicate the non-wild state, wherein said processor is operable to cause the wild indicator to indicate the wild state and to cause the non-wild indicator to indicate the non-wild state, wherein said processor is operable to determine whether the transformable wild symbol is in the wild state or the non-wild state, and if the transformable wild symbol is in the wild state the transformable wild symbol functions as at least one of the other symbols.

The present invention also provides a gaming device operated under control of a processor, said gaming device comprising: a plurality of reels controlled by said processor; a plurality of symbols on the reels; at least one transformable wild symbol on at least one of said reels, said transformable wild symbol having a plurality of states including at least one wild state, at least one non-wild state, and at least one repeat state; and at least one indicator including a wild signal adapted to indicate the wild state, a non-wild signal adapted to indicate the non-wild state, and a repeat signal adapted to indicate the repeat state, wherein the processor is operable to determine whether the transformable wild symbol is in the wild state, the non-wild state, or the repeat state, and if the transformable wild symbol is in the wild state the transformable wild symbol functions as at least one of the other symbols.

In a still further aspect, the present invention provides a method for providing a wagering game having a wild symbol, said method comprising the steps of: (a) displaying a set of reels; (b) displaying a plurality of symbols on said reels; (c) randomly displaying a transformable wild symbol on one of the reels, said transformable wild symbol having a wild state and a non-wild state, said

transformable wild symbol further having a wild signal indicator which indicates if the transformable wild symbol is in the wild state or the non-wild state; and (d) indicating to the player if said transformable wild symbol is in the wild state or the non-wild state.

5 The present invention also provides a method for providing a wagering game having a wild symbol, said method comprising: (a) displaying a set of reels; (b) displaying a plurality of symbols on said reels; (c) randomly displaying a transformable wild symbol alternating between a wild state and a non-wild state; and (d) indicating to the player if said transformable wild symbol is in the
10 wild state or the non-wild state.

 The present invention also provides a method for operating a wagering game, said method comprising: displaying a set of reels having a plurality of symbols, said symbols including a transformable wild symbol having a plurality of states including at least one wild state and at least one non-wild state, said
15 transformable wild symbol having a plurality of indicators including at least one wild indicator and at least one non-wild indicator; (a) activating the reels to cause a subset of said symbols to be displayed on the reels; (b) determining whether said subset includes the transformable wild symbol, and if the subset includes the transformable wild symbol: (i) determining if the transformable wild symbol is
20 in the wild state or the non-wild state, (ii) causing the wild indicator to indicate the wild state if the wild transformable symbol is in the wild state, (iii) causing the non-wild indicator to indicate the non-wild state if the wild transformable symbol is in the non-wild state, and (iv) causing the transformable wild symbol to function as at least one of the other symbols if the transformable wild symbol is
25 in the wild state; and (e) determining whether any winning combination of symbols is displayed on the reels, and providing an award if any winning combination of symbols is displayed.

 The present invention also provides a method for operating a wagering game, said method comprising: (a) displaying a set of reels having a plurality of
30 symbols, said symbols including a transformable wild symbol having a plurality of states including at least one wild state, at least one non-wild state, and at least

one repeat state; (b) activating the reels to cause a subset of said symbols to be displayed on the reels; (c) determining whether said subset includes the transformable wild symbol, and if the subset includes the transformable wild symbol: (i) determining if the transformable wild symbol is in the wild state, the non-wild state, or the repeat state, (ii) indicating whether the transformable wild symbol is in the wild state, the non-wild state, or the repeat state, and (iii) causing the transformable wild symbol to function as at least one of the other symbols if said transformable symbol is in the wild state; and (d) determining whether any winning combination of symbols is displayed, and providing an award if any winning combination of symbols is displayed.

The present invention also provides a method for operating a wagering game, said method comprising: (a) displaying a set of reels having a plurality of symbols, wherein said symbols include at least one activator symbol and at least one transformable wild symbol having a wild state and a non-wild state; (b) causing a subset of said symbols to be displayed on the reels; (c) if the subset includes the activator symbol and the transformable wild symbol: (i) determining whether the transformable wild symbol is in the wild state or the non-wild state, (ii) alternating an indication of the transformable wild symbol being in the wild state and the non-wild state, (iii) indicating whether the transformable wild symbol is in the wild state or the non-wild state, and (iv) causing the transformable wild symbol to function as at least one of the other symbols if said transformable symbol is in the wild state; and (d) determining whether any winning combination of symbols is displayed, and providing an award if any winning combination of symbols is displayed.

The present invention also provides a method for operating a wagering game, said method comprising: (a) displaying a set of reels having a plurality of symbols including a transformable wild symbol having a wild state, a non-wild state, and a limited wild state, said transformable wild symbol further having a wild indicator that indicates if the transformable wild symbol is in the wild state, the non-wild state, or the limited wild state; (b) activating the reels to cause a subset of said symbols to be displayed on the reels; (c) if the transformable wild

symbol is displayed on the reels: (i) determining whether the transformable wild symbol is in the wild state, the non-wild state or the limited wild state, (ii) causing the indicator to indicate whether the transformable wild symbol is in the wild state, the non-wild state, or the limited wild state, (iii) causing the transformable wild symbol to function as at least any of the other symbols if said transformable symbol is in the wild state, and (iv) causing the transformable wild symbol to function as one of a limited number of the other symbols if said transformable symbol is in the limited wild state; and (d) determining whether any winning combination of symbols is displayed, and providing an award if any winning combination of symbols is displayed.

The present invention also provides a method for operating a wagering game, said method comprising: (a) providing a plurality of cards, wherein at least one of said cards is adapted to function as a transformable wild card, said transformable wild card having a wild state and a non-wild state, and said transformable wild card further having a wild indicator that indicates whether the transformable wild card is in the wild state or the non-wild state; (b) displaying a subset of said cards; (c) determining whether said subset includes the transformable wild card; (d) if the subset includes the transformable wild symbols: (i) determining whether the transformable wild card is in the wild state or the non-wild state, (ii) causing the wild indicator to indicate if the transformable wild card is in the wild state, (iii) causing the wild indicator to indicate if the transformable wild card is in the non-wild state, and (iv) causing the transformable wild card to function as at least one of the other cards if said transformable card is in the wild state; and (e) determining whether any winning combination of cards is displayed, and providing an award if any winning combination of cards is displayed.

Other features and advantages of the invention will be apparent from the following detailed disclosure, taken in conjunction with the accompanying sheets of drawings, wherein like numerals refer to like parts, elements, components, steps and processes.

BRIEF DESCRIPTION OF THE FIGURES

Figs. 1A and 1B are perspective views of alternative embodiments of the gaming device of the present invention.

Fig. 2 is a schematic block diagram of the electronic configuration of one embodiment of the gaming device of the present invention.

Fig. 3 is a front elevation view of a display device having a plurality of video reels and a transformable wild symbol on one of the reels.

Fig. 4 is a front elevation view of a display device in which the transformable wild symbol displayed on the reel is alternated into a wild state.

Fig. 5 is a front elevation view of a display device in which the transformable wild symbol alternated into the wild state is transformed into a wild symbol.

Fig. 6 is a front elevation view of a display device which includes dice type transformable wild symbols on a set of reels.

Fig. 7 is a front elevation view of a display device in which certain transformable wild symbols are alternated into a wild state and transformed into a wild symbol.

Figs. 8A and 8B are front elevation views of a display device in which one transformable wild symbol is alternated and transformed into wild symbols.

Fig. 9 is a front elevation view of a display device displaying a set of cards having a transformable wild symbol.

Fig. 10 is a front elevation view of a display device in which a card is transformed into a wild card.

Fig. 11 is a front elevation view of a display device displaying a set of cards.

Fig. 12 is a front elevation view of a display device displaying a set of cards wherein certain cards are transformed into wild cards.

Figs. 13A and 13B are front elevation views of a display device displaying a set of cards wherein certain cards are transformed into wild cards.

30

DETAILED DESCRIPTION OF THE INVENTION

Gaming Device and Electronics

Referring now to the drawings, and in particular to Figs. 1A and 1B, gaming device 10a and gaming device 10b illustrate two possible cabinet styles and display arrangements and are collectively referred to herein as gaming device 10. The present invention includes the transformable wild symbol(s) being implemented in a game as described below being a stand alone game or a bonus or secondary game that coordinates with a base game. When the present invention is implemented in a bonus game, gaming device 10 in one base game can be a slot machine having the controls, displays and features of a conventional slot machine, or a video card game such as poker, blackjack, etc. The gaming device 10 may also include any bonus triggering events, bonus games as well as any progressive game coordinating with these base games. The player can operate the gaming device while standing or sitting. Gaming device 10 also includes being a pub-style or table-top game (not shown), which a player operates while sitting.

In a stand alone or a bonus embodiment, the gaming device 10 includes monetary input devices. Figs. 1A and 1B illustrate a coin slot 12 for coins or tokens and/or a payment acceptor 14 for cash money. The payment acceptor 14 also includes other devices for accepting payment, such as readers or validators for credit cards, debit cards or smart cards, tickets, notes, etc. When a player inserts money in gaming device 10, a number of credits corresponding to the amount deposited is shown in a credit display 16. After depositing the appropriate amount of money, a player can begin the game by pulling arm 18 or pushing play button 20. Play button 20 can be any play activator used by the player which starts any game or sequence of events in the gaming device.

As shown in Figs. 1A and 1B, gaming device 10 also includes a bet display 22 and a bet one button 24. The player places a bet by pushing the bet one button 24. The player can increase the bet by one credit each time the player pushes the bet one button 24. When the player pushes the bet one button 24, the number of credits shown in the credit display 16 decreases by

one, and the number of credits shown in the bet display 22 increases by one. At any time during the game, a player may "cash out" by pushing a cash out button 26 to receive coins or tokens in the coin payout tray 28 or other forms of payment, such as an amount printed on a ticket or credited to a credit card, debit card or smart card. Well known ticket printing and card reading machines (not shown) are commercially available.

Gaming device 10 also includes one or more display devices. The embodiment shown in Fig. 1A includes a central display device 30, and the alternative embodiment shown in Fig. 1B includes a central display device 30 as well as an upper display device 32. The display devices display any visual representation or exhibition, including but not limited to movement of physical objects such as mechanical reels and wheels, dynamic lighting and video images. The display device includes any viewing surface such as glass, a video monitor or screen, a liquid crystal display or any other static or dynamic display mechanism. In a video poker, blackjack or other card gaming machine embodiment, the display device includes displaying one or more cards.

The slot machine base game of gaming device 10 preferably displays a plurality of reels 34, preferably three to five reels 34, in mechanical or video form on one or more of the display devices. Each reel 34 displays a plurality of indicia such as bells, hearts, fruits, numbers, letters, bars or other images which preferably correspond to a theme associated with the gaming device 10. If the reels 34 are in video form, the display device displaying the video reel 34 is preferably a video monitor. Each base game, especially in the slot machine base game of the gaming device 10, includes speakers 36 for making sounds or playing music.

Referring now to Fig. 2, a general electronic configuration of the gaming device 10 for the stand alone and bonus embodiments described above preferably includes: a processor 38; a memory device 40 for storing program code or other data; a central display device 30; an upper display device 32; a sound card 42; a plurality of speakers 36; and one or more input devices 44. The processor 38 is preferably a microprocessor or microcontroller-based platform which is capable of displaying images, symbols and other indicia such

as images of people, characters, places, things and faces of cards. The memory device 40 includes random access memory (RAM) 46 for storing event data or other data generated or used during a particular game. The memory device 40 also includes read only memory (ROM) 48 for storing program code, which controls the gaming device 10 so that it plays a particular game in accordance with applicable game rules and pay tables.

As illustrated in Fig. 2, the player preferably uses the input devices 44 to input signals into gaming device 10. In the slot machine base game, the input devices 44 include the pull arm 18, play button 20, the bet one button 24 and the cash out button 26. A touch screen 50 and touch screen controller 52 are connected to a video controller 54 and processor 38. The terms "computer" or "controller" are used herein to refer collectively to the processor 38, the memory device 40, the sound card 42, the touch screen controller and the video controller 54.

In certain instances, it is preferable to use a touch screen 50 and an associated touch screen controller 52 instead of a conventional video monitor display device. The touch screen enables a player to input decisions into the gaming device 10 by sending a discrete signal based on the area of the touch screen 50 that the player touches or presses. As further illustrated in Fig. 2, the processor 38 connects to the coin slot 12 or payment acceptor 14, whereby the processor 38 requires a player to deposit a certain amount of money in to start the game.

It should be appreciated that although a processor 38 and memory device 40 are preferable implementations of the present invention, the present invention also includes being implemented via one or more application-specific integrated circuits (ASIC's), one or more hard-wired devices, or one or more mechanical devices (collectively referred to herein as a "processor"). Furthermore, although the processor 38 and memory device 40 preferably reside in each gaming device 10 unit, the present invention includes providing some or all of their functions at a central location such as a network server for communication to a playing station such as over a local area network (LAN), wide area network (WAN), Internet connection, microwave link, and the like.

With reference to the slot machine base game of Figs. 1A and 1B, to operate the gaming device 10, the player inserts the appropriate amount of tokens or money in the coin slot 12 or the payment acceptor 14 and then pulls the arm 18 or pushes the play button 20. The reels 34 then begin to spin. Eventually, the reels 34 come to a stop. As long as the player has credits remaining, the player can spin the reels 34 again. Depending upon where the reels 34 stop, the player may or may not win additional credits.

In addition to winning base game credits, the gaming device 10, including any of the base games disclosed above, may include bonus games that give players the opportunity to win credits. The gaming device 10 may employ a video-based display device 30 or 32 for the bonus games. The bonus games include a program that automatically begins when the player achieves a qualifying condition in the base game.

In the slot machine embodiment, the qualifying condition for a bonus game includes a particular symbol or symbol combination generated on a display device. As illustrated in the five reel slot game shown in Figs. 1A and 1B, the qualifying condition includes the number seven appearing on three adjacent reels 34 along a payline 56. It should be appreciated that the present invention includes one or more paylines, such as payline 56, wherein the paylines can be horizontal, diagonal or any combination thereof. In another embodiment, the qualifying condition includes a particular card combination in a video poker or blackjack game.

Transformable Wild Symbols

In one embodiment, the gaming device has three virtual reels 34a, 34b and 34c displayed within the display device 30 as illustrated in Fig. 3. The reels have a set of symbols such as the displayed symbols 68. At least one reel contains a transformable wild symbol 70. It should be appreciated that one reel could contain more than one transformable wild symbol, that a plurality of reels could contain transformable wild symbols, and that all of the reels could have transformable wild symbols. It should further be appreciated that one or more non-transformable wild symbols could also be included on the

reels in combination with one or more transformable wild symbols. The transformable wild symbol has a plurality of states. At least one of the states is a wild state and at least one of the states is a non-wild state. The transformable wild symbol also includes a wild/non-wild signal. The wild/non-wild signal includes a wild indicator 72 which indicates when the transformable wild symbol is in the wild state. The wild/non-wild signal also includes a non-wild indicator 73 which indicates when the transformable wild symbol is in the non-wild state.

In the illustrated embodiment, the transformable wild symbol 70 is in the form of a traffic signal having "GREEN" and "RED" displayed in different sections with each section having a light corresponding with the word displayed. The "GREEN" section 72 is the wild indicator. The "RED" section 73 is the non-wild indicator.

In one embodiment of the present invention, the reels spin and stop in a conventional manner. If a transformable wild symbol appears on a payline, as illustrated in Fig. 3, the processor causes the wild symbol indicator 72 and the non-wild indicator 73 to indicate the alternating between the wild and non-wild states to the player. In this embodiment, the processor causes the red and green lights or sections 72 and 73, respectively, to flash. The processor can randomly choose the wild state or the non-wild state for the transformable wild symbol 70. Eventually, the indicators stop alternating and the transformable wild symbol is in a wild or non-wild state.

In the above embodiment, the first reel includes a transformable wild symbol in the form of a traffic signal. When the reel stop spinning, the "RED" and "GREEN" indicators of the traffic light begin flashing in an alternating manner. Eventually, the "RED" and "GREEN" indicators stop flashing and either the "RED" indicator or "GREEN" indicator remains illuminated, indicating that the transformable wild symbol is in a wild state or a non-wild state.

In one embodiment, the processor predetermines upon the reel spin whether the transformable wild symbol will be in the wild state or in the non-wild state. Each transformable wild symbol can have an associated probability of being wild (or non-wild) which the processor uses to make the

determination. Each wild symbol could have the same probability or could have a different probability. The probability of being wild may also be randomly determined by the processor or selected from a pool of probabilities.

In the illustrated example, the wild indicator 72 in the form of the
5 "GREEN" light or section is shown illuminated in Fig. 4. The transformable wild symbol is in the wild state and the transformable wild symbol 70 acts as a wild symbol.

When the transformable wild symbol is in the wild state, it can substitute for any other symbol within the set of symbols used in the game. The
10 processor awards the player credits for any winning combinations and the credit amount is displayed in a credit display 16.

The processor may also inform the player that the transformable wild symbol is a wild symbol using audio messages, other visual displays, or a combination thereof. In one embodiment, the transformable wild symbol 70
15 changes into a symbol 75 including the word "WILD," as illustrated in Fig. 5.

It should be further appreciated that the gaming device of the present invention may alternatively include mechanical reels. The gaming device can display the transformable wild symbol in a wild or non-wild state by, for example, backlighting or any other suitable method. In an embodiment in
20 which the transformable wild symbol is in the form of a traffic signal, the signal would include two lights which are illuminated by the processor.

Referring now to Fig. 6, it should be appreciated that the wild/non-wild signal, which in certain embodiments includes both the wild indicator and the non-wild indicator, could be displayed in any other suitable manner to the
25 player. In one example, the transformable wild symbol is in the form of a die, wherein each face on the die is a wild indicator or a non-wild indicator. If the die has faces displaying the numbers 1 through 6, the numbers 1 through 3 may be non-wild indicators and the numbers 4 through 6 may be wild indicators. Thus, the number of wild and non wild indicators is equal. In
30 another embodiment, the number of wild and non-wild indicators could be unequal. The probability of the transformable wild symbol being wild could correspond to the relative number of wild or non-wild indicators or could be

unrelated to the number of each wild or non-wild indicators.

In another embodiment, after the reels are spun, the first reel which includes at least one transformable wild symbol stops spinning before the other reels. If the first reel includes a transformable wild symbol along a
5 payline, the indicators of the transformable wild symbol alternate as the other reels continue to spin. The player can see the indicators alternate as the other reels spin. This adds excitement and enjoyment to the game because the player knows the player has a chance at obtaining a wild symbol. When a
10 second reel stops spinning, the transformable wild symbol may simultaneously stop alternating and display either the wild indicator or non-wild indicator. Alternatively, when the third reel or final reel stops, the appropriate indicator could indicate if the transformable wild symbol is in the wild or non-wild state.

In another embodiment, more than one reel includes a transformable wild symbol displayed within the display device. In this embodiment, the
15 processor may transform more than one transformable wild symbol into a wild symbol. The transformations are performed simultaneously, successively, or in any combination thereof. The gaming device awards a player for winning combinations along any designated payline.

For example, a gaming device may have five reels and transformable
20 wild symbols in the form of dice displayed within the display device on two of the reels, as illustrated in Fig. 6. The symbols along the payline 56 are, respectively, a transformable wild symbol 70a, a heart 68b, a heart 68c, a transformable wild symbol 70b and a heart 68e. If both transformable wild symbols 70a and 70b are simultaneously transformed into wild symbols,
25 represented by symbols 75a and 75b and illustrated in Fig. 7, the user obtains an award associated with five hearts along the payline 56. If the transformable wild symbols 70a and 70b are transformed successively, the gaming device awards the player for each winning combination which results from the individual transformations. First, the gaming device awards the player for a
30 three heart combination including the transformable wild symbol 75a in combination with the first heart symbol 68b and second heart symbol 68c as further illustrated in Fig. 8A. The gaming device then awards the player for a 4

heart combination; that is, for the first, second and third hearts 68b, 68c and 68e in combination with the transformable wild symbol 72b, as further illustrated in Fig. 8B. It should thus be appreciated that the symbols can be transformed simultaneously, successively, or in any combination thereof. It should also be further appreciated that multiple transformable wild symbols could be on each reel and that the indicators of the transformable wild symbols may alternate in various combinations as contemplated by the present invention.

It should also be appreciated that the transformable wild symbols could be employed in other base or in bonus games. For example, in one embodiment, the display device provides a video display for a gaming scheme involving cards 80a through 80e, as illustrated in Fig. 9. Each card is capable of being or displaying a transformable wild symbol 70. Card 80d includes a transformable wild symbol 70 in the form of a coin. The transformable wild symbol displays the wild indicator 72 in the form of an "H" for heads. Although not shown, the non-wild indicator in this embodiment would be a "T" for tails. The processor transforms the card 80d into a wild card 82, as illustrated in Fig. 10 when in the wild state. If the player obtains a winning combination as a result of the wild card, the gaming device awards the player accordingly. In one embodiment, the processor signals to the player that the card is a wild card by displaying the word "WILD." In another embodiment, the card flashes. Any other visual or audio means can also be implemented to distinguish the wild card from non-wild cards.

It should also be appreciated that more than one card can include a transformable wild symbol. In this embodiment, the processor transforms the cards into wild cards either simultaneously or successively.

For example, a set of cards 80a through 80e are displayed in Fig. 11. The first card 80a and the third card 80c have transformable wild symbols 70a and 70b. If both transformable symbols are in a wild state and the processor transforms the first and third cards into wild cards 82a and 82b simultaneously and the player obtains a straight as illustrated in Fig. 12.

If the first and third cards 80a and 80c are transformed successively,

the gaming device awards the player for any of the separate winning combinations. Card 80a becomes a wild card 82a and substitutes for a Queen as illustrated in Fig. 13A. The player then has 3 Queens. Next, card 80c becomes a wild card 82b and substitutes for an Ace, providing the player with a pair of Aces as illustrated in Fig. 13B. When the third card 80c transforms into a wild card, the first card 80a is not a wild card.

The present invention also contemplates the transformable wild symbol having additional indicators corresponding to additional states. For example, the transformable wild symbol could include a repeat indicator, wherein if the repeat indicator is obtained, the processor could re-determine whether the symbol is wild or not wild. In the traffic signal example, the repeat indicator could be a "YELLOW" light or section.

In another embodiment, the transformable wild symbol has a plurality of states which correspond to different types of payouts. In an example, the transformable wild symbol is in the form of a traffic signal having three lights or sections, i.e., "RED", "YELLOW" and "GREEN." The "RED" section is a non-wild indicator. The "GREEN" section is a wild indicator. The "YELLOW" section is a limited wild indicator which corresponds to a limited wild state. For example, if the "YELLOW" section is illuminated on the transformable wild symbol, the processor limits the type of payout based on a set of conditions. In one example, the transformable wild symbol substitutes for only a selected group of symbols implemented in the game such as only matching hearts in the reel embodiment. The processor may randomly choose the conditions or the conditions could be pre-determined. In a video poker embodiment, a transformable wild symbol in a limited wild state may for instance substitute for only half of the cards implemented by the gaming device, such as all diamonds and hearts. In other embodiments, the processor conditions the amounts paid for winning combinations resulting from transformation of the transformable wild symbol into a limited wild symbol.

In another embodiment, when the transformable wild symbol is in a limited wild state, the processor provides the player with an additional spin of the reels. For example, the player spins the reels. The transformable wild

symbol is in the form of a die. The die has 6 faces displaying the numbers 1-6. Numbers 1 and 2 are non-wild indicators. Numbers 5 and 6 are wild indicators. Numbers 3 and 4 are limited wild indicators. The limited wild indicators correspond to an additional spin for a player. Similarly, in a video
5 poker embodiment, a 3 or 4 displayed on a transformable wild symbol in the form of a die corresponds to a re-dealing of the cards. It should be appreciated that other conditions and other states are contemplated by the present invention.

In a further embodiment of the present invention, the transformable wild
10 symbol(s) are not pre-associated, dedicated or predetermined. Rather, the processor randomly determines which, if any, of the symbols displayed to the player will be transformable wild symbols. Thus, any of the symbols on the reels could be transformable wild symbols and could be evaluated by the processor to determine if that symbol is in the wild state. Additionally, multiple
15 symbols on the reels could be randomly selected by the processor to be transformable wild symbols.

In another embodiment of the present invention the transformable wild symbol(s) could roam on a display in a pattern or sequence or randomly, wherein the processor randomly determines if each symbol reached in the
20 roaming or random determination transforms into a wild symbol. It should also be appreciated that since any symbol may be a transformable wild symbol, the wild indicator may or may not be part of the symbol.

A further embodiment of the present invention includes an activator symbol. In this embodiment, the processor does not determine if a
25 transformable wild symbol will be wild until an activator symbol is also displayed to the player on the reels. When the activator symbol is displayed, the processor activates the transformable wild symbol which is illustrated by the symbol alternating from the wild indicator to the non-wild indicator (e.g., flashing from red to green) until one of the states is finally indicated. Each
30 activator could activate one or more transformable wild symbols, and each transformable symbol may be activated by one or more activator symbols.

In a further embodiment, the present invention is employed in a bonus

game and a plurality of or all of the symbols are transformable wild symbols. In this embodiment, the processor simultaneously or sequentially determines if each symbol which is a transformable wild symbol is in the wild state or the non-wild state and provides the appropriate awards based on the outcomes.

5 In a further embodiment of the present invention, the gaming device provides at least two player selectable selections associated with at least one transformable wild symbol. The processor randomly associates the non-wild state with one selection and the wild state with another selection. The player picks one of the selections and the state associated with the picked selection
10 is the state of the wild symbol. The processor accordingly makes the appropriate transformation based on the player's selection.

 It should be appreciated that the transformable wild symbols or cards of the present invention, when in the wild state, may transform into any of the other symbols or cards or into less than all of the other symbols or cards. For
15 instance, the transformable wild symbol when in the wild state could transform into a limited number of symbols or cards such as a pre-defined, or randomly determined sub-set or group of the symbols or cards.

 While the present invention is described in connection with what is presently considered to be the most practical and preferred embodiments, it
20 should be appreciated that the invention is not limited to the disclosed embodiments, and is intended to cover various modifications and equivalent arrangements included within the spirit and scope of the claims. Modifications and variations in the present invention may be made without departing from the novel aspects of the invention as defined in the claims, and this application
25 is limited only by the scope of the claims.

The embodiments of the invention in which an exclusive property or privilege is claimed are defined as follows:

1. A gaming device comprising:
 - a processor;
 - a plurality of reels controlled by the processor;
 - a plurality of symbols on the reels; and
 - a transformable wild symbol on one of the reels, said transformable wild symbol having a plurality of states including a wild state and a non-wild state, wherein in the wild state the transformable wild symbol functions as one of the other symbols, and said transformable wild symbol having a wild indicator that indicates to a player that the transformable wild symbol is in a wild state and a non-wild indicator that indicates to the player that the transformable wild symbol is in a non-wild state.
2. The gaming device of Claim 1, wherein the transformable wild symbol can substitute for any of the plurality of the symbols when the transformable wild symbol is in the wild state.
3. The gaming device of Claim 1, wherein the transformable wild symbol can substitute for a limited number of the symbols when the transformable wild symbol is in the wild state.
4. The gaming device of Claim 1, wherein a plurality of reels each include at least one transformable wild symbol.
5. The gaming device of Claim 1, wherein each reel includes at least one transformable wild symbol.
6. The gaming device of Claim 1, wherein the processor randomly determines if the transformable wild symbol is in the wild state or the non-wild

state.

7. The gaming device of Claim 6, which includes a probability of the transformable wild symbol being in the wild state associated with said transformable wild symbol, wherein said processor bases said determination on said probability.

8. The gaming device of Claim 7, wherein the probability is greater than one percent.

9. The gaming device of Claim 1, wherein the processor predetermines if the transformable wild symbol is in a wild state or a non-wild state.

10. The gaming device of Claim 1, wherein the reels are video reels and which includes a display device controlled by the processor for displaying the video reels.

11. The gaming device of Claim 1, which includes a storage medium accessible by the processor.

12. The gaming device of Claim 11, wherein the storage medium includes instructions for causing the processor to:

- (a) spin the reels;
- (b) stop one of the reels;
- (c) display the transformable wild symbol on said stopped reel;
- (d) display said transformable wild symbol alternating between said wild and non-wild states using the wild indicator and the non-wild indicator; and
- (e) indicate that the transformable wild symbol is in one of the states using the wild indicator or the non-wild indicator.

13. The gaming device of Claim 11, which further includes instructions for causing the processor to continue to spin the other reels after the reel with the transformable wild symbol stops.

14. The gaming device of Claim 13, which further includes instructions for causing the processor to indicate the state of the transformable wild symbol and stop one of the other reels within a predetermined period of time.

15. The gaming device of Claim 14, which further includes instructions for causing the indication of the state of the transformable wild symbol and stopping of one of the reels to occur simultaneously.

16. The gaming device of Claim 1, which includes at least one activator symbol on said reels, wherein the processor randomly determines if the transformable wild symbol is in the wild state or non-wild state when the activator is displayed to the player.

17. The gaming device of Claim 1, which includes at least two player selectable selections, wherein the player's pick of one of the selections determines if the transformable wild symbol is in the wild state or the non-wild state.

18. A gaming device comprising:
a display device;
a processor which communicates with the display device;
a set of video reels displayed by said display device;
a plurality of symbols on said reels;
a transformable wild symbol on at least one of said reels, said transformable wild symbol having a wild state and a non-wild state, wherein in the wild state the transformable wild symbol functions as one of the other symbols;

a wild signal indicator which indicates to a player if the transformable wild symbol is in the wild state or the non-wild state; and

a probability of being in the wild state associated with the transformable wild symbol, wherein said processor determines if the transformable wild symbol is in the wild state or non-wild state based on the probability associated with the transformable wild symbol when the transformable wild symbol is obtained by the player.

19. The gaming device of Claim 18, wherein the transformable wild symbol on the reels includes the wild signal indicator.

20. The gaming device of Claim 19, wherein the wild signal indicator includes a wild indicator and a non-wild indicator controlled by the processor.

21. The gaming device of Claim 18, which includes a plurality of transformable wild symbols on the reels and a probability of being in a wild state associated with each transformable wild symbol.

22. The gaming device of Claim 21, wherein at least two of the probabilities are the same.

23. The gaming device of Claim 21, wherein at least two of the probabilities are different.

24. A gaming device comprising:

a display device;

a processor which communicates with the display device; and

a plurality of cards adapted to be selected by the processor and displayed by the display device, wherein at least one of the cards is adapted to be a transformable wild card, said transformable wild card having a wild state and a non-wild state and further having a wild indicator which indicates to a player that

the transformable wild card is in the wild state or the non-wild state.

25. The gaming device of Claim 24, wherein the transformable wild card is adapted to substitute for any of the plurality of cards when the transformable wild card is in the wild state.

26. The gaming device of Claim 24, wherein the transformable wild card is adapted to substitute for a limited number of the plurality of cards when the transformable wild card is in the wild state.

27. The gaming device of Claim 24, which includes a plurality of transformable wild cards.

28. The gaming device of Claim 24, wherein the processor randomly determines if the transformable wild card is in a wild state.

29. The gaming device of Claim 24, which includes a probability of the transformable wild card being in the wild state associated with said transformable wild card, wherein the processor bases such determination on said probability.

30. The gaming device of Claim 29, wherein the probability is greater than one percent.

31. The gaming device of Claim 24, wherein said transformable wild card includes a limited wild state.

32. A gaming device comprising:
a display device;
a processor in communication with said display device;
a plurality of cards adapted to be selected by the processor and displayed

by said display device;

at least one of said cards being a transformable wild card having a wild state and a non-wild state, said transformable wild card further having a wild indicator which indicates if the transformable wild card is in a wild state or a non-wild state; and

a probability of being in the wild state associated with the transformable wild card, wherein the processor determines if the transformable wild card is in the wild state or non-wild state based on the probability associated with the transformable wild card.

33. The gaming device of Claim 32, which includes a plurality of transformable wild cards and a probability of being in the wild state associated with each transformable wild card.

34. The gaming device of Claim 33, wherein at least two of the probabilities are the same.

35. The gaming device of Claim 33, wherein at least two of the probabilities are different.

36. A method for providing a wagering game having a wild symbol, said method comprising the steps of:

- (a) displaying a set of reels;
- (b) displaying a plurality of symbols on said reels;
- (c) randomly displaying a transformable wild symbol on one of the reels, said transformable wild symbol having a wild state and a non-wild state, said transformable wild symbol further having a wild signal indicator which indicates if the transformable wild symbol is in the wild state or the non-wild state; and
- (d) indicating to the player if said transformable wild symbol is in the wild state or the non-wild state.

37. The method of Claim 36, which includes the step of randomly determining whether the transformable wild symbol is the wild state or the non-wild state based on a probability of being wild associated with the transformable wild symbol.

38. The method of Claim 36, which includes the step of displaying to the player the transformable wild symbol alternating between the wild state and the non-wild state before indicating to the player if the transformable wild symbol is in the wild state or non-wild state.

39. The method of Claim 38, which includes the step of displaying to the player the transformable wild symbol alternating between the wild state and the non-wild state when the reels stop spinning.

40. The method of Claim 38, which includes the step of displaying to the player the transformable wild symbol alternating between the wild state and the non-wild state when the reel having the transformable wild symbol stops spinning while at least one other reel continues to spin.

41. A gaming device comprising:
a processor;
a plurality of reels controlled by the processor; and
a plurality of symbols on the reels, wherein the processor randomly determines if at least one of the symbols is a transformable wild symbol which has a wild state and a non-wild state, and randomly determines if the randomly selected transformable wild symbol is in the wild state or non-wild state, wherein the randomly selected transformable wild symbol includes a wild indicator operable to indicate if the transformable wild symbol is in the wild state or the non-wild state.

42. The gaming device of Claim 41, which includes a bonus game wherein the processor randomly determines if a plurality of the symbols are transformable wild symbols.

43. A gaming device comprising:

a processor;

a plurality of reels controlled by the processor;

a plurality of symbols on the reels, wherein at least one symbol is adapted to be a transformable wild symbol having a wild state and a non-wild state; and at least two player selectable selections associated with at least one transformable wild symbol, wherein the non-wild state is associated with one selection and the wild state is associated with another one of the selections, and wherein the player's selection of one of the selections determines if the transformable wild symbol is in the wild state or the non-wild state.

44. A gaming device comprising:

a processor;

a plurality of reels controlled by the processor;

a plurality of symbols on the reels;

a transformable wild symbol on one of the reels, said transformable wild symbol alternating between a plurality of states including a wild state and a non-wild state;

at least one activator symbol on the reels, wherein upon the occurrence of the activator on said reels, the wild state or non-wild state of the transformable wild symbol is determined; and

a wild indicator that indicates to a player that the transformable wild symbol is in a wild state, and a non-wild indicator that indicates to the player that the transformable wild symbol is in a non-wild state.

45. A gaming device comprising:

a processor;

a plurality of reels controlled by the processor;

a plurality of symbols on the reels; and

a plurality of transformable wild symbols on one of the reels, said

transformable wild symbols having a plurality of states including a wild state and a non-wild state, and said transformable wild symbols further having wild indicators that indicate to a player that the transformable wild symbols are in a wild state and non-wild indicators that indicate to the player that the transformable wild symbols are in a non-wild state.

46. The gaming device of Claim 45, wherein the wild indicators for each of the transformable wild symbols are adapted to simultaneously indicate if the transformable wild symbols are in the wild state or non-wild state.

47. The gaming device of Claim 45, wherein the wild indicators for each of the transformable wild symbols are adapted to sequentially indicate if the transformable wild symbols are in the wild state or non-wild state.

48. A gaming device comprising:

a processor;

a plurality of reels controlled by the processor;

a plurality of symbols on the reels; and

a transformable wild symbol on one of the reels, said transformable wild symbol having a plurality of states including a wild state and a non-wild state and a limited wild state, and said transformable wild symbol having a wild indicator that indicates to a player that the transformable wild symbol is in a wild state, a non-wild state or a limited wild state.

49. A gaming device comprising:

a processor;

a plurality of reels controlled by the processor;

a plurality of symbols on the reels;

a transformable wild symbol on one of the reels, said transformable wild symbol having a plurality of states including a wild state and a non-wild state, and said transformable wild symbol having a wild indicator that indicates to a

player that the transformable wild symbol is in a wild state and a non-wild indicator that indicates to the player that the transformable wild symbol is in a non-wild state; and

a storage medium accessible by the processor, wherein the storage medium includes instructions for causing the processor to: (a) spin the reels, (b) stop one of the reels, (c) display the transformable wild symbol on said stopped reel, (d) display said transformable wild symbol alternating between said wild and non-wild states using the wild indicator and the non-wild indicator, and (e) indicate that the transformable wild symbol is in one of the states using the wild indicator or the non-wild indicator.

50. A gaming device comprising:

a processor;

a plurality of reels controlled by the processor;

a plurality of symbols on the reels;

a transformable wild symbol on one of the reels, said transformable wild symbol having a plurality of states including a wild state and a non-wild state, and said transformable wild symbol having a wild indicator that indicates to a player that the transformable wild symbol is in a wild state and a non-wild indicator that indicates to the player that the transformable wild symbol is in a non-wild state; and

a storage medium accessible by the processor, said storage medium including instructions for causing the processor to continue to spin the other reels after the reel with the transformable wild symbol stops.

51. The gaming device of Claim 50, which includes instructions for causing the processor to indicate the state of the transformable wild symbol and stop one of the other reels within a predetermined period of time.

52. The gaming device of Claim 51, which includes instructions for causing the indication of the state of the transformable wild symbol and stopping

of one of the reels to occur simultaneously.

53. A gaming device comprising:

a display device;

a processor which controls the display device;

a set of video reels displayed by said display device;

a plurality of symbols on said reels;

a plurality of transformable wild symbols on the reels, said transformable wild symbols having a wild state and a non-wild state;

a wild signal indicator which indicates to a player if a transformable wild symbol is in the wild state or the non-wild state; and

a probability of being in the wild state associated with each transformable wild symbol, wherein said processor determines if the transformable wild symbol is in the wild state or non-wild state based on the probability associated with each transformable wild symbol when the transformable wild symbol is obtained by the player.

54. The gaming device of Claim 53, wherein at least two of the probabilities are the same.

55. The gaming device of Claim 53, wherein at least two of the probabilities are different.

56. A gaming device comprising:

a display device;

a processor which communicates with the display device; and

a plurality of cards adapted to be selected by the processor and displayed by the display device, wherein at least one of the cards is adapted to be a transformable wild card, said transformable wild card having a wild state and a non-wild state and a limited wild state and further having a wild indicator which indicates to a player that the transformable wild card is in the wild state, the non-

wild state or the limited wild state.

57. A gaming device comprising:

a display device;

a processor in communication with said display device;

a plurality of cards adapted to be selected by the processor and displayed by said display device;

a plurality of transformable wild cards having a wild state and a non-wild state, said transformable wild cards further having a wild indicator which indicates if the transformable wild card is in a wild state or a non-wild state; and

a probability of being in the wild state associated with the transformable wild card, wherein the processor determines if the transformable wild card is in the wild state or non-wild state based on the probability associated with the transformable wild card.

58. The gaming device of Claim 57, wherein at least two of the probabilities are the same.

59. The gaming device of Claim 57, wherein at least two of the probabilities are different.

60. A method for providing a wagering game having a wild symbol, said method comprising:

(a) displaying a set of reels;

(b) displaying a plurality of symbols on said reels;

(c) randomly displaying a transformable wild symbol alternating between a wild state and a non-wild state; and

(d) indicating to the player if said transformable wild symbol is in the wild state or the non-wild state.

61. The method of Claim 60, which includes the step of displaying to the player the transformable wild symbol alternating between the wild state and the non-wild state when the reels stop spinning.

62. The method of Claim 60, which includes the step of displaying to the player the transformable wild symbol alternating between the wild state and the non-wild state when the reel having the transformable wild symbol stops spinning while at least one other reel continues to spin.

63. A gaming device operated under control of a processor, said gaming device comprising:

a plurality of reels controlled by said processor;

a plurality of symbols on the reels;

at least one transformable wild symbol on at least one of said reels, said transformable wild symbol having a plurality of states including at least one wild state and at least one non-wild state; and

said transformable wild symbol having a plurality of indicators including at least one wild indicator adapted to indicate the wild state and at least one non-wild indicator adapted to indicate the non-wild state, wherein said processor is operable to cause the wild indicator to indicate the wild state and to cause the non-wild indicator to indicate the non-wild state,

wherein said processor is operable to determine whether the transformable wild symbol is in the wild state or the non-wild state, and if the transformable wild symbol is in the wild state the transformable wild symbol functions as at least one of the other symbols.

64. The gaming device of Claim 63, wherein said transformable wild symbol further includes at least one limited wild state and said indicators further include at least one limited wild indicator adapted to indicate the limited wild state.

65. The gaming device of Claim 63, wherein said transformable wild symbol further includes at least one repeat state and said indicators further include at least one repeat indicator adapted to indicate the repeat state.

66. The gaming device of Claim 65, wherein if the transformable wild symbol is in the repeat state the processor re-determines whether the transformable wild symbol is in the wild state or the non-wild state.

67. The gaming device of Claim 65, wherein if the transformable wild symbol is in the repeat state the processor re-determines whether the transformable wild symbol is in the wild state, the non-wild state, or the repeat state.

68. The gaming device of Claim 63, wherein the transformable wild symbol can function as any of the plurality of other symbols if the transformable wild symbol is in the wild state.

69. The gaming device of Claim 63, wherein the transformable wild symbol can function as only a limited number of the other symbols if the transformable wild symbol is in the wild state.

70. The gaming device of Claim 63, wherein the processor is operable to alternatively cause the wild indicator to indicate the wild state and the non-wild indicator to indicate the non-wild state a plurality of times.

71. The gaming device of Claim 63, wherein the processor is operable to alternatively cause the wild indicator to indicate the wild state and the non-wild indicator to indicate the non-wild state a predetermined number of times, said number of time being at least once.

72. The gaming device of Claim 63, wherein the processor determines if the transformable wild symbol is in the wild state based on a predetermined probability.

73. The gaming device of Claim 72, wherein said predetermined probability is greater than zero percent and less than one-hundred percent.

74. The gaming device of Claim 63, wherein if the transformable wild symbol is in the wild state a bonus event occurs.

75. The gaming device of Claim 63, which includes a plurality of transformable wild symbols which each include a plurality of indicators including at least one wild indicator and at least one non-wild indicator, wherein said processor is operable to cause the wild indicator of each transformable wild symbol to indicate the wild state and to cause the non-wild indicator of each transformable wild symbol to indicate the non-wild state, wherein said processor is operable to determine whether each said transformable wild symbol is in the wild state or the non-wild state, and if said transformable wild symbol is in the wild state said transformable wild symbol functions as at least one of the other symbols.

76. A gaming device operated under control of a processor, said gaming device comprising:

a plurality of reels controlled by said processor;

a plurality of symbols on the reels;

at least one transformable wild symbol on at least one of said reels, said transformable wild symbol having a plurality of states including at least one wild state, at least one non-wild state, and at least one repeat state; and

at least one indicator including a wild signal adapted to indicate the wild state, a non-wild signal adapted to indicate the non-wild state, and a repeat signal adapted to indicate the repeat state, wherein the processor is operable to determine whether the transformable wild symbol is in the wild state, the non-

wild state, or the repeat state, and if the transformable wild symbol is in the wild state the transformable wild symbol functions as at least one of the other symbols.

77. The gaming device of Claim 76, wherein said transformable wild symbol further includes at least one limited wild state and said indicator further includes a limited wild signal adapted to indicate when the transformable wild symbol is in the limited wild state.

78. The gaming device of Claim 76, wherein if the transformable wild symbol is in the repeat state, the processor re-determines if the transformable wild symbol is in the wild state or the non-wild state.

79. The gaming device of Claim 76, wherein if the transformable wild symbol is in the repeat state, the processor re-determines if the transformable wild symbol is in the wild state, the non-wild state, or the repeat state.

80. The gaming device of Claim 76, wherein if the transformable wild symbol is in the repeat state, the processor re-determines if the transformable wild symbol is in the wild state or the non-wild state for each and every occurrence of the repeat state.

81. The gaming device of Claim 76, wherein if the transformable wild symbol is in the repeat state, the processor re-determines if the transformable wild symbol is in the wild state, the non-wild state, or the repeat state for each and every occurrence of the repeat state.

82. The gaming device of Claim 76, wherein the processor sequentially re-determines if the transformable wild symbol is in the wild state, the non-wild state, or the repeat state until the transformable wild symbol is either in the wild state or the non-wild state.

83. The gaming device of Claim 76, wherein the processor sequentially re-determines if the transformable wild symbol is in the wild state, the non-wild state, or the repeat state a limited number of times.

84. The gaming device of Claim 76, wherein the processor determines if the transformable wild symbol is in the wild state, non-wild state or repeat state based on a predetermined probability.

85. The gaming device of Claim 84, wherein said predetermined probability is greater than zero percent and less than one-hundred percent.

86. A method for operating a wagering game, said method comprising:

(a) displaying a set of reels having a plurality of symbols, said symbols including a transformable wild symbol having a plurality of states including at least one wild state and at least one non-wild state, said transformable wild symbol having a plurality of indicators including at least one wild indicator and at least one non-wild indicator;

(b) activating the reels to cause a subset of said symbols to be displayed on the reels;

(c) determining whether said subset includes the transformable wild symbol, and if the subset includes the transformable wild symbol:

(i) determining if the transformable wild symbol is in the wild state or the non-wild state,

(ii) causing the wild indicator to indicate the wild state if the wild transformable symbol is in the wild state,

(iii) causing the non-wild indicator to indicate the non-wild state if the wild transformable symbol is in the non-wild state, and

(iv) causing the transformable wild symbol to function as at least one of the other symbols if the transformable wild symbol is in the wild state; and

(d) determining whether any winning combination of symbols is displayed on the reels, and providing an award if any winning combination of symbols is displayed.

87. The method of Claim 86, wherein said transformable wild symbol further includes at least one limited wild state, and which includes causing the transformable wild symbol to indicate the limited wild state if the transformable wild symbols in the limited wild state.

88. The method of Claim 86, wherein said transformable wild symbol further includes at least one repeat state, and which includes causing the transformable wild symbol to indicate the repeat state if the transformable wild symbols in the repeat state.

89. The method of Claim 88, wherein if the transformable wild symbol is in the repeat state, re-determining whether the transformable wild symbol is in the wild state or the non-wild state.

90. The method of Claim 88, wherein if the transformable wild symbol is in the repeat state, re-determining whether the transformable wild symbol is in the wild state, the non-wild state, or the repeat state.

91. The method of Claim 86, which includes alternatively causing the wild indicator to indicate the wild state and the non-wild indicator to indicate the non-wild state a plurality of times.

92. The method of Claim 86, which includes alternatively causing the wild indicator to indicate the wild state and the non-wild indicator to indicate the non-wild state a predetermined number of times.

93. The method of Claim 86, which includes causing the transformable wild symbol to function as any of the plurality of other symbols if the transformable wild symbol is in the wild state.

94. The method of Claim 86, which includes causing the transformable wild symbol to function as a limited number of the other symbols if the transformable wild symbol is in the wild state.

95. The method of Claim 86, wherein determining if the transformable wild symbol is in the wild state or the non-wild state is based on a predetermined probability.

96. The method of Claim 95, wherein said predetermined probability is greater than zero percent and less than one-hundred percent.

97. The method of Claim 86, which includes triggering a bonus event if the transformable wild symbol is in the wild state.

98. The method of Claim 86, which includes operating said method through a data network.

99. The method of Claim 98, wherein the data network is an internet.

100. A method for operating a wagering game, said method comprising:

(a) displaying a set of reels having a plurality of symbols, said symbols including a transformable wild symbol having a plurality of states including at least one wild state, at least one non-wild state, and at least one repeat state;

(b) activating the reels to cause a subset of said symbols to be displayed on the reels;

(c) determining whether said subset includes the transformable wild symbol, and if the subset includes the transformable wild symbol:

- (i) determining if the transformable wild symbol is in the wild state, the non-wild state, or the repeat state,
- (ii) indicating whether the transformable wild symbol is in the wild state, the non-wild state, or the repeat state, and
- (iii) causing the transformable wild symbol to function as at least one of the other symbols if said transformable symbol is in the wild state; and
- (d) determining whether any winning combination of symbols is displayed, and providing an award if any winning combination of symbols is displayed.

101. The method of Claim 100, wherein said transformable wild symbol further includes at least one limited wild state, and which includes indicating if the transformable wild symbol is in the limited state.

102. The method of Claim 100, which includes re-determining whether the transformable wild symbol is in the wild state or the non-wild state if the transformable wild symbol is in the repeat state.

103. The method of Claim 100, which includes re-determining whether the transformable wild symbol is in the wild state, the non-wild state, or the repeat state if the transformable wild symbol is in the repeat state.

104. The method of Claim 100, which includes repeating step (c) until the transformable wild symbol is in the wild state or the non-wild state.

105. The method of Claim 104, wherein step (c) is repeated a limited number of times.

106. The method of Claim 100, wherein determining if the transformable wild symbol is in the wild state, the non-wild state, or the repeat state is based on at least one a predetermined probability.

107. The method of Claim 106, wherein said predetermined probability is greater than zero percent and less than one-hundred percent.

108. The method of Claim 100, which includes operating said method through a data network.

109. The method of Claim 108, wherein the data network is an internet.

110. A method for operating a wagering game, said method comprising:

(a) displaying a set of reels having a plurality of symbols including at least one transformable wild symbol, wherein said transformable wild symbol has a wild state and a non-wild state;

(b) activating the reels to cause a subset of said symbols to be displayed on the reels;

(c) determining whether said subset includes the transformable wild symbol;

(d) if said subset includes the transformable wild symbol:

(i) displaying at least two player selectable selections, wherein the wild state is associated with at least one of the selections and the non-wild state is associated with at least another one of the selections,

(ii) causing a selection of one of the player selectable selections,

(iii) determining whether the transformable wild symbol is in the wild state or the non-wild state based on the selected player selectable selection, and

(iv) causing the transformable wild symbol to function as at least one of the other symbols if said transformable symbol is in the wild state; and

(e) determining whether any winning combination of symbols is displayed, and providing an award if any winning combination of symbols is displayed.

111. The method of Claim 110, which includes operating said method through a data network.

112. The method of Claim 111, wherein said data network is an internet.

113. A method for operating a wagering game, said method comprising:

(a) displaying a set of reels having a plurality of symbols, wherein said symbols include at least one activator symbol and at least one transformable wild symbol having a wild state and a non-wild state;

(b) causing a subset of said symbols to be displayed on the reels;

(c) if the subset includes the activator symbol and the transformable wild symbol:

(i) determining whether the transformable wild symbol is in the wild state or the non-wild state,

(ii) alternating an indication of the transformable wild symbol being in the wild state and the non-wild state,

(iii) indicating whether the transformable wild symbol is in the wild state or the non-wild state, and

(iv) causing the transformable wild symbol to function as at least one of the other symbols if said transformable symbol is in the wild state; and

(d) determining whether any winning combination of symbols is displayed, and providing an award if any winning combination of symbols is displayed.

114. The method of Claim 113, which includes operating said method through a data network.

115. The method of Claim 114, wherein said data network is an internet.

116. A method for operating a wagering game, said method comprising:

(a) displaying a set of reels having a plurality of symbols including a transformable wild symbol having a wild state, a non-wild state, and a limited wild state, said transformable wild symbol further having a wild indicator that indicates if the transformable wild symbol is in the wild state, the non-wild state, or the limited wild state;

(b) activating the reels to cause a subset of said symbols to be displayed on the reels;

(c) if the transformable wild symbol is displayed on the reels:

(i) determining whether the transformable wild symbol is in the wild state, the non-wild state or the limited wild state,

(ii) causing the indicator to indicate whether the transformable wild symbol is in the wild state, the non-wild state, or the limited wild state,

(iii) causing the transformable wild symbol to function as at least any of the other symbols if said transformable symbol is in the wild state, and

(iv) causing the transformable wild symbol to function as one of a limited number of the other symbols if said transformable symbol is in the limited wild state; and

(d) determining whether any winning combination of symbols is displayed, and providing an award if any winning combination of symbols is displayed.

117. The method of Claim 116, which includes operating said method through a data network.

118. The method of Claim 117, wherein said data network is an internet.

119. A method for operating a wagering game, said method comprising:

(a) providing a plurality of cards, wherein at least one of said cards is adapted to function as a transformable wild card, said transformable wild card having a wild state and a non-wild state, and said transformable wild card further

having a wild indicator that indicates whether the transformable wild card is in the wild state or the non-wild state;

- (b) displaying a subset of said cards;
- (c) determining whether said subset includes the transformable wild card;
- (d) if the subset includes the transformable wild symbols:
 - (i) determining whether the transformable wild card is in the wild state or the non-wild state,
 - (ii) causing the wild indicator to indicate if the transformable wild card is in the wild state,
 - (iii) causing the wild indicator to indicate if the transformable wild card is in the non-wild state, and
 - (iv) causing the transformable wild card to function as at least one of the other cards if said transformable card is in the wild state; and
- (e) determining whether any winning combination of cards is displayed, and providing an award if any winning combination of cards is displayed.

120. The method of Claim 119, which includes a plurality of transformable wild cards.

121. The method of Claim 119, which includes randomly determining whether the transformable wild card is in the wild state or the non-wild state.

122. The method of Claim 119, wherein determining whether the transformable wild card is in the wild state or the non-wild state is based on a predetermined probability.

123. The method of Claim 122, wherein said predetermined probability is greater than zero percent and less than one-hundred percent.

124. The method of Claim 119, which includes operating said method through a data network.

125. The method of Claim 124, wherein said data network is an internet.

FIG.1A

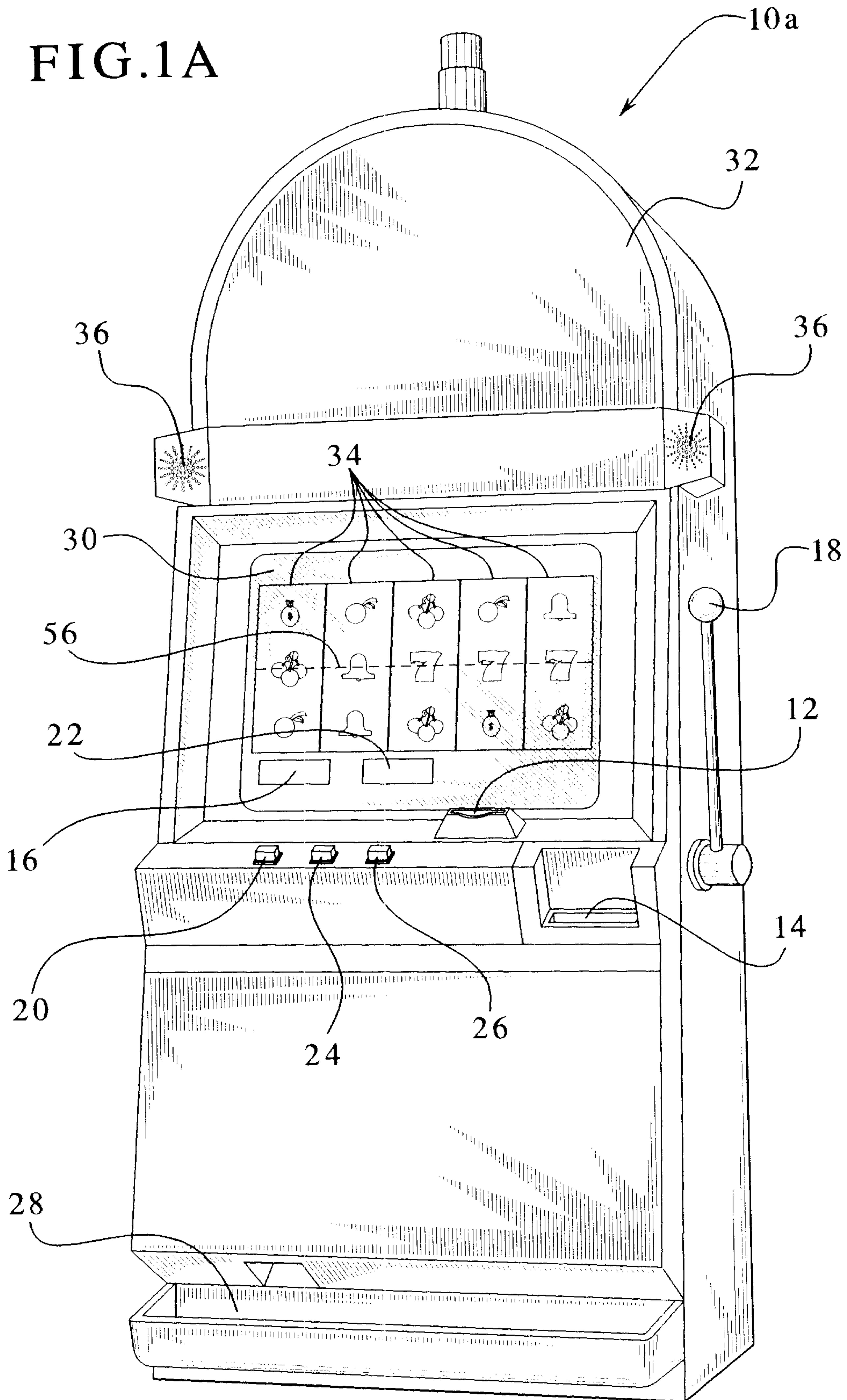

FIG.1B

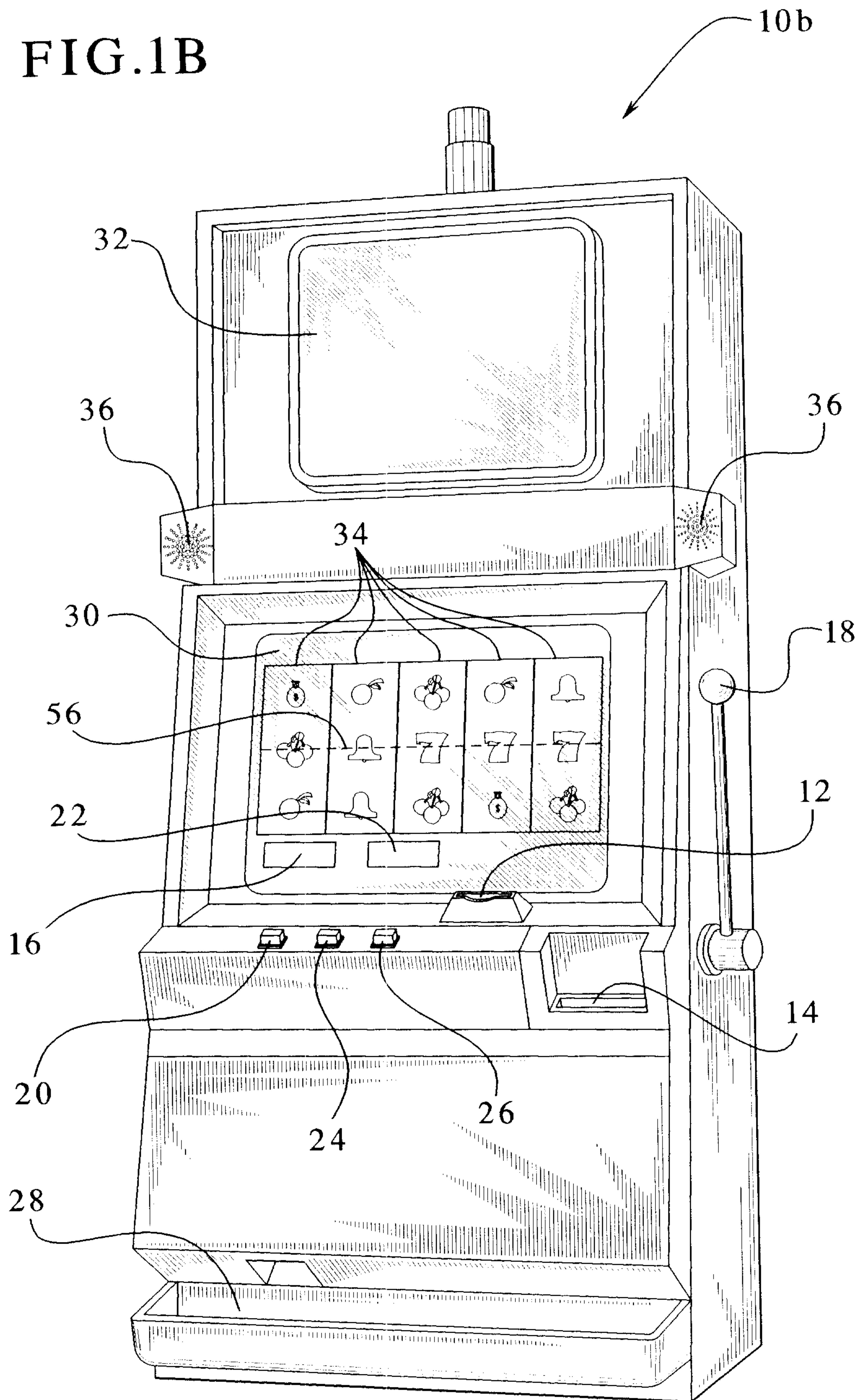

FIG. 2

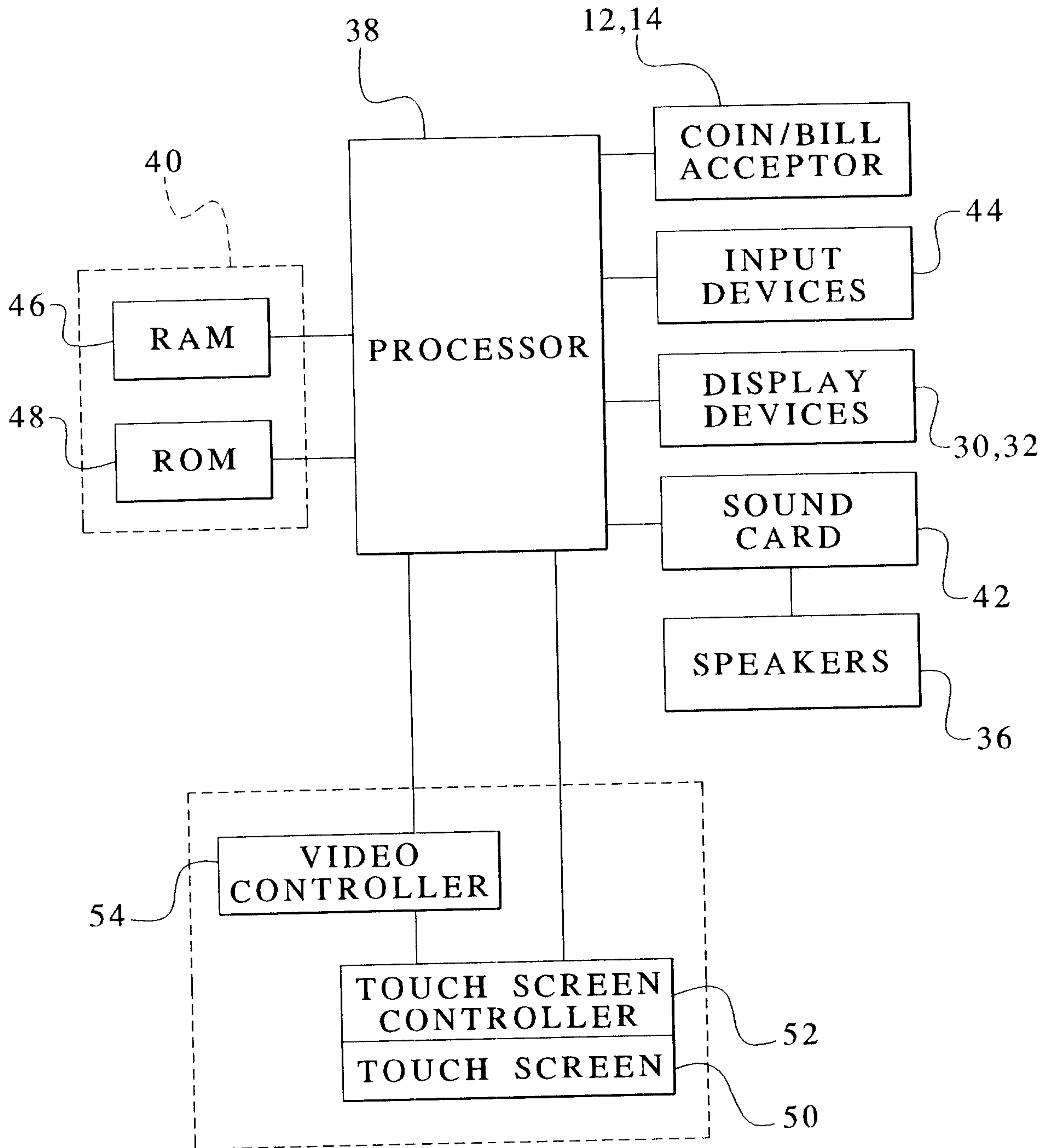

FIG. 3

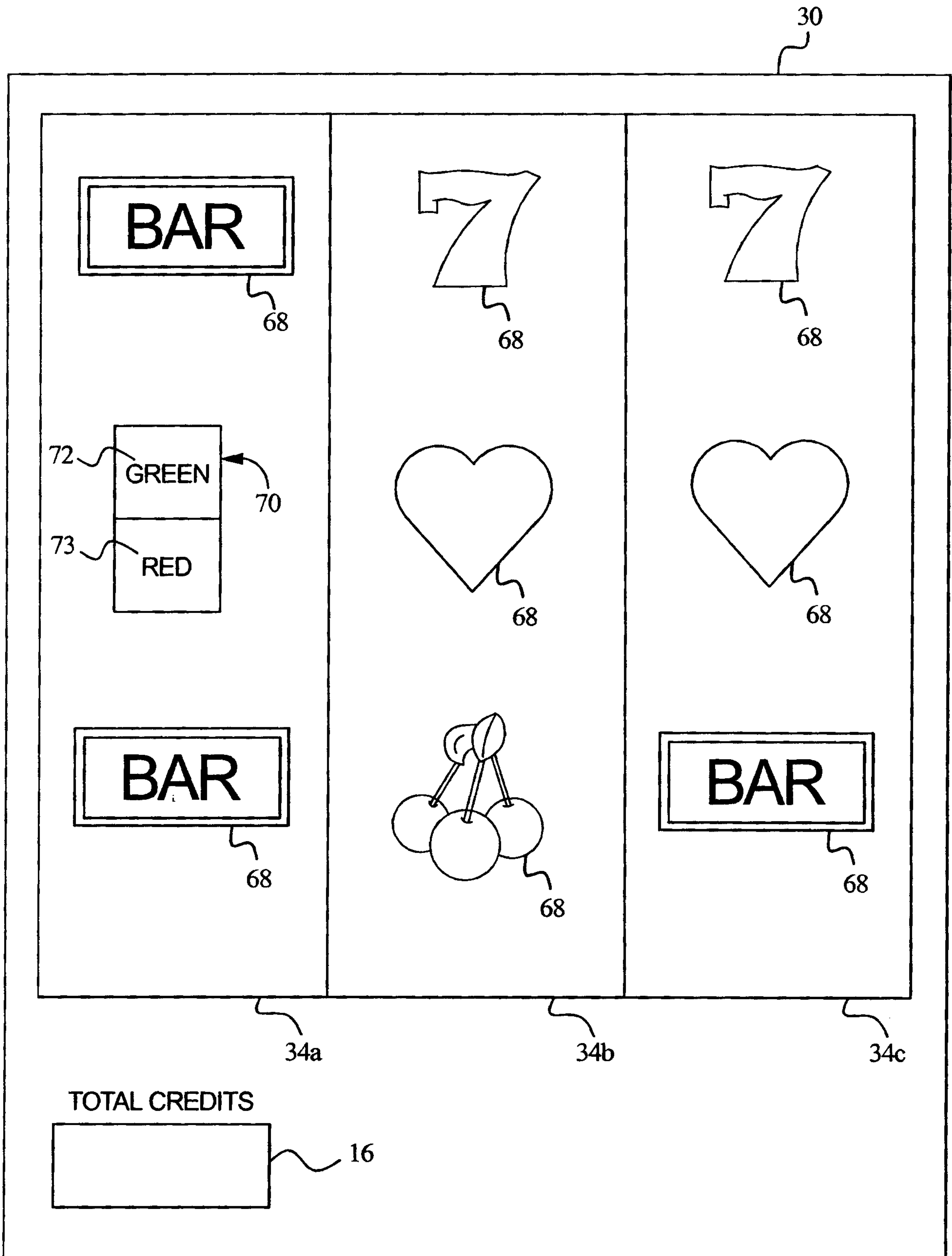

FIG. 4

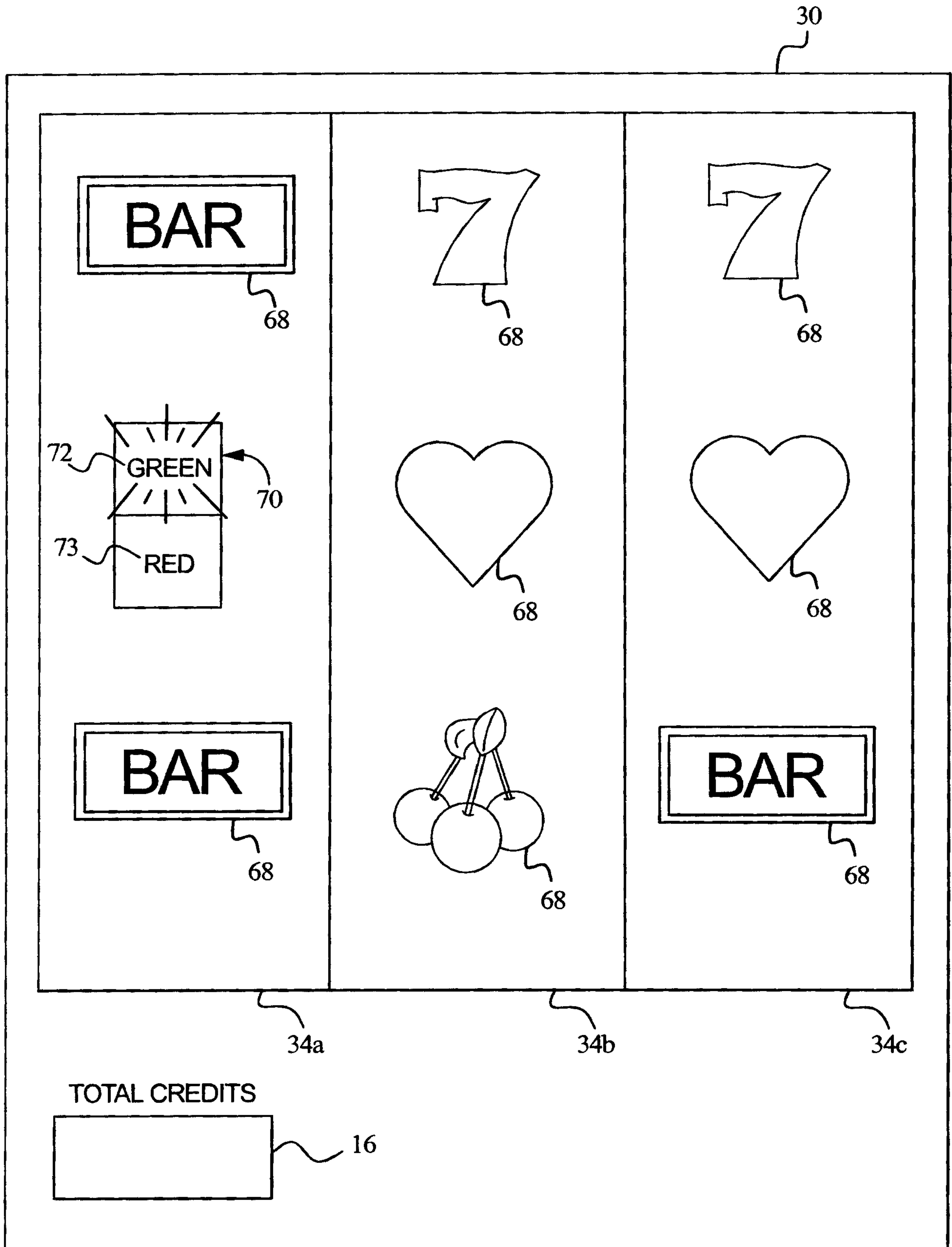

FIG. 5

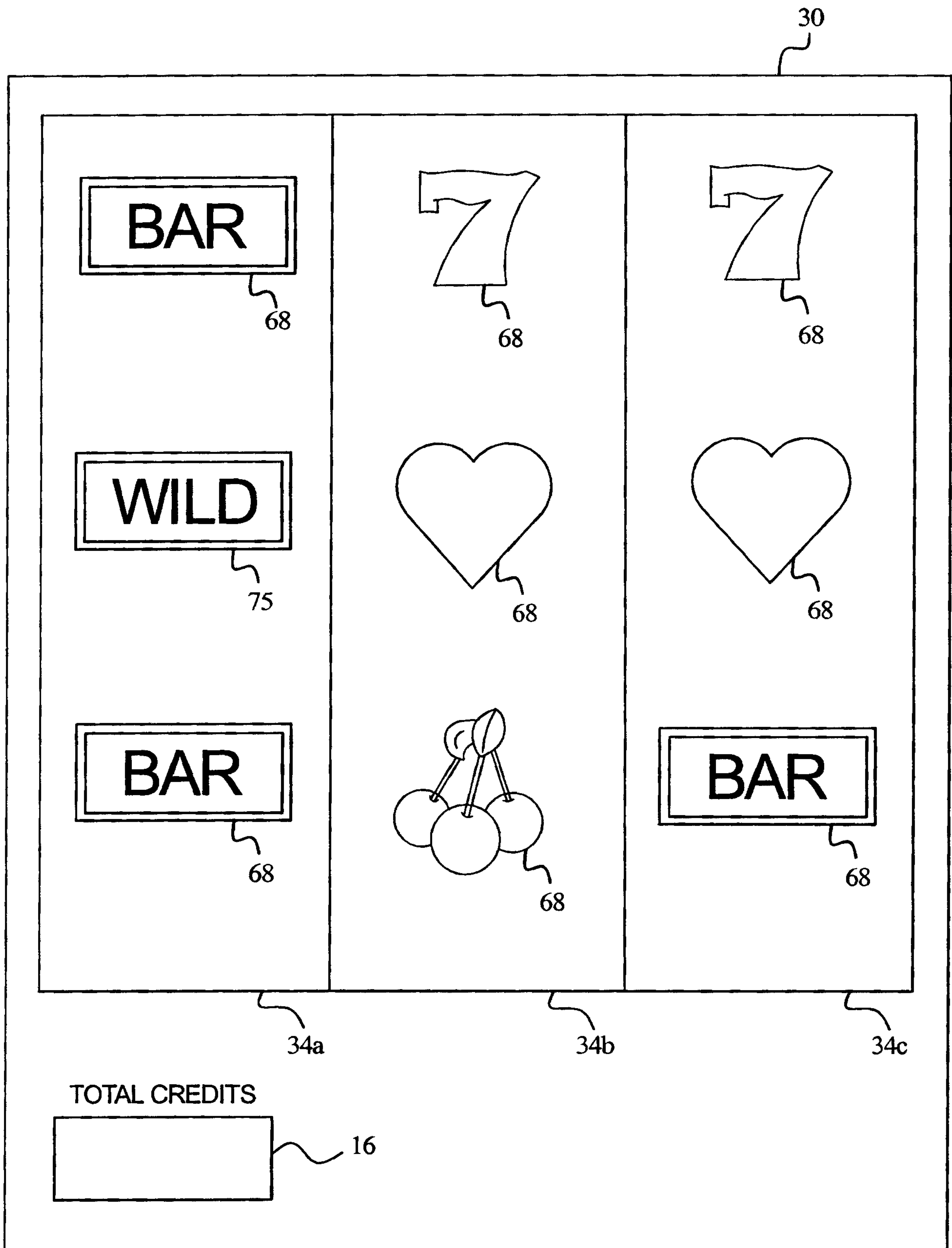

FIG. 6

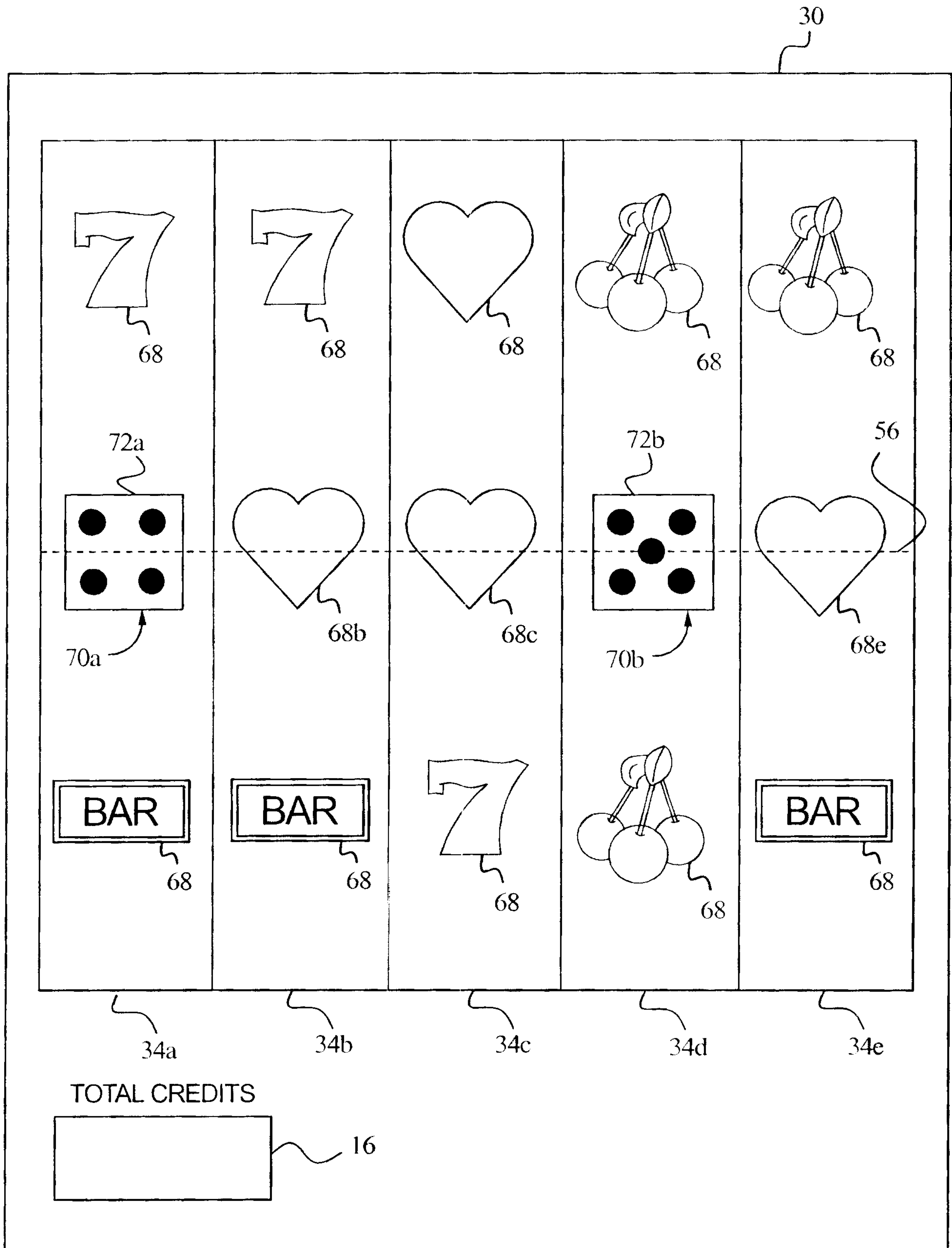

FIG. 7

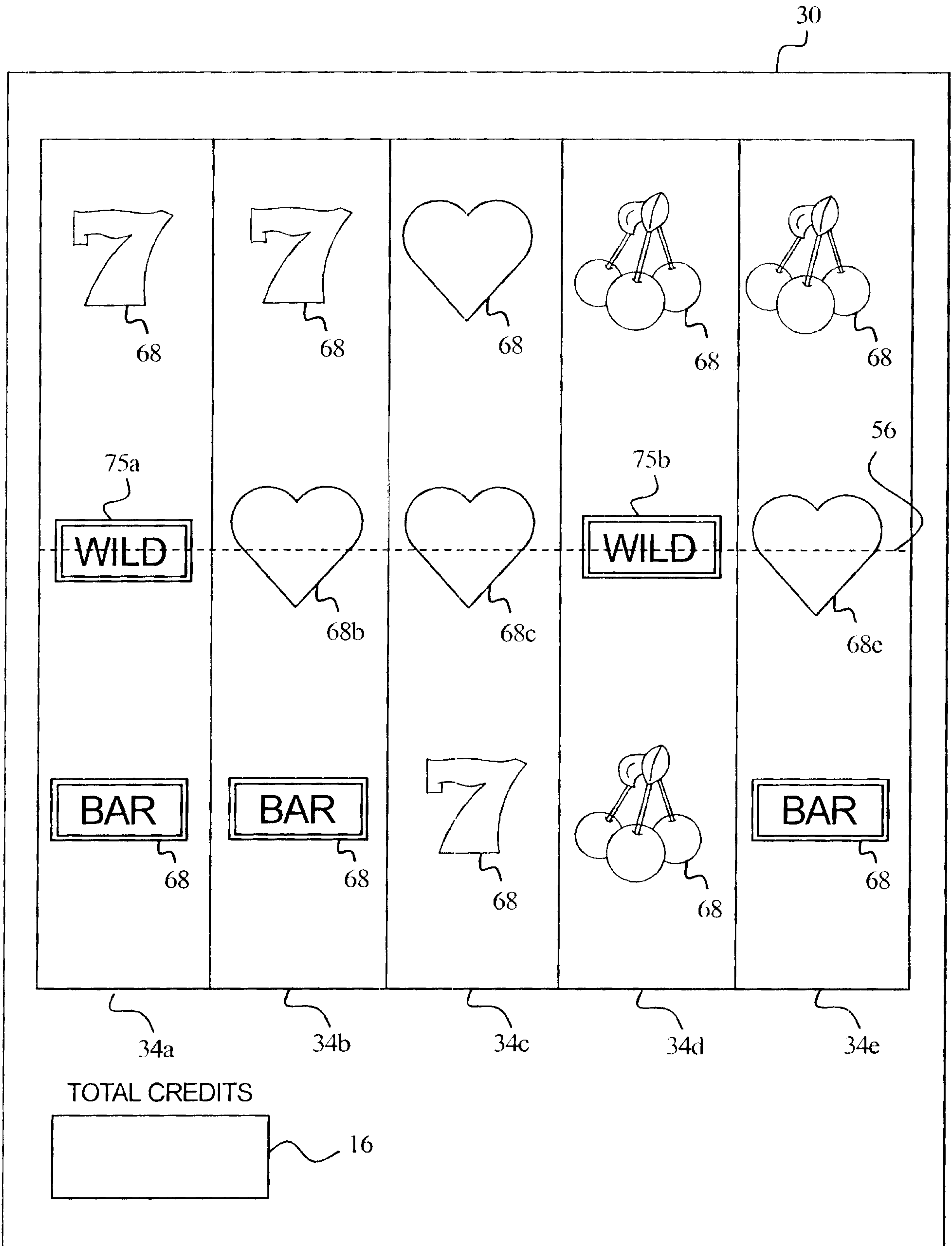

FIG. 8A

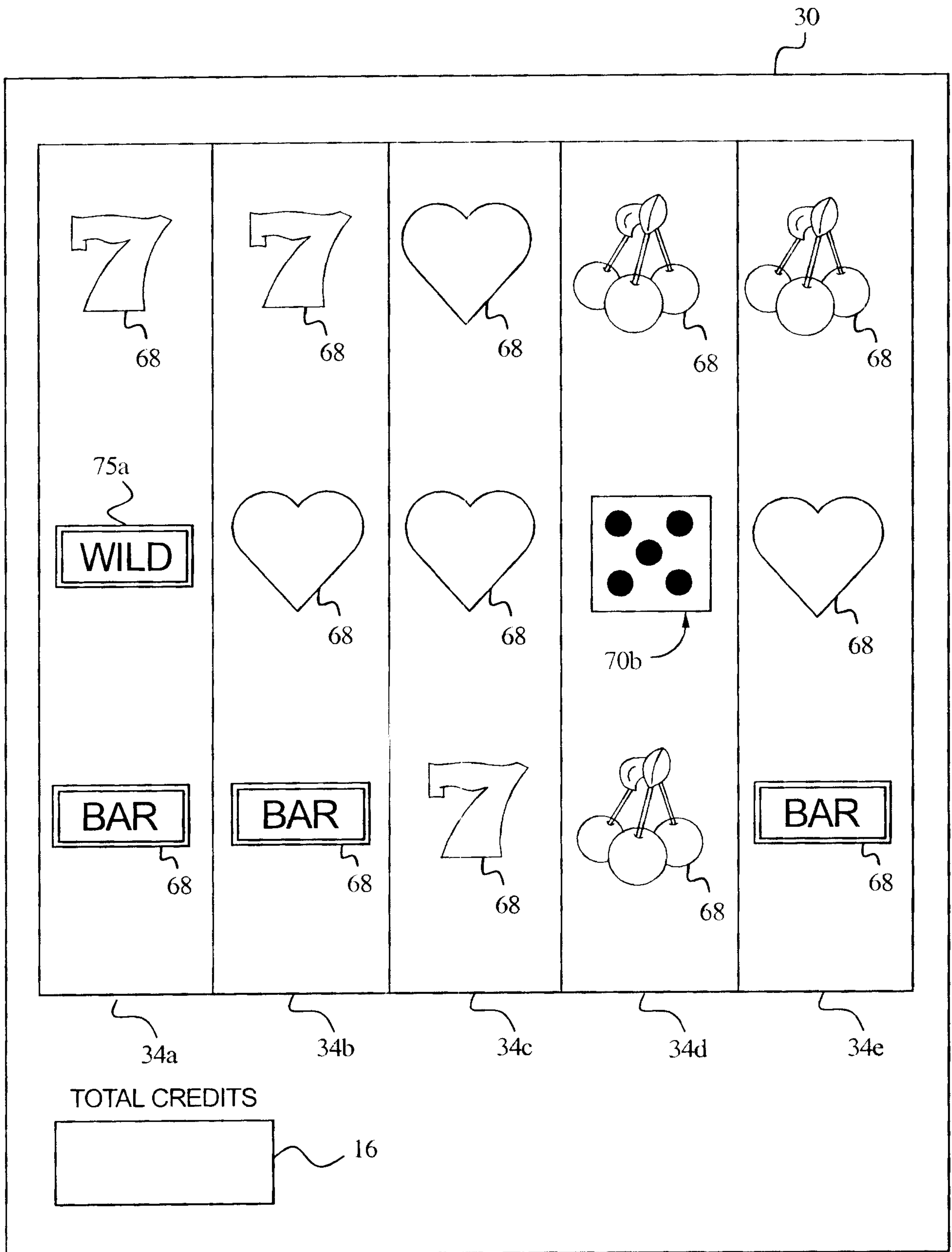

FIG. 8B

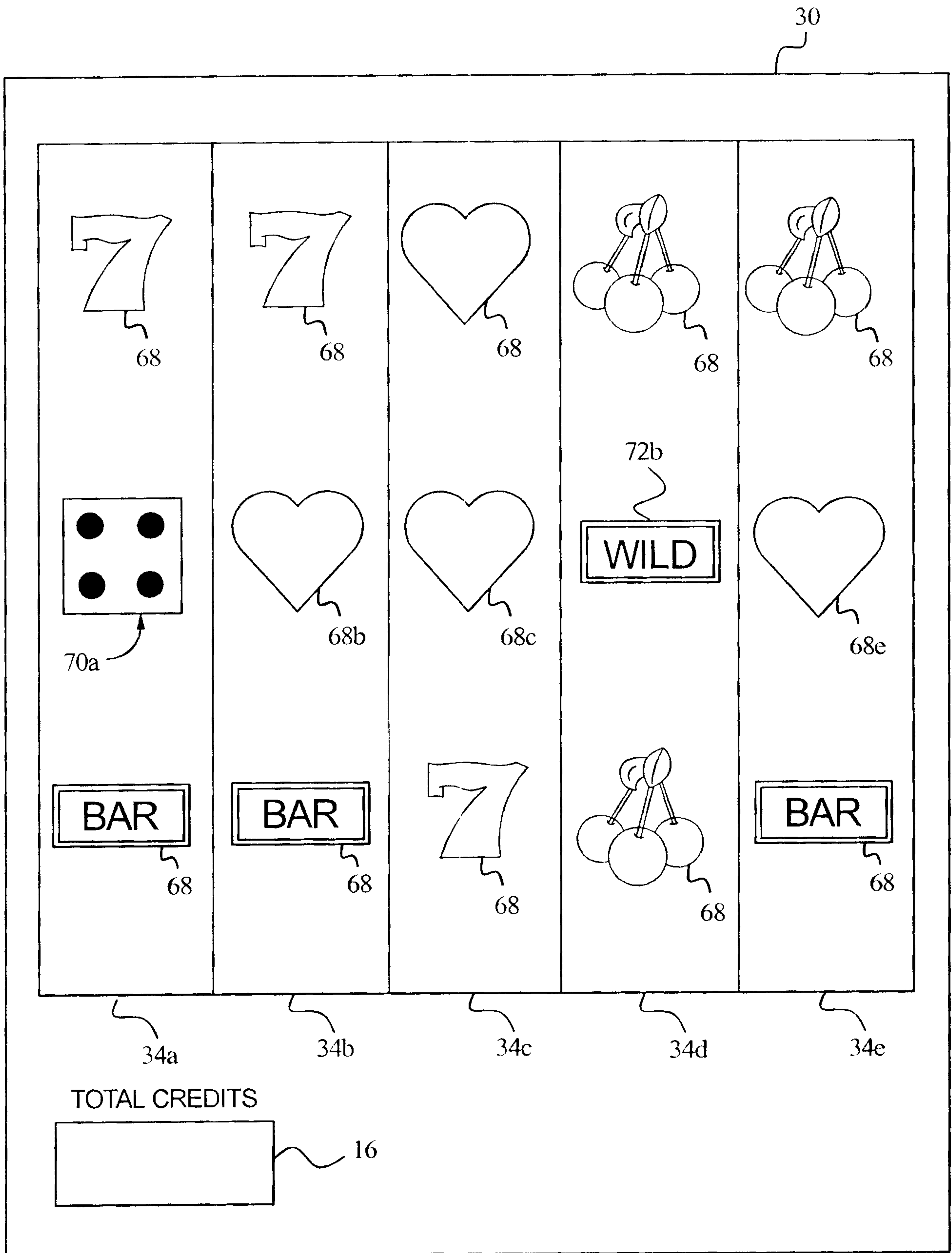

FIG. 9

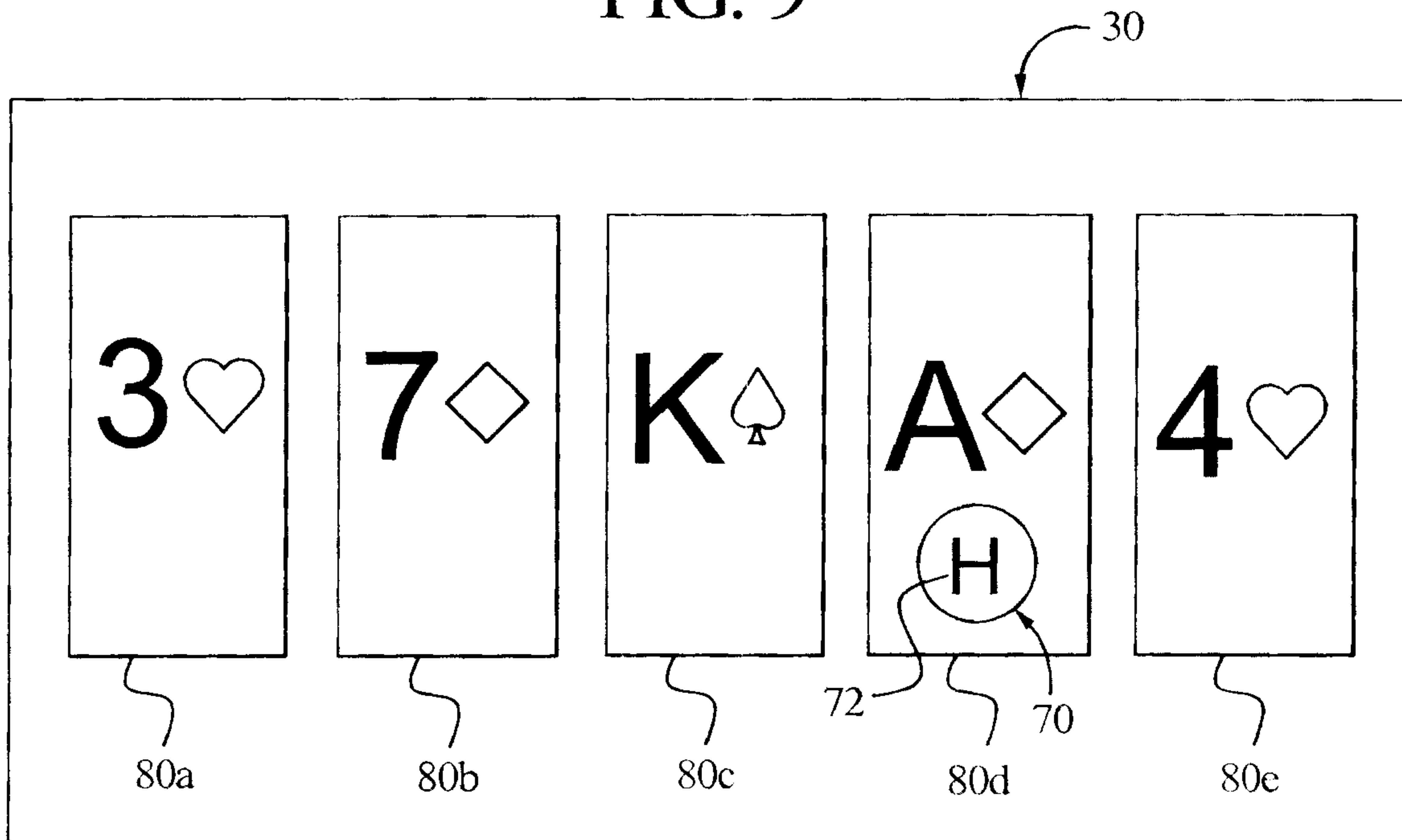

FIG. 10

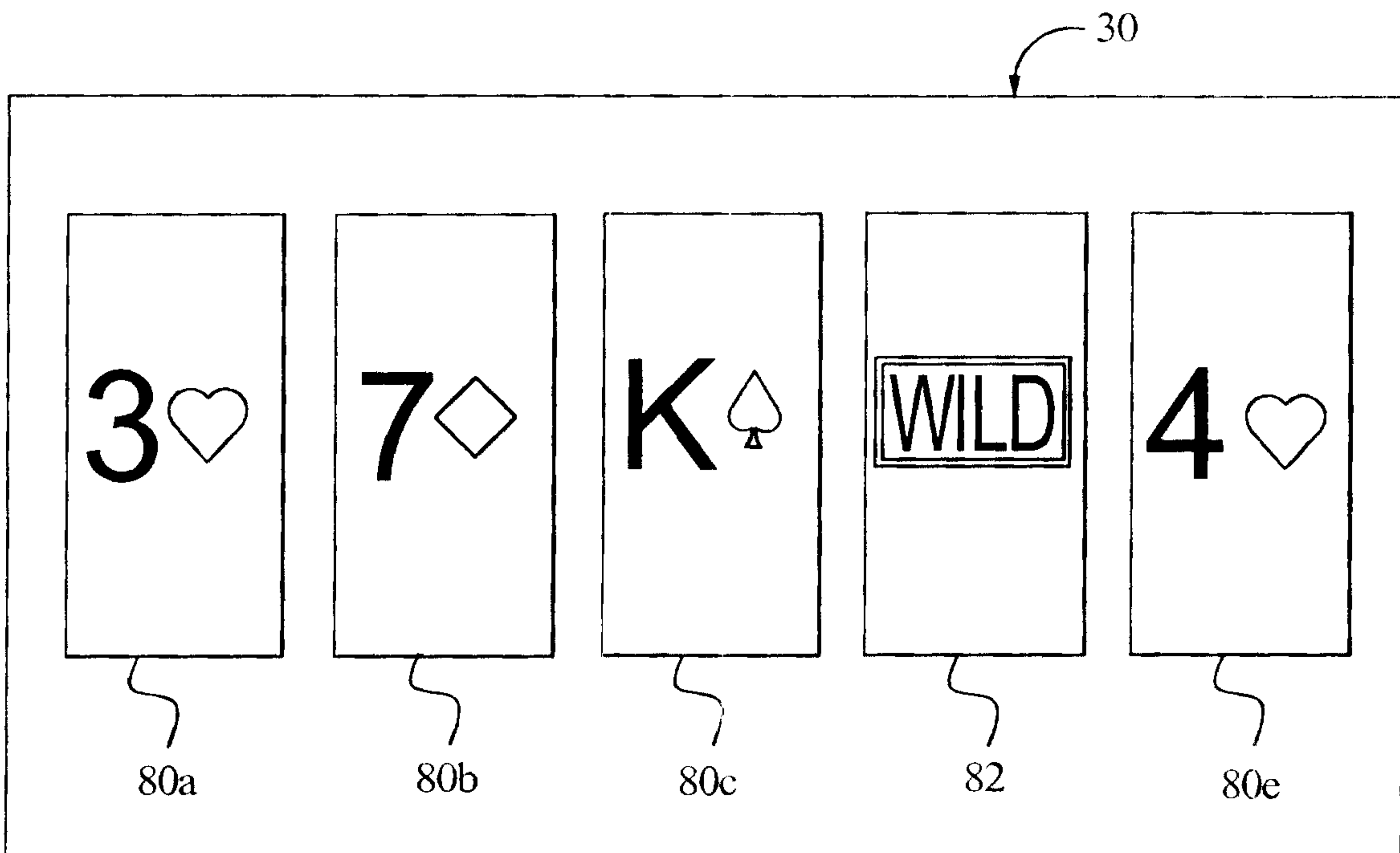

FIG. 11

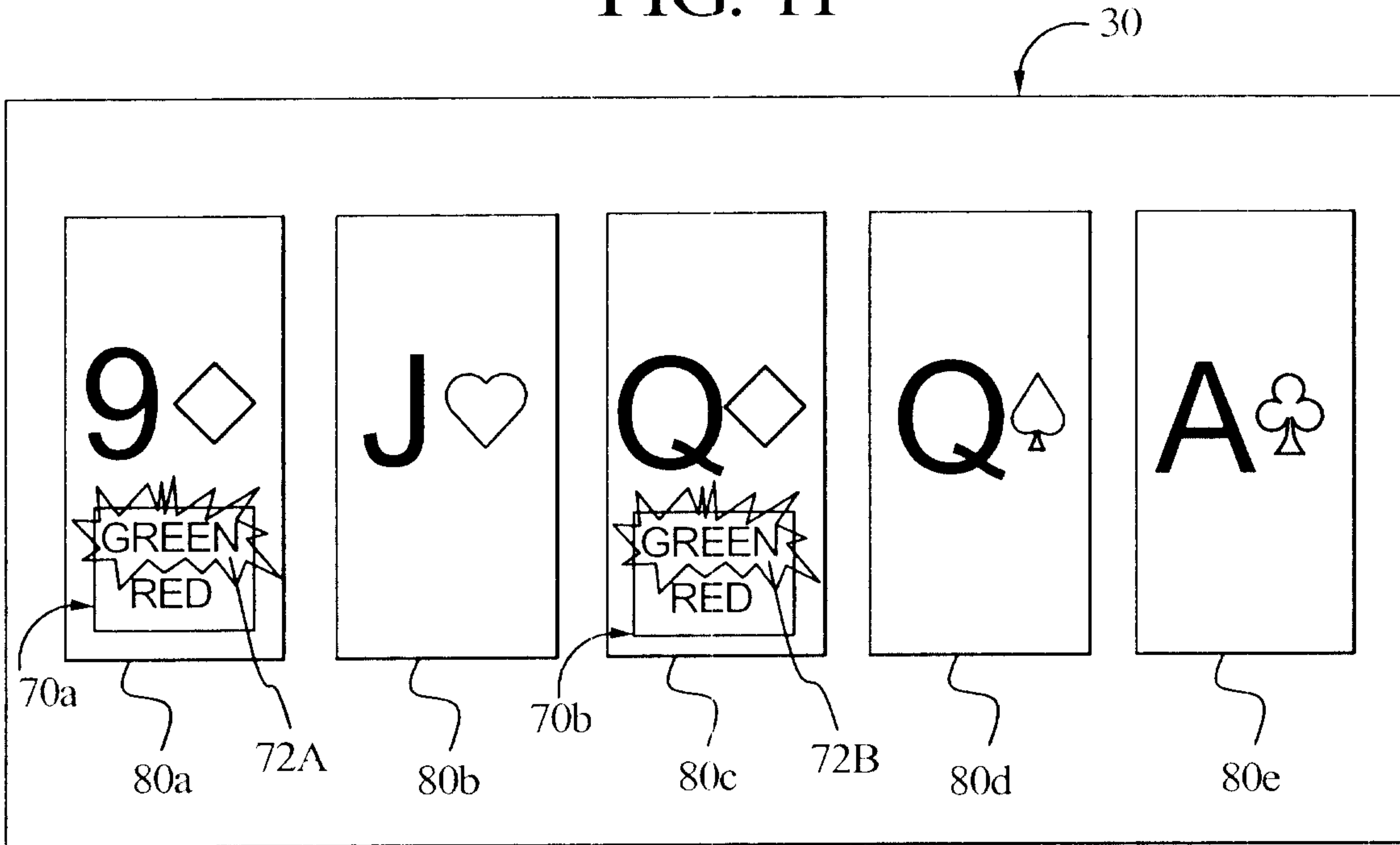

FIG. 12

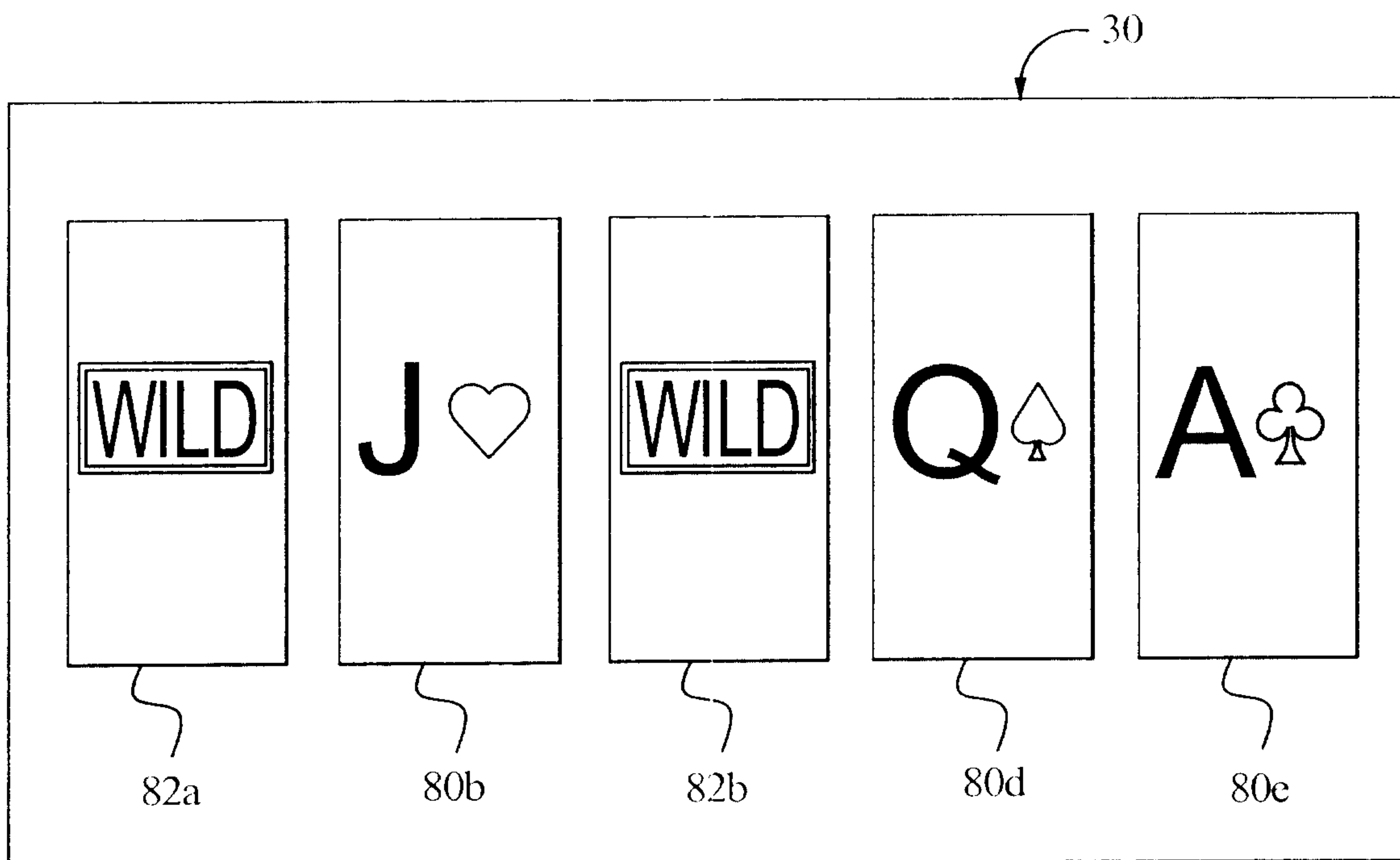

FIG. 13A

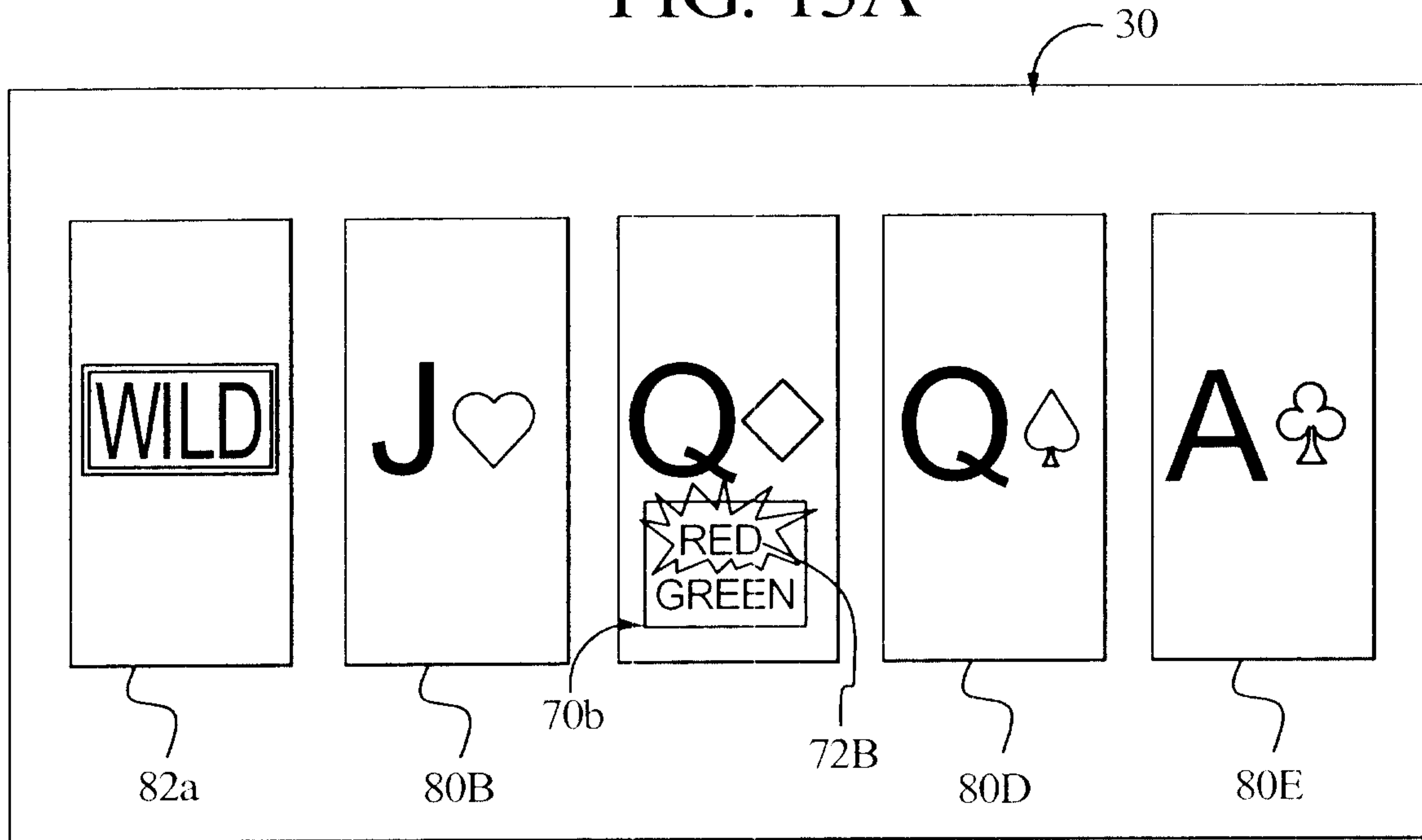
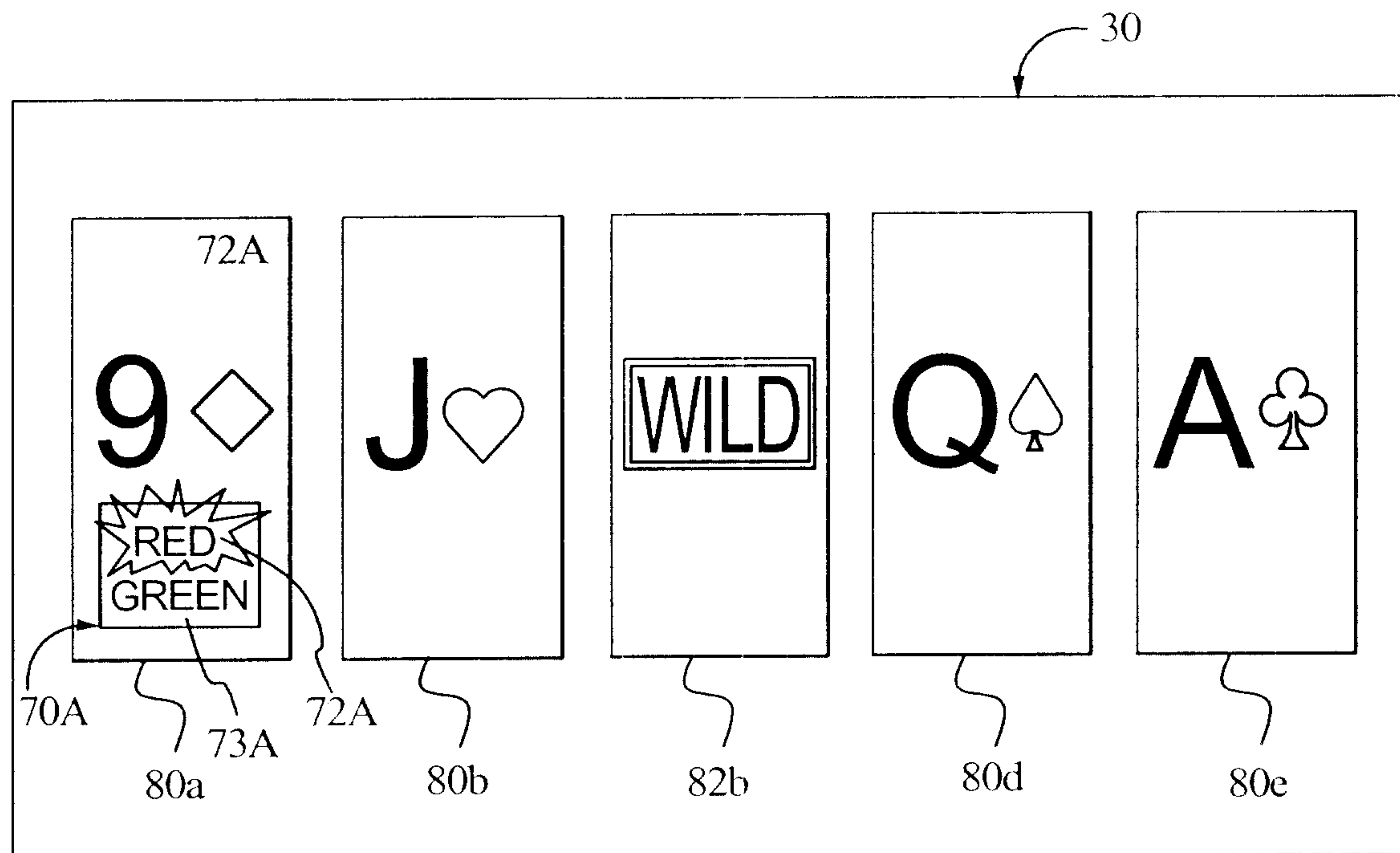

FIG. 13B





68



68



68

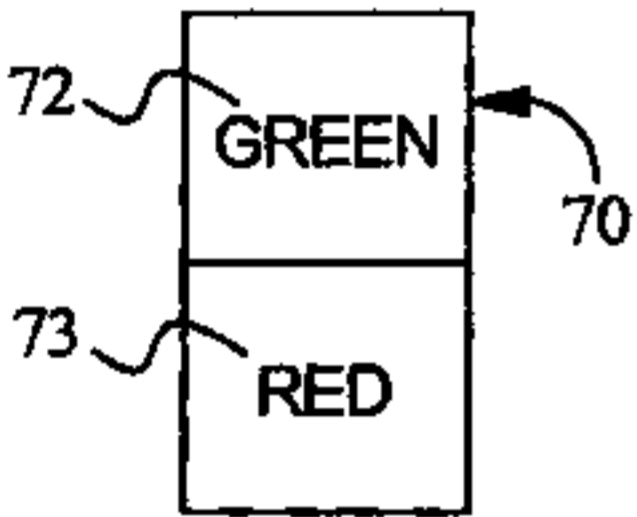

68

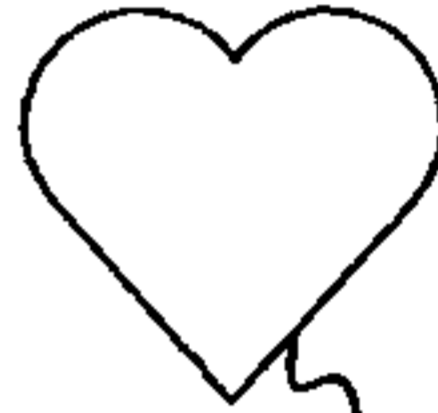

68



68

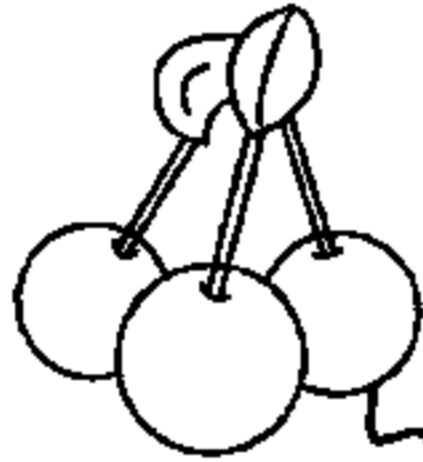

68



68

34a

34b

34c

TOTAL CREDITS



16