



(12) **United States Design Patent**
Mattoni

(10) **Patent No.:** **US D782,014 S**
(45) **Date of Patent:** **** Mar. 21, 2017**

- (54) **ARTICLE OF FURNITURE**
- (71) Applicant: **LABORATORIO MATTONI S.r.l.**,
Rome (IT)
- (72) Inventor: **Luca Mattoni**, Rome (IT)
- (73) Assignee: **Laboratorio Mattoni S.R.L.**, Rome
(IT)
- (**) Term: **15 Years**
- (21) Appl. No.: **29/551,789**
- (22) Filed: **Jan. 15, 2016**
- (51) **LOC (10) Cl.** **23-02**
- (52) **U.S. Cl.**
USPC **D23/272; D23/286**
- (58) **Field of Classification Search**
USPC D23/270-273, 284, 286-287, 285, 303,
D23/308; D6/655, 655.1, 656, 663, 671,
(Continued)

- (56) **References Cited**
U.S. PATENT DOCUMENTS

D144,033 S * 3/1946 Broadbent D23/286
D235,645 S * 7/1975 Peters, Jr. et al. D23/272
(Continued)

Primary Examiner — Robert Delehanty
(74) *Attorney, Agent, or Firm* — Arent Fox LLP

(57) **CLAIM**
The ornamental design for the article of furniture, as shown and described.

DESCRIPTION

FIG. 1 is a back perspective view of a first embodiment of an article of furniture showing my new design in a closed state;
FIG. 2 is a front perspective view of the article of furniture of FIG. 1 in an open state;

FIG. 3 is a front view of the article of furniture of FIG. 1 in a closed state;
FIG. 4 is a back view of the article of furniture of FIG. 1 in a closed state;
FIG. 5 is a left side view of the article of furniture of FIG. 1 in a closed state;
FIG. 6 is a right side view of the article of furniture of FIG. 1 in a closed state;
FIG. 7 is a top view of the article of furniture of FIG. 1 in a closed state;
FIG. 8 is a bottom view of the article of furniture of FIG. 1 in a closed state;
FIG. 9 is a front view of the article of furniture of FIG. 1 in an open state;
FIG. 10 is a back view of the article of furniture of FIG. 1 in an open state;
FIG. 11 is a left side view of the article of furniture of FIG. 1 in an open state;
FIG. 12 is a right side view of the article of furniture of FIG. 1 in an open state;
FIG. 13 is a top view of the article of furniture of FIG. 1 in an open state;
FIG. 14 is a bottom view of the article of furniture of FIG. 1 in an open state;
FIG. 15 is a back perspective view of a second embodiment of an article of furniture showing my new design in a closed state;
FIG. 16 is a front perspective view of the article of furniture of FIG. 15 in an open state;
FIG. 17 is a front view of the article of furniture of FIG. 15 in a closed state;
FIG. 18 is a back view of the article of furniture of FIG. 15 in a closed state;
FIG. 19 is a left side view of the article of furniture of FIG. 15 in a closed state;
FIG. 20 is a right side view of the article of furniture of FIG. 15 in a closed state;
FIG. 21 is a top view of the article of furniture of FIG. 15 in a closed state;
FIG. 22 is a bottom view of the article of furniture of FIG. 15 in a closed state;
FIG. 23 is a front view of the article of furniture of FIG. 15 in an open state;

(Continued)

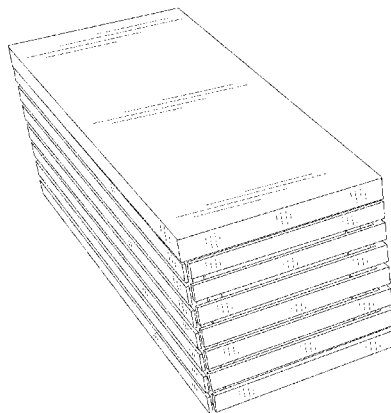

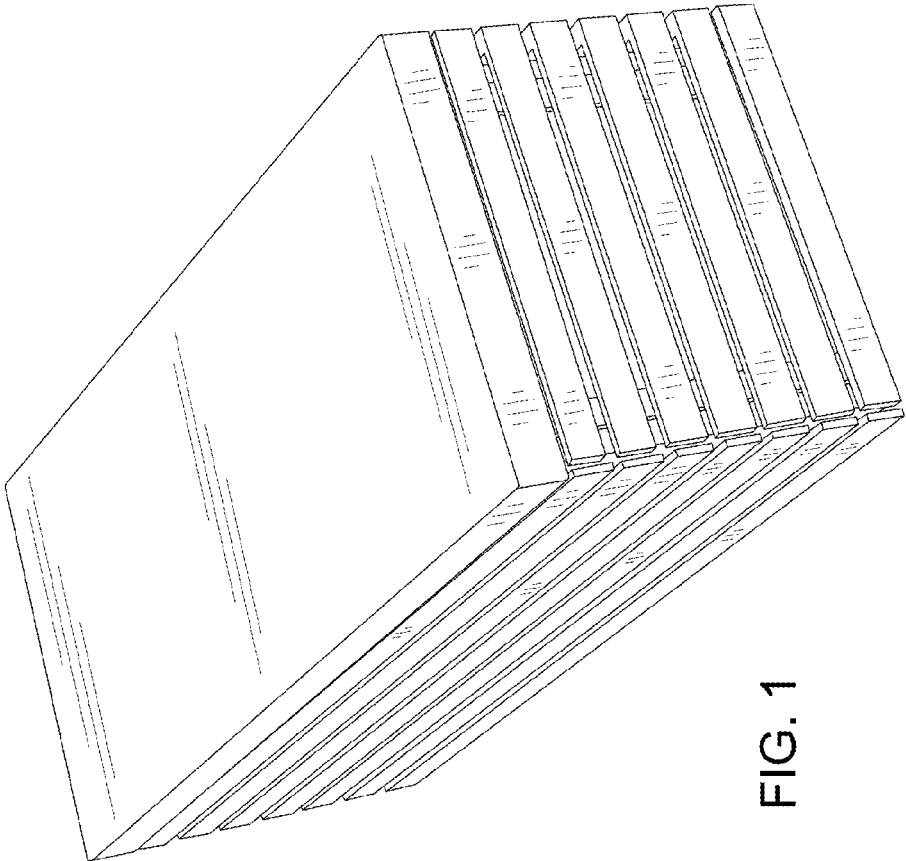

FIG. 1

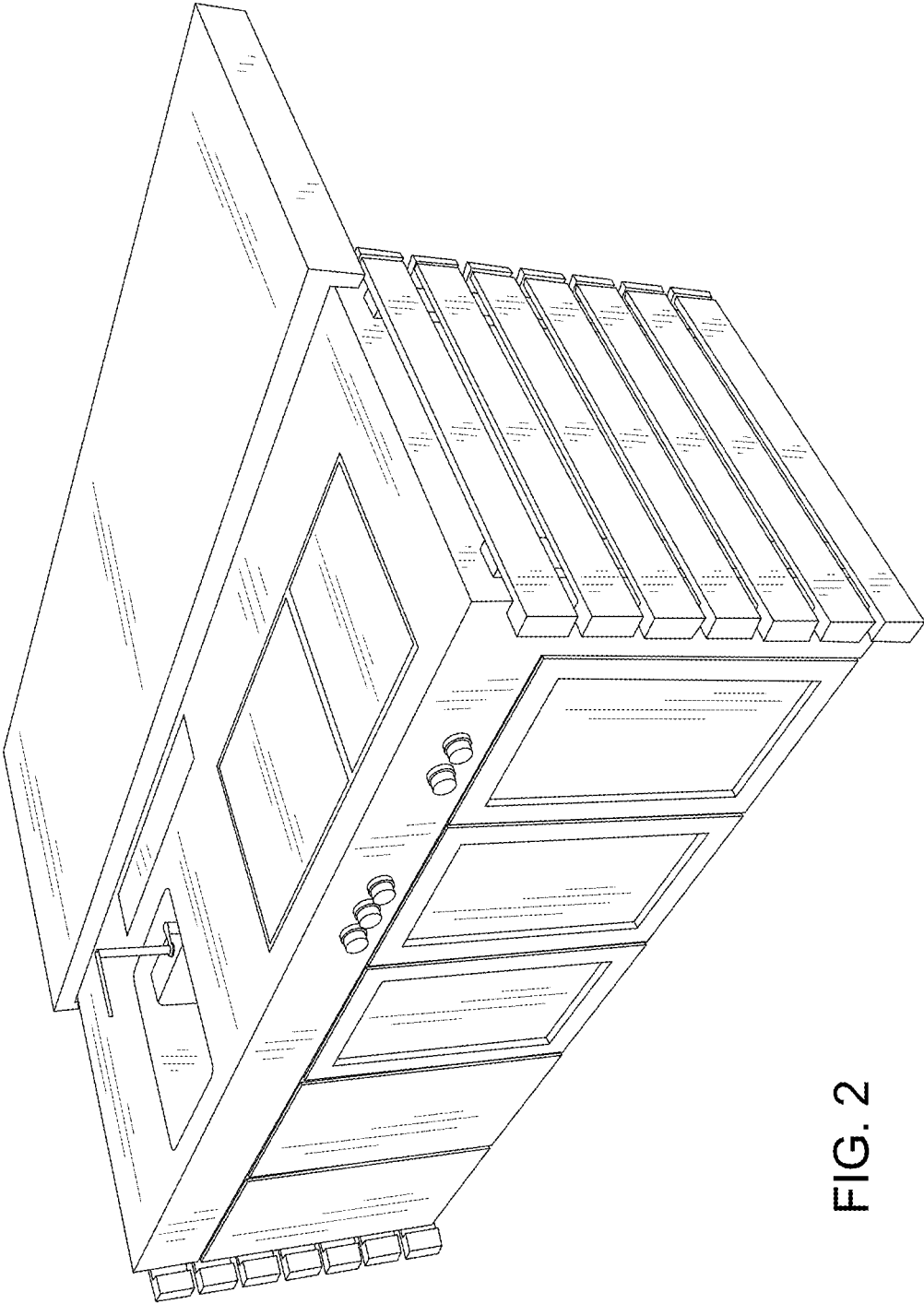

FIG. 2

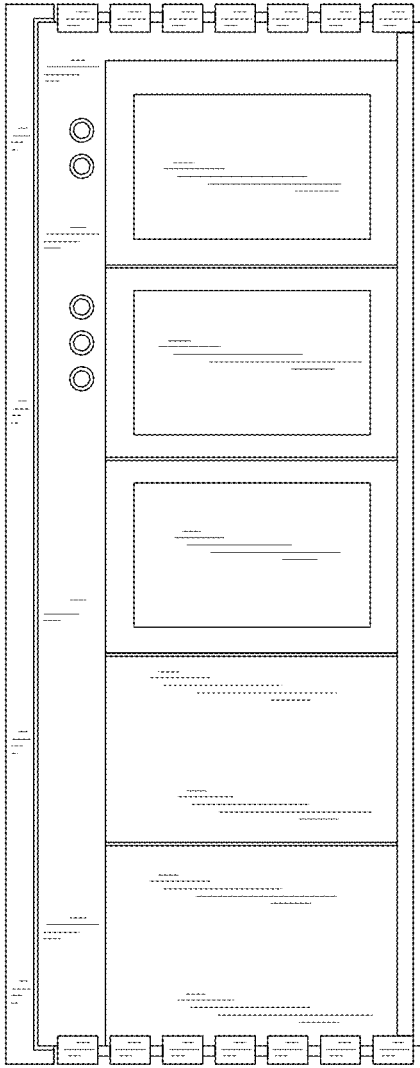

FIG. 3

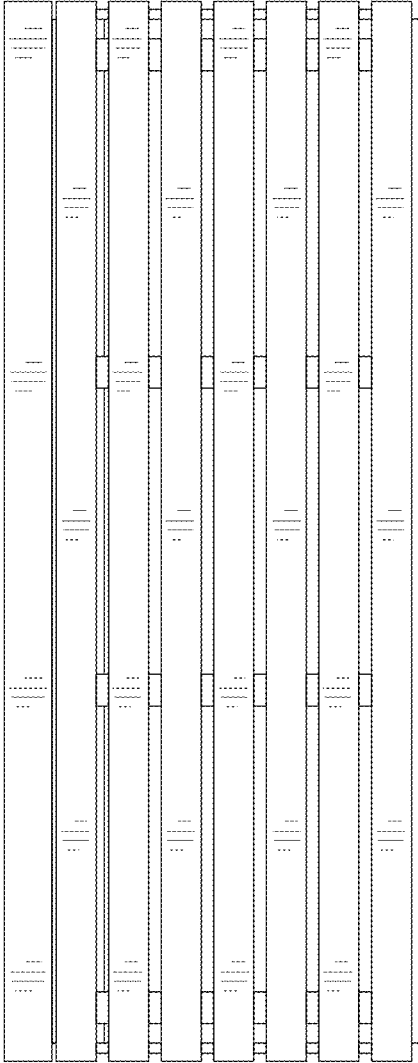

FIG. 4

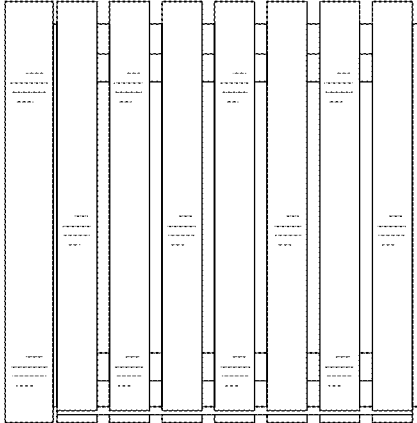

FIG. 5

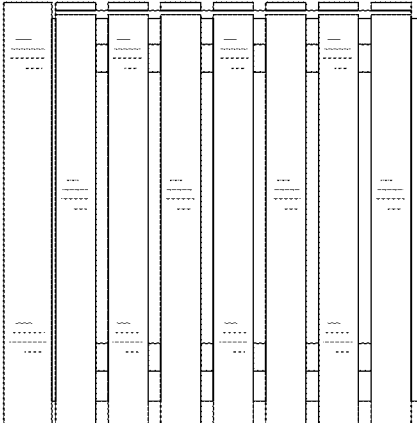

FIG. 6

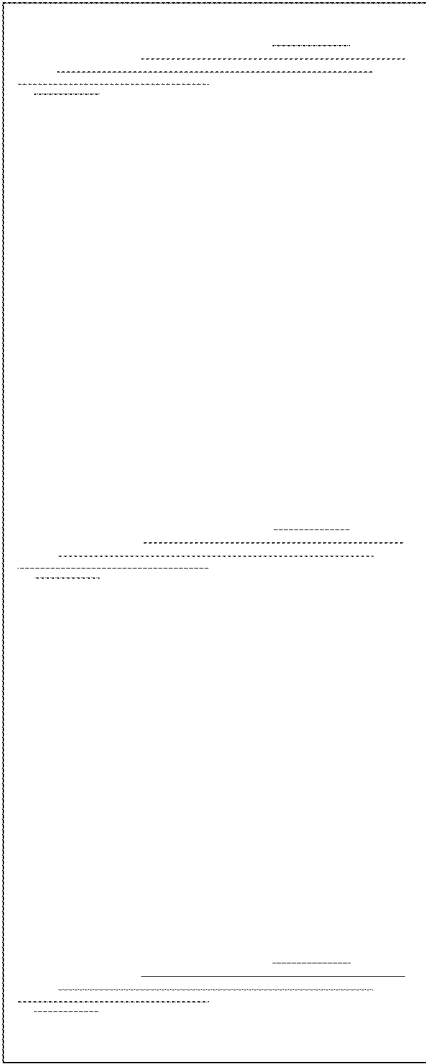

FIG. 7

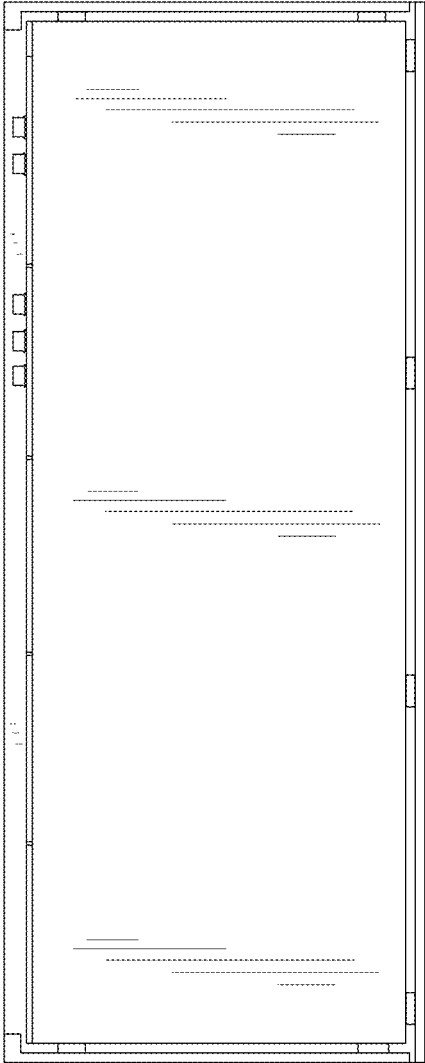

FIG. 8

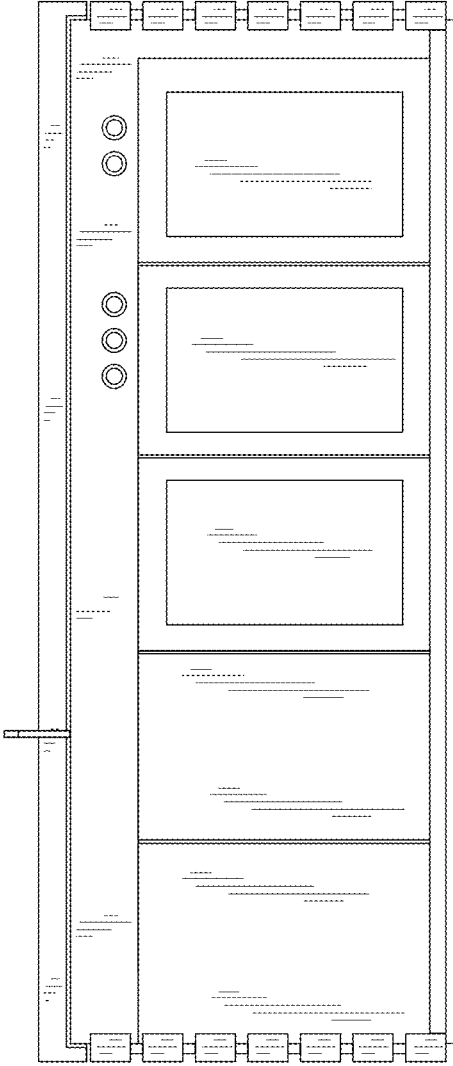

FIG. 9

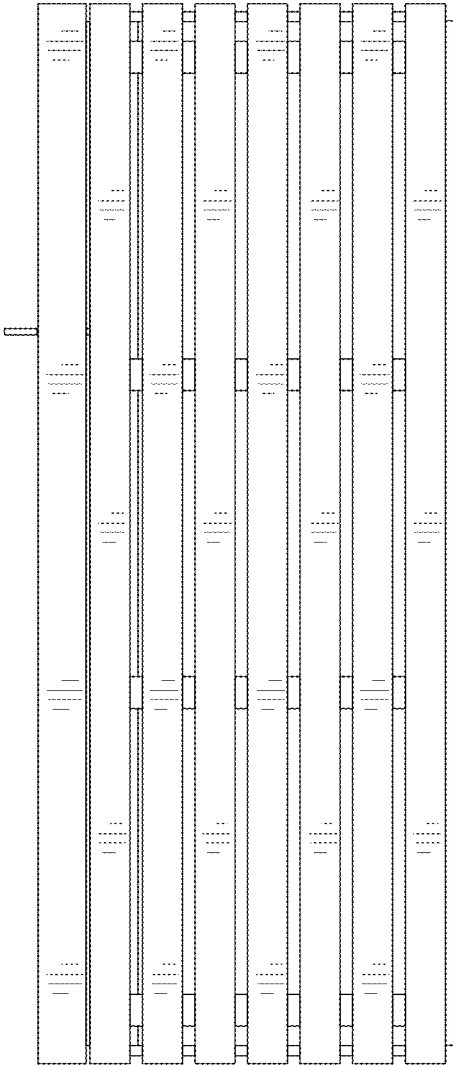

FIG. 10

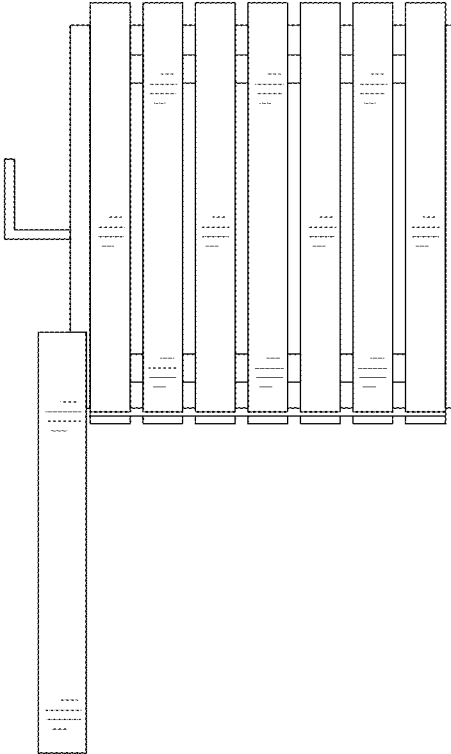

FIG. 11

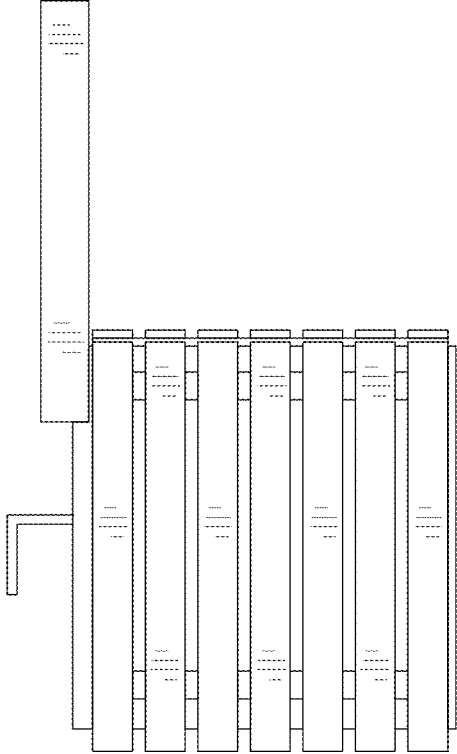

FIG. 12

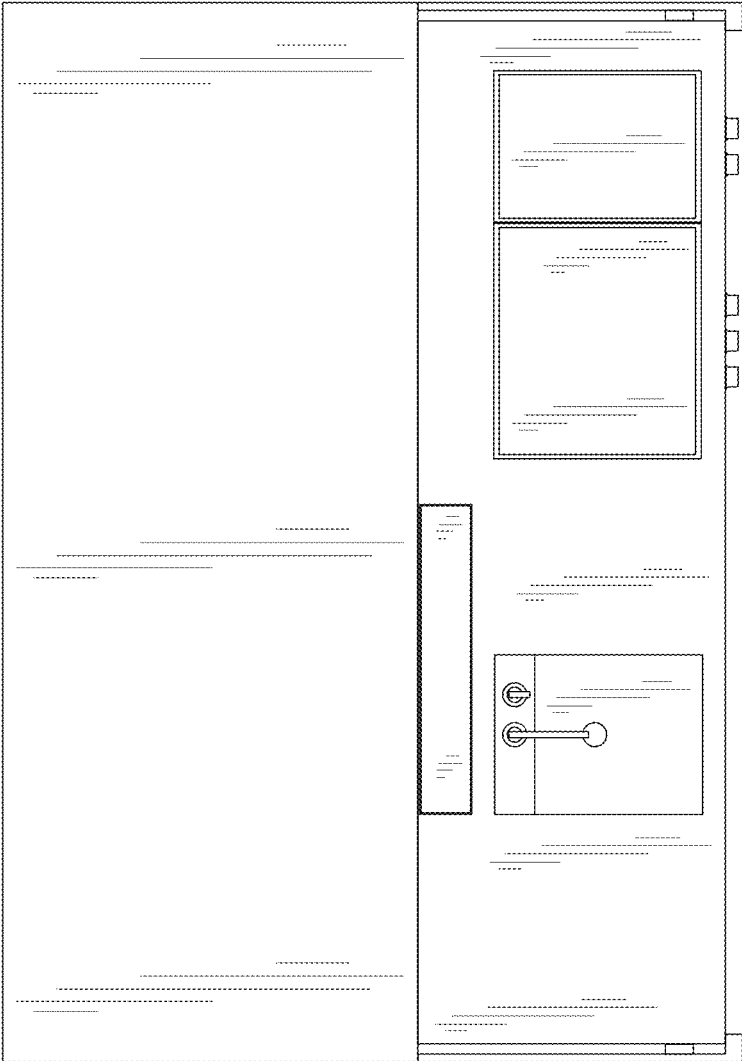

FIG. 13

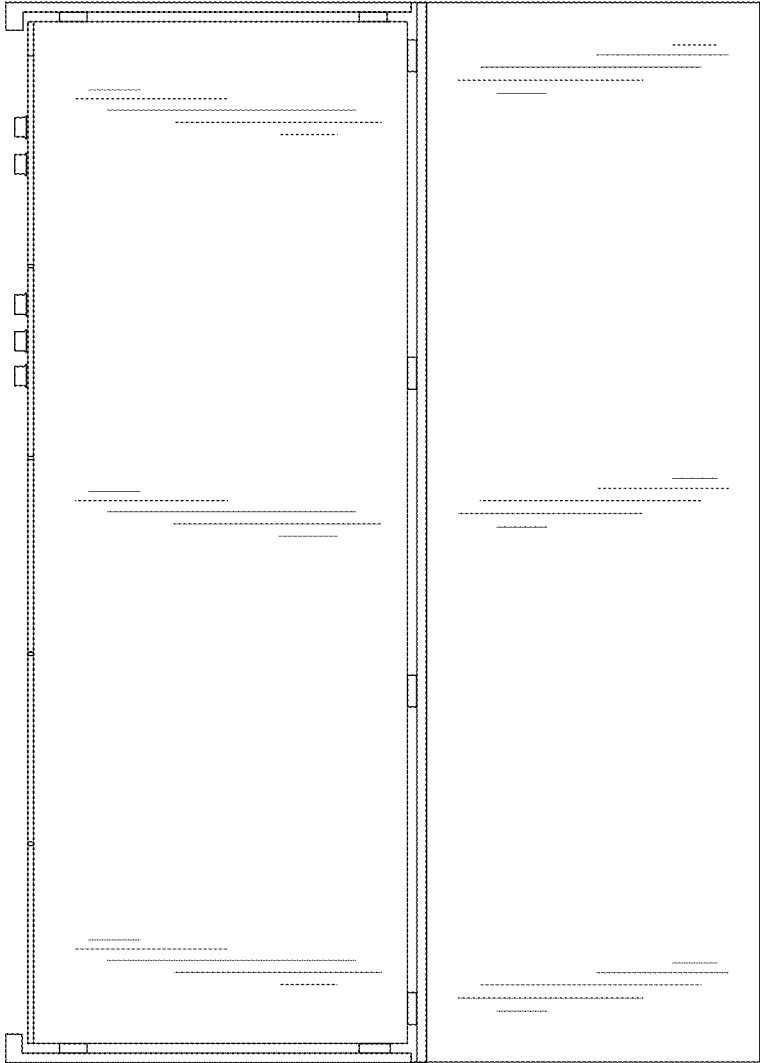

FIG. 14

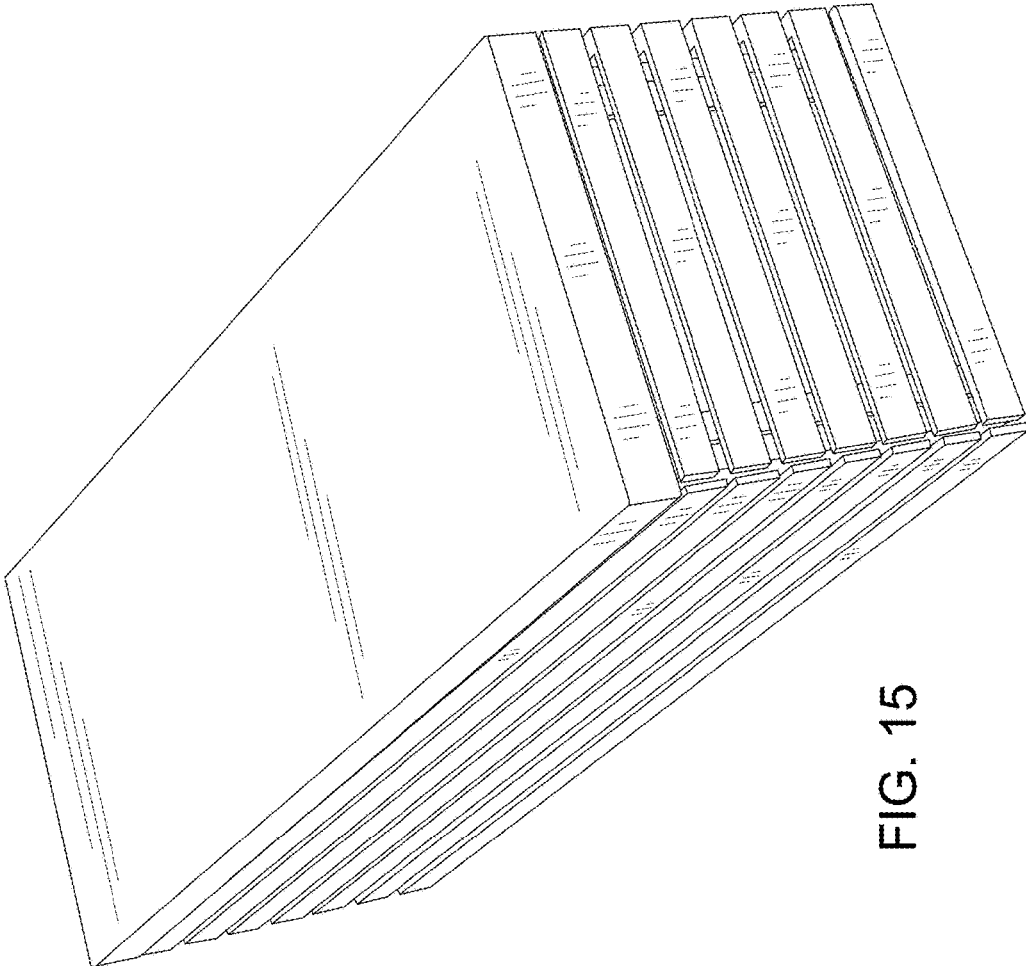

FIG. 15

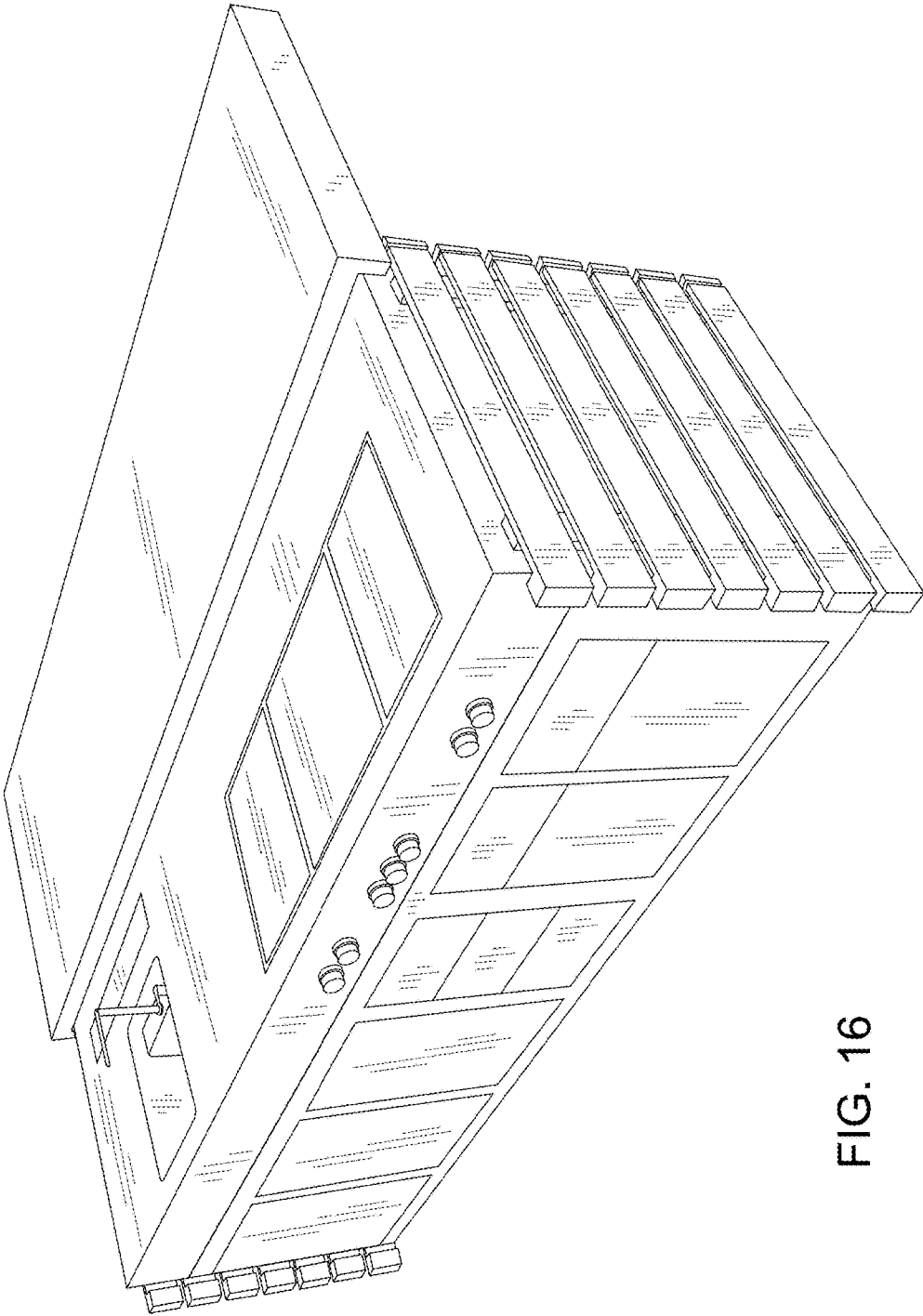

FIG. 16

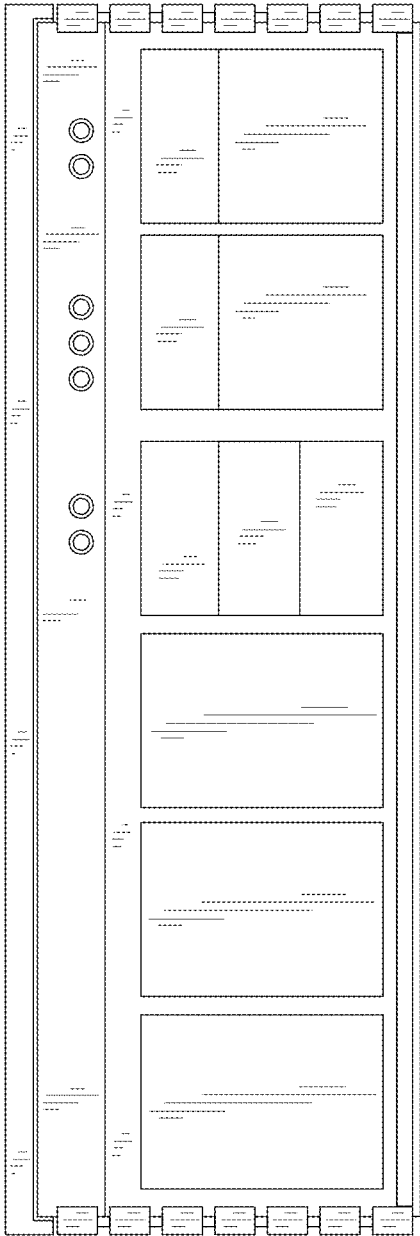

FIG. 17

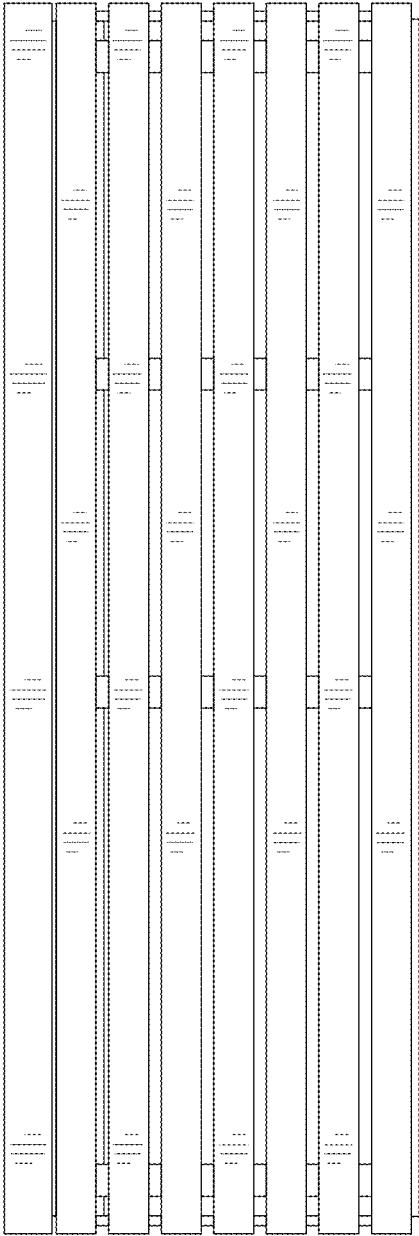

FIG. 18

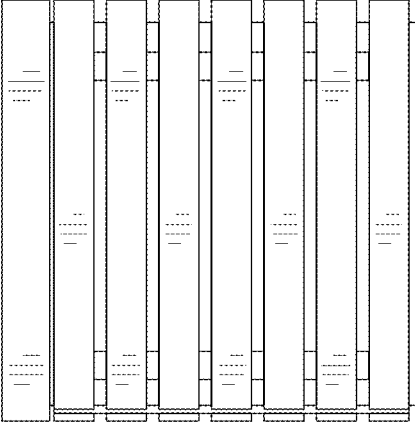

FIG. 19

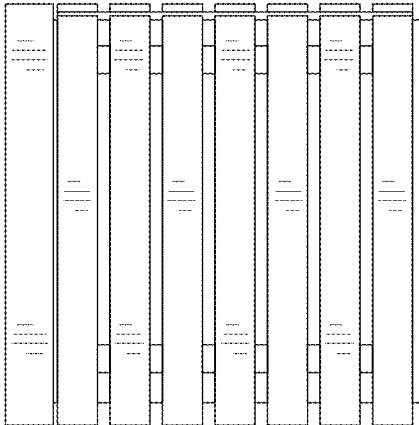

FIG. 20

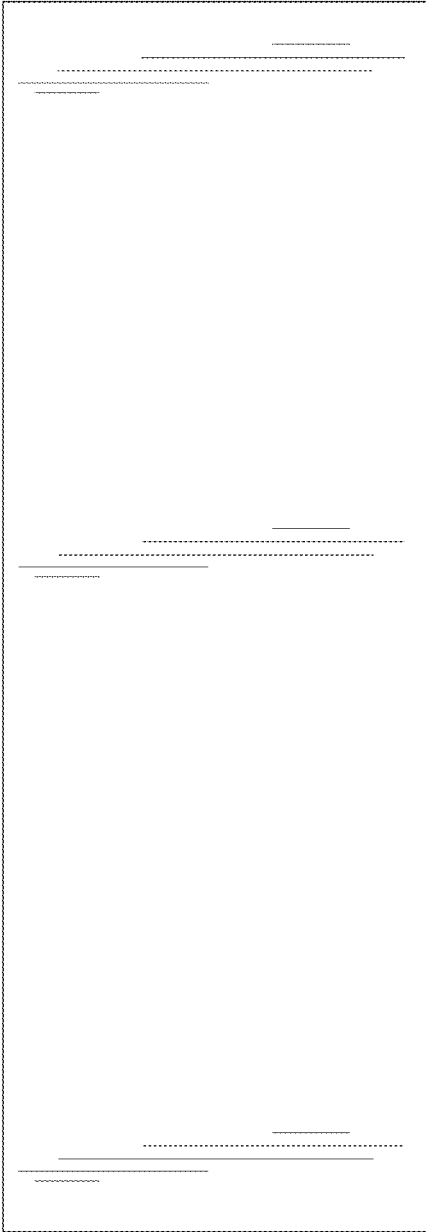

FIG. 21

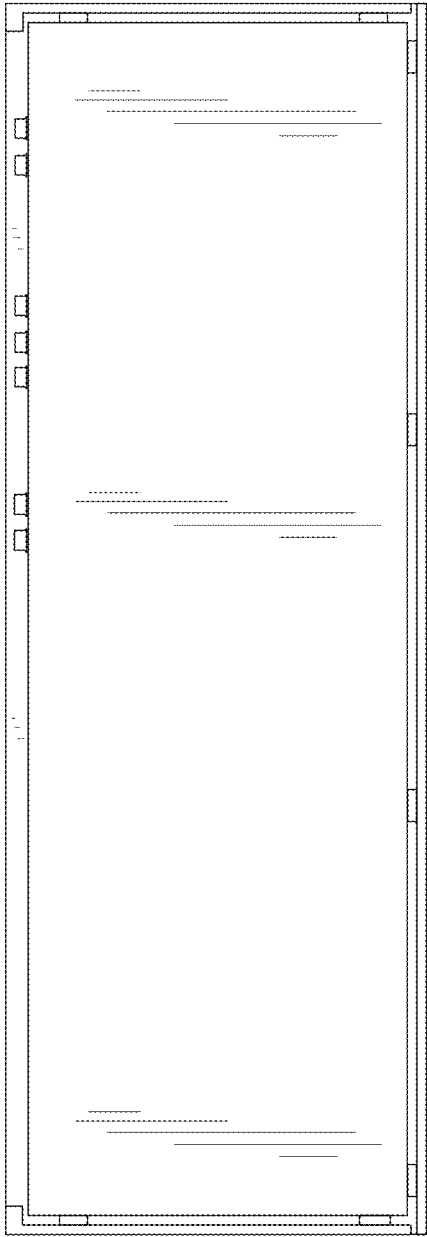

FIG. 22

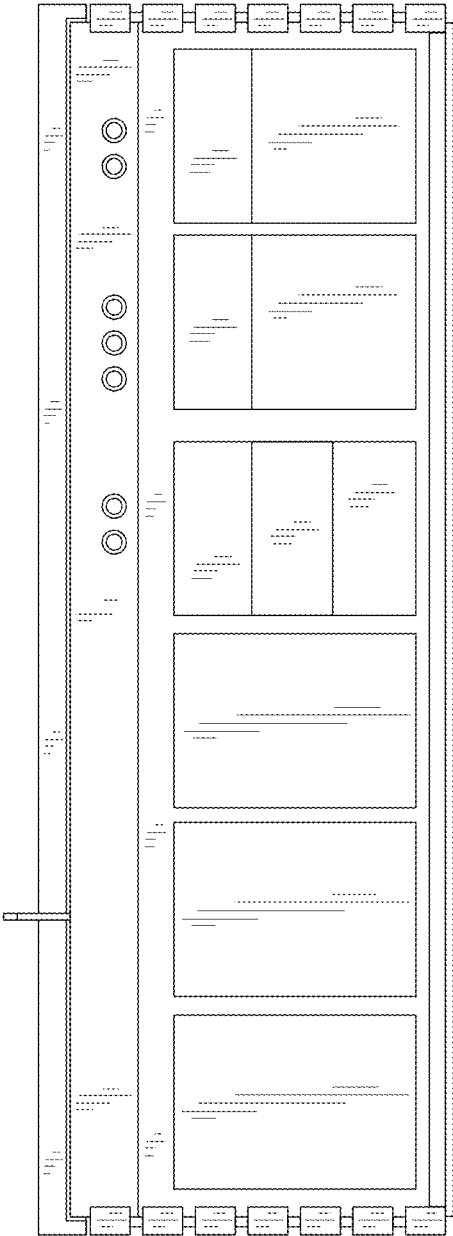

FIG. 23

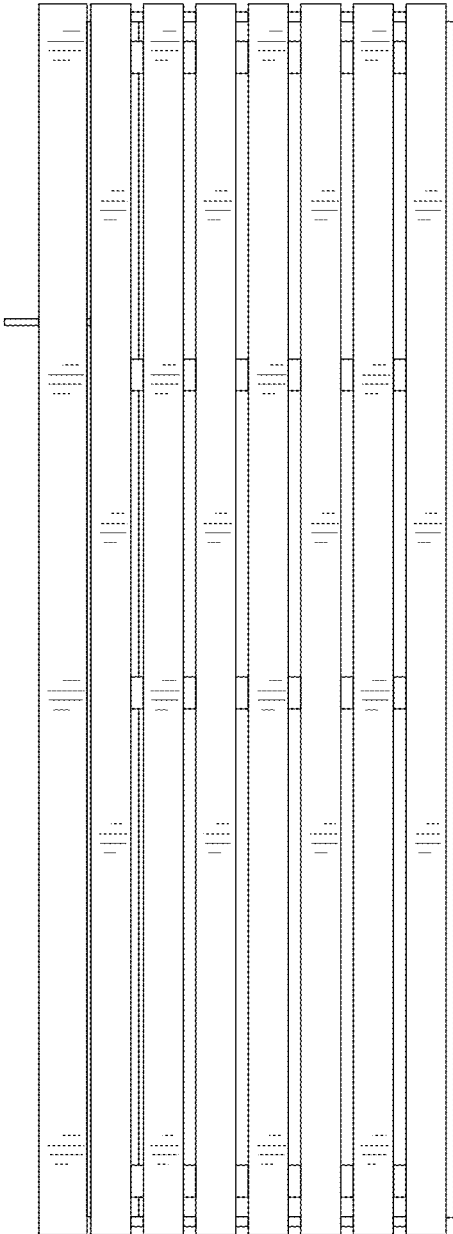

FIG. 24

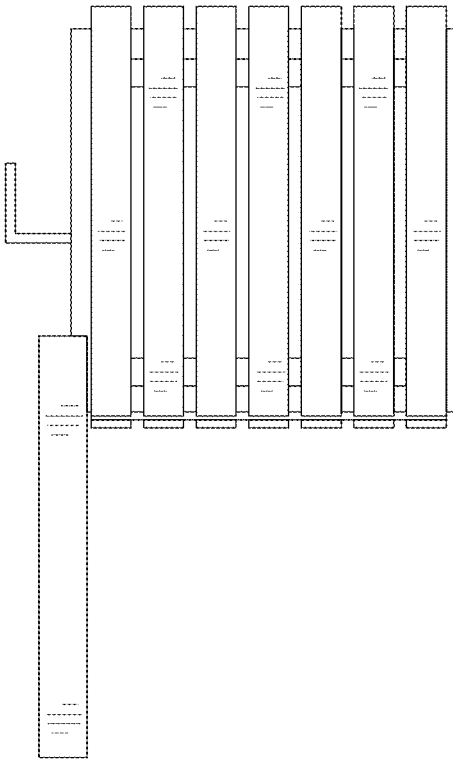

FIG. 25

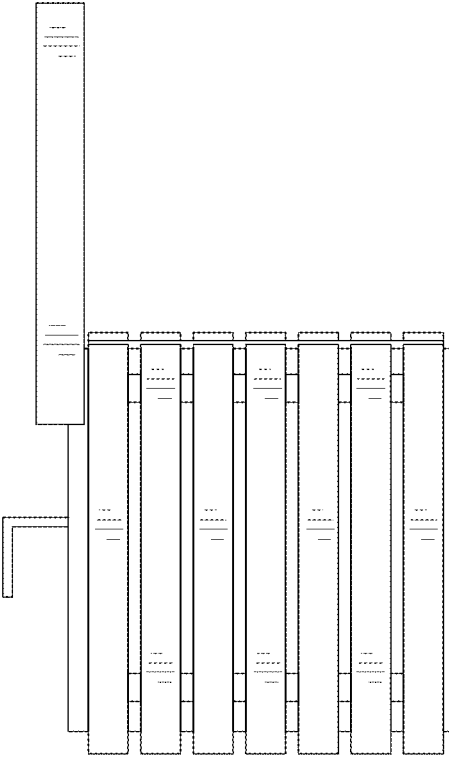

FIG. 26

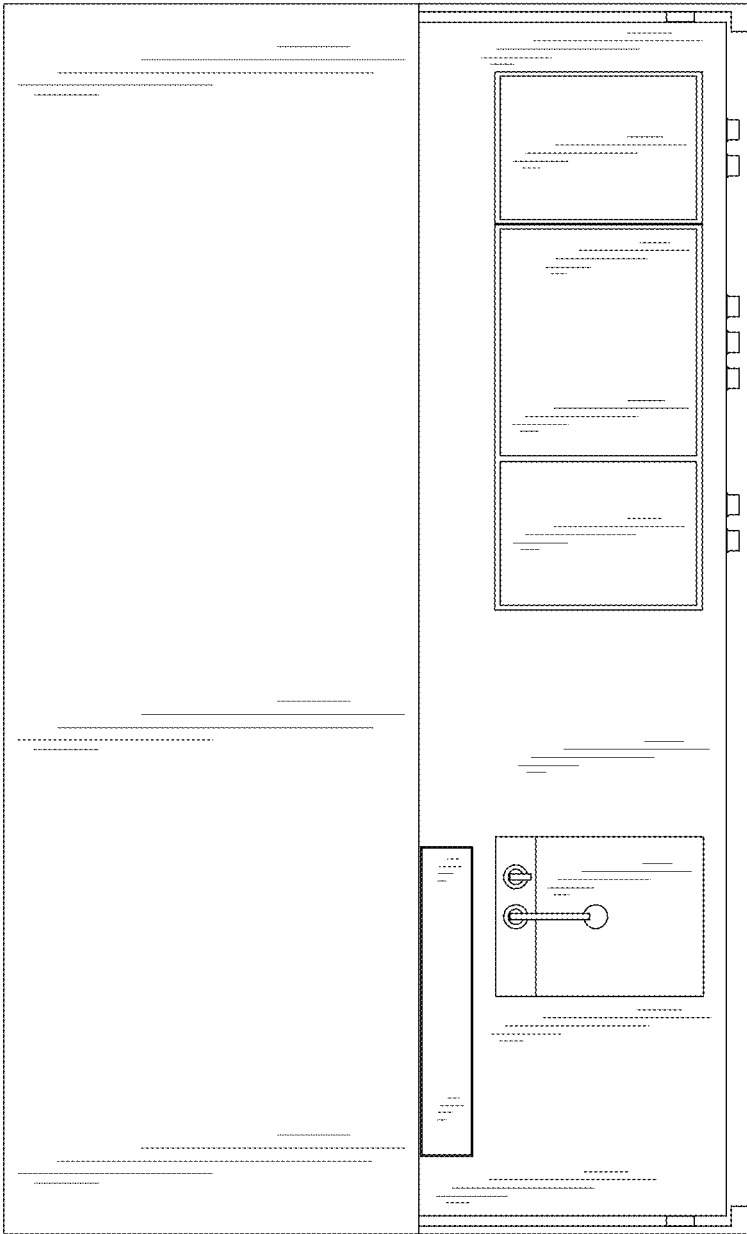

FIG. 27

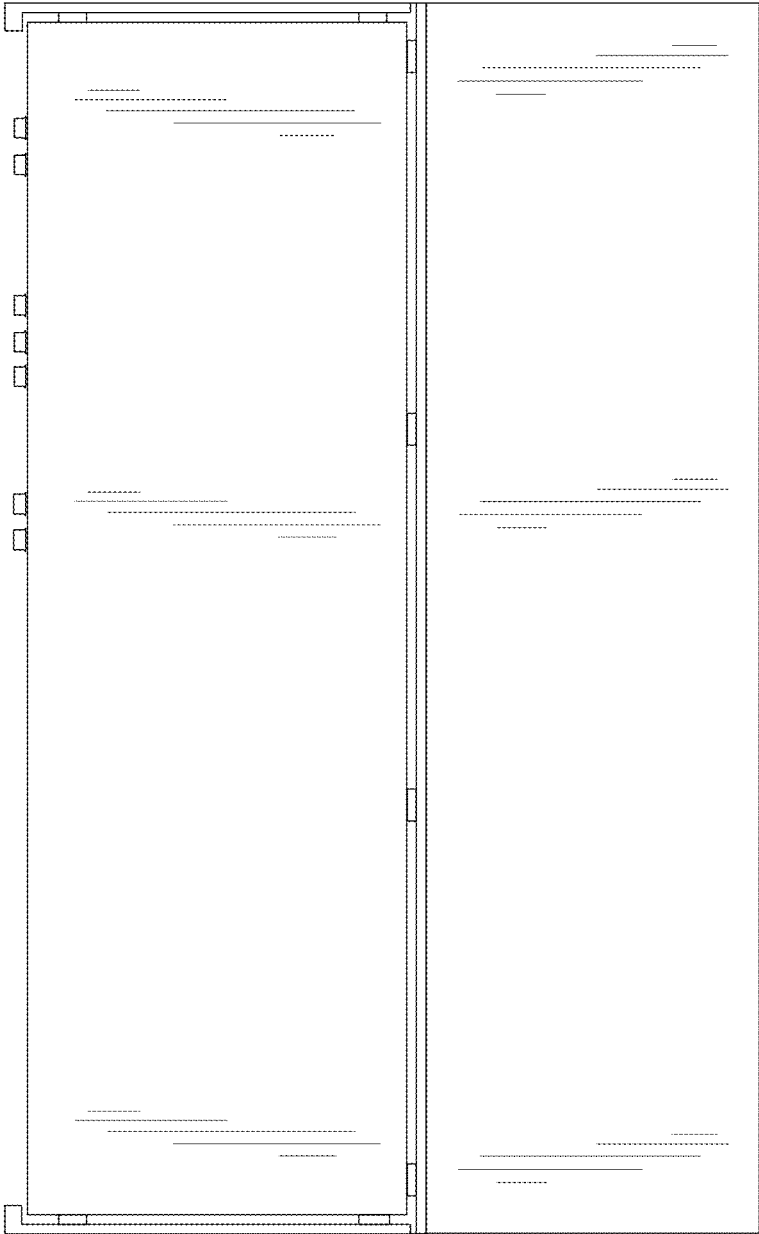

FIG. 28

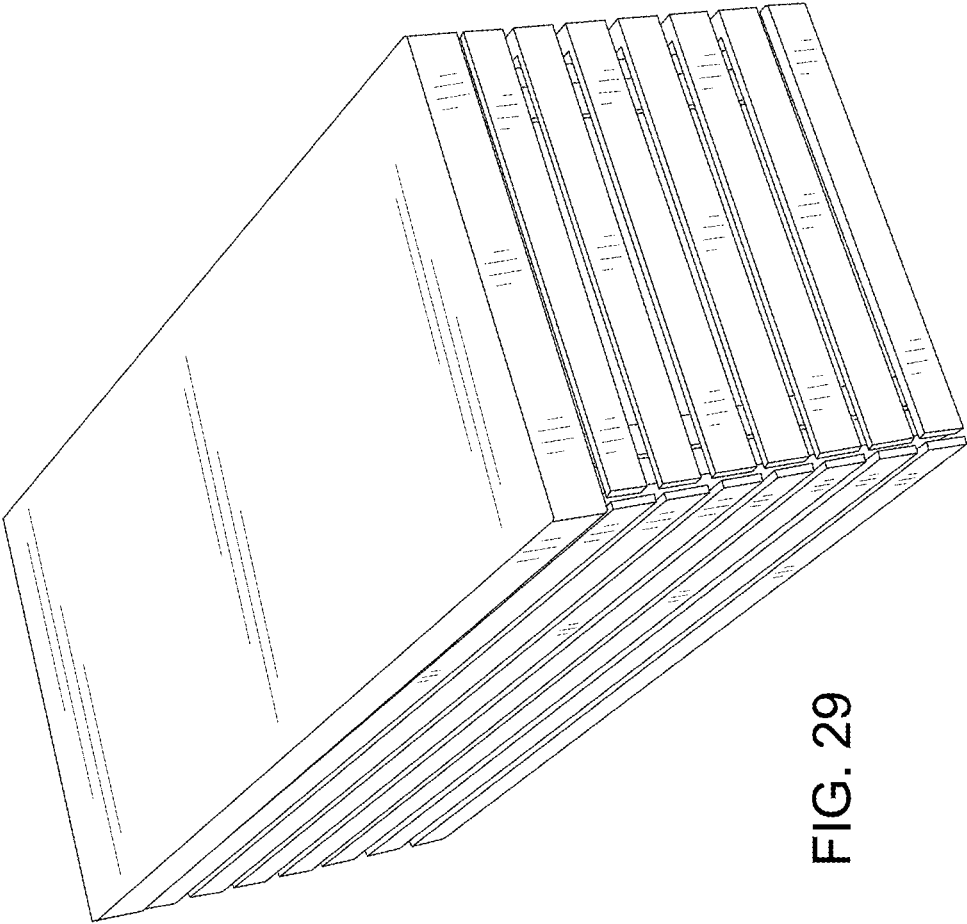

FIG. 29

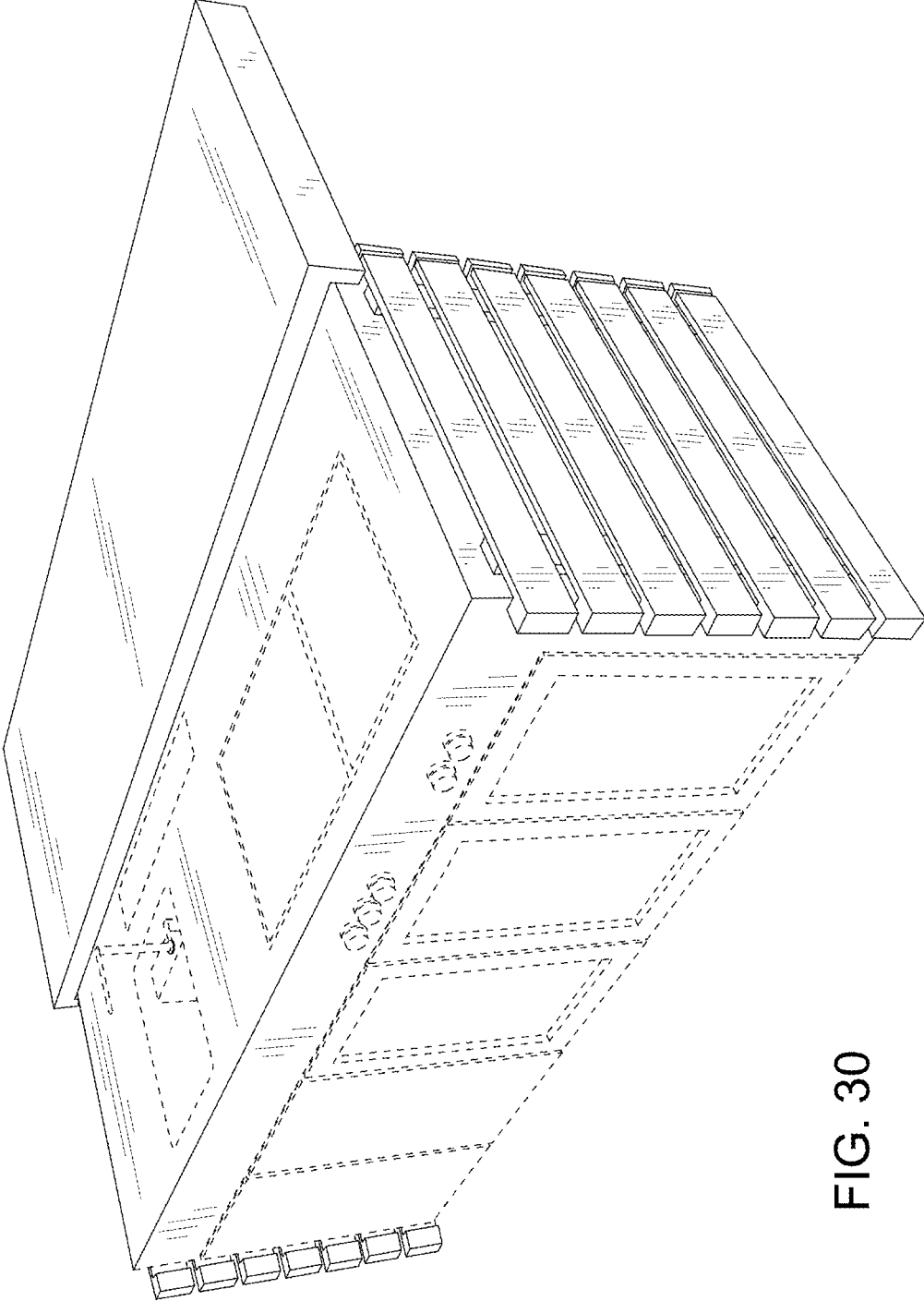

FIG. 30

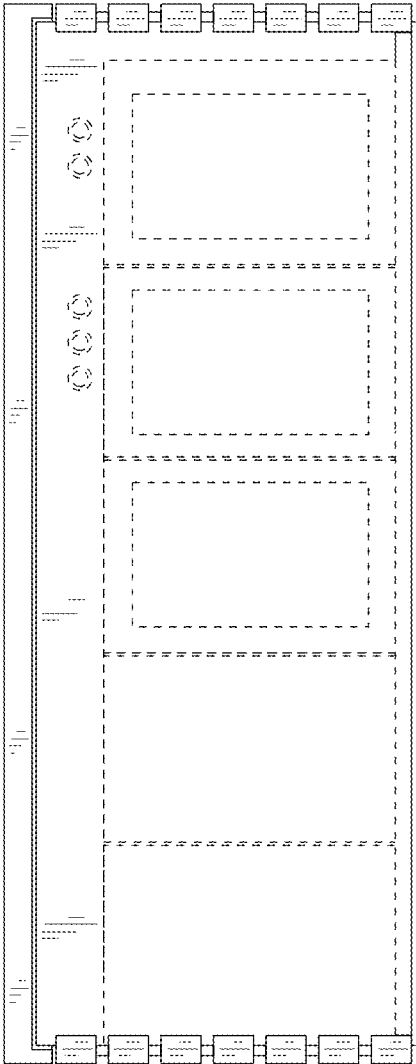

FIG. 31

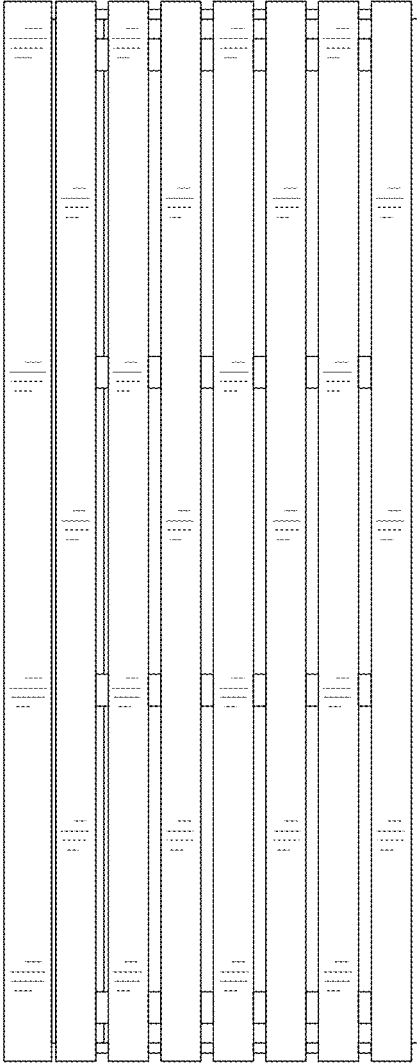

FIG. 32

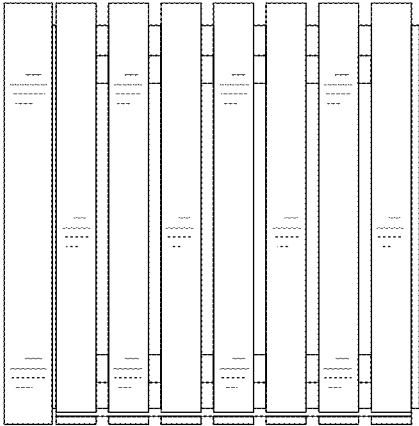

FIG. 33

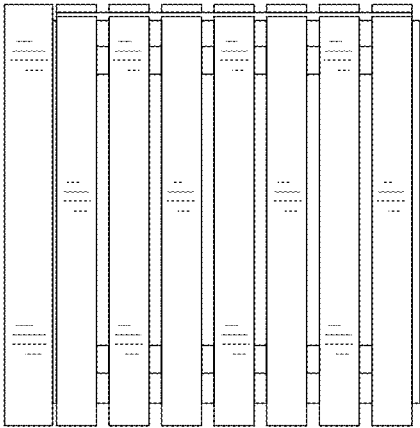

FIG. 34

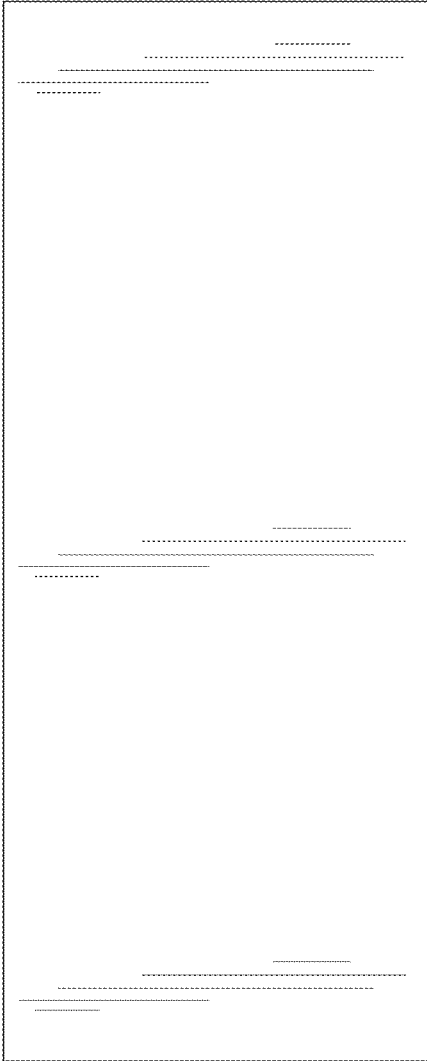

FIG. 35

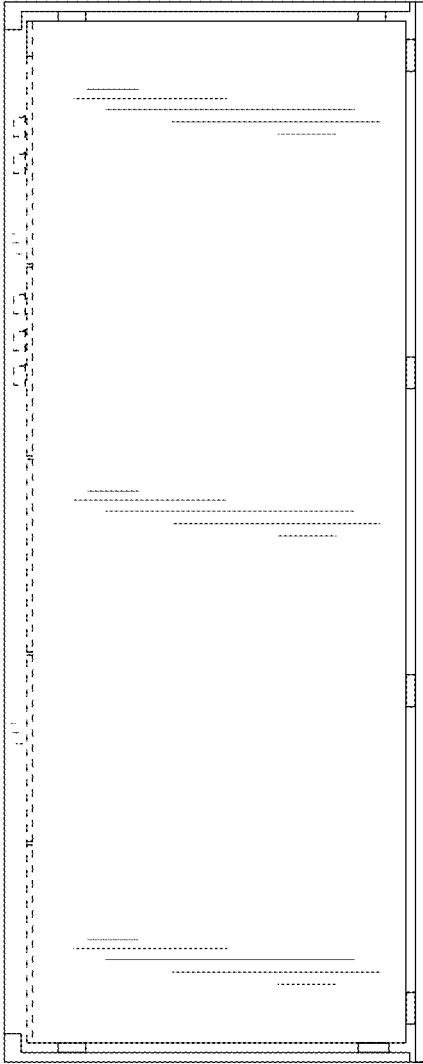

FIG. 36

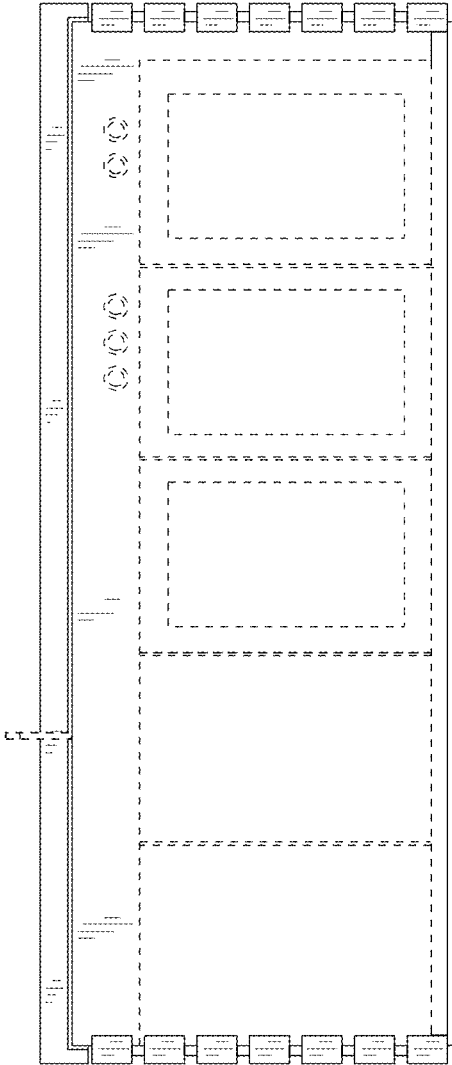

FIG. 37

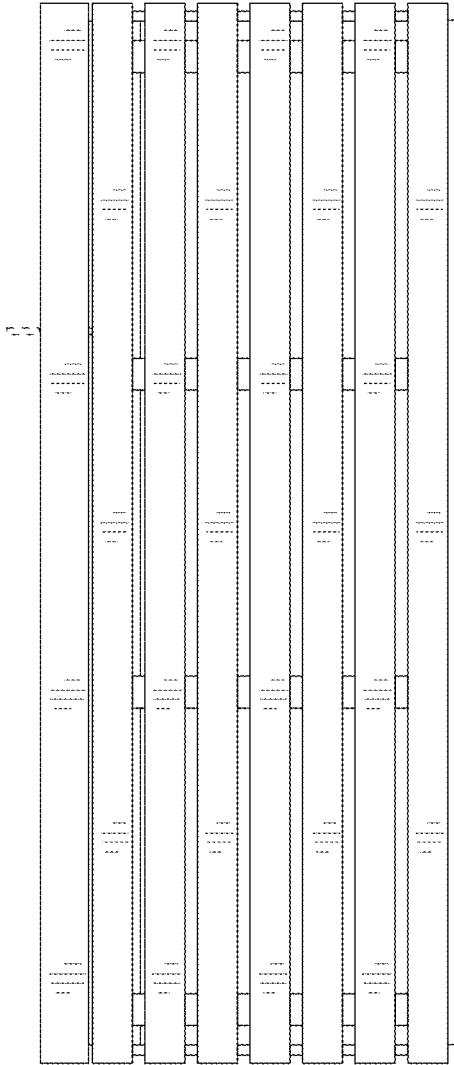

FIG. 38

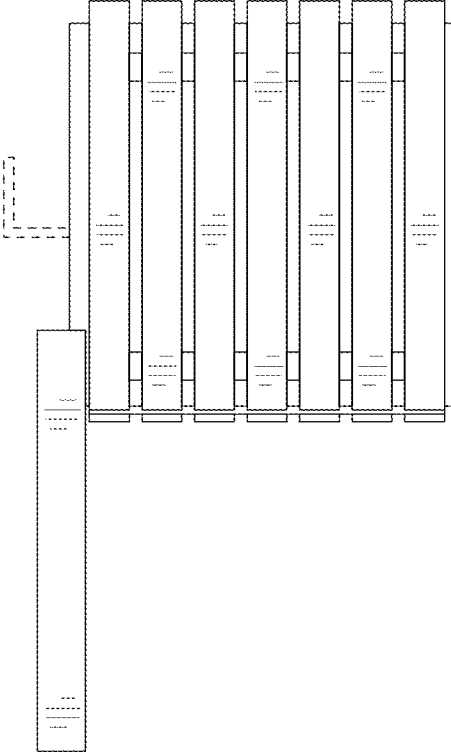

FIG. 39

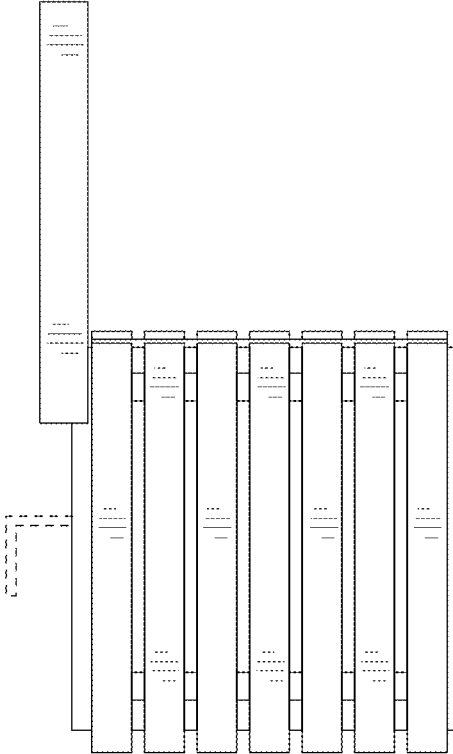

FIG. 40

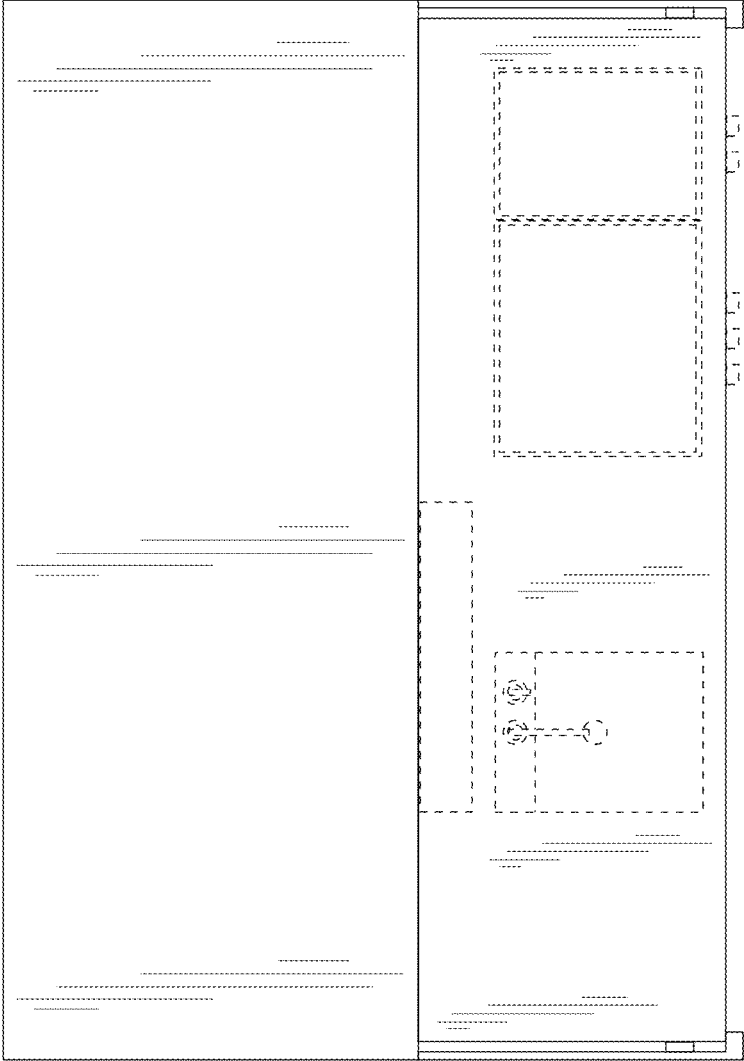

FIG. 41

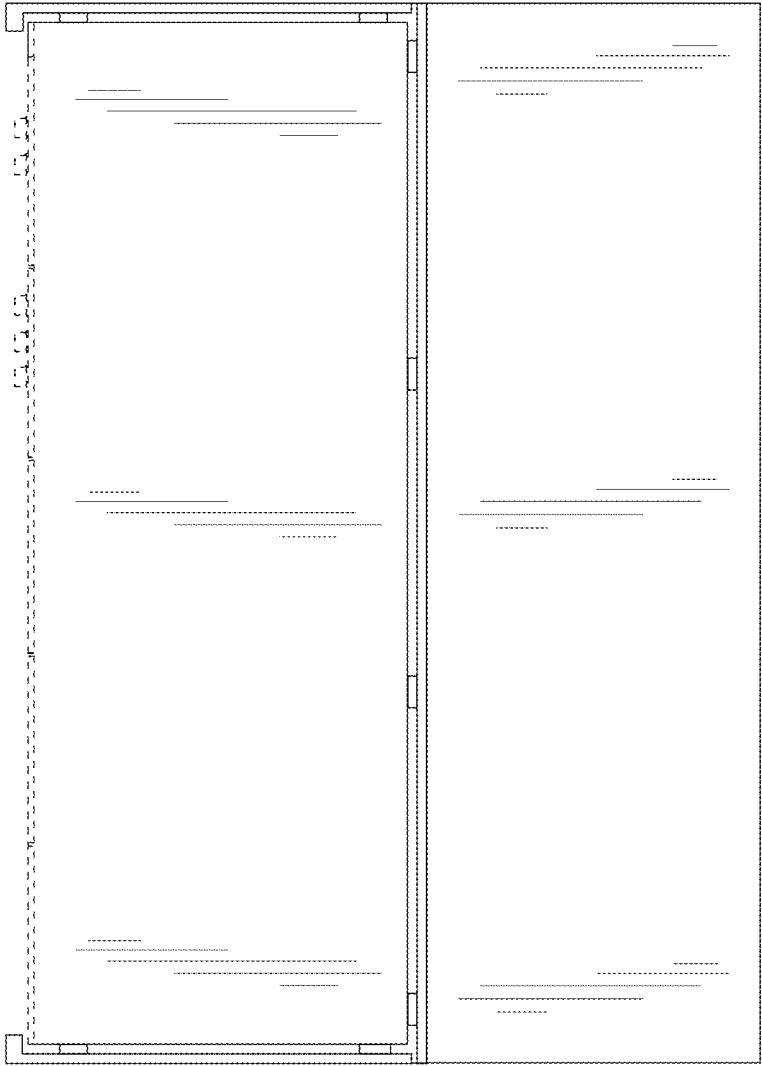

FIG. 42

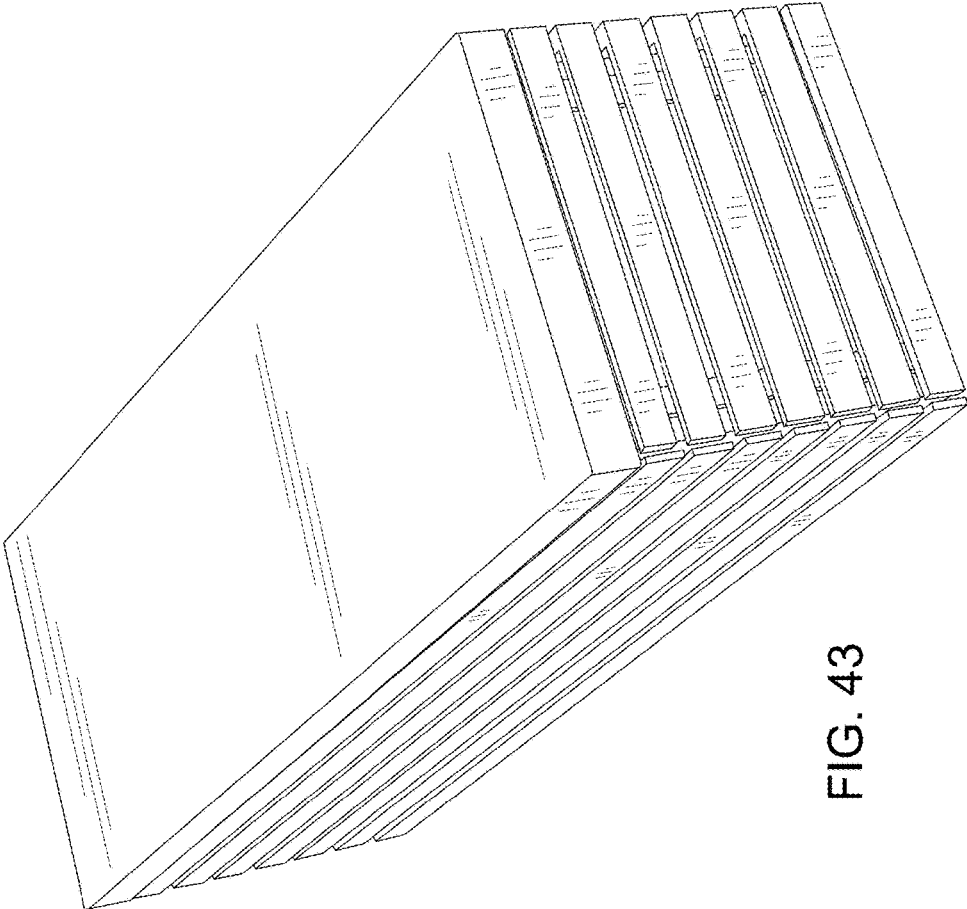

FIG. 43

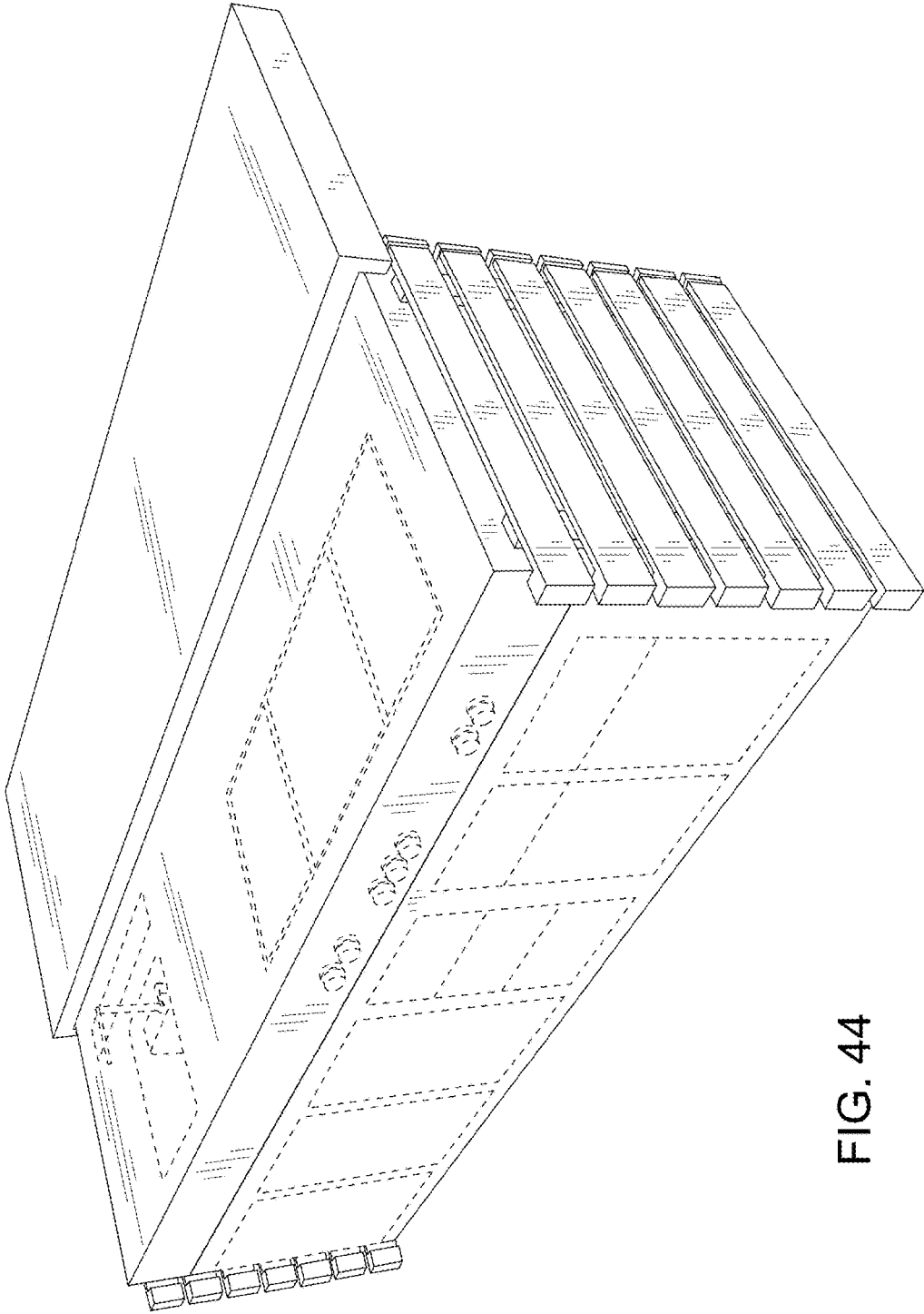

FIG. 44

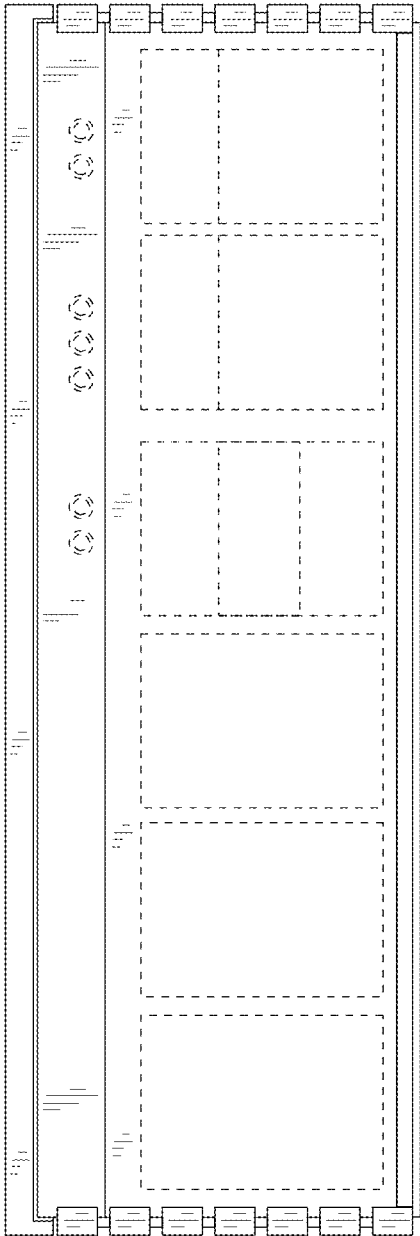

FIG. 45

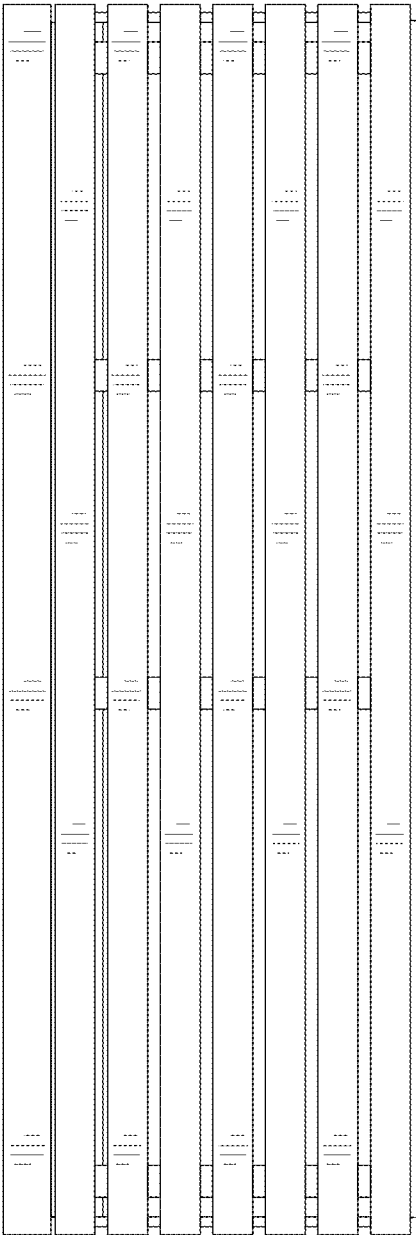

FIG. 46

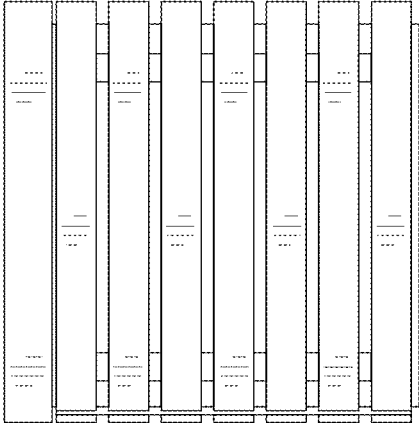

FIG. 47

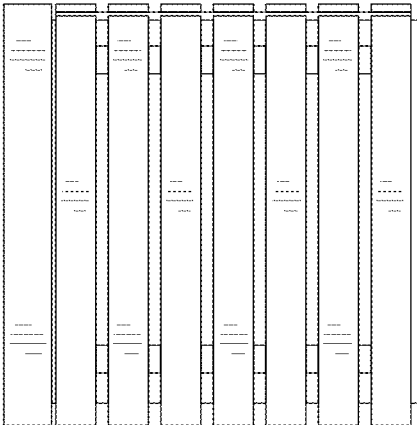

FIG. 48

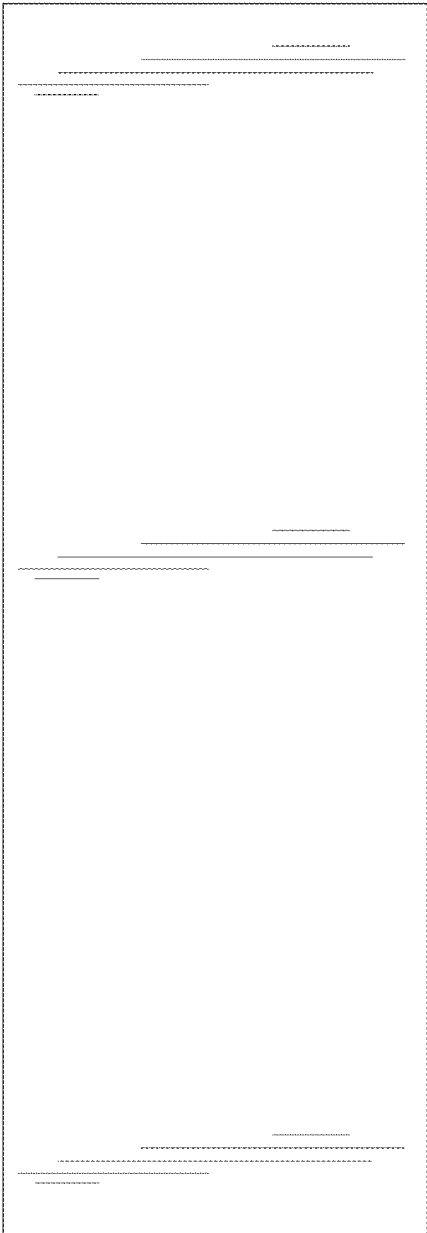

FIG. 49

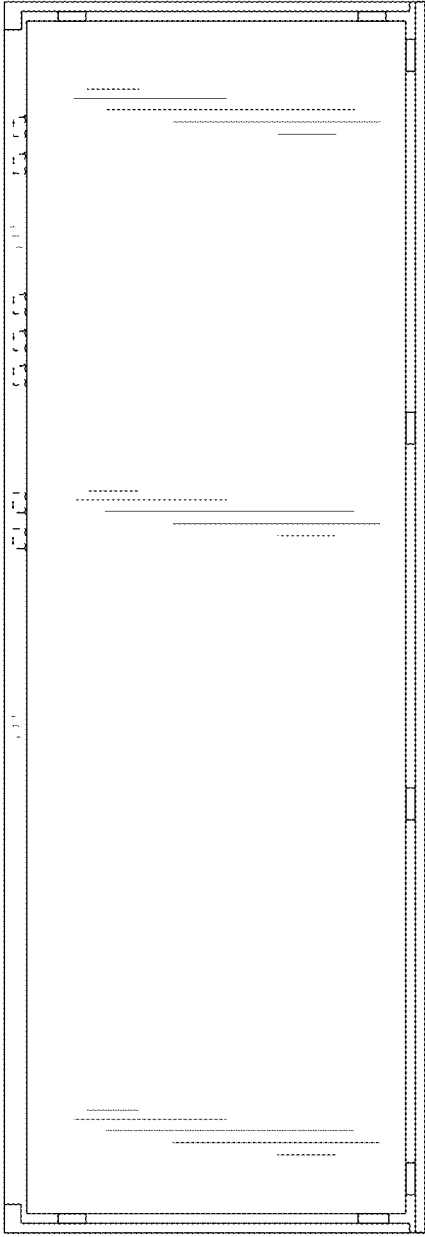

FIG. 50

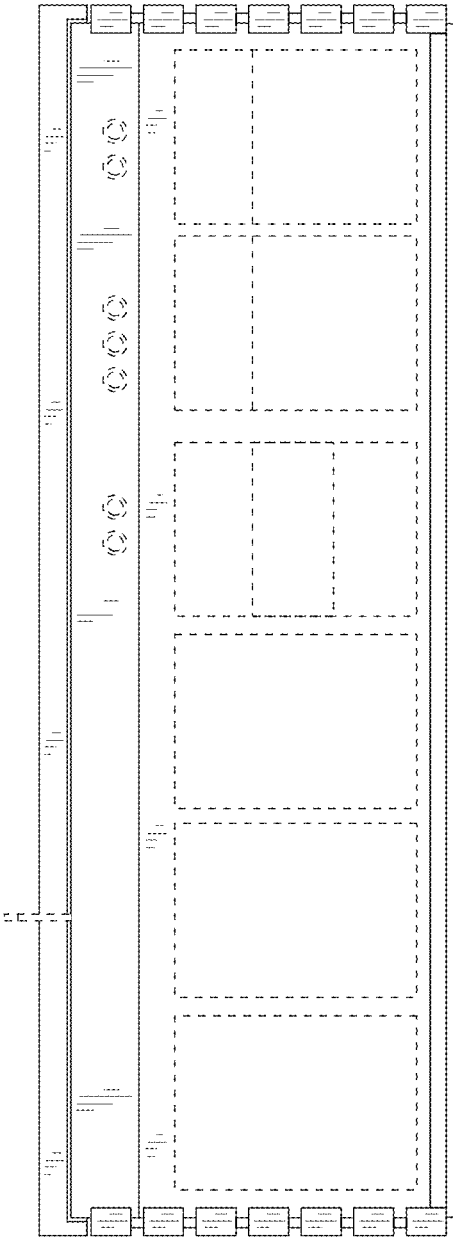

FIG. 51

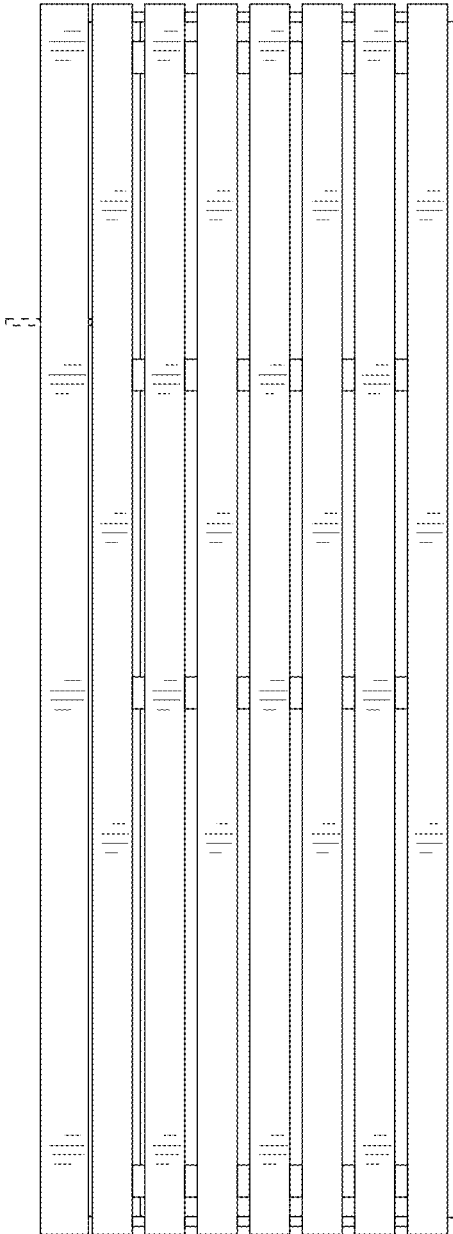

FIG. 52

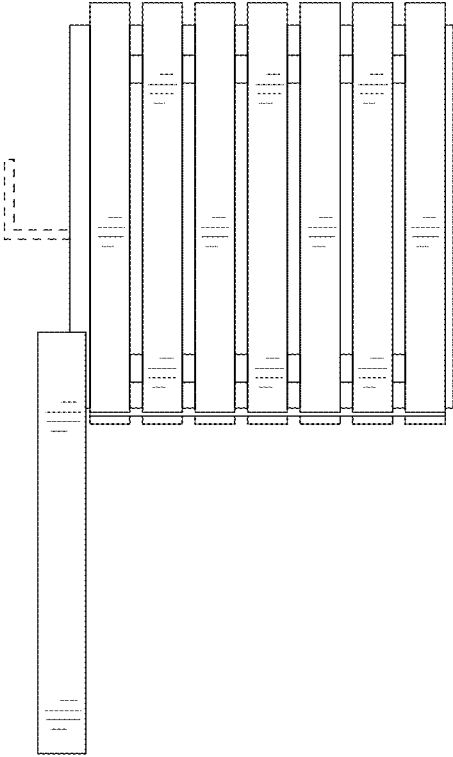

FIG. 53

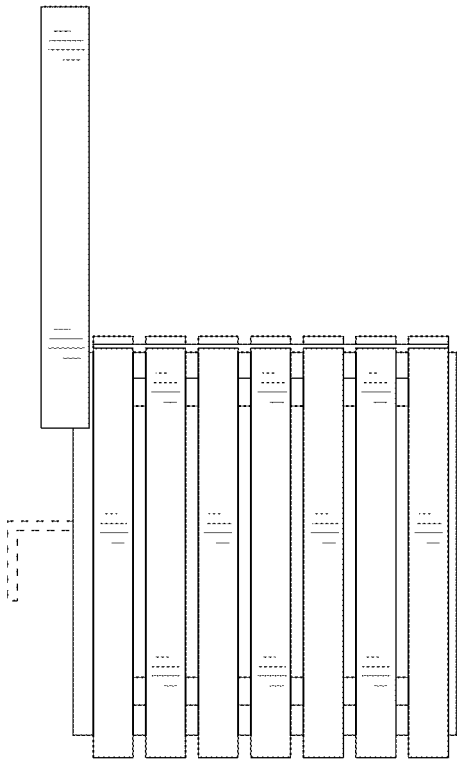

FIG. 54

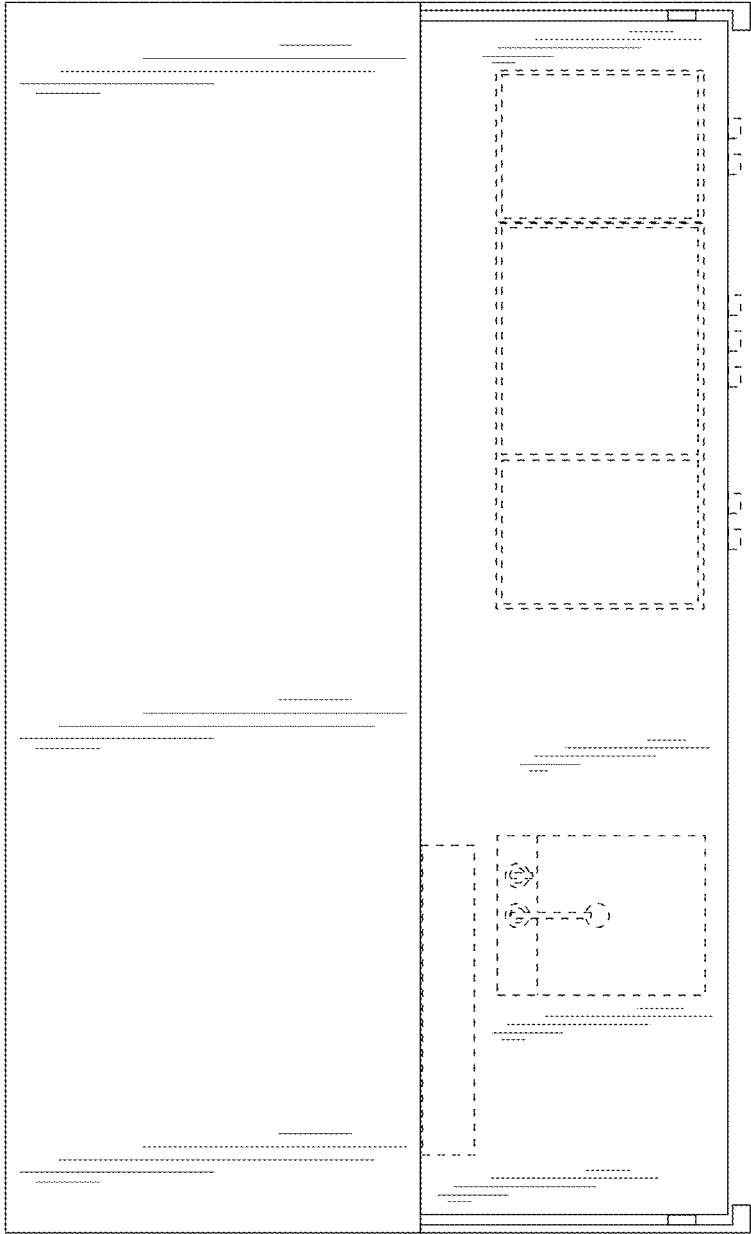

FIG. 55

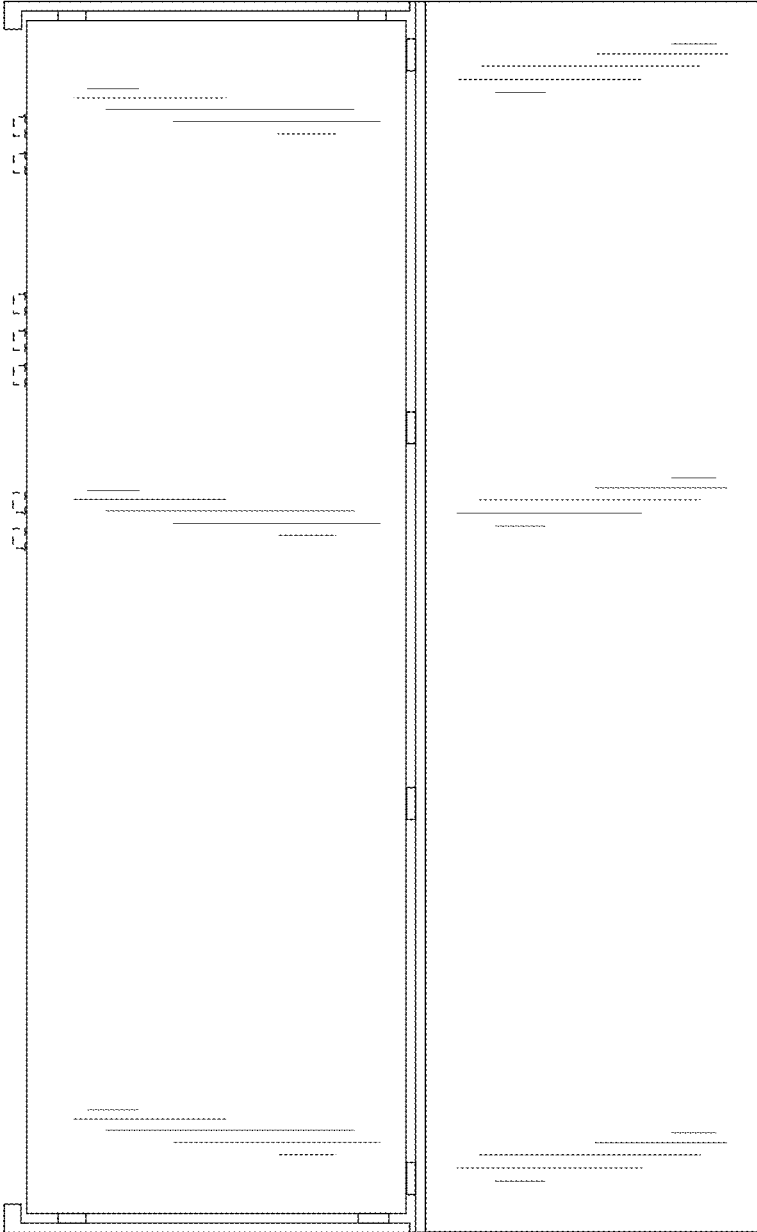

FIG. 56