



(12) **DEMANDE DE BREVET CANADIEN  
CANADIAN PATENT APPLICATION**

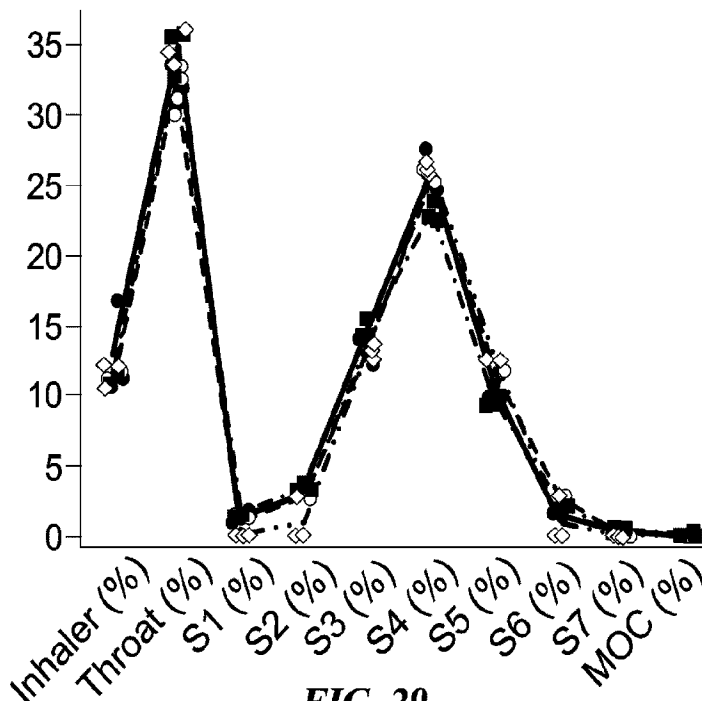
(13) **A1**

(86) Date de dépôt PCT/PCT Filing Date: 2022/07/08  
 (87) Date publication PCT/PCT Publication Date: 2023/01/12  
 (85) Entrée phase nationale/National Entry: 2024/01/04  
 (86) N° demande PCT/PCT Application No.: US 2022/036548  
 (87) N° publication PCT/PCT Publication No.: 2023/283441  
 (30) Priorités/Priorities: 2021/07/09 (US63/220,362);  
 2021/11/23 (US63/282,356)

(51) Cl.Int./Int.Cl. *A61K 9/00* (2006.01),  
*A61K 31/00* (2006.01)  
 (71) Demandeur/Applicant:  
 ASTRAZENECA PHARMACEUTICALS LP, US  
 (72) Inventeurs/Inventors:  
 JOSHI, VIDYA, US;  
 ARCHBELL, JAMES, US;  
 LACHACZ, KELLISA, US;  
 LAMPA, CHARINA, US;  
 MELLO, LAUREN, US;  
 GUTIERREZ, GERTRUDE, US;  
 LECHUGA-BALLESTEROS, DAVID, US;  
 ...  
 (74) Agent: SMART & BIGGAR LP

(54) Titre : COMPOSITIONS, METHODES ET SYSTEMES POUR L'ADMINISTRATION D'UN MEDICAMENT EN AEROSOL

(54) Title: COMPOSITIONS, METHODS AND SYSTEMS FOR AEROSOL DRUG DELIVERY



**FIG. 29**

(57) **Abrégé/Abstract:**

Compositions, methods, and systems are provided for pulmonary delivery of active agents via a metered dose inhaler. In some embodiments, the compositions comprise an HFO-1234ze(E) suspension medium, active agent particles, and suspending particles. The active agent particles may comprise one, two, three or four active agent(s) selected from a long-acting muscarinic antagonist (LAMA), a long-acting  $\beta$ 2-agonists (LABA), a short-acting beta-agonists (SABA), an inhaled corticosteroid (ICS), and a non-corticosteroid anti-inflammatory agent.

(72) Inventeurs(suite)/Inventors(continued): TAN, PENNY, US; RIEBE, MICHAEL, US

(12) INTERNATIONAL APPLICATION PUBLISHED UNDER THE PATENT COOPERATION TREATY (PCT)

(19) World Intellectual Property  
Organization  
International Bureau(10) International Publication Number  
**WO 2023/283441 A1**(43) International Publication Date  
12 January 2023 (12.01.2023)

## (51) International Patent Classification:

A61K 9/00 (2006.01) A61K 31/00 (2006.01)

## (21) International Application Number:

PCT/US2022/036548

## (22) International Filing Date:

08 July 2022 (08.07.2022)

## (25) Filing Language:

English

## (26) Publication Language:

English

## (30) Priority Data:

63/220,362 09 July 2021 (09.07.2021) US  
63/282,356 23 November 2021 (23.11.2021) US(71) Applicant: **ASTRAZENECA PHARMACEUTICALS LP** [US/US]; 1800 Concord Pike, Wilmington, DE 19850 (US).(72) Inventors: **JOSHI, Vidya**; 121 Oyster Point Blvd, South San Francisco, CA 94080 (US). **ARCHBELL, James**; 121 Oyster Point Blvd, South San Francisco, CA 94080 (US). **LACHACZ, Kellisa**; 121 Oyster Point Blvd, South SanFrancisco, CA 94080 (US). **LAMPA, Charina**; 121 Oyster Point Blvd, South San Francisco, CA 94080 (US). **MELLO, Lauren**; 4222 Emperor Blvd, Suite 250, Durham, NC 27703 (US). **GUTIERREZ, Gertrude**; 121 Oyster Point Blvd, South San Francisco, CA 94080 (US). **LECHUGA-BALLESTEROS, David**; 121 Oyster Point Blvd, South San Francisco, CA 94080 (US). **TAN, Penny**; 121 Oyster Point Blvd, South San Francisco, CA 94080 (US). **RIEBE, Michael**; 121 Oyster Point Blvd, South San Francisco, CA 94080 (US).(74) Agent: **CHEEMA, Sangeeta, K.** et al.; Seed Intellectual Property Law Group LLP, Suite 5400, 701 Fifth Avenue, Seattle, WA 98104-7064 (US).

(81) Designated States (unless otherwise indicated, for every kind of national protection available): AE, AG, AL, AM, AO, AT, AU, AZ, BA, BB, BG, BH, BN, BR, BW, BY, BZ, CA, CH, CL, CN, CO, CR, CU, CV, CZ, DE, DJ, DK, DM, DO, DZ, EC, EE, EG, ES, FI, GB, GD, GE, GH, GM, GT, HN, HR, HU, ID, IL, IN, IQ, IR, IS, IT, JM, JO, JP, KE, KG, KH, KN, KP, KR, KW, KZ, LA, LC, LK, LR, LS, LU, LY, MA, MD, ME, MG, MK, MN, MW, MX, MY, MZ, NA,

(54) Title: COMPOSITIONS, METHODS AND SYSTEMS FOR AEROSOL DRUG DELIVERY

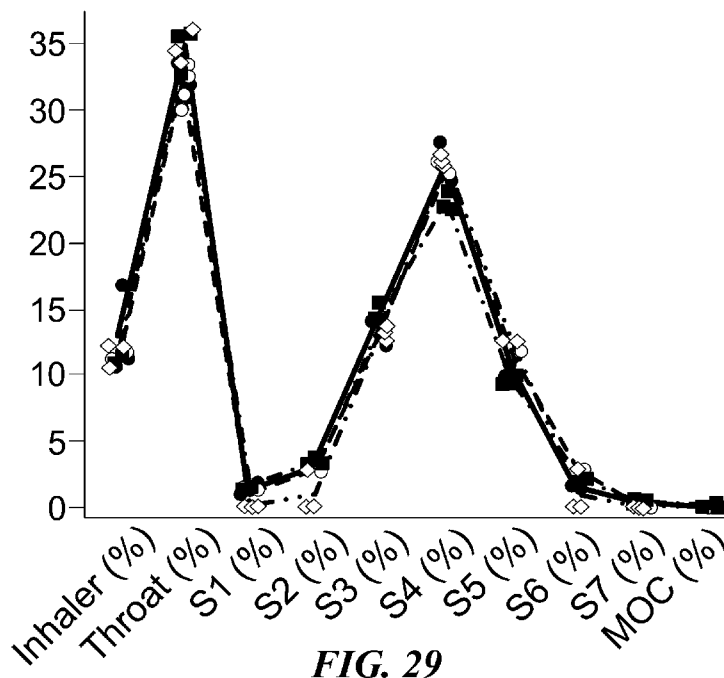


FIG. 29

(57) Abstract: Compositions, methods, and systems are provided for pulmonary delivery of active agents via a metered dose inhaler. In some embodiments, the compositions comprise an HFO-1234ze(E) suspension medium, active agent particles, and suspending particles. The active agent particles may comprise one, two, three or four active agent(s) selected from a long-acting muscarinic antagonist (LAMA), a long-acting  $\beta$ -agonists (LABA), a short-acting beta-agonists (SABA), an inhaled corticosteroid (ICS), and a non-corticosteroid anti-inflammatory agent.

[Continued on next page]



WO 2023/283441 A1

**WO 2023/283441 A1** 

NG, NI, NO, NZ, OM, PA, PE, PG, PH, PL, PT, QA, RO, RS, RU, RW, SA, SC, SD, SE, SG, SK, SL, ST, SV, SY, TH, TJ, TM, TN, TR, TT, TZ, UA, UG, US, UZ, VC, VN, WS, ZA, ZM, ZW.

- (84) Designated States** (*unless otherwise indicated, for every kind of regional protection available*): ARIPO (BW, GH, GM, KE, LR, LS, MW, MZ, NA, RW, SD, SL, ST, SZ, TZ, UG, ZM, ZW), Eurasian (AM, AZ, BY, KG, KZ, RU, TJ, TM), European (AL, AT, BE, BG, CH, CY, CZ, DE, DK, EE, ES, FI, FR, GB, GR, HR, HU, IE, IS, IT, LT, LU, LV, MC, MK, MT, NL, NO, PL, PT, RO, RS, SE, SI, SK, SM, TR), OAPI (BF, BJ, CF, CG, CI, CM, GA, GN, GQ, GW, KM, ML, MR, NE, SN, TD, TG).

**Declarations under Rule 4.17:**

- *of inventorship (Rule 4.17(iv))*

**Published:**

- *with international search report (Art. 21(3))*

## COMPOSITIONS, METHODS AND SYSTEMS FOR AEROSOL DRUG DELIVERY

### CROSS-REFERENCE TO RELATED APPLICATIONS

This application claims benefit under 35 U.S.C. §119(e) of the U.S. Provisional Application No. 63/220,362, filed July 9, 2021 and U.S. Provisional  
5 Application No. 63/282,356, filed November 23, 2021. Each of the above listed applications is incorporated by reference herein in its entirety for all purposes.

### BACKGROUND

Methods of targeted drug delivery that deliver an active agent at the site of action are often desirable. For example, targeted delivery of active agents can reduce  
10 undesirable side effects, lower dosing requirements, and decrease therapeutic costs. In the context of respiratory delivery, inhalers are well known devices for administering an active agent to a subject's respiratory tract, and several different inhaler systems are currently commercially available. Three common inhaler systems include dry powder inhalers, nebulizers, and metered dose inhalers (MDIs), also known as pressurized  
15 metered dose inhalers (pMDIs).

MDIs may be used to deliver medicaments in a solubilized form or as a suspension. Typically, MDIs use a relatively high vapor pressure propellant to expel aerosolized droplets containing an active agent into the respiratory tract when the MDI is activated. Dry powder inhalers generally rely on the patient's inspiratory efforts to  
20 introduce a medicament in a dry powder form to the respiratory tract. Nebulizers form a medicament aerosol to be inhaled by imparting energy to a liquid solution or suspension. MDI have provided a reliable, instantly available, and easy to use medical aerosol delivery system for more than sixty years. While dry powder inhalers and nebulizers both have an important role to play in the management of airway and  
25 parenchymal disease, there is not yet any all-purpose aerosol generation and delivery system to replace the MDI.

MDIs are active delivery devices that utilize the pressure generated by a propellant. The propellant must be safe for patients' use and be pharmaceutically acceptable. The active agent to be delivered by an MDI is typically provided as a

suspension of fine particulates dispersed within a propellant or a combination of two or more propellants (i.e., a propellant “system”). However, fine particles of active agent suspended in a propellant or propellant system tend to aggregate or flocculate rapidly. In turn, aggregation or flocculation of these fine particles may complicate the delivery of the active agent. Another problem associated with such suspension MDI formulations relates to crystal growth of the drug during storage, resulting in a decrease over time of aerosol properties and delivered dose uniformity of such MDIs. Thus, it is critical to properly formulate the active agents with the excipients and propellants to form a stable suspension suitable for MDI. The properties of the propellant play an important role in the performance of a suspension formulation for MDIs. For example, the liquid density, vapor pressure and water solubility of a propellant affect the suspension stability, dose uniformity, aerosol performance and moisture ingress. Other properties of a propellant, such as dipole moment, surface tension, boiling point, liquid viscosity, latent heat, etc., are also factors to be considered when formulating the suspension formulation. Historically, the phase out of chlorofluorocarbon (CFC) propellants, which are ozone-depleting agents, necessitated the reformulation of MDIs with hydrofluoroalkane (HFA) propellants. Although not ozone-depleting, HFA propellants are greenhouse gases having high global warming potential (GWP) and so there remains a need for alternative MDI propellants with reduced environmental impact. However, reformulation of MDI propellants is not a simple task – substantial new technology had to be developed to enable the switch from CFCs to HFAs in MDIs due to considerations of the physicochemical properties of various excipients and how the addition of these excipients may impact overall MDI performance. For example, one of the main challenges was that conventional surfactants used for CFC-based MDIs were not suitable for HFAs.

As there is a desire to develop new environmentally friendly MDIs, there remains a need to research and develop innovative suspension MDI formulations.

#### BRIEF SUMMARY

The present disclosure provides compositions, methods, and systems for respiratory delivery of one or more active agents.

In some embodiments, the compositions described herein are formulated for pulmonary delivery of one or more active agents via an MDI. In other embodiments, the compositions described herein may be formulated for nasal delivery via an MDI. In some embodiments, the compositions comprise a propellant of pharmaceutical grade (1*E*)-1,3,3,3-tetrafluoropropene (HFO-1234ze(E)), a plurality of active agent particles, and a plurality of phospholipid particles comprising perforated microstructures. In some embodiments, the plurality of active agent particles comprise one, two, three or four active agents selected from a long-acting muscarinic antagonist (LAMA), a long-acting  $\beta$ 2-agonist (LABA), a short-acting beta-agonist (SABA), an inhaled corticosteroid (ICS), and a non-corticosteroid anti-inflammatory agent.

In some embodiments, the compositions comprise a propellant of pharmaceutical grade (1*E*)-1,3,3,3-tetrafluoropropene (HFO-1234ze(E)), a plurality of LAMA particles, and a plurality of phospholipid particles comprising perforated microstructures. In some embodiments, the compositions comprise a propellant of pharmaceutical grade (1*E*)-1,3,3,3-tetrafluoropropene (HFO-1234ze(E)), a plurality of LABA particles, and a plurality of phospholipid particles comprising perforated microstructures. In some embodiments, the compositions comprise a propellant of pharmaceutical grade (1*E*)-1,3,3,3-tetrafluoropropene (HFO-1234ze(E)), a plurality of SABA particles, and a plurality of phospholipid particles comprising perforated microstructures. In some embodiments, the compositions comprise a propellant of pharmaceutical grade (1*E*)-1,3,3,3-tetrafluoropropene (HFO-1234ze(E)), a plurality of ICS particles, and a plurality of phospholipid particles comprising perforated microstructures. In some embodiments, the compositions comprise a propellant of pharmaceutical grade (1*E*)-1,3,3,3-tetrafluoropropene (HFO-1234ze(E)), a plurality of non-corticosteroid anti-inflammatory agent particles, and a plurality of phospholipid particles comprising perforated microstructures.

In some embodiments, the compositions comprise a propellant of pharmaceutical grade (1*E*)-1,3,3,3-tetrafluoropropene (HFO-1234ze(E)), a plurality of one or more species of active agent particles and a plurality of phospholipid particles comprising perforated microstructures. In some embodiments, the compositions comprise a propellant of pharmaceutical grade (1*E*)-1,3,3,3-tetrafluoropropene (HFO-

1234ze(E)), a plurality of a first species of active agent particle, a plurality of a second species of active agent particle, and a plurality of phospholipid particles comprising perforated microstructures. In some embodiments, the first species of active agent particles comprise a first active agent and the second species of active agent particles  
5 comprise a second active agent. In some embodiments, the compositions described herein further comprise a plurality of a third species of active agent particle, wherein the third species of active agent particle comprises a third active agent. In some embodiments, the compositions described herein further comprise a plurality of a fourth species of active agent particle, wherein the fourth species of active agent particle  
10 comprises a fourth active agent. In some embodiments, the active agents are selected from a long-acting muscarinic antagonist (LAMA), a long-acting  $\beta$ 2-agonist (LABA), a short-acting beta-agonist (SABA), an inhaled corticosteroid (ICS), and a non-corticosteroid anti-inflammatory agent. In some embodiments, the first and second active agents are selected from a long-acting muscarinic antagonist (LAMA), a long-  
15 acting  $\beta$ 2-agonist (LABA), a short-acting beta-agonist (SABA), an inhaled corticosteroid (ICS), and a non-corticosteroid anti-inflammatory agent. In further embodiments, the third active agent is selected from a long-acting muscarinic antagonist (LAMA), a long-acting  $\beta$ 2-agonist (LABA), a short-acting beta-agonist (SABA), an inhaled corticosteroid (ICS), and a non-corticosteroid anti-inflammatory  
20 agent. In yet further embodiments, the fourth active agent is selected from a long-acting muscarinic antagonist (LAMA), a long-acting  $\beta$ 2-agonist (LABA), a short-acting beta-agonist (SABA), an inhaled corticosteroid (ICS), and a non-corticosteroid anti-inflammatory agent.

The methods described herein include methods of treating a pulmonary  
25 disease or disorder in a patient by actuating a metered dose inhaler containing a composition as described herein.

Also described herein are systems for pulmonary delivery of one or more active agents. In some embodiments, such systems include an MDI comprising a canister with an outlet valve including an actuator (e.g., a depressible valve stem) for  
30 dispensing a metered amount of a composition as described herein. In some embodiments, the outlet valve is at least partially composed of bromobutyl material.

For example, an internal neck gasket of the outlet valve may comprise or consist of bromobutyl material. In addition, one or more internal seat gaskets of the outlet valve may comprise or consist of bromobutyl material.

In one embodiment, the present disclosure provides a pharmaceutical composition deliverable from a metered dose inhaler, the pharmaceutical composition comprising: a plurality of a first species of active agent particle; a plurality of a second species of active agent particle; a plurality of a third species of active agent particle; a plurality of a fourth species of active agent particle; a plurality of phospholipid particles comprising perforated microstructures; and a pharmaceutically acceptable propellant; wherein the first, second, third and fourth species of active agents are each independently selected from a long-acting muscarinic antagonist (LAMA), a long-acting  $\beta_2$ -agonists (LABA), a short-acting beta-agonists (SABA), an inhaled corticosteroid (ICS), and a non-corticosteroid anti-inflammatory agent.

In one embodiment of the pharmaceutical composition, the LAMA is selected from glycopyrrolate, dexpirronium, tiotropium, tropium, aclidinium, umeclidinium, and darotroprum; or a pharmaceutically acceptable salt or solvate thereof; the LABA is selected from bambuterol, clenbuterol, formoterol, salmeterol, carmoterol, milveterol, indacaterol, vilanterol, and saligenin- or indole-containing and adamantyl-derived  $\beta_2$  agonists; or a pharmaceutically acceptable salt or solvate thereof; the SABA is selected from bitolterol, carbuterol, fenoterol, hexoprenaline, isoprenaline (isoproterenol), levosalbutamol, orciprenaline (metaproterenol), pirbuterol, procaterol, rimiterol, albuterol (salbutamol), terbutaline, tulobuterol, reproterol, and epinephrine; or a pharmaceutically acceptable salt or solvate thereof; the ICS is selected from beclomethasone, budesonide, ciclesonide, flunisolide, fluticasone, methylprednisolone, mometasone, prednisone and triamcinolone; or a pharmaceutically acceptable salt or solvate thereof; and the non-corticosteroid anti-inflammatory agent is selected from roflumilast, apremilast, crisaborole, ruxolitinib, tofacitinib, oclacitinib, baricitinib, peficitinib, fedratinib, and upadacitinib; or a pharmaceutically acceptable salt or solvate thereof.

In another embodiment of the pharmaceutical composition, the LAMA is glycopyrrolate or a pharmaceutically acceptable salt or solvate thereof;

In another embodiment of the pharmaceutical composition, the LABA is formoterol or a pharmaceutically acceptable salt or solvate thereof.

In another embodiment of the pharmaceutical composition, the SABA is albuterol or a pharmaceutically acceptable salt or solvate thereof.

5 In another embodiment of the pharmaceutical composition, the ICS is budesonide or a pharmaceutically acceptable salt or solvate thereof.

In another embodiment of the pharmaceutical composition, the non-corticosteroid anti-inflammatory agent is roflumilast or a pharmaceutically acceptable salt or solvate thereof.

10 In another embodiment of the pharmaceutical composition, the LAMA is present at a concentration in the range of about 0.04 mg/mL to about 2.25 mg/mL.

In another embodiment of the pharmaceutical composition, the LABA is present at a concentration in the range of about 0.01 mg/mL to about 1 mg/mL.

15 In another embodiment of the pharmaceutical composition, the ICS is present at a concentration in the range of about 0.1 mg/mL to about 20 mg/mL.

In another embodiment of the pharmaceutical composition, the SABA is present at a concentration in the range of about 0.1 mg/mL to about 20 mg/mL.

20 In another embodiment of the pharmaceutical composition, the non-corticosteroid anti-inflammatory agent is present at a concentration in the range of about 0.03 mg/mL to about 3 mg/mL

In one embodiment of the pharmaceutical composition, the perforated microstructures comprise 1,2-Distearoyl-sn-glycero-3-phosphocholine (DSPC). In another embodiment, the perforated microstructures further comprise calcium chloride.

25 In another embodiment of the pharmaceutical composition, the phospholipid particles are present at a concentration in the range of about 0.1 mg/mL to about 10 mg/mL.

30 In another embodiment, the pharmaceutical composition comprises a plurality of glycopyrrolate particles; a plurality of formoterol particles; a plurality of budesonide particles; a plurality of roflumilast particles; and a plurality of phospholipid particles comprising perforated microstructures; and a pharmaceutically acceptable propellant.

In another embodiment of the pharmaceutical composition, the glycopyrrolate particles are in the propellant at a concentration sufficient to provide a delivered dose of glycopyrrolate per actuation of the metered dose inhaler selected from between about 5  $\mu\text{g}$  and about 50  $\mu\text{g}$  per actuation, between about 2  $\mu\text{g}$  and about 25  $\mu\text{g}$  per actuation, and between about 6  $\mu\text{g}$  and about 15  $\mu\text{g}$  per actuation.

In another embodiment of the pharmaceutical composition, the glycopyrrolate particles comprise micronized and crystalline glycopyrronium bromide.

In another embodiment of the pharmaceutical composition, the formoterol particles are included in the composition at a concentration sufficient to provide a delivered dose of formoterol selected from between about 1  $\mu\text{g}$  and about 30  $\mu\text{g}$ , between about 0.5  $\mu\text{g}$  and about 10  $\mu\text{g}$ , between about 2  $\mu\text{g}$  and 5  $\mu\text{g}$ , between about 3  $\mu\text{g}$  and about 10  $\mu\text{g}$ , between about 5  $\mu\text{g}$  and about 10  $\mu\text{g}$ , and between 3  $\mu\text{g}$  and about 30  $\mu\text{g}$  per actuation of the metered dose inhaler.

In another embodiment of the pharmaceutical composition, the formoterol particles comprise micronized and crystalline formoterol fumarate.

In another embodiment of the pharmaceutical composition, the budesonide particles are included in the composition at a concentration sufficient to provide a delivered dose of budesonide selected from between about 50  $\mu\text{g}$  and about 400  $\mu\text{g}$ , between about 20  $\mu\text{g}$  and about 600  $\mu\text{g}$ , between about 30  $\mu\text{g}$  and 100  $\mu\text{g}$ , between about 50  $\mu\text{g}$  and about 200  $\mu\text{g}$ , and between about 150  $\mu\text{g}$  and about 350  $\mu\text{g}$  per actuation of the metered dose inhaler.

In another embodiment of the pharmaceutical composition, the budesonide particles comprise micronized budesonide.

In another embodiment of the pharmaceutical composition, the roflumilast particles comprise micronized and crystalline roflumilast.

In another embodiment of the pharmaceutical composition, the roflumilast particles are included in the composition at a concentration sufficient to provide a delivered dose of budesonide selected from between about 1  $\mu\text{g}$  and about 100  $\mu\text{g}$ , about 5  $\mu\text{g}$  and about 80  $\mu\text{g}$ , about 5  $\mu\text{g}$  and about 50  $\mu\text{g}$ , about 5  $\mu\text{g}$  and about 25  $\mu\text{g}$ , about 10  $\mu\text{g}$  and 25  $\mu\text{g}$ , about 50  $\mu\text{g}$  and about 400  $\mu\text{g}$ , between about 20  $\mu\text{g}$  and

about 600 µg, between about 30 µg and 100 µg, between about 50 µg and about 200 µg, and between about 150 µg and about 350 µg per actuation of the metered dose inhaler.

In another embodiment of the pharmaceutical composition, the phospholipid particles are included in the composition at a concentration sufficient to provide a delivered dose of the phospholipid particles selected from between about 50 µg and about 400 µg.

In another embodiment of the pharmaceutical composition, the pharmaceutically acceptable propellant is selected from HFA, HFC, HFO, and a combination thereof.

In one embodiment, the present disclosure provides a metered dose inhaler comprising a canister with an outlet valve including an actuator for dispensing a metered amount of a pharmaceutical composition according to any one of the aforementioned embodiments, wherein the canister contains the pharmaceutical composition.

In one embodiment of the metered dose inhaler, the outlet valve comprises a neck gasket and at least one seat gasket; and the neck gasket or the at least one seat gasket is composed of bromobutyl material.

In one embodiment, the metered dose inhaler exhibits less than about 10%, 9%, 8%, 7%, 6%, or 5% reduced shot weight per actuation throughout emptying of the canister.

In one embodiment, the metered dose inhaler exhibits less than about 1.0%, 0.5%, 0.4%, 0.3%, 0.2%, or 0.1% weight loss at 25°C/60% RH per year.

In one embodiment, the metered dose inhaler exhibits a delivered dose uniformity (DDU) for the pharmaceutical formulation selected from a DDU of ± 20%, or better, a DDU of ± 15%, or better, and a DDU of ± 10%, or better, throughout emptying of the canister.

In one embodiment, the present disclosure provides a method of treating a pulmonary disease or disorder in a patient, comprising administering a pharmaceutical composition according to any one of the aforementioned embodiments to the patient by actuating a metered dose inhaler according to any one of the aforementioned

embodiments; wherein the metered dose inhaler contains the pharmaceutical composition.

In one embodiment of the method, the pulmonary disease or disorder is asthma or COPD.

5 In one embodiment, the present disclosure provides a pharmaceutical composition according to any one of the aforementioned embodiments for use in the manufacture of a medicament for the treatment of a pulmonary disease or disorder.

In one embodiment, the present disclosure provides a pharmaceutical composition according to any one of the aforementioned embodiments for use in the  
10 treatment of a pulmonary disease or disorder.

#### BRIEF DESCRIPTION OF THE SEVERAL VIEWS OF THE DRAWINGS

**FIG. 1** is an isometric view of an aerosol delivery unit in the form of an MDI, according to one example embodiment.

15 **FIG. 2** is an exploded isometric view of the aerosol delivery unit of **FIG. 1**.

**FIG. 3A** is a side view of the aerosol delivery unit of **FIG. 1** with a portion thereof illustrated in cross-section, showing the unit in a standby or storage configuration in which the discharge passageway is exposed to a desiccant material.

20 **FIG. 3B** is a side view of the aerosol delivery unit of **FIG. 1** with a portion thereof illustrated in cross-section, showing the unit in a discharge configuration in which the discharge passageway is temporarily isolated from the desiccant material as aerosolized matter is discharged from the canister into an inhalation passageway for delivery to a user.

25 **FIG. 4** is a perspective view of an outlet valve of a canister suitable for use in connection with the aerosol delivery unit of **FIGs 1** through **3B**.

**FIG. 5** is a CT scan of a discharge passageway of an MDI according to certain aspects of the present disclosure, showing a discharge orifice of the MDI substantially free of deposited or accumulated matter despite repeated use of the MDI to  
30 dispense formulations described herein.

**FIG. 6** is a chart illustrating formulation weight loss over time for a variety of MDI canisters including an outlet valve with internal gaskets of different materials, when filled with a formulation comprising an HFO propellant.

**FIG. 7** shows individual deposition distributions for active agent particles dispensed from an MDI containing a triple co-suspension of glycopyrrolate, budesonide, and formoterol active agent particles suspended in HFO-1234ze(E) propellant with phospholipid suspending particles.

**FIG. 8** shows the deposition distribution of formoterol active agent particles dispensed from an MDI containing a triple co-suspension of glycopyrrolate, budesonide, and formoterol active agent particles suspended in HFO-1234ze(E) propellant with phospholipid suspending particles, at several different relative humidity levels.

**FIG. 9** shows the deposition distribution of budesonide active agent particles dispensed from an MDI containing a triple co-suspension of glycopyrrolate, budesonide, and formoterol active agent particles suspended in HFO-1234ze(E) propellant with phospholipid suspending particles, at several different relative humidity levels.

**FIG. 10A** shows the fine particle fraction (FPF) present in the delivered dose upon actuation of an MDI containing budesonide, formoterol, or glycopyrrolate active agent particles and phospholipid particles, as measured following storage of the MDI under at 25°C and 60% relative humidity for the indicated periods of time.

**FIG. 10B** shows the fine particle fraction (FPF) present in the delivered dose upon actuation of an MDI containing budesonide, formoterol, or glycopyrrolate active agent particles and phospholipid particles, as measured following storage of the MDI under at 40°C and 75% relative humidity for the indicated periods of time.

**FIG. 10C** shows the fine particle fraction (FPF) present in the delivered dose upon actuation of an MDI containing budesonide, formoterol, or glycopyrrolate active agent particles and phospholipid particles, as measured following storage of the MDI under at 30°C and 65% relative humidity for the indicated periods of time.

**FIG. 11A** shows the fine particle mass (FPM) present in the delivered dose upon actuation of an MDI containing budesonide and phospholipid particles, as

measured following storage of the MDI at 25°C and 60% relative humidity for the indicated periods of time.

**FIG. 11B** shows the fine particle mass (FPM) present in the delivered dose upon actuation of an MDI containing budesonide and phospholipid particles, as measured following storage of the MDI at 40°C and 75% relative humidity for the indicated periods of time.

**FIG. 11C** shows the fine particle mass (FPM) present in the delivered dose upon actuation of an MDI containing budesonide and phospholipid particles, as measured following storage of the MDI at 30°C and 65% relative humidity for the indicated periods of time.

**FIG. 12A** shows measurements of degradation of budesonide active agent particles in an MDI canister containing active agent particles and phospholipid particles following storage of the MDI at 25°C and 60% relative humidity for the indicated periods of time.

**FIG. 12B** shows measurements of degradation of budesonide active agent particles in an MDI canister containing active agent particles and phospholipid particles following storage of the MDI at 40°C and 75% relative humidity for the indicated periods of time.

**FIG. 12C** shows measurements of degradation of budesonide active agent particles in an MDI canister containing active agent particles and phospholipid particles following storage of the MDI at 30°C and 65% relative humidity for the indicated periods of time.

**FIG. 13A** shows measurements of degradation of glycopyrrolate active agent particles in an MDI canister containing active agent particles and phospholipid particles following storage of the MDI at 25°C and 60% relative humidity for the indicated periods of time.

**FIG. 13B** shows measurements of degradation of glycopyrrolate active agent particles in an MDI canister containing active agent particles and phospholipid particles following storage of the MDI at 40°C and 75% relative humidity for the indicated periods of time.

**FIG. 13C** shows measurements of degradation of glycopyrrolate active agent particles in an MDI canister containing active agent particles and phospholipid particles following storage of the MDI at 30°C and 65% relative humidity for the indicated periods of time.

5 **FIG. 14A** shows the delivered dose uniformity (DDU) upon actuation of an MDI containing budesonide active agent particles and phospholipid particles following storage of the MDI at 25°C and 60% relative humidity for the indicated periods of time.

**FIG. 14B** shows the delivered dose uniformity (DDU) upon actuation of  
10 an MDI containing budesonide active agent particles and phospholipid particles following storage of the MDI at 40°C and 75% relative humidity for the indicated periods of time.

**FIG. 14C** shows the delivered dose uniformity (DDU) upon actuation of  
an MDI containing budesonide active agent particles and phospholipid particles  
15 following storage of the MDI at 30°C and 65% relative humidity for the indicated periods of time.

**FIG. 15** shows BD, FF, and DSPC Aerodynamic Particle Size Distribution by NGI of BFF-1234ze.

**FIG. 16** shows aerodynamic particle size distribution by NGI of BD  
20 comparing BFF-1234ze and BFF-134a formulations.

**FIG. 17** shows aerodynamic particle size distribution by NGI of FF comparing BFF-1234ze and BFF-134a formulations.

**FIG. 18** shows BD aerodynamic Particle Size Distribution by NGI  
Stability Data for BFF-1234ze, 25°C/60% RH - Valve Down, Protected at initial, 6  
25 months, and 12 months.

**FIG. 19** shows FF Aerodynamic Particle Size Distribution by NGI  
Stability Data for BFF-1234ze, 25°C/60% RH - Valve Down, Protected at initial, 6  
months, and 12 months.

**FIG. 20** shows DSPC Aerodynamic Particle Size Distribution by NGI  
30 Stability Data for BFF-1234ze, 25°C/60% RH - Valve Down, Protected at initial, 6  
months, and 12 months.

**FIG. 21** shows BD and FF Delivered Dose Uniformity Stability Data for BFF-1234ze, 25°C/60% RH - Valve Down, Protected.

**FIG. 22** shows BD, AB, and DSPC Aerodynamic Particle Size Distribution by NGI of BDA-1234ze.

5 **FIG. 23** shows Aerodynamic particle size distribution by NGI of BD comparing BDA-1234ze and BDA-134a formulations.

**FIG. 24** shows Aerodynamic particle size distribution by NGI of AB comparing BDA-1234ze and BDA-134a formulations.

**FIG. 25** shows BD aerodynamic Particle Size Distribution by NGI  
10 Stability Data for BDA-1234ze, 25°C/60% RH - Valve Down, Protected at initial, 6 months, and 12 months.

**FIG. 26** shows AB Aerodynamic Particle Size Distribution by NGI  
Stability Data for BDA-1234ze, 25°C/60% RH - Valve Down, Protected at initial, 6  
months, and 12 months.

15 **FIG. 27** shows BD and AB Delivered Dose Uniformity Stability Data for BDA-1234ze, 25°C/60% RH - Valve Down, Protected.

**FIG. 28** shows GP and FF Aerodynamic Particle Size Distribution by NGI of GFF-1234ze.

**FIG. 29** shows BD, GP, FF, and RF Aerodynamic Particle Size  
20 Distribution by NGI of BGFR-1234ze.

**FIG. 30** shows the deposition distribution of budesonide, glycopyrrolate, formoterol, and roflumilast active agent particles dispensed from an MDI containing a quadruple co-suspension of glycopyrrolate, budesonide, formoterol and roflumilast active agent particles suspended in HFO-1234ze(E) propellant with phospholipid  
25 suspending particles.

**FIG. 31A** shows the deposition distribution of roflumilast active agent particles dispensed from an MDI containing a quadruple co-suspension of glycopyrrolate, budesonide, and formoterol and roflumilast active agent particles suspended in HFO-1234ze(E) propellant with phospholipid suspending particles upon  
30 actuation after 3 months in stability storage conditions representative of accelerated

stability (40°C/75% RH -Valve Down, Protected) and 3 months in stability storage conditions representative of real-time stability (25°C/60% RH -Valve Down, Protected).

**FIG. 31B** shows the deposition distribution of budesonide active agent particles dispensed from an MDI containing a quadruple co-suspension of glycopyrrolate, budesonide, and formoterol and roflumilast active agent particles suspended in HFO-1234ze(E) propellant with phospholipid suspending particles upon actuation after 3 months in stability storage conditions representative of accelerated stability (40°C/75% RH -Valve Down, Protected) and 3 months in stability storage conditions representative of real-time stability (25°C/60% RH -Valve Down, Protected).

**FIG. 31C** shows the deposition distribution of glycopyrrolate active agent particles dispensed from an MDI containing a quadruple co-suspension of glycopyrrolate, budesonide, and formoterol and roflumilast active agent particles suspended in HFO-1234ze(E) propellant with phospholipid suspending particles upon actuation after 3 months in stability storage conditions representative of accelerated stability (40°C/75% RH -Valve Down, Protected) and 3 months in stability storage conditions representative of real-time stability (25°C/60% RH -Valve Down, Protected).

**FIG. 31D** shows the deposition distribution of formoterol active agent particles dispensed from an MDI containing a quadruple co-suspension of glycopyrrolate, budesonide, and formoterol and roflumilast active agent particles suspended in HFO-1234ze(E) propellant with phospholipid suspending particles upon actuation after 3 months in stability storage conditions representative of accelerated stability (40°C/75% RH -Valve Down, Protected) and 3 months in stability storage conditions representative of real-time stability (25°C/60% RH -Valve Down, Protected).

**FIG. 32** shows the delivered dose uniformity (DDU) of roflumilast, formoterol, budesonide and glycopyrrolate active agent particles dispensed at the beginning and life and at the end of life from an MDI containing a quadruple co-suspension of glycopyrrolate, budesonide, and formoterol and roflumilast active agent particles suspended in HFO-1234ze(E) propellant with phospholipid suspending particles.

**FIG. 33A** shows the delivered dose uniformity (DDU) of roflumilast active agent particles dispensed at the beginning and life and at the end of life from an

MDI containing a quadruple co-suspension of glycopyrrolate, budesonide, and formoterol and roflumilast active agent particles suspended in HFO-1234ze(E) propellant with phospholipid suspending particles after 3 months in stability storage conditions representative of accelerated stability (40°C/75% RH -Valve Down, Protected) and 3 months in stability storage conditions representative of real-time stability (25°C/60% RH -Valve Down, Protected).

**FIG. 33B** shows the delivered dose uniformity (DDU) of formoterol active agent particles dispensed at the beginning and life and at the end of life from an MDI containing a quadruple co-suspension of glycopyrrolate, budesonide, and formoterol and roflumilast active agent particles suspended in HFO-1234ze(E) propellant with phospholipid suspending particles after 3 months in stability storage conditions representative of accelerated stability (40°C/75% RH -Valve Down, Protected) and 3 months in stability storage conditions representative of real-time stability (25°C/60% RH -Valve Down, Protected).

**FIG. 33C** shows the delivered dose uniformity (DDU) of budesonide active agent particles dispensed at the beginning and life and at the end of life from an MDI containing a quadruple co-suspension of glycopyrrolate, budesonide, and formoterol and roflumilast active agent particles suspended in HFO-1234ze(E) propellant with phospholipid suspending particles after 3 months in stability storage conditions representative of accelerated stability (40°C/75% RH -Valve Down, Protected) and 3 months in stability storage conditions representative of real-time stability (25°C/60% RH -Valve Down, Protected).

**FIG. 33D** shows the delivered dose uniformity (DDU) of glycopyrrolate active agent particles dispensed at the beginning and life and at the end of life from an MDI containing a quadruple co-suspension of glycopyrrolate, budesonide, and formoterol and roflumilast active agent particles suspended in HFO-1234ze(E) propellant with phospholipid suspending particles after 3 months in stability storage conditions representative of accelerated stability (40°C/75% RH -Valve Down, Protected) and 3 months in stability storage conditions representative of real-time stability (25°C/60% RH -Valve Down, Protected).

**FIG. 34** shows the deposition distribution of budesonide, glycopyrrolate, formoterol, and roflumilast active agent particles dispensed from an MDI containing a quadruple co-suspension of glycopyrrolate, budesonide, formoterol and roflumilast active agent particles suspended in HFA-134a propellant with phospholipid suspending particles.

**FIGS. 35A** shows the deposition distribution of roflumilast active agent particles dispensed from an MDI containing a quadruple co-suspension of glycopyrrolate, budesonide, and formoterol and roflumilast active agent particles suspended in HFA-134a propellant with phospholipid suspending particles upon actuation after 3 months in stability storage conditions representative of accelerated stability (40°C/75% RH -Valve Down, Protected) and 3 months in stability storage conditions representative of real-time stability (25°C/60% RH -Valve Down, Protected).

**FIG. 35B** shows the deposition distribution of budesonide active agent particles dispensed from an MDI containing a quadruple co-suspension of glycopyrrolate, budesonide, and formoterol and roflumilast active agent particles suspended in HFA-134a propellant with phospholipid suspending particles upon actuation after 3 months in stability storage conditions representative of accelerated stability (40°C/75% RH -Valve Down, Protected) and 3 months in stability storage conditions representative of real-time stability (25°C/60% RH -Valve Down, Protected).

**FIG. 35C** shows the deposition distribution of glycopyrrolate active agent particles dispensed from an MDI containing a quadruple co-suspension of glycopyrrolate, budesonide, and formoterol and roflumilast active agent particles suspended in HFA-134a propellant with phospholipid suspending particles upon actuation after 3 months in stability storage conditions representative of accelerated stability (40°C/75% RH -Valve Down, Protected) and 3 months in stability storage conditions representative of real-time stability (25°C/60% RH -Valve Down, Protected).

**FIG. 35D** shows the deposition distribution of formoterol active agent particles dispensed from an MDI containing a quadruple co-suspension of glycopyrrolate, budesonide, and formoterol and roflumilast active agent particles suspended in HFA-134a propellant with phospholipid suspending particles upon actuation after 3 months in stability storage conditions representative of accelerated

stability (40°C/75% RH -Valve Down, Protected) and 3 months in stability storage conditions representative of real-time stability (25°C/60% RH -Valve Down, Protected).

**FIG. 36** shows the delivered dose uniformity (DDU) of roflumilast, formoterol, budesonide and glycopyrrolate active agent particles dispensed at the beginning and life and at the end of life from an MDI containing a quadruple co-suspension of glycopyrrolate, budesonide, and formoterol and roflumilast active agent particles suspended in HFA-134a propellant with phospholipid suspending particles.

**FIG. 37A** shows the delivered dose uniformity (DDU) of roflumilast active agent particles dispensed at the beginning and life and at the end of life from an MDI containing a quadruple co-suspension of glycopyrrolate, budesonide, and formoterol and roflumilast active agent particles suspended in HFA-134a propellant with phospholipid suspending particles after 3 months in stability storage conditions representative of accelerated stability (40°C/75% RH -Valve Down, Protected) and 3 months in stability storage conditions representative of real-time stability (25°C/60% RH -Valve Down, Protected).

**FIG. 37B** shows the delivered dose uniformity (DDU) of formoterol active agent particles dispensed at the beginning and life and at the end of life from an MDI containing a quadruple co-suspension of glycopyrrolate, budesonide, and formoterol and roflumilast active agent particles suspended in HFA-134a propellant with phospholipid suspending particles after 3 months in stability storage conditions representative of accelerated stability (40°C/75% RH -Valve Down, Protected) and 3 months in stability storage conditions representative of real-time stability (25°C/60% RH -Valve Down, Protected).

**FIG. 37C** shows the delivered dose uniformity (DDU) of budesonide active agent particles dispensed at the beginning and life and at the end of life from an MDI containing a quadruple co-suspension of glycopyrrolate, budesonide, and formoterol and roflumilast active agent particles suspended in HFA-134a propellant with phospholipid suspending particles after 3 months in stability storage conditions representative of accelerated stability (40°C/75% RH -Valve Down, Protected) and 3 months in stability storage conditions representative of real-time stability (25°C/60% RH -Valve Down, Protected).

**FIG. 37D** shows the delivered dose uniformity (DDU) of glycopyrrolate active agent particles dispensed at the beginning and life and at the end of life from an MDI containing a quadruple co-suspension of glycopyrrolate, budesonide, and formoterol and roflumilast active agent particles suspended in HFA-134a propellant with phospholipid suspending particles after 3 months in stability storage conditions representative of accelerated stability (40°C/75% RH -Valve Down, Protected) and 3 months in stability storage conditions representative of real-time stability (25°C/60% RH -Valve Down, Protected).

**FIG. 38** shows budesonide and formoterol fumarate aerodynamic particle size distribution by Next Generation Impactor (NGI) of HFA-134a (BFF-134a) and HFO-1234ze (BFF-1234ze).

**FIG. 39** shows budesonide and formoterol fumarate aerodynamic particle size distribution by Next Generation Impactor (NGI) of HFA-134a (BFF crystal-134a) and HFO-1234ze (BFF crystal-1234ze).

**FIG. 40** shows budesonide, glycopyrronium, and formoterol fumarate aerodynamic particle size distribution by Next Generation Impactor (NGI) of HFA-134a (BGF-134a) and HFO-1234ze (BGF-1234ze).

**FIG. 41** shows budesonide, glycopyrronium, and formoterol fumarate aerodynamic particle size distribution by Next Generation Impactor (NGI) of HFA-134a (BGF crystal-134a) and HFO-1234ze (BGF-1234ze).

## DETAILED DESCRIPTION

### *Definitions*

Unless specifically defined otherwise, the technical terms, as used herein, have their normal meaning as understood in the art. The following terms are specifically defined for the sake of clarity.

The term “active agent” is used herein to include any agent, drug, compound, composition, or other substance that may be used on, or administered to, a human or animal for any purpose, including therapeutic, pharmaceutical,

pharmacological, diagnostic, cosmetic, and prophylactic agents and immunomodulators. Active agent may be used interchangeably with the terms drug, pharmaceutical, medicament, drug substance, or therapeutic. As used herein, active agent may also encompass natural or homeopathic products that are not generally  
5 considered therapeutic.

The terms “associate,” “associate with,” or “association” refer to an interaction or relationship between a chemical entity, composition, or structure in a condition of proximity of a surface, such as the surface of another chemical entity, composition, or structure. Association includes, for example, adsorption, adhesion,  
10 covalent bonding, hydrogen bonding, ionic bonding and electrostatic attraction, Lifshitz-van der Waals interactions, and polar interactions. The terms “adhere” or “adhesion” refer to a form of association, and are used as generic terms for all forces tending to cause a particle or mass to be attracted to a surface. Adhere also refers to bringing and keeping particles in contact with each other, such that there is substantially no visible  
15 separation between particles due to their different buoyancies in a propellant under normal conditions. In one embodiment, a particle that attaches to or binds to a surface is encompassed by the term adhere. Normal conditions may include storage at room temperature or under an accelerative force due to gravity. As described herein, active particles may associate with suspending particles to form a co-suspension, where there  
20 is substantially no visible separation between the suspending particles and the active agent particles or flocculates thereof due to differences in buoyance within a propellant.

“Suspending particles” refer to a material or combination of materials that is acceptable for respiratory delivery and acts as a vehicle for active agent particles. Suspending particles interact with the active agent particle to facilitate repeatable  
25 dosing, delivery, or transport of active agent to the target site of delivery, i.e., the respiratory tract. The suspending particles described herein are dispersed within a suspension medium including a propellant or propellant system, and can be configured according to any shape, size, or surface characteristic suited to achieving a desired suspension stability or active agent delivery performance. Exemplary suspending  
30 particles include particles that exhibit a particle size that facilitates respiratory delivery

of active agent and have physical configurations suited to formulation and delivery of the stabilized suspensions as described herein.

The term “co-suspension” refers to a suspension of two or more types of particles having different compositions within a suspension medium, wherein one type of particle associates at least partially with one or more of the other particle types. The association leads to an observable change in one or more characteristics of at least one of the individual particle types suspended in the suspension medium. Characteristics modified by the association may include, for example, one or more of the rate of aggregation or flocculation, the rate and nature of separation, i.e., sedimentation or creaming, density of a cream or sediment layer, adhesion to container walls, adhesion to valve components, and the rate and level of dispersion upon agitation. The term co-suspension includes partial co-suspensions, where a majority of the at least two particle types associate with each other, however, some separation (i.e., less than a majority) of the at least two particle types may be observed.

The term “metered dose” or “actuated dose” refers to the amount of active agent contained in the volume of formulation that exits the canister upon actuation of an MDI. The term “delivered dose” refers to the amount of active agent contained in the volume of formulation that exits the actuator nozzle and is available to be drawn into a patient’s lungs. In some embodiments, the delivered dose is about 85% to about 95% of the metered dose.

In the context of a composition containing or providing respirable aggregates, particles, drops, etc., such as compositions described herein, the term “fine particle dose” or “FPD” refers to the dose, either in total mass or fraction of the nominal dose or metered dose, that is within a respirable range. The dose that is within the respirable range in measured *in vitro* to be the sum of the dose delivered at stages 3 through Micro Orifice Collector in a Next Generation Impactor operated at a flow rate of 30 l/min.

In the context of a composition containing or providing respirable aggregates, particles, drops, etc., such as compositions described herein, the term “fine particle fraction” or “FPF” refers to the proportion of the delivered material relative to the delivered dose (i.e., the amount that exits the actuator of a delivery device, such as

an MDI) that is within a respirable range. The amount of delivered material within the respirable range is measured *in vitro* as the sum of the material delivered at stages 3 through Micro Orifice Collector in a Next Generation Impactor operated at a flow rate of 30 l/min.

5 As used herein, the term “inhibit” refers to a measurable lessening of the tendency of a phenomenon, symptom, or condition to occur or the degree to which that phenomenon, symptom, or condition occurs. The term “inhibit”, or any form thereof, is used in its broadest sense and includes minimize, prevent, reduce, repress, suppress, curb, constrain, restrict, slow progress of, and the like.

10 “Mass median aerodynamic diameter” or “MMAD” as used herein refers to the aerodynamic diameter of an aerosol below which 50% of the mass of the aerosol consists of particles with an aerodynamic diameter smaller than the MMAD, with the MMAD being calculated according to monograph 601 of the United States Pharmacopeia (“USP”).

15 When referred to herein, the term “optical diameter” indicates the size of a particle as measured by the Fraunhofer diffraction mode using a laser diffraction particle size analyzer equipped with a dry powder dispenser (e.g., Sympatec GmbH, Clasthal-Zellerfeld, Germany).

The term “solution mediated transformation” refers to the phenomenon  
20 in which a more soluble form of a solid material (i.e., particles with small radius of curvature (a driving force for Ostwald ripening), or amorphous material) dissolves and recrystallizes into the more stable crystal form that can coexist in equilibrium with its saturated propellant solution.

A “patient” refers to an animal in which the one or more active agents as  
25 described herein will have a therapeutic effect. In some embodiments, the patient is a human being.

“Perforated microstructures” refers to suspending particles that include a structural matrix that exhibits, defines, or comprises voids, pores, defects, hollows, spaces, interstitial spaces, apertures, perforations, or holes that allow the surrounding  
30 suspension medium to permeate, fill, or pervade the microstructure, such as those materials and preparations described in U.S. Patent No. 6, 309,623 to Weers, et al.,

which methods are incorporated herein by reference, and in U.S. Patent No. 8,815,258, U.S. Patent No. 9,463,161, and U.S. Patent Application Publication 2011/0135737. The primary form of the perforated microstructure is, generally, not essential, and any overall configuration that provides the desired formulation characteristics is contemplated herein. Accordingly, in some embodiments, the perforated microstructures may comprise approximately spherical shapes, such as hollow, porous, spray-dried microspheres. However, collapsed, corrugated, deformed, or fractured particulates of any primary form or aspect ratio may also be compatible.

As is true of the suspending particles described herein, perforated microstructures may be formed of any biocompatible material that does not substantially degrade or dissolve in the selected suspension medium. While a wide variety of materials may be used to form the particles, in some embodiments, the structural matrix is associated with, or includes, a surfactant such as a phospholipid or fluorinated surfactant.

The term “suspension medium” as used herein refers to a substance providing a continuous phase within which active agent particles and suspending particles can be dispersed to provide a co-suspension formulation. The suspension medium used in formulations described herein includes propellant. As used herein, the term “propellant” refers to one or more pharmacologically inert substances which exert a sufficiently high vapor pressure at normal room temperature to propel a medicament from the canister of an MDI to a patient on actuation of the MDI’s metering valve. Therefore, the term “propellant” refers to both a single propellant and to a combination of two or more different propellants forming a “propellant system.”

The term “respirable” generally refers to particles, aggregates, drops, etc. sized such that they can be inhaled and reach the airways of the lung.

When used to refer to compositions described herein, the terms “physical stability” and “physically stable” refer to a composition that is resistant to one or more of aggregation, flocculation, and particle size changes due to solution mediated transformations and is capable of substantially maintaining the MMAD of suspending particles and the fine particle dose. In some embodiments, physical stability may be

evaluated through subjecting compositions to accelerated degradation conditions, such as by temperature cycling.

When referring to active agents, the term “potent” indicates active agents that are therapeutically effective at or below doses ranging from about 0.01 mg/kg to about 1 mg/kg. Typical doses of potent active agents generally range from about 100 µg to about 100 mg.

When referring to active agents, the term “highly potent” indicates active agents that are therapeutically effective at or below doses of about 10 µg/kg. Typical doses of highly potent active agents generally range up to about 100 µg.

The terms “suspension stability” and “stable suspension” refer to suspension formulations capable of maintaining the properties of a co-suspension of active agent particles and suspending particles over a period of time. In some embodiments, suspension stability may be measured through delivered dose uniformity achieved by compositions described herein.

The term “substantially insoluble” means that a composition is either totally insoluble in a particular solvent or it is poorly soluble in that particular solvent. Substantially insoluble means that a particular solute has a solubility of less than one part per 100 parts solvent. The term substantially insoluble includes the definitions of “slightly soluble” (from 100 to 1000 parts solvent per one part solute), “very slightly soluble” (from 1000 to 10,000 parts solvent per one part solute), and “practically insoluble” (more than 10,000 parts solvent per one part solute) as given in Table 16-1 of Remington: The Science and Practice of Pharmacy, 21<sup>st</sup> ed. Lippincott, Williams & Wilkins, 2006, p. 212.

The term “surfactant” as used herein refers to any agent with preferentially adsorbs to an interface between two immiscible phases, such as the interface between water and an organic polymer solution, a water/air interface, or an organic solvent/air interface. Surfactants generally possess a hydrophilic moiety and a lipophilic moiety, such that upon adsorbing to microparticles they tend to present moieties to the continuous phase that do not attract similarly-coated particles, thus reducing particle agglomeration.

A “therapeutically effective amount” is the amount of compound which achieves a therapeutic effect by inhibiting a disease or disorder in a patient or by prophylactically inhibiting or preventing the onset of a disease or disorder. A therapeutically effective amount may be an amount which relieves to some extent one or more symptoms of a disease or disorder in a patient; returns to normal either partially or completely one or more physiological or biochemical parameters associated with or causative of the disease or disorder; and/or reduces the likelihood of the onset of the disease or disorder.

The terms “chemically stable” and “chemical stability” refer to formulations wherein the individual degradation products of active agent remain below the limits specified by regulatory requirements during the shelf life of the product for human use (e.g., 1% of total chromatographic peak area per ICH guidance Q3B(R2)) and there is acceptable mass balance (e.g., as defined in ICH guidance Q1E) between active agent assay and total degradation products.

### 15 *Compositions*

The compositions described herein comprise a suspension medium including a propellant, active agent particles, and suspending particles. If desired, the compositions described herein may include one or more additional constituents. Moreover, variations and combinations of components of the compositions described herein may be used. For example, the active agent particles included in the compositions may include two or more active agents; or two or more different species of active agent particles may be used, with each different species of active agent particle comprising a different active agent. In some embodiments, two or more species of suspending particles may be used in compositions for the delivery of two or more active agents or active agent particles. In some embodiments, when two or more active agent particles are present, the present composition is in form of a fixed dose combination. By “fixed dose combination”, it is meant two or more active agents in a single dose form, such as a formulation in a single metered dose inhaler.

Generally, due to density differences between distinct species of particles and the medium within which they are suspended (e.g., a propellant or

propellant system), buoyancy forces cause creaming of particles with lower density than the propellant and sedimentation of particles with higher density than the propellant. Therefore, in suspensions that consist of a mixture of different types of particles with different density or different tendencies to flocculate, sedimentation or creaming  
5 behavior is expected to be specific to each of the different particle types and to the specific suspension medium used, and is expected to lead to separation of the different particle types within the suspension medium.

However, the combinations of propellant, active agent particles, and suspending particles described herein provide co-suspensions wherein active agent  
10 particles and suspending particles co-locate within the propellant (i.e., the active agent particles associate with the suspending particles such that suspending particles and active agent particles do not exhibit substantial separation relative to each other, such as by differential sedimentation or creaming, even after a time sufficient for the formation of a cream or sediment layer). In particular, the active agent particles associate with the  
15 suspending particles such that there is no substantial separation of active agent particles and suspending particles within the continuous phase formed by the suspension medium under typical patient use conditions.

Compositions of propellant, active agent particles, and suspending particles according to the present description provide desirable chemical stability,  
20 suspension stability, and active agent delivery characteristics. For example, in certain embodiments, when present within an MDI canister, compositions as described herein can inhibit or reduce one or more of the following: flocculation of active agent material; differential sedimentation or creaming of active agent particles and suspending particles; solution mediated transformation of active agent material; and loss of active  
25 agent to the surfaces of the container closure system, in particular the metering valve components. Such qualities work to achieve and preserve aerosol performance as the formulation is delivered from an MDI such that desirable fine particle fraction, fine particle dose, and delivered dose uniformity characteristics are achieved and substantially maintained throughout emptying of an MDI canister within which the  
30 formulation is contained. Additionally, compositions according to the present description can provide a stable formulation that provides consistent dosing

characteristics, even for potent and highly potent active agents, while using a relatively simple HFO suspension medium that does not require modification by the addition of, for example, cosolvents, antisolvents, solubilizing agents, or adjuvants. Moreover, in specific embodiments, the pharmaceutical compositions described herein can be  
5 formulated with an HFO propellant or propellant system substantially free of antisolvents, solubilizing agents, cosolvents, or adjuvants.

In some embodiments, compositions formulated according to the present teachings inhibit physical and/or chemical degradation of the active agents included therein. For example, in specific embodiments, the compositions described herein may  
10 inhibit one or more of chemical degradation, flocculation, aggregation, and solution mediated transformation of the active agents included in the compositions. The chemical and suspension stability provided by the compositions described herein provides for enhanced robustness in simulated use testing (SUT) as compared to conventional preparations. Simulated use testing includes storage of an MDI canister  
15 for five weeks at 25 °C and 75% relative humidity (RH), with no weekly cleaning of the device, and dispensing of the composition from the MDI at 25 °C and 50% RH. Enhanced robustness can take the form of consistency of shot weight (i.e., the weight of the composition dispensed upon activation of the MDI), low levels of propellant leakage, and desirable delivered dose uniformity throughout emptying of an MDI  
20 canister (“DDU”), even where the active agents to be delivered are highly potent and delivered at very low doses. For example, in some embodiments the compositions described herein exhibit less than about 10%, less than about 9%, less than about 8%, less than about 7%, less than about 6%, or less than about 5% reduced shot weight when delivered by MDI in SUT. In further embodiments, the compositions described  
25 herein exhibit less than about 1.0%, less than about 0.5%, less than about 0.4%, less than about 0.3%, less than about 0.2%, or less than about 0.1% weight loss in the MDI per year at 20 °C and 60% RH. In still further embodiments, the compositions described herein exhibit a DDU of  $\pm 20\%$  or better,  $\pm 15\%$  or better, or  $\pm 10\%$  or better, throughout emptying of the MDI canister. Moreover, compositions according to the  
30 present description exhibit enhance robustness by substantially preserving FPF and FPD performance throughout emptying of an MDI canister, even after being subjected to

accelerated degradation conditions. For example, in some embodiments, the compositions described herein are dispensed from an MDI at a FPF that is maintained within about 85% or within about 95% of the initial FPF. Compositions described herein provide the added benefit of achieving such performance while being formulated using HFO propellants. In specific embodiments, the compositions described herein achieve one or more of a targeted DDU, FPF, or FPD, while being formulated with suspension medium including only one or more HFO propellants and without the need to modify the characteristics of the propellant, such as by the addition of, for example, one or more cosolvent, antisolvent, solubilizing agent, adjuvant, or other propellant modifying material.

#### *Suspension Medium*

The suspension medium included in a composition described herein includes one or more propellants. In general, suitable propellants for use as suspension mediums are those propellant gases that can be liquefied under pressure at room temperature, and upon inhalation or topical use, are safe and toxicologically innocuous. Additionally, it is desirable that the selected propellant be relatively non-reactive with the suspending particles or active agent particles. In the past, compositions for delivery by MDIs were typically formulated using chlorofluorocarbon (CFC) propellants, hydrofluoroalkanes (HFAs), or perfluorinated compounds (PFCs). Propellants comprising hydrofluoroolefins (HFOs) are considered more environmentally friendly, but several barriers existed to the use of HFOs in MDI formulations given the marked difference between HFOs and other propellants. For example, 1,1,1,2-tetrafluoroethane (also known as norflurane, HFA-134a or HFC-134a) is widely used in industrial, consumer, and pharmaceutical products as refrigerant or propellant, however, it has been demonstrated that HFOs cannot be used as a drop-in replacement of HFA-134a due to the thermodynamic differences between HFOs and HFA-134a. Also, HFOs for industrial or consumer use are not in compliance with the good manufacturing practice (GMP) regulations and are not considered to be safe for patient use. In addition, the performance of a pMDI is highly dependent on the propellant because the propellant properties impact on the suspension stability, suspension atomization, aerosol droplet

diameter, etc. For example, a recent study has shown that the same suspending particles have lower suspension stability in HFO-1234ze compared to HFA-134a and HFA-227ea (Wang, H., et al., Respiratory Drug Delivery, Lisbon, Portugal, 2019). Thus, extensive experimentation would be needed to identify a formulation that would deliver the desired doses of active agent particles with desirable DDU and consistent 5 FPF values. As shown in Table A below, the physiochemical properties vary widely among different propellants.

**Table A.** Propellant Properties:

Propellant	HFA-134a	HFA-227ea	HFC-152a	HFO-1234ze	HFO-1234yf
Chemical Formula	C <sub>2</sub> H <sub>2</sub> F <sub>4</sub>	C <sub>3</sub> HF <sub>7</sub>	C <sub>2</sub> H <sub>4</sub> F <sub>2</sub>	C <sub>3</sub> H <sub>2</sub> F <sub>4</sub>	C <sub>3</sub> H <sub>2</sub> F <sub>4</sub>
Molecular Weight (g/mol)	102	170	66	114	114
Liquid Density @ 20°C (g/mL)	1.23	1.41	0.91	1.18	1.11
Dipole Moment (Debye)	2.06	1.46	2.30	1.44	2.54
Surface Tension @ 20°C (mN/m)	8.09	7.50	10.4	8.9	6.8
Boiling Point (°C)	-26.1	-16.5	-24.7	-19.0	-29.5
Liquid Viscosity @ 20°C (mPa·S)	0.211	0.267	0.171	0.206 <sup>3</sup>	0.164
Vapor Pressure @ 20°C (kPa)	570	390	510	427	592
Water Solubility in Propellant (ppm)	1100@25	610@25	2100@25	225@20	200@24
Latent Heat @ 25°C (kJ/kg)	177.7	110.97	279.1	166.8	145.4
Latent Heat @ Boiling Point (kJ/kg)	216.7	131.4	318.4	195.43	180.5

10

Surprisingly, it was found that for compositions comprising active agent particles and suspending particles as described herein, MDI formulations comprising

HFO propellants are suitable for use as inhalant medicine, despite the fact that HFOs and other propellants, e.g., HFAs, have significantly different structures and properties.

In some embodiments, the HFO propellant is 1,3,3,3-tetrafluoropropene, also referred to as HFO-1234ze. HFO-1234ze has a trans form ((1E)-1,3,3,3-tetrafluoropropene, also referred to as HFO-1234ze(E)) and a cis form ((1Z)-1,3,3,3-tetrafluoropropene, also referred to as HFO-1234ze(Z)). In some embodiments, the HFO propellant is HFO-1234ze(E), also known as *trans*-1,3,3,3-Tetrafluoroprop-1-ene. In some embodiments, the propellant is a pharmaceutical grade HFO, such as pharmaceutical grade HFO-1234ze(E). The term “pharmaceutical grade propellant,” as used herein, indicates a propellant that is in compliance with the GMP regulations for use in humans. For example, the pharmaceutical grade propellant is consistent with the major health authorities’ guidelines, such as FDA’s or EMA’s Guideline on The Pharmaceutical Quality of Inhalation and Nasal Products, and its specification as an excipient has been established to ensure the quality and safety of the propellant, e.g., HFO-1234ze(E), for pharmaceutical product use. The specification tests include propellant identity, appearance, assay, acidity, total residue, moisture content, related impurities, and unrelated impurities. Stability studies are also in progress to demonstrate long-term physicochemical stability. In some embodiments, the pharmaceutical grade HFO-1234ze(E) has a purity of at least about 99.90%. In some embodiments, the propellant is pharmaceutical grade HFO-1234ze(E) having a purity of at least about 99.90%, at least about 99.91%, at least about 99.92%, at least about 99.93%, at least about 99.94%, at least about 99.95%. Pharmaceutical grade HFO-1234ze(E) is suitable for use as a propellant due to both its overall purity and the absence or low concentration of specific impurities. In some embodiments, the pharmaceutical grade HFO-1234ze(E) contains about 10 ppm or less, about 9 ppm or less, about 8 ppm or less, about 7 ppm or less, about 6 ppm or less, or about 5 ppm or less of any one of the following impurities: HFO-1234yf, HFO-1234ze(Z), HFC-125, CFC-11, HFC-245cb, HFO-1225ye(Z) or HFO-1225ye(E), CFC-113, and CFC-114. In some embodiments, the pharmaceutical grade HFO-1234ze(E) contains about 10 ppm or less, about 9 ppm or less, about 8 ppm or less, about 7 ppm or less, about 6 ppm or less, or about 5 ppm or less of HFO-1234yf. In some embodiments, the pharmaceutical

grade HFO-1234ze(E) contains about 10 ppm or less, about 9 ppm or less, about 8 ppm or less, about 7 ppm or less, about 6 ppm or less, or about 5 ppm or less of HFO-1234ze(Z). In some embodiments, the pharmaceutical grade HFO-1234ze(E) contains about 10 ppm or less, about 9 ppm or less, about 8 ppm or less, about 7 ppm or less, about 6 ppm or less, or about 5 ppm or less of HFC-125. In some embodiments, the pharmaceutical grade HFO-1234ze(E) contains about 10 ppm or less, about 9 ppm or less, about 8 ppm or less, about 7 ppm or less, about 6 ppm or less, or about 5 ppm or less of CFC-111. In some embodiments, the pharmaceutical grade HFO-1234ze(E) contains about 10 ppm or less, about 9 ppm or less, about 8 ppm or less, about 7 ppm or less, about 6 ppm or less, or about 5 ppm or less of HFC-245cb. In some embodiments, the pharmaceutical grade HFO-1234ze(E) contains about 10 ppm or less, about 9 ppm or less, about 8 ppm or less, about 7 ppm or less, about 6 ppm or less, or about 5 ppm or less of HFO-1225ye(Z). In some embodiments, the pharmaceutical grade HFO-1234ze(E) contains about 10 ppm or less, about 9 ppm or less, about 8 ppm or less, about 7 ppm or less, about 6 ppm or less, or about 5 ppm or less of HFO-1225ye(E). In some embodiments, the pharmaceutical grade HFO-1234ze(E) contains about 10 ppm or less, about 9 ppm or less, about 8 ppm or less, about 7 ppm or less, about 6 ppm or less, or about 5 ppm or less of CFC-113. In some embodiments, the pharmaceutical grade HFO-1234ze(E) contains about 10 ppm or less, about 9 ppm or less, about 8 ppm or less, about 7 ppm or less, about 6 ppm or less, or about 5 ppm or less of CFC-114. In some embodiments, the pharmaceutical grade HFO-1243ze(E) contains about 150 ppm or less, about 140 ppm or less, about 130 ppm or less, about 120 ppm or less, about 110 ppm or less, or about 100 ppm or less of HCFC-124. In some embodiments, the pharmaceutical grade HFO-1234ze(E) contains about 400 ppm or less, about 375 ppm or less, about 350 ppm or less, about 325 ppm or less, or about 300 ppm or less of HFC-152a.

In some embodiments, the suspension medium may be formed of a single propellant, e.g., the pharmaceutical grade HFO-1234ze(E). In certain embodiments, certain vapor pressure compounds are present in a relatively low level. Such compounds may be associated with the suspending particles.

In some embodiments, the suspension medium may be formed of a propellant or propellant system that is substantially free of additional materials, including, for example, antisolvents, solubilizing agents, stabilizing agents, cosolvents, or adjuvants.

5 In some embodiments, the present pharmaceutical composition, which comprises a propellant of pharmaceutical grade HFO-1234ze(E); a plurality of active agent particles; and a plurality of phospholipid particles, exhibits similar or comparable bioavailability of the active agent(s) compared to a reference pharmaceutical composition, which comprises a propellant of pharmaceutical grade HFA-134a; a  
10 plurality of active agent particles; and a plurality of phospholipid particles. As used herein, a “reference pharmaceutical composition” means an alternative pharmaceutical composition which contains the same active agent particles and the same suspending particles as the present pharmaceutical composition except the propellant. For example, the present pharmaceutical composition and the reference pharmaceutical composition  
15 comprise the same active agent particles and the same phospholipids particles, but the reference pharmaceutical composition comprises a propellant of pharmaceutical grade HFA-134a, while the present pharmaceutical composition comprises a propellant of pharmaceutical grade HFO-1234ze(E). HFA-134a is a hydrofluorocarbon with the chemical name: 1,1,1,2-tetrafluoroethane. HFA-134a has been used as a propellant in  
20 metered dose inhalers. As used herein, “bioavailability” means the proportion of an active agent which enters the circulation when introduced into the body through the lungs. In one embodiment, similar or comparable bioavailability can be shown, wherein a ratio of the geometric mean of logarithmic transformed C<sub>max</sub>, AUC<sub>inf</sub> or AUC<sub>last</sub> for the two products (e.g., the present pharmaceutical composition and the  
25 reference pharmaceutical composition) is about 0.80 to about 1.25 with or without the 90% confidence interval (CI) limits.

In some embodiments, the present pharmaceutical composition exhibits C<sub>max</sub>, AUC<sub>inf</sub> or AUC<sub>last</sub> of any one or more of the active agents, which is about 80% to about 125% of C<sub>max</sub>, AUC<sub>inf</sub> or AUC<sub>last</sub> of the one or more of the active agents of  
30 a reference pharmaceutical composition with geometric means. In some embodiments, the present pharmaceutical composition comprises a propellant of pharmaceutical grade

HFO-1234ze(E); a plurality of active agent particles; and a plurality of phospholipid particles comprising perforated microstructures, while the reference pharmaceutical composition comprises a propellant of pharmaceutical grade HFA-134a; a plurality of active agent particles; and a plurality of phospholipid particles comprising perforated microstructures. In some embodiments, the present pharmaceutical composition and the reference pharmaceutical composition are both administered by actuating metered dose inhalers, wherein each actuation of the present pharmaceutical composition provides the same delivered dose of the active agent(s) as each actuation of the reference pharmaceutical composition does. In some embodiments, the active agent particles comprise an active agent selected from a long-acting muscarinic antagonist (LAMA), a long-acting  $\beta$ 2-agonists (LABA), a short-acting beta-agonists (SABA), an inhaled corticosteroid (ICS), and a non-corticosteroid anti-inflammatory agent as described herein.

As used herein,  $C_{max}$ ,  $AUC_{inf}$  and  $AUC_{last}$  are pharmacokinetic measures used to determine active agent dosing. As used herein,  $C_{max}$  means the highest concentration of an active agent in the blood after a dose is administered, e.g., via inhalation. As used herein, the area under the curve (AUC) is the definite integral of a curve that describes the variation of an active agent concentration in blood plasma as a function of time. As used herein,  $AUC_{inf}$  means area under the curve from the time of dosing to the last measurable concentration and extrapolated to infinity. As used herein,  $AUC_{last}$  means area under the curve from the time of dosing to the last measurable concentration.

In some embodiments, the present pharmaceutical composition exhibits  $C_{max}$  of budesonide, which is about 80% to about 125% of  $C_{max}$  of budesonide of a reference pharmaceutical composition. In some embodiments, the present pharmaceutical composition exhibits  $C_{max}$  of glycopyrrolate, which is about 80% to about 125% of  $C_{max}$  of glycopyrrolate of a reference pharmaceutical composition. In some embodiments, the present pharmaceutical composition exhibits  $C_{max}$  of formoterol, which is about 80% to about 125% of  $C_{max}$  of formoterol of a reference pharmaceutical composition. In some embodiment,  $C_{max}$  of budesonide is the geometric mean of logarithmic transformed value. In some embodiments, the present

pharmaceutical composition comprises a combination of budesonide and formoterol active agent particles. In some embodiments, the present pharmaceutical composition comprises a combination of budesonide and albuterol active agent particles. In some embodiments, the present pharmaceutical composition comprises a combination of glycopyrrolate and formoterol active agent particles. In some embodiments, the present pharmaceutical composition comprises a combination of budesonide, glycopyrrolate and formoterol active agent particles. In some embodiments, the present pharmaceutical composition comprises a combination of budesonide, glycopyrrolate, formoterol and roflumilast active agent particles.

10 In some embodiments, the present pharmaceutical composition exhibits AUC<sub>inf</sub> of budesonide, which is about 80% to about 125% of AUC<sub>inf</sub> of budesonide of a reference pharmaceutical composition. In some embodiments, the present pharmaceutical composition exhibits AUC<sub>inf</sub> of formoterol, which is about 80% to about 125% of AUC<sub>inf</sub> of formoterol of a reference pharmaceutical composition. In some embodiment, AUC<sub>inf</sub> of budesonide is the geometric mean of logarithmic transformed value. In some embodiments, the present pharmaceutical composition comprises a combination of budesonide and formoterol active agent particles. In some embodiments, the present pharmaceutical composition comprises a combination of budesonide and albuterol active agent particles. In some embodiments, the present pharmaceutical composition comprises a combination of glycopyrrolate and formoterol active agent particles. In some embodiments, the present pharmaceutical composition comprises a combination of budesonide, glycopyrrolate and formoterol active agent particles. In some embodiments, the present pharmaceutical composition comprises a combination of budesonide, glycopyrrolate, formoterol and roflumilast active agent particles.

In some embodiments, the present pharmaceutical composition exhibits AUCl<sub>ast</sub> of budesonide, which is about 80% to about 125% of AUCl<sub>ast</sub> of budesonide of a reference pharmaceutical composition. In some embodiments, the present pharmaceutical composition exhibits AUCl<sub>ast</sub> of glycopyrrolate, which is about 80% to about 125% of AUCl<sub>ast</sub> of glycopyrrolate of a reference pharmaceutical composition. In some embodiments, the present pharmaceutical composition exhibits AUCl<sub>ast</sub> of

formoterol, which is about 80% to about 125% of AUClast of formoterol of a reference pharmaceutical composition. In some embodiments, the present pharmaceutical composition exhibits AUClast of budesonide and formoterol, which is about 80% to about 125% of AUClast of budesonide and formoterol of a reference pharmaceutical composition. In some embodiment, AUClast of budesonide is the geometric mean of logarithmic transformed value. In some embodiments, the present pharmaceutical composition comprises a combination of budesonide and formoterol active agent particles. In some embodiments, the present pharmaceutical composition comprises a combination of budesonide and albuterol active agent particles. In some embodiments, the present pharmaceutical composition comprises a combination of glycopyrrolate and formoterol active agent particles. In some embodiments, the present pharmaceutical composition comprises a combination of budesonide, glycopyrrolate and formoterol active agent particles. In some embodiments, the present pharmaceutical composition comprises a combination of budesonide, glycopyrrolate, formoterol and roflumilast active agent particles.

#### *Active Agent Particles*

The active agent particles included in the compositions described herein are formed of a material capable of being dispersed and suspended within the suspension medium and are sized to facilitate delivery of respirable particles from the composition. In one embodiment, therefore, the active agent particles are provided as micronized particles wherein at least 90% of the active agent particles by volume exhibit an optical diameter of about 7  $\mu\text{m}$  or less. In some embodiments, at least 90% of the active agent particles by volume exhibit an optical diameter of about 5  $\mu\text{m}$  or less. In other embodiments, at least 90% of the active agent particles by volume exhibit an optical diameter selected from a range of about 7  $\mu\text{m}$  to about 1  $\mu\text{m}$ , about 5  $\mu\text{m}$  to about 2  $\mu\text{m}$ , and about 3  $\mu\text{m}$  to about 2  $\mu\text{m}$ . In further embodiments, at least 90% of the active agent particles by volume exhibit an optical diameter selected from 6  $\mu\text{m}$  or less, 5  $\mu\text{m}$  or less, 4  $\mu\text{m}$  or less, or 3  $\mu\text{m}$  or less. In another embodiment, the active agent particles are provided as micronized particles wherein at least 50% of the active agent particles by volume exhibit an optical diameter of about 4  $\mu\text{m}$  or less. In further

embodiments, the active agent particles are provided as micronized particles wherein at least 50% of the active agent particles by volume exhibit an optical diameter selected from about 3  $\mu\text{m}$  or less, about 2  $\mu\text{m}$  or less, about 1.5  $\mu\text{m}$  or less, and about 1  $\mu\text{m}$  or less. In still further embodiments, the active agent particles are provided as micronized particles wherein at least 50% of the active agent particles by volume exhibit an optical diameter selected from a range of about 4  $\mu\text{m}$  to about 1  $\mu\text{m}$ , about 3  $\mu\text{m}$  to about 1  $\mu\text{m}$ , about 2  $\mu\text{m}$  to about 1  $\mu\text{m}$ , about 1.3  $\mu\text{m}$ , and about 1.9  $\mu\text{m}$ .

In certain embodiments, the active agent particles comprise glycopyrrolate and at least 90% of the active agent particles by volume exhibit an optical diameter of about 7  $\mu\text{m}$  or less. In certain embodiments, the active agent particles comprise budesonide and at least 90% of the active agent particles by volume exhibit an optical diameter of about 7  $\mu\text{m}$  or less. In certain embodiments, the active agent particles comprise formoterol and at least 90% of the active agent particles by volume exhibit an optical diameter of about 5  $\mu\text{m}$  or less. In certain embodiments, the active agent particles comprise albuterol and at least 90% of the active agent particles by volume exhibit an optical diameter of about 5  $\mu\text{m}$  or less.

The active agent particles may be formed entirely of active agent or they may be formulated to include one or more active agents in combination with one or more excipients or adjuvants. In specific embodiments, an active agent present in the active agent particles may be entirely or substantially crystalline. In another embodiment, the active agent particles may include an active agent present in both crystal and amorphous states. In yet another embodiment, the active agent particles may include an active agent present in both crystal and amorphous states. In yet a further embodiment, where two or more active agents are present in active agent particles, at least one such active agent may be present in crystalline or substantially crystalline form and at least another active agent may be present in an amorphous state. In still another embodiment, where two or more active agents are present in active agent particles, each such active agent may be present in crystalline or substantially crystalline form. Where the active agent particles described herein include one or more active agents in combination with one or more excipients or adjuvants, the excipients and adjuvants can be selected based on the chemical and physical properties of the

active agent used. Suitable excipients for formulation of active agent particles include, for example, lipid, phospholipids, carbohydrates, amino acids, organic salts, peptides, proteins, alditols, synthetic or natural polymers, or surfactant materials.

Any suitable process may be employed to achieve micronized active agent particles for inclusion in the compositions described herein. A variety of processes may be used to create active agent particles suitable for use in the formulations described herein, including, but not limited to, micronization by milling or grinding processes, crystallization or recrystallization processes, processes using precipitation from supercritical or near-supercritical solvents, spray drying, spray freeze drying, or lyophilization. Patent references teaching suitable methods for obtaining micronized active agent particles include, for example, U.S. Patent No. 6,063,138, U.S. Patent No. 5,858,410, U.S. Patent No. 5,851,453, U.S. Patent No. 5,833,891, U.S. Patent No. 5,707,634, and International Patent Publication No. WO 2007/009164. Where the active agent particles include active agent material formulated with one or more excipient or adjuvant, micronized active agent particles can be formed using one or more of the preceding processes and such processes can be used to achieve active agent particles having a desired size distribution and particle configuration.

The active agent particles may be provided in any suitable concentration within the suspension medium. The active agent included in the active agent particles is substantially insoluble in the suspension medium. In some embodiments, the active agent, despite being substantially insoluble, exhibits measurable solubility in the suspension medium. However, even where the active agent exhibits measurable solubility in the suspension medium, the compositions described herein work to preserve the physical stability of such active agents. In particular, in specific embodiments, an active agent included in the compositions described herein may exhibit sufficient solubility in the suspension medium such that as much as 5% of the total active agent mass dissolves in the suspension medium. Alternatively, the solubility of an active agent may result in dissolution of as much as 1% of the total active agent mass in the suspension medium. In another embodiment, the solubility of an active agent may result in dissolution of as much as 0.5% of the total active agent mass in the suspension medium. In yet another embodiment, the solubility of an active

agent may result in dissolution of as much as 0.05% of the total active agent mass in the suspension medium. In still another embodiment, the solubility of an active agent may result in dissolution of as much as 0.025% of the total active agent mass in the suspension medium.

5                   A variety of therapeutic or prophylactic agents can be incorporated into the co-suspension compositions disclosed herein. Exemplary active agents include those that may be administered in the form of aerosolized medicaments, and active agents suitable for use in the compositions described herein include those that may be presented in a form or formulated in a manner which is dispersible within the selected  
10 suspension medium (e.g., is substantially insoluble or exhibits a solubility in the suspension medium that substantially maintains a co-suspension formulation), is capable of forming a co-suspension with the suspending particles, and is subject to respirable uptake in physiologically effective amounts. The active agents that may be utilized in forming the active agent particles described herein can have a variety of  
15 biological activities.

                  Examples of specific active agents that may be included in a composition according to the present description may for example, short-acting beta agonists (SABA), e.g., bitolterol, carbuterol, fenoterol, hexoprenaline, isoprenaline (isoproterenol), levosalbutamol, orciprenaline (metaproterenol), pirbuterol, procaterol,  
20 rimiterol, salbutamol (albuterol), terbutaline, tulobuterol, reproterol, ipratropium and epinephrine; long-acting  $\beta_2$  adrenergic receptor agonist (“LABA”), e.g., bambuterol, clenbuterol, formoterol, and salmeterol; ultra long-acting  $\beta_2$  adrenergic receptor agonists, e.g., carmoterol, milveterol, indacaterol, and saligenin- or indole-containing and adamantyl-derived  $\beta_2$  agonists; corticosteroids, e.g., beclomethasone, budesonide,  
25 ciclesonide, flunisolide, fluticasone, methyl-prednisolone, mometasone, prednisone and triamcinolone; anti-inflammatories, e.g. fluticasone propionate, beclomethasone dipropionate, flunisolide, budesonide, tripedane, cortisone, prednisone, prednisilone, dexamethasone, betamethasone, or triamcinolone acetonide; antitussives, e.g., noscapine; bronchodilators, e.g., ephedrine, adrenaline, fenoterol, formoterol,  
30 isoprenaline, metaproterenol, salbutamol, albuterol, salmeterol, terbutaline; and muscarinic antagonists, including long-acting muscarinic antagonists (“LAMA”), e.g.,

glycopyrrolate, dexpirronium, scopolamine, tropicamide, pirenzepine, dimenhydrinate, tiotropium, darotropium, acclidinium, trospium, ipatropium, atropine, benztropin, or oxitropium.

Where appropriate, the active agents provided in the composition, including but not limited to those specifically described herein, may be used in the form of salts (e.g., alkali metal or amine salts or as acid addition salts) or as esters, solvates (e.g., hydrates), derivatives, or a free base thereof. Additionally, the active agents may be in any crystalline form or isomeric form or mixture of isomeric forms, for example, as pure enantiomers, a mixture of enantiomers, as racemates or as mixtures thereof. In this regard, the form of the active agents may be selected to optimize the activity and/or stability of the active agent and/or to minimize the solubility of the active agent in the suspension medium.

Because the compositions disclosed enable the reproducible delivery of very low doses of active agents, in certain embodiments, the active agent included in the compositions described herein may be selected from one or more potent or highly potent active agents. For example, in certain embodiments, the compositions described herein may include one or more potent active agents that are to be delivered at a dose selected from between about 100  $\mu\text{g}$  and about 100 mg, about 100  $\mu\text{g}$  and about 10 mg, and about 100  $\mu\text{g}$  and 1 mg per actuation of an MDI. In other embodiments, the compositions described herein may include one or more potent or highly potent active agents that are to be delivered at a dose selected from up to about 80  $\mu\text{g}$ , up to about 40  $\mu\text{g}$ , up to about 20  $\mu\text{g}$ , between about 10  $\mu\text{g}$  and about 100  $\mu\text{g}$ , between about 5  $\mu\text{g}$  and about 50  $\mu\text{g}$ , and between about 1  $\mu\text{g}$  and about 10  $\mu\text{g}$  per actuation of an MDI. Additionally, in certain embodiments, the compositions described herein may include one or more highly potent active agents that are to be delivered at a dose selected from between about 0.1 and about 2  $\mu\text{g}$ , about 0.1 and about 1  $\mu\text{g}$ , and about 0.1 and about 0.5  $\mu\text{g}$  per actuation of an MDI.

A composition as described herein may, if desired, contain a combination of two or more active agents. For example, a combination of two or more species of active agent particles may be co-suspended with a single species of suspending particles. Alternatively, a composition may include two or more species of

active agent particles co-suspended with two or more different species of suspending particles. Even further, a composition as described herein may include two or more active agents combined within a single species of active agent particle. For example, where the active agent particles are formulated using one or more excipients or  
5 adjuvants in addition to the active agent material, such active agent particles may include individual particles that include two or more different active agents.

In certain embodiments, the active agent included in the compositions described herein is a LAMA active agent. Where the compositions include a LAMA active agent, in particular embodiments, the LAMA active agent may be selected from,  
10 for example, glycopyrrolate, dexpirronium, tiotropium, trospium, aclidinium, umeclidinium, and darotroprum, including any pharmaceutically acceptable salts, esters, isomers or solvates thereof. In some embodiments, a LAMA active agent is present at a concentration in the range of about 0.04 mg/mL to about 2.25 mg/mL.

Glycopyrrolate can be used to treat inflammatory or obstructive  
15 pulmonary diseases and disorders such as, for example, those described herein. As an anticholinergic, glycopyrrolate acts as a bronchodilator and provides an antisecretory effect, which is a benefit for use in the therapy of pulmonary diseases and disorders characterized by increased mucus secretions. Glycopyrrolate is a quaternary ammonium salt. Where appropriate, glycopyrrolate may be used in the form of salts (e.g., alkali  
20 metal or amine salts, or as acid addition salts) or as esters or as solvates (hydrates). Additionally, the glycopyrrolate may be in any crystalline form or isomeric form or mixture of isomeric forms, for example a pure enantiomer, a mixture of enantiomers, a racemate or a mixture thereof. In this regard, the form of glycopyrrolate may be selected to optimize the activity and/or stability of glycopyrrolate and/or to minimize  
25 the solubility of glycopyrrolate in the suspension medium. Suitable counter ions are pharmaceutically acceptable counter ions including, for example, fluoride, chloride, bromide, iodide, nitrate, sulfate, phosphate, formate, acetate, trifluoroacetate, propionate, butyrate, lactate, citrate, tartrate, malate, maleate, succinate, benzoate, p-chlorobenzoate, diphenyl-acetate or triphenylacetate, o-hydroxybenzoate, p-  
30 hydroxybenzoate, 1-hydroxynaphthalene-2-carboxylate, 3-hydroxynaphthalene-2-carboxylate, methanesulfonate and benzenesulfonate. In particular embodiments of the

compositions described herein, the bromide salt of glycopyrrolate, namely 3-[(cyclopentyl-hydroxyphenylacetyl)oxy]-1,1-dimethylpyrrolidinium bromide, also referred to as (RS)-[3-(SR)-Hydroxy-1,1-dimethylpyrrolidinium bromide] $\alpha$ -cyclopentylmandelate, is used and can be prepared according to the procedures set out  
5 in U.S. Pat. No. 2,956,062.

Where the compositions described herein include glycopyrrolate, in certain embodiments, the compositions may include sufficient glycopyrrolate to provide a target delivered dose selected from between about 1  $\mu$ g and about 200  $\mu$ g per actuation of an MDI, about 5  $\mu$ g and about 150  $\mu$ g per actuation of an MDI, about 10  $\mu$ g  
10 and 100  $\mu$ g per actuation of an MDI, about 5  $\mu$ g and about 50  $\mu$ g per actuation of an MDI, between about 2  $\mu$ g and about 25  $\mu$ g per actuation of an MDI, and between about 6  $\mu$ g and about 15  $\mu$ g per actuation of an MDI. In other such embodiments, the formulations include sufficient glycopyrrolate to provide a dose selected from up to about 200  $\mu$ g, up to about 150  $\mu$ g, up to about 75  $\mu$ g, up to about 40  $\mu$ g, up to about 20  
15  $\mu$ g, or up to about 10  $\mu$ g per actuation. In yet further embodiments, the formulations include sufficient glycopyrrolate to provide a dose selected from about 2  $\mu$ g per actuation, about 5  $\mu$ g per actuation, about 7  $\mu$ g per actuation, about 9  $\mu$ g per actuation, about 18  $\mu$ g per actuation, 36  $\mu$ g per actuation or about 72  $\mu$ g per actuation. In order to achieve targeted delivered doses as described herein, where compositions described  
20 herein include glycopyrrolate as the active agent, in specific embodiments, the amount of glycopyrrolate included in the compositions may be selected from, for example, between about 0.04 mg/mL and about 2.25 mg/mL.

In other embodiments, tiotropium, including any pharmaceutically acceptable salts, esters, isomers or solvates thereof, may be selected as a LAMA active  
25 agent for inclusion in a composition as described herein. Tiotropium is a known, long-acting anticholinergic drug suitable for use in treating diseases or disorders associated with pulmonary inflammation or obstruction, such as those described herein.

Tiotropium, including crystal and pharmaceutically acceptable salt forms of tiotropium, is described, for example, in U.S. Pat. No. 5,610,163, U.S. Pat. No. RE39,820, U.S. Pat.  
30 No. 6,777,423, and U.S. Pat. No. 6,908,928. Where the compositions described herein include tiotropium, in certain embodiments, the compositions may include sufficient

tiotropium to provide a delivered dose selected from between about 2.5  $\mu\text{g}$  and about 50  $\mu\text{g}$ , about 4  $\mu\text{g}$  and about 25  $\mu\text{g}$  per actuation, and about 2.5  $\mu\text{g}$  and about 20  $\mu\text{g}$ , about 10  $\mu\text{g}$  and about 20  $\mu\text{g}$ , and about 2.5  $\mu\text{g}$  and about 10  $\mu\text{g}$  per actuation of an MDI. In other such embodiments, the formulations include sufficient tiotropium to provide a delivered dose selected from up to about 50  $\mu\text{g}$ , up to about 20  $\mu\text{g}$ , up to about 10  $\mu\text{g}$ , up to about 5  $\mu\text{g}$ , or up to about 2.5  $\mu\text{g}$  per actuation of an MDI. In yet further embodiments, the formulations include sufficient tiotropium to provide a delivered dose selected from about 3  $\mu\text{g}$ , 6  $\mu\text{g}$ , 9  $\mu\text{g}$ , 18  $\mu\text{g}$ , and 36  $\mu\text{g}$  per actuation of the MDI. In order to achieve delivered doses as described herein, where compositions described herein include tiotropium as the active agent, in specific embodiments, the amount of tiotropium included in the compositions may be selected from, for example, between about 0.01 mg/mL and about 0.5 mg/mL.

In certain embodiments, the compositions described herein include a LABA active agent. In such embodiments, a LABA active agent can be selected from, for example, bambuterol, clenbuterol, formoterol, salmeterol, carmoterol, milveterol, indacaterol, vilanterol, and saligenin- or indole-containing and adamantyl-derived  $\beta_2$  agonists, and any pharmaceutically acceptable salts, esters, isomers or solvates thereof. In some embodiments a LABA active agent is present at a concentration in the range of about 0.01 mg/mL to about 1 mg/mL.

In certain such embodiments, formoterol is selected as the LABA active agent. Formoterol can be used to treat inflammatory or obstructive pulmonary diseases and disorders such as, for example, those described herein. Formoterol has the chemical name  $(\pm)$ -2-hydroxy-5-[(1RS)-1-hydroxy-2-[[[(1RS)-2-(4-methoxyphenyl)-1-methylethyl]-amino]ethyl]formanilide, and is commonly used in pharmaceutical compositions as the racemic fumarate dihydrate salt. Where appropriate, formoterol may be used in the form of salts (e.g. alkali metal or amine salts or as acid addition salts) or as esters or as solvates (hydrates). Additionally, the formoterol may be in any crystalline form or isomeric form or mixture of isomeric forms, for example a pure enantiomer, a mixture of enantiomers, a racemate or a mixture thereof. In this regard, the form of formoterol may be selected to optimize the activity and/or stability of formoterol and/or to minimize the solubility of formoterol in the suspension medium.

Pharmaceutically acceptable salts of formoterol include, for example, salts of inorganic acids such as hydrochloric, hydrobromic, sulfuric and phosphoric acids, and organic acids such as fumaric, maleic, acetic, lactic, citric, tartaric, ascorbic, succinic, glutaric, gluconic, tricarballic, oleic, benzoic, p-methoxybenzoic, salicylic, o- and p-  
5 hydroxybenzoic, p-chlorobenzoic, methanesulfonic, p-toluenesulfonic and 3-hydroxy-2-naphthalene carboxylic acids. Hydrates of formoterol are described, for example, in U.S. Pat. No. 3,994,974 and U.S. Pat. No. 5,684,199. Specific crystalline forms of formoterol and other  $\beta_2$  adrenergic receptor agonists are described, for example, in WO95/05805, and specific isomers of formoterol are described in U.S. Pat. No.  
10 6,040,344.

In specific embodiments, the formoterol material utilized to form the formoterol particles is formoterol fumarate, and in one such embodiment, the formoterol fumarate is present in the dihydrate form. Formoterol fumarate may be referred to by the chemical name N-[2-Hydroxy-5-[(1RS)-1-hydroxy-2-[[[(1RS)-2-(4-  
15 methoxyphenyl)-1-methylethyl]-amino]ethyl]phenyl]formamide (E)-2-butenedioate dehydrate. Where the compositions described herein include formoterol, in certain embodiments, the compositions described herein may include formoterol at a concentration that achieves a targeted delivered dose selected from between about 1  $\mu\text{g}$  and about 30  $\mu\text{g}$ , about 0.5  $\mu\text{g}$  and about 10  $\mu\text{g}$ , about 1  $\mu\text{g}$  and about 10  $\mu\text{g}$ , about 2  $\mu\text{g}$   
20 and 5  $\mu\text{g}$ , about 2  $\mu\text{g}$  and about 10  $\mu\text{g}$ , about 3  $\mu\text{g}$  and about 10  $\mu\text{g}$ , about 5  $\mu\text{g}$  and about 10  $\mu\text{g}$ , and 3  $\mu\text{g}$  and about 30  $\mu\text{g}$  per actuation of an MDI. In other embodiments, the compositions described herein may include formoterol in an amount sufficient to provide a targeted delivered dose selected from up to about 30  $\mu\text{g}$ , up to about 10  $\mu\text{g}$ , up to about 5  $\mu\text{g}$ , up to about 2.5  $\mu\text{g}$ , up to about 2  $\mu\text{g}$ , or up to about 1.5  $\mu\text{g}$  per actuation.  
25 In yet further embodiments, the formulations include sufficient formoterol to provide a dose selected from about 2  $\mu\text{g}$  per actuation, about 4.5  $\mu\text{g}$  per actuation, about 4.8  $\mu\text{g}$  per actuation, about 5  $\mu\text{g}$  per actuation, about 10  $\mu\text{g}$  per actuation, about 20  $\mu\text{g}$  per actuation, or about 30  $\mu\text{g}$  per actuation. In order to achieve targeted delivered doses as described herein, where compositions described herein include formoterol as the active  
30 agent, in specific embodiments, the amount of formoterol included in the compositions may be selected from, for example, between about 0.01 mg/mL and about 1 mg/mL,

between about 0.01 mg/mL and about 0.5 mg/mL, and between about 0.03 mg/mL and about 0.4 mg/mL.

Where the pharmaceutical compositions described herein include a LABA active agent, in certain embodiments, the active agent may be salmeterol, including any pharmaceutically acceptable salts, esters, isomers or solvates thereof. Salmeterol can be used to treat inflammatory or obstructive pulmonary diseases and disorders such as, for example, those described herein. Salmeterol, pharmaceutically acceptable salts of salmeterol, and methods for producing the same are described, for example, in U.S. Pat. No. 4,992,474, U.S. Pat. No. 5,126,375, and U.S. Pat. No. 5,225,445.

Where salmeterol is included as a LABA active agent, in certain embodiments, the compositions described herein may include salmeterol at a concentration that achieves a delivered dose selected from between about 2 µg and about 120 µg, about 4 µg and about 40 µg, about 8 µg and 20 µg, about 8 µg and about 40 µg, about 20 µg and about 40 µg, and about 12 µg and about 120 µg per actuation of an MDI. In other embodiments, the compositions described herein may include salmeterol in an amount sufficient to provide a delivered dose selected from up to about 120 µg, up to about 40 µg, up to about 20 µg, up to about 10 µg, up to about 8 µg, or up to about 6 µg per actuation of an MDI. In order to achieve targeted delivered doses as described herein, where compositions described herein include salmeterol as the active agent, in specific embodiments, the amount of salmeterol included in the compositions may be selected from, for example, between about 0.04 mg/mL and about 4 mg/mL, between about 0.04 mg/mL and about 2.0 mg/mL, and between about 0.12 mg/mL and about 0.8 mg/mL.

Where the pharmaceutical compositions described herein include a SABA active agent, in certain embodiments, the active agent may be bitolterol, carbuterol, fenoterol, hexoprenaline, isoprenaline (isoproterenol), levosalbutamol, orciprenaline (metaproterenol), pirbuterol, procaterol, rimiterol, albuterol (salbutamol), terbutaline, tulobuterol, reproterol, and epinephrine, including any pharmaceutically acceptable salts, esters, isomers, or solvates thereof. In certain such embodiments, albuterol is selected as the SABA active agent. Albuterol has the chemical name  $\alpha^1$ -

[(tert-butylamino)methyl]4-hydroxy-m-xylene- $\alpha,\alpha'$ -diol and has an empirical formula of  $C_{13}H_{21}NO_3$ . Albuterol can be used to treat inflammatory or obstructive pulmonary diseases and disorders such as, for example, those described herein. Albuterol, pharmaceutically acceptable salts of albuterol (such as albuterol sulfate), and methods  
5 for producing the same are described, for example, in U.S. Pat. No. 3,705,233.

Where albuterol is included as a SABA active agent, in certain embodiments, the compositions described herein may include albuterol at a concentration that achieves a delivered dose selected from between about 10  $\mu\text{g}$  and about 200  $\mu\text{g}$ , about 20  $\mu\text{g}$  and about 300  $\mu\text{g}$ , about 30  $\mu\text{g}$  and 150  $\mu\text{g}$ , about 50  $\mu\text{g}$  and  
10 about 200  $\mu\text{g}$ , about 30  $\mu\text{g}$  and about 100  $\mu\text{g}$ , and about 1  $\mu\text{g}$  and about 300  $\mu\text{g}$  per actuation of an MDI. In other embodiments, the compositions described herein may include albuterol in an amount sufficient to provide a delivered dose selected from up to about 300  $\mu\text{g}$ , up to about 200  $\mu\text{g}$ , up to about 150  $\mu\text{g}$ , up to about 100  $\mu\text{g}$ , up to about 50  $\mu\text{g}$ , up to about 30  $\mu\text{g}$ , up to about 20  $\mu\text{g}$ , or up to about 10  $\mu\text{g}$  per actuation of an  
15 MDI. In yet further embodiments, the formulations include sufficient albuterol to provide a dose selected from about 20  $\mu\text{g}$ , about 30  $\mu\text{g}$ , about 40  $\mu\text{g}$ , about 50  $\mu\text{g}$ , about 60  $\mu\text{g}$ , about 70  $\mu\text{g}$ , about 80  $\mu\text{g}$ , about 90  $\mu\text{g}$ , about 100  $\mu\text{g}$ , about 110  $\mu\text{g}$ , about 120  $\mu\text{g}$ , about 130  $\mu\text{g}$ , about 140  $\mu\text{g}$ , or about 150  $\mu\text{g}$  per actuation. In order to achieve targeted delivered doses as described herein, where compositions described herein  
20 include albuterol as the active agent, in specific embodiments, the amount of albuterol included in the compositions may be selected from, for example, between about 0.1 mg/mL and about 10 mg/mL, between about 0.1 mg/mL and about 5 mg/mL, and between about 0.3 mg/mL and about 4 mg/mL.

In still other embodiments, the compositions described herein include a  
25 corticosteroid, such as an inhaled corticosteroid (ICS). Such active agents may be selected from, for example, beclomethasone, budesonide, ciclesonide, flunisolide, fluticasone, methylprednisolone, mometasone, prednisone and triamcinolone, and any pharmaceutically acceptable salts, esters, isomers or solvates thereof. In some embodiments, an ICS active agent is present at a concentration in the range of about 0.1  
30 mg/mL to about 10 mg/mL.

Where the compositions include an ICS active agent, in particular embodiments, mometasone may be selected. Mometasone, pharmaceutically acceptable salts of mometasone, such as mometasone furoate, and preparation of such materials are known and described, for example, in U.S. Pat. No. 4,472,393, U.S. Pat. No. 5,886,200, and U.S. Pat. No. 6,177,560. Mometasone is suitable for use in treating diseases or disorders associated with pulmonary inflammation or obstruction, such as those described herein (see, e.g., U.S. Pat. No. 5,889,015, U.S. Pat. No. 6,057,307, U.S. Pat. No. 6,057,581, U.S. Pat. No. 6,677,322, U.S. Pat. No. 6,677,323 and U.S. Pat. No. 6,365,581).

Where the compositions described herein include mometasone, in particular embodiments, the compositions include mometasone, including any pharmaceutically acceptable salts, esters, isomers or solvates thereof, in an amount sufficient to provide a target delivered dose selected from between about 20 µg and about 400 µg, about 20 µg and about 200 µg, about 50 µg and about 200 µg, about 100 µg and about 200 µg, about 20 µg and about 100 µg, and about 50 µg and about 100 µg per actuation of an MDI. In still other embodiments, the compositions described herein may include mometasone, including any pharmaceutically acceptable salts, esters, isomers or solvates thereof, in an amount sufficient to provide a targeted delivered dose selected from up to about 400 µg, up to about 200 µg, or up to about 100 µg per actuation of an MDI.

In other embodiments, the compositions described herein include a corticosteroid selected from fluticasone and budesonide. Both fluticasone and budesonide are suitable for use in treatment of conditions associated with pulmonary inflammation or obstruction, such as those described herein. Fluticasone, pharmaceutically acceptable salts of fluticasone, such as fluticasone propionate, and preparation of such materials are known, and described, for example, in U.S. Pat. No. 4,335,121, U.S. Pat. No. 4,187,301, and U.S. Pat. Pub. No. US2008125407. Budesonide, which has the chemical name (RS)-11β, 16α, 17, 21-Tetrahydroxypregna-1,4-diene-3,20-dione cyclic 16,17-acetal with butyraldehyde, is also well known and described, for example, in U.S. Pat. No. 3,929,768. In certain embodiments, compositions described herein may include fluticasone, including any pharmaceutically

acceptable salts, esters, isomers or solvates thereof, in an amount sufficient to provide a target delivered dose selected from between about 20 µg and about 200 µg, about 50 µg and about 175 µg, and between about 80 µg and about 160 µg per actuation of an MDI. In other embodiments, the compositions described herein may include fluticasone, including any pharmaceutically acceptable salts, esters, isomers or solvates thereof, in an amount sufficient to provide a targeted delivered dose selected from up to about 175 µg, up to about 160 µg, up to about 100 µg, or up to about 80 µg per actuation of an MDI. Where the compositions described herein include budesonide, in certain embodiments, the compositions described herein may include budesonide, including any pharmaceutically acceptable salts, esters, isomers or solvates thereof, at a concentration that achieves a targeted delivered dose selected from between about 30 µg and about 240 µg, about 30 µg and about 120 µg, between about 30 µg and about 100 µg, between about 50 µg and about 400 µg, between about 20 µg and about 600 µg, between about 50 µg and about 200 µg, between about 150 µg and about 350 µg, and between about 30 µg and about 50 µg per actuation of an MDI. In other embodiments, the compositions described herein may include budesonide, including any pharmaceutically acceptable salts, esters, isomers or solvates thereof, in an amount sufficient to provide a targeted delivered dose selected from up to about 240 µg, up to about 160 µg, up to about 120 µg, up to about 80 µg, or up to about 50 µg per actuation of an MDI. In yet further embodiments, the formulations include sufficient budesonide to provide a dose selected from about 20 µg per actuation, about 40 µg per actuation, about 80 µg per actuation, about 100 µg per actuation, about 160 µg per actuation, about 200 µg per actuation, or about 300 µg per actuation. In order to achieve targeted delivered doses as described herein, where compositions described herein include budesonide as the active agent, in specific embodiments, the amount of budesonide included in the compositions may be selected from, for example, between about 0.1 mg/mL and about 20 mg/mL, between about 0.1 mg/mL and about 5 mg/mL, and between about 0.3 mg/mL and about 6 mg/mL.

In yet further embodiments, the compositions described herein include a non-corticosteroid anti-inflammatory agent, such as a phosphodiesterase-4 (PDE-4) inhibitor and a Janus kinase (JAK) inhibitor. Such anti-inflammatory agents may be

selected from, for example, roflumilast, apremilast, crisaborole, ruxolitinib, tofacitinib, oclacitinib, baricitinib, peficitinib, fedratinib, and upadacitinib; or any pharmaceutically acceptable salts, esters, isomers or solvates thereof. Roflumilast, pharmaceutically acceptable salts of roflumilast, and preparation of such materials are known and  
5 described, for example, in U.S. Pat. No. 8,604,064, U.S. Pat. No. 9,145,365, and U.S. Pat. No. 9,321,726. Roflumilast is suitable for use in treating diseases or disorders associated with pulmonary inflammation or obstruction, such as those described herein. Roflumilast is sometimes used for the treatment of COPD, particularly severe COPD, and is available as an oral medication. Gastrointestinal side effects are common with  
10 oral administration of roflumilast.

Where the compositions described herein include roflumilast, in certain embodiments, the compositions described herein may include roflumilast, including any pharmaceutically acceptable salts, esters, isomers or solvates thereof, at a concentration that achieves a targeted delivered dose selected from between about 1  $\mu\text{g}$  and about 100  
15  $\mu\text{g}$ , about 5  $\mu\text{g}$  and about 80  $\mu\text{g}$ , about 5  $\mu\text{g}$  and about 50  $\mu\text{g}$ , about 5  $\mu\text{g}$  and about 25  $\mu\text{g}$ , about 10  $\mu\text{g}$  and 25  $\mu\text{g}$ , about 30  $\mu\text{g}$  and about 240  $\mu\text{g}$ , about 30  $\mu\text{g}$  and about 120  $\mu\text{g}$ , between about 30  $\mu\text{g}$  and about 100  $\mu\text{g}$ , between about 50  $\mu\text{g}$  and about 400  $\mu\text{g}$ , between about 20  $\mu\text{g}$  and about 600  $\mu\text{g}$ , between about 50  $\mu\text{g}$  and about 200  $\mu\text{g}$ , between about 150  $\mu\text{g}$  and about 350  $\mu\text{g}$ , and between about 30  $\mu\text{g}$  and about 50  $\mu\text{g}$  per  
20 actuation of an MDI. In other embodiments, the compositions described herein may include roflumilast, including any pharmaceutically acceptable salts, esters, isomers or solvates thereof, in an amount sufficient to provide a targeted delivered dose selected from up to about 240  $\mu\text{g}$ , up to about 160  $\mu\text{g}$ , up to about 120  $\mu\text{g}$ , up to about 80  $\mu\text{g}$ , or up to about 50  $\mu\text{g}$  per actuation of an MDI. In yet further embodiments, the  
25 formulations include sufficient roflumilast to provide a dose selected from about 20  $\mu\text{g}$  per actuation, about 40  $\mu\text{g}$  per actuation, about 80  $\mu\text{g}$  per actuation, about 100  $\mu\text{g}$  per actuation, about 160  $\mu\text{g}$  per actuation, about 200  $\mu\text{g}$  per actuation, or about 300  $\mu\text{g}$  per actuation. In order to achieve targeted delivered doses as described herein, where compositions described herein include roflumilast as the active agent, in specific  
30 embodiments, the amount of roflumilast included in the compositions may be selected

from, for example, between about 0.1 mg/mL and about 20 mg/mL, between about 0.1 mg/mL and about 5 mg/mL, and between about 0.3 mg/mL and about 6 mg/mL.

The compositions described herein can be formulated to include (and deliver) a single active agent. Alternatively, the compositions described herein may include two or more active agents. In particular embodiments, where two or more active agents are included, the compositions described herein may include a combination of active agents selected from a combination of a LAMA and LABA active agents, a combination of LAMA and corticosteroid active agents, a combination of LAMA and SABA active agents, a combination of LAMA and non-corticosteroid anti-inflammatory active agents, a combination of LABA and SABA active agents, a combination of LABA and non-corticosteroid anti-inflammatory active agents, a combination of SABA and corticosteroid active agents, a combination of SABA and non-corticosteroid anti-inflammatory active agents, and a combination of LABA and corticosteroid active agents. In other embodiments, the compositions described herein may include three or more active agents. In certain such embodiments, the composition includes a combination of active agents selected from a combination of a LAMA, LABA, corticosteroid, and non-corticosteroid anti-inflammatory active agents. For example, a composition as described herein may include a combination of active agents selected from a combination of glycopyrrolate and formoterol, a combination of formoterol and budesonide, a combination of budesonide and albuterol, a combination of glycopyrrolate, formoterol, and budesonide and a combination of glycopyrrolate, formoterol, budesonide, and roflumilast.

With the aid of the present disclosure, it will be appreciated by those having skill in the art that a wide variety of active agents may be incorporated into the suspensions disclosed herein. The above list of active agents is by way of example and not limitation.

### *Suspending Particles*

The suspending particles included in the compositions described herein work to facilitate stabilization and delivery of the active agent included in the compositions. Though various forms of suspending particles may be used, the

suspending particles are typically formed from pharmacologically inert material that is acceptable for inhalation and is substantially insoluble in the propellant selected.

Generally, the majority of suspending particles are sized within a respirable range. In particular embodiments, therefore, the MMAD of the suspending particles will not  
5 exceed about 10  $\mu\text{m}$  but is not lower than about 500 nm. In an alternative embodiment, the MMAD of the suspending particles is between about 5  $\mu\text{m}$  and about 750 nm. In yet another embodiment, the MMAD of the suspending particles is between about 1  $\mu\text{m}$  and about 3  $\mu\text{m}$ . When used in an embodiment for nasal delivery from an MDI, the MMAD of the suspending particles is between 10  $\mu\text{m}$  and 50  $\mu\text{m}$ .

10 In order to achieve respirable suspending particles within the MMAD ranges described, the suspending particles will typically exhibit a volume median optical diameter between about 0.2  $\mu\text{m}$  and about 50  $\mu\text{m}$ . In one embodiment, the suspending particles exhibit a volume median optical diameter that does not exceed about 25  $\mu\text{m}$ . In another embodiment, the suspending particles exhibit a volume  
15 median optical diameter selected from between about 0.5  $\mu\text{m}$  and about 15  $\mu\text{m}$ , between about 1.5  $\mu\text{m}$  and about 10  $\mu\text{m}$ , and between about 2  $\mu\text{m}$  and about 5  $\mu\text{m}$ .

The concentration of suspending particles included in a composition according to the present description can be adjusted, depending on, for example, the amount of active agent particles and suspension medium used. In one embodiment, the  
20 suspending particles are included in the suspension medium at a concentration selected from about 0.1 mg/mL to about 15 mg/mL, about 0.1 mg/mL to about 10 mg/mL, 1 mg/mL to about 15 mg/mL, about 3 mg/mL to about 10 mg/mL, 5 mg/mL to about 8 mg/mL, and about 6 mg/mL. In another embodiment, the suspending particles are included in the suspension medium at a concentration of up to about 30 mg/mL. In yet  
25 another embodiment, the suspending particles are included in the suspension medium at a concentration of up to about 25 mg/mL.

The relative amount of suspending particles to active agent particles is selected to achieve a co-suspension as contemplated herein. A co-suspension composition may be achieved where the amount of suspending particles, as measured  
30 by mass, exceeds that of the active agent particles. For example, in specific embodiments, the ratio of the total mass of the suspending particles to the total mass of

active agent particles may be between about 3:1 and about 15:1, or alternatively from about 2:1 and 8:1. Alternatively, the ratio of the total mass of the suspending particles to the total mass of active agent particles may be above about 1, such as up to about 1.5, up to about 5, up to about 10, up to about 15, up to about 17, up to about 20, up to about 5 30, up to about 40, up to about 50, up to about 60, up to about 75, up to about 100, up to about 150, and up to about 200, depending on the nature of the suspending particles and active agent particles used. In further embodiments, the ratio of the total mass of the suspending particles to the total mass of the active agent particles may be selected from between about 10 and about 200, between about 60 and about 200, between about 15 10 and about 60, between about 15 and about 170, between about 15 and about 60, about 16, about 60, and about 170.

In other embodiments, the amount of suspending particles, as measured by mass, is less than that of the active agent particles. For example, in particular embodiments, the mass of the suspending particles may be as low as 20% of the total 15 mass of the active agent particles. However, in some embodiments, the total mass of the suspending particles may also approximate or equal the total mass of the active agent particles.

Suspending particles suitable for use in the compositions described herein may be formed of one or more pharmaceutically acceptable materials or 20 excipients that are suitable for inhaled delivery and do not substantially degrade or dissolve in the suspension medium. In one embodiment, perforated microstructures, as defined herein, may be used as the suspending particles. Suspending particles and perforated microstructures for use as suspending particles, and methods for preparation thereof, are described in U.S. Patent No. 8,815,258 and U.S. Patent No. 9,463,161, and 25 in U.S. Patent Application Publication 2011/0135737.

Phospholipids from both natural and synthetic sources may be used in preparing suspending particles comprising perforated microstructures suitable for use in the compositions described herein. In particular embodiments, the phospholipid chosen will have a gel to liquid crystal phase transition of greater than about 400°C. 30 Exemplary phospholipids are relatively long chain (i.e., C16-C22) saturated lipids and may comprise saturated phospholipids, such as saturated phosphatidylcholines having

acyl chain lengths of 16 C or 18 C (palmitoyl and stearoyl). Exemplary phospholipids include phosphoglycerides such as dipalmitoylphosphatidylcholine, distearylphosphatidylcholine, diarachidoylphosphatidylcholine, dibehenoylphosphatidylcholine, diphosphatidyl glycerol, short-chain  
5 phosphatidylcholines, long-chain saturated phosphatidylethanolamines, long-chain saturated phosphatidylserines, long-chain saturated phosphatidylglycerols, and long-chain saturated phosphatidylinositols. Additional excipients are disclosed in International Patent Publication No. WO 96/32149 and U.S. Patent Nos. 6,358,530, 6,372,258 and 6,518,239. In certain embodiments, the suspending particles are  
10 phospholipid particles comprising 1,2-Distearyl-sn-glycero-3-phosphocholine (DSPC).

In another aspect, the suspending particles utilized in the compositions described herein may be selected to increase storage stability of the selected active agent, similar to that disclosed in International Patent Publication No. WO  
2005/000267. For example, in one embodiment, the suspending particles may include  
15 pharmaceutically acceptable glass stabilization excipients having a Tg of at least 55 °C, at least 75 °C, or at least 100 °C. Glass formers suitable for use in compositions described herein include, but are not limited to, one or more of trileucine, sodium citrate, sodium phosphate, ascorbic acid, inulin, cyclodextrin, polyvinyl pyrrolidone, mannitol, sucrose, trehalose, lactose, and, proline. Examples of additional glass-  
20 forming excipients are disclosed in U. S. Patent Nos. RE 37,872, 5,928,469, 6,258,341, and 6,309,671. In particular embodiments, suspending particles may include a calcium salt, such as calcium chloride, as described, for example, in U.S. Patent No. 7,442,388.

In certain embodiments, the suspending particles are perforated microstructures comprising DSPC and calcium chloride. In some embodiments, the  
25 perforated microstructures comprise about 93% or more of DSPC and about 7% or less of calcium chloride. In some embodiments, the perforated microstructures comprise about 94% of DSPC and about 6% of calcium chloride. In some embodiments, the perforated microstructures comprise about 95% of DSPC and about 5% of calcium chloride.

30 The suspending particles may be designed, sized and shaped as desired to provide desirable stability and active agent delivery characteristics. In one

exemplary embodiment, the suspending particles comprise perforated microstructures as described herein. Where perforated microstructures are used as suspending particles in the compositions described herein, they may include at least one of the following: lipids, phospholipids, nonionic detergents, nonionic block copolymers, ionic  
5 surfactants, biocompatible fluorinated surfactants and combinations thereof, particularly those approved for pulmonary use. Specific surfactants that may be used in the preparation of perforated microstructures include poloxamer 188, poloxamer 407 and poloxamer 338. Other specific surfactants include oleic acid or its alkali salts. In one embodiment, the perforated microstructures include greater than about 10% w/w  
10 surfactant.

Furthermore, suspending particles as described herein may include bulking agents, such as polymeric particles. Polymeric polymers may be formed from biocompatible and/or biodegradable polymers, copolymers or blends. In one  
15 embodiment, polymers capable of forming aerodynamically light particles may be used, such as functionalized polyester graft copolymers and biodegradable polyanhydrides. For example, bulk eroding polymers based on polyesters including poly(hydroxy acids) can be used. Polyglycolic acid (PGA), polylactic acid (PLA) or copolymers thereof may be used to form suspending particles. The polyester may include a charged or  
20 functionalizable group, such as an amino acid. For example, suspending particles may be formed of poly(D,L-lactic acid) and/or poly(D,L-lactic-co-glycolic acid) (PLGA), which incorporate a surfactant such as DPPC.

Other potential polymer candidates for use in suspending particles may include polyamides, polycarbonates, polyalkylenes such as polyethylene,  
25 polypropylene, poly(ethylene glycol), poly(ethylene oxide), poly(ethylene terephthalate), polyvinyl compounds such as polyvinyl alcohols, polyvinyl ethers, and polyvinyl esters, polymers of acrylic and methacrylic acids, celluloses and other polysaccharides, and peptides or proteins, or copolymers or blends thereof. Polymers may be selected with or modified to have the appropriate stability and degradation rates in vivo for different controlled drug delivery applications.

30 In an embodiment of a composition as described herein that includes one or more of glycopyrrolate, formoterol, budesonide, and albuterol as an active agent, the

ratio of the total mass of the suspending particles to the total mass of the active agent particles may be selected from between about 1 and about 20, between about 1 and about 15, between about 1.5 and about 10, between about 2.5 and about 15, between about 2.5 and about 10, between about 2.5 and about 8, between about 10 and about 30, 5 between about 15 and about 25, between about 10 and about 200, between about 50 and about 125, and between about 5 and about 50.

In some embodiments, suspending particles may be prepared by forming an oil-in-water emulsion, using a fluorocarbon oil (e.g., perfluorooctyl bromide, perfluorodecalin) which may be emulsified using a surfactant such as a long chain 10 saturated phospholipid. The resulting perfluorocarbon in water emulsion may be then processed using a high pressure homogenizer to reduce the oil droplet size. The perfluorocarbon emulsion may be fed into a spray dryer. As is well known, spray drying is a one-step process that converts a liquid feed to a dried particulate form. Spray drying has been used to provide powdered pharmaceutical material for various 15 administrative routes, including inhalation. In the context of spray drying, a fluorocarbon oil such as described above may function as a blowing agent. Operating conditions of the spray dryer (such as inlet and outlet temperature, feed rate, atomization pressure, flow rate of the drying air and nozzle configuration) can be adjusted to produce the desired particle size producing a yield of the resulting dry 20 microstructures. Such methods of producing exemplary perforated microstructures are disclosed in U.S. Patent No. 8,815,258, U.S. Patent No. 9,463,161, and U.S. Patent Application Publication 2011/0135737,

The compositions described herein may include two or more species of suspending particles. For example, the compositions described herein may include a 25 single species of active agent particle and two or more species of suspending particles. Alternatively, in other embodiments, the compositions described herein may include two or more species of active agent particles combined with two or more species of suspending particles.

#### *Embodiments of Compositions*

30 In one embodiment, a composition described herein comprising a combination of two or more active agents may contain budenoside, glycopyrrolate, and

formoterol as active agents. In an embodiment of a composition as described herein, that includes budesonide, glycopyrrolate, and formoterol as active agents, the ratio of the total mass of the suspending particles to the total mass of the active agent particles may be selected from between about 1 and about 20, between about 1 and about 15, 5 between about 1.5 and about 10, between about 2.5 and about 15, between about 2.5 and about 10, between about 2.5 and about 8, between about 10 and about 30, between about 15 and about 25, between about 10 and about 200, between about 50 and about 125, and between about 5 and about 50. In all embodiments, the ratio of the active agents to the suspending particles is based on the free form (e.g., free acid or free base 10 form) of the active agents. In an embodiment, the composition is administered by oral inhalation. In a certain embodiment, the composition described herein that includes budesonide, glycopyrrolate, and formoterol, as active agents may be contained in a reservoir in a metered dose inhalation (MDI) device. In some embodiments, the composition described herein may include budesonide, including any pharmaceutically 15 acceptable salts, esters, isomers or solvates thereof, at a concentration that achieves a targeted delivered dose selected from between about 70  $\mu\text{g}$  to about 170  $\mu\text{g}$ , between about 75  $\mu\text{g}$  to about 165  $\mu\text{g}$ , and between about 80  $\mu\text{g}$  to about 160  $\mu\text{g}$ , of budesonide per inhalation. In some embodiments, the composition described herein may include glycopyrrolate, including any pharmaceutically acceptable salts, esters, isomers or 20 solvates thereof, at a concentration that achieves a targeted delivered dose selected from between about 5  $\mu\text{g}$  to about 10  $\mu\text{g}$ , and between about 5  $\mu\text{g}$  to about 15  $\mu\text{g}$  of glycopyrrolate per inhalation. In some embodiments, the composition described herein may include formoterol, including any pharmaceutically acceptable salts, esters, isomers or solvates thereof, at a concentration that achieves a targeted delivered dose 25 selected from between about 1  $\mu\text{g}$  to about 5  $\mu\text{g}$  and between about 2  $\mu\text{g}$  to about 4  $\mu\text{g}$  of formoterol per inhalation. In some embodiments, the composition may be administered as two inhalations per dose in two doses per day. In some embodiments, a composition described herein comprising about 0.240% to about 0.360% by weight (w/w) budesonide, about 0.010% to about 0.016% by weight (w/w) glycopyrronium 30 bromide, about 0.007% to about 0.011% by weight (w/w) formoterol fumarate, about 0.410% to about 0.615% by weight (w/w) DSPC porous particles, and HFO-1234ze(E).

In some embodiments, a composition described herein comprising about 0.268% to about 0.328% by weight (w/w) budesonide, about 0.012% to about 0.015% by weight (w/w) glycopyrronium bromide, about 0.008% to about 0.010% by weight (w/w) formoterol fumarate, about 0.461% to about 0.564% by weight (w/w) DSPC porous particles, and HFO-1234ze(E). In some embodiments, a composition described herein comprising about 0.283% to about 0.314% by weight (w/w) budesonide, about 0.013% to about 0.014% by weight (w/w) glycopyrronium bromide, about 0.008% to about 0.010% by weight (w/w) formoterol fumarate, about 0.487% to about 0.538% by weight (w/w) DSPC porous particles, and HFO-1234ze(E). Table 1 shows an exemplary embodiment of a composition comprising a combination of two or more active agents containing glycopyrrolate, formoterol, and budesonide as active agents. In one embodiment, the exemplary composition of Table 1 can provide a delivered dose of about 160  $\mu$ g budesonide, about 9  $\mu$ g glycopyrronium bromide and about 4.8  $\mu$ g formoterol fumarate per actuation of the metered dose inhaler.

15

**Table 1.** Budesonide, glycopyrronium bromide and formoterol fumarate pressurized inhalation suspension with HFO-1234ze(E) propellant

Components	Function	Amount (per canister)	Weight %
Budesonide, micronized	API	31.05 mg	0.2986
Glycopyrronium bromide, micronized	API	1.40 mg	0.0134
Formoterol fumarate, micronized	API	0.93 mg	0.0090
Porous particles of DSPC	Suspending particles	53.30 mg	0.5125
HFO-1234ze(E)	Propellant	10.31 g	99.1665

In one embodiment, a composition described herein comprising a combination of two or more active agents may contain glycopyrrolate and formoterol as active agents. In an embodiment of a composition as described herein, that includes, glycopyrrolate and formoterol as active agents, the ratio of the total mass of the suspending particles to the total mass of the active agent particles may be selected from between about 1 and about 25, between about 1 and about 20, between about 1.5 and about 10, between about 2.5 and about 15, between about 2.5 and about 10, between about 2.5 and about 8, between about 10 and about 30, between about 15 and about 25,

between about 10 and about 200, between about 50 and about 125, and between about 5 and about 50. In all embodiments, the ratio of the active agents to the suspending particles is based on the free base form of the active agents. In an embodiment, the composition is administered by oral inhalation. In a certain embodiment, the composition as described herein that includes glycopyrrolate and formoterol, as active agents may be contained in a reservoir in a metered dose inhalation (MDI) device. In some embodiments, the composition as described herein may include glycopyrrolate, including any pharmaceutically acceptable salts, esters, isomers or solvates thereof, at a concentration that achieves a targeted delivered dose selected from between about 5  $\mu\text{g}$  to about 10  $\mu\text{g}$ , and between about 5  $\mu\text{g}$  to about 15  $\mu\text{g}$  of glycopyrrolate per inhalation. In some embodiments, the composition as described herein may include formoterol, including any pharmaceutically acceptable salts, esters, isomers or solvates thereof, at a concentration that achieves a targeted delivered dose selected from between about 1  $\mu\text{g}$  to about 5  $\mu\text{g}$  of formoterol per inhalation. In some embodiments, the composition may be administered as two inhalations per dose in two doses per day. In some embodiments, a composition described herein comprising about 0.011% to about 0.016% by weight (w/w) glycopyrrolate, about 0.007% to about 0.011% by weight (w/w) formoterol fumarate, about 0.411% to about 0.617% by weight (w/w) DSPC porous particles, and HFO-1234ze(E). In some embodiments, a composition described herein comprising about 0.012% to about 0.015% by weight (w/w) glycopyrrolate, about 0.008% to about 0.010% by weight (w/w) formoterol fumarate, about 0.411% to about 0.617% by weight (w/w) DSPC porous particles, and HFO-1234ze(E). In some embodiments, a composition described herein comprising about 0.013% to about 0.014% by weight (w/w) glycopyrrolate, about 0.008% to about 0.010% by weight (w/w) formoterol fumarate, about 0.488% to about 0.540% by weight (w/w) DSPC porous particles, and HFO-1234ze(E). Table 2 shows an exemplary embodiment of a composition containing glycopyrrolate and formoterol as active agents. In one embodiment, the exemplary composition of Table 2 can provide a delivered dose of about 9  $\mu\text{g}$  glycopyrrolate and about 4.8  $\mu\text{g}$  formoterol fumarate per actuation of the metered dose inhaler.

**Table 2.** Glycopyrronium bromide and formoterol fumarate pressurized inhalation suspension with HFO-1234ze(E) propellant

Components	Function	Quantity (per canister)	Weight%
Glycopyrronium bromide, micronized	API	1.40 mg	0.0135
Formoterol Fumarate, micronized	API	0.93 mg	0.0090
Porous particles of DSPC	Suspending particles	53.30 mg	0.5142
HFO-1234ze(E)	Propellant	10.31 g	99.4633

In one embodiment, a composition described herein comprising a combination of two or more active agents may contain budesonide and albuterol sulfate as active agents. In an embodiment of a composition as described herein, that includes budesonide and albuterol sulfate as active agents, the ratio of the total mass of the suspending particles to the total mass of the active agent particles may be selected from between about 1 and about 25, between about 1 and about 20, between about 1.5 and about 10, between about 2.5 and about 15, between about 2.5 and about 10, between about 2.5 and about 8, between about 10 and about 30, between about 15 and about 25, between about 10 and about 200, between about 50 and about 125, and between about 5 and about 50. In all embodiments, the ratio of the active agents to the suspending particles is based on the free base form of the active agents. In an embodiment, the composition is administered by oral inhalation. In a certain embodiment, the composition as described herein that includes budesonide and albuterol sulfate, as active agents, may be contained in a reservoir in a metered dose inhalation (MDI) device. In some embodiments, the composition described herein may include budesonide, including any pharmaceutically acceptable salts, esters, isomers or solvates thereof, at a concentration that achieves a targeted delivered dose selected from between about 35 $\mu$ g to about 90  $\mu$ g, and between about 40  $\mu$ g to about 85  $\mu$ g, and between about 45  $\mu$ g to about 80  $\mu$ g of budesonide per inhalation. In some embodiments, the composition described herein may include albuterol sulfate, including any pharmaceutically acceptable salts, esters, isomers or solvates thereof, at a concentration that achieves a targeted delivered dose selected from between about 75 $\mu$ g to about 95  $\mu$ g and between 80  $\mu$ g to about 90  $\mu$ g of albuterol sulfate per inhalation. In

some embodiments, the composition may be administered as two inhalations per dose in two doses per day. In some embodiments, a composition described herein comprising about 0.058% to about 0.088% by weight (w/w) budesonide, about 0.131% to about 0.197% by weight (w/w) albuterol sulfate, about 0.267% to about 0.401% by weight (w/w) DSPC porous particles, and HFO-1234ze(E). In some embodiments, a composition described herein comprising about 0.065% to about 0.080% by weight (w/w) budesonide, about 0.147% to about 0.180% by weight (w/w) albuterol sulfate, about 0.301% to about 0.367% by weight (w/w) DSPC porous particles, and HFO-1234ze(E). In some embodiments, a composition described herein comprising about 0.069% to about 0.077% by weight (w/w) budesonide, about 0.156% to about 0.172% by weight (w/w) albuterol sulfate, about 0.317% to about 0.351% by weight (w/w) DSPC porous particles, and HFO-1234ze(E). In some embodiments, a composition described herein comprising about 0.116% to about 0.175% by weight (w/w) budesonide, about 0.131% to about 0.197% by weight (w/w) albuterol sulfate, about 0.266% to about 0.400% by weight (w/w) DSPC porous particles, and HFO-1234ze(E). In some embodiments, a composition described herein comprising about 0.131% to about 0.161% by weight (w/w) budesonide, about 0.147% to about 0.180% by weight (w/w) albuterol sulfate, about 0.300% to about 0.366% by weight (w/w) DSPC porous particles, and HFO-1234ze(E). In some embodiments, a composition described herein comprising about 0.138% to about 0.153% by weight (w/w) budesonide, about 0.156% to about 0.172% by weight (w/w) albuterol sulfate, about 0.316% to about 0.350% by weight (w/w) DSPC porous particles, and HFO-1234ze(E). Tables 3A and 3B show two exemplary embodiments of a composition containing budesonide and albuterol sulfate as active agents. In one embodiment, the exemplary composition of Table 3A can provide a delivered dose of about 40  $\mu$ g budesonide and about 90  $\mu$ g albuterol sulfate per actuation of the metered dose inhaler. In one embodiment, the exemplary composition of Table 3B can provide a delivered dose of about 80  $\mu$ g budesonide and about 90  $\mu$ g albuterol sulfate per actuation of the metered dose inhaler.

**Table 3A.** Budesonide and albuterol sulfate pressurized inhalation suspension with HFO-1234ze(E) propellant

Components	Function	Amount (per canister)	Weight%
------------	----------	--------------------------	---------

Budesonide, micronized	API	7.60 mg	0.073
Albuterol Sulfate, micronized	API	17.0 mg	0.164
Porous Particles of DSPC	Suspending particles	34.60 mg	0.334
HFO-1234ze(E)	Propellant	10.31 g	99.429

**Table 3B.** Budesonide and albuterol sulfate pressurized inhalation suspension with HFO-1234ze(E) propellant, 80/90  $\mu$ g per actuation

Components	Function	Amount (per canister)	Weight%
Budesonide, micronized	API	15.1 mg	0.146
Albuterol Sulfate, micronized	API	17.0 mg	0.164
Porous Particles of DSPC	Suspending particles	34.60 mg	0.333
HFO-1234ze(E)	Propellant	10.31 g	99.357

5 In one embodiment, a composition described herein comprising a combination of two or more active agents may contain budesonide and formoterol as active agents. In an embodiment of a composition as described herein, that includes budesonide and formoterol as active agents, the ratio of the total mass of the suspending particles to the total mass of the active agent particles may be selected from between about 1 and about 25, between about 1 and about 20, between about 1.5 and about 10, between about 2.5 and about 15, between about 2.5 and about 10, between about 2.5 and about 8, between about 10 and about 30, between about 15 and about 25, between about 10 and about 200, between about 50 and about 125, and between about 5 and about 50. In all 10 embodiments, the ratio of the active agents to the suspending particles is based on the free base form of the active agents. In an embodiment, the composition is administered by oral inhalation. In a certain embodiment, the composition as described herein that includes budesonide and formoterol, as active agents may be contained in a reservoir in 15 a metered dose inhalation (MDI) device. In some embodiments, the composition may

include budesonide, including any pharmaceutically acceptable salts, esters, isomers or solvates thereof, at a concentration that achieves a targeted delivered dose selected from between about 70  $\mu\text{g}$  to about 170  $\mu\text{g}$ , between about 75  $\mu\text{g}$  to about 165  $\mu\text{g}$ , and between about 80  $\mu\text{g}$  to about 160  $\mu\text{g}$ , of budesonide per inhalation. In some

5   embodiments, the composition may include formoterol, including any pharmaceutically acceptable salts, esters, isomers or solvates thereof, at a concentration that achieves a targeted delivered dose selected from between about 1  $\mu\text{g}$  to about 5  $\mu\text{g}$  and between about 2  $\mu\text{g}$  to about 4  $\mu\text{g}$  of formoterol per inhalation. In some embodiments, the composition may be administered as two inhalations per dose in two doses per day. In

10   some embodiments, a composition described herein comprising about 0.238% to about 0.358% by weight (w/w) budesonide, about 0.007% to about 0.011% by weight (w/w) formoterol fumarate, about 0.410% to about 0.615% by weight (w/w) DSPC porous particles, and HFO-1234ze(E). In some embodiments, a composition described herein comprising about 0.268% to about 0.329% by weight (w/w) budesonide, about 0.008%

15   to about 0.010% by weight (w/w) formoterol fumarate, about 0.461% to about 0.564% by weight (w/w) DSPC porous particles, and HFO-1234ze(E). In some embodiments, a composition described herein comprising about 0.283% to about 0.314% by weight (w/w) budesonide, about 0.008% to about 0.010% by weight (w/w) formoterol fumarate, about 0.487% to about 0.538% by weight (w/w) DSPC porous particles, and

20   HFO-1234ze(E). In some embodiments, a composition described herein comprising about 0.119% to about 0.180% by weight (w/w) budesonide, about 0.007% to about 0.011% by weight (w/w) formoterol fumarate, about 0.410% to about 0.616% by weight (w/w) DSPC porous particles, and HFO-1234ze(E). In some embodiments, a composition described herein comprising about 0.134% to about 0.165% by weight

25   (w/w) budesonide, about 0.008% to about 0.010% by weight (w/w) formoterol fumarate, about 0.462% to about 0.565% by weight (w/w) DSPC porous particles, and HFO-1234ze(E). In some embodiments, a composition described herein comprising about 0.142% to about 0.157% by weight (w/w) budesonide, about 0.008% to about 0.010% by weight (w/w) formoterol fumarate, about 0.487% to about 0.539% by

30   weight (w/w) DSPC porous particles, and HFO-1234ze(E). Tables 4A and 4B show two exemplary embodiments of a composition containing budesonide and formoterol as

active agents. In one embodiment, the exemplary composition of Table 4A can provide a delivered dose of about 160  $\mu\text{g}$  budesonide and about 4.8  $\mu\text{g}$  formoterol fumarate per actuation of the metered dose inhaler. In one embodiment, the exemplary composition of Table 4B can provide a delivered dose of about 80  $\mu\text{g}$  budesonide and about 4.8  $\mu\text{g}$  formoterol fumarate per actuation of the metered dose inhaler.

**Table 4A.** Budesonide and formoterol fumarate pressurized inhalation suspension with HFO-1234ze(E) propellant

Components	Function	Quantity (per canister)	% Weight
Budesonide, micronized	API	31.05	0.2987
Formoterol Fumarate, micronized	API	0.93 mg	0.0089
Porous Particles of DSPC	Suspending particles	53.30 mg	0.5127
HFO-1234ze(E)	Propellant	10.31 g	99.1797

10 **Table 4B.** Budesonide and formoterol fumarate pressurized inhalation suspension with HFO-1234ze(E) propellant

Components	Function	Quantity (per canister)	% Weight
Budesonide, micronized	API	15.525 mg	0.1496
Formoterol Fumarate, micronized	API	0.93 mg	0.0090
Porous Particles of DSPC	Suspending particles	53.30 mg	0.5135
HFO-1234ze(E)	Propellant	10.31 g	99.3279

In one embodiment, a composition described herein comprising a combination of two or more active agents may contain budesonide, glycopyrrolate, formoterol, and roflumilast as active agents. In an embodiment of a composition as described herein, that includes budesonide, glycopyrrolate, formoterol, and roflumilast as active agents, the ratio of the total mass of the suspending particles to the total mass of the active agent particles may be selected from between about 1 and about 20,

between about 1 and about 15, between about 1.5 and about 10, between about 2.5 and about 15, between about 2.5 and about 10, between about 2.5 and about 8, between about 10 and about 30, between about 15 and about 25, between about 10 and about 200, between about 50 and about 125, and between about 5 and about 50. In all

5 embodiments, the ratio of the active agents to the suspending particles is based on the free base form of the active agents. In some embodiments, the composition is administered by oral inhalation. In a certain embodiment, the composition described herein that includes budesonide, glycopyrrolate, formoterol, and roflumilast as active agents may be contained in a reservoir in a metered dose inhalation (MDI) device. In

10 some embodiments, the composition may include budesonide, including any pharmaceutically acceptable salts, esters, isomers or solvates thereof, at a concentration that achieves a targeted delivered dose selected from between about 70  $\mu\text{g}$  to about 170  $\mu\text{g}$ , between about 75  $\mu\text{g}$  to about 165  $\mu\text{g}$ , and between about 80  $\mu\text{g}$  to about 160  $\mu\text{g}$ , of budesonide per inhalation. In some embodiments, the composition described herein

15 may include glycopyrrolate, including any pharmaceutically acceptable salts, esters, isomers or solvates thereof, at a concentration that achieves a targeted delivered dose selected from between about 5  $\mu\text{g}$  to about 10  $\mu\text{g}$  and between about 5  $\mu\text{g}$  to about 15  $\mu\text{g}$  of glycopyrrolate per inhalation. In some embodiments, the composition described herein may include formoterol, including any pharmaceutically acceptable salts, esters,

20 isomers or solvates thereof, at a concentration that achieves a targeted delivered dose selected from between about 1  $\mu\text{g}$  to about 5  $\mu\text{g}$  and between about 2  $\mu\text{g}$  to about 4  $\mu\text{g}$  of formoterol per inhalation. In some embodiments, the composition described herein may include roflumilast, including any pharmaceutically acceptable salts, esters, isomers or solvates thereof, at a concentration that achieves a targeted delivered dose

25 selected from between about 1  $\mu\text{g}$  to about 25  $\mu\text{g}$ , between about 5  $\mu\text{g}$  to about 20  $\mu\text{g}$ , and between about 10  $\mu\text{g}$  to about 15  $\mu\text{g}$  of roflumilast per inhalation. In some embodiments, the composition may be administered as two inhalations per dose in two doses per day. In some embodiments, a composition described herein comprising about 0.024% to about 0.036% by weight (w/w) roflumilast, about 0.238% to about 0.358%

30 by weight (w/w) budesonide, about 0.010% to about 0.016% by weight (w/w) glycopyrronium bromide, about 0.007% to about 0.011% by weight (w/w) formoterol fumarate, about 0.410% to about 0.615% by weight (w/w) DSPC porous particles, and

HFO-1234ze(E). In some embodiments, a composition described herein comprising about 0.026% to about 0.033% by weight (w/w) roflumilast, about 0.268% to about 0.329% by weight (w/w) budesonide, about 0.012% to about 0.015% by weight (w/w) glycopyrronium bromide, about 0.008% to about 0.010% by weight (w/w) formoterol fumarate, about 0.461% to about 0.564% by weight (w/w) DSPC porous particles, and HFO-1234ze(E). In some embodiments, a composition described herein comprising about 0.028% to about 0.031% by weight (w/w) roflumilast, about 0.283% to about 0.314% by weight (w/w) budesonide, about 0.013% to about 0.014% by weight (w/w) glycopyrronium bromide, about 0.008% to about 0.010% by weight (w/w) formoterol fumarate, about 0.486% to about 0.538% by weight (w/w) DSPC porous particles, and HFO-1234ze(E). Table 5 shows an exemplary embodiment of a composition containing budesonide, glycopyrrolate, formoterol, and roflumilast as active agents.

**Table 5.** Budesonide, glycopyrronium bromide, formoterol fumarate and roflumilast pressurized inhalation suspension with HFO-1234ze(E) propellant

Components	Function	Quantity (per canister)	Weight%
Roflumilast, micronized	API	3.11 mg	0.0299
Budesonide, micronized	API	31.05 mg	0.2986
Glycopyrronium bromide, micronized	API	1.40 mg	0.0135
Formoterol Fumarate, micronized	API	0.93 mg	0.0089
Porous Particles of DSPC	Suspending particles	53.30 mg	0.5125
HFO-1234ze(E)	Propellant	10.31 g	99.1366

In one embodiment, a composition described herein comprising a combination of two or more active agents may contain umeclidinium bromide, vilanterol trifenate and fluticasone furoate as active agents. In another embodiment, a composition described herein comprising a combination of two or more active agents may contain umeclidinium bromide and vilanterol trifenate as active agents. In one

embodiment, a composition described herein comprising a combination of two or more active agents may contain glycopyrronium bromide, indacaterol acetate and mometasone furoate as active agents. In another embodiment, a composition described herein comprising a combination of two or more active agents may contain

5 glycopyrronium bromide and indacaterol acetate as active agents. In one embodiment, a composition described herein comprising a combination of two or more active agents may contain glycopyrronium bromide, formoterol and beclometasone dipropionate as active agents. Compositions formulated according to the present teachings can inhibit degradation of active agent included therein. For example, in specific embodiments,

10 the compositions described herein inhibit one or more of flocculation, aggregation and the solution mediated transformation of active agent material included in the compositions. The pharmaceutical compositions described herein are suited for respiratory delivery via an MDI in a manner that achieves desirable delivered dose uniformity ("DDU") of each active agent included in a combination of two or more

15 active agents, even with combinations including potent and highly potent actives. As is illustrated in detail in the Examples included herein, even when delivering very low doses of two or more active agents, compositions described herein can achieve a DDU of  $\pm 30\%$ , or better, for each active agent throughout emptying of an MDI canister. In one such embodiment, compositions described herein achieve a DDU of  $\pm 25\%$ , or

20 better, for each active agent throughout emptying of an MDI canister. In another such embodiment, compositions described herein achieve a DDU for the active agent of  $\pm 20\%$ , or better, for each active agent throughout emptying of an MDI canister. In further embodiments, compositions described herein achieve a DDU for the active agent of  $\pm 15\%$ , or better, for each active agent throughout emptying of an MDI canister.

25 In still further embodiments, compositions described herein achieve a DDU for the active agent of  $\pm 10\%$ , or better, for each active agent throughout emptying of an MDI canister.

Pharmaceutical compositions described herein also serve to substantially preserve FPF and FPD performance throughout emptying of an MDI canister, even

30 after being subjected to accelerated degradation conditions. For instance, compositions according to the present description maintain as much as 80%, 85%, 90%, 95%, or

more, of the original FPF and FPD performance throughout emptying of an MDI canister, even after being subjected to accelerated degradation conditions. Compositions described herein provide the added benefit of achieving such performance while being formulated using non-CFC and non-HFA propellants and eliminating or substantially  
5 avoiding combination effects often experienced with compositions incorporating multiple active agents. In specific embodiments, the compositions described herein achieve one or all of a targeted DDU, FPF and FPD performance while being formulated with suspension medium including only one or more HFO propellant and without the need to modify the characteristics of the HFO propellant, such as by the  
10 addition of, for example, one or more cosolvent, antisolvent, solubilizing agent, adjuvant or other propellant modifying material.

### *Methods*

Compositions formulated according to the present teachings can inhibit degradation of the active agent included therein. For example, in specific  
15 embodiments, the compositions described herein inhibit one or more of flocculation, aggregation and Ostwald ripening of the active agent(s) included in the compositions. The stability provided by the compositions described herein allows the compositions to be dispensed in a manner that achieves desirable delivered dose uniformity throughout emptying of an MDI canister ("DDU"), even where the active agent to be delivered is  
20 highly potent and the delivered dose of the active agent is selected from, for example, less than one of 100  $\mu\text{g}$ , 80  $\mu\text{g}$ , 40  $\mu\text{g}$ , 20  $\mu\text{g}$ , 10  $\mu\text{g}$ , 9  $\mu\text{g}$ , 8  $\mu\text{g}$ , 7  $\mu\text{g}$ , 6  $\mu\text{g}$ , 5  $\mu\text{g}$ , 4  $\mu\text{g}$ , 3  $\mu\text{g}$ , 2  $\mu\text{g}$ , 1  $\mu\text{g}$ , 0.5  $\mu\text{g}$ , and 0.1  $\mu\text{g}$  per actuation of the MDI. As is described in detail in the Examples included herein, even at low doses of highly potent active agents, compositions described herein can achieve a DDU of  $\pm 30\%$ , or better, for each of the  
25 active agents included in the composition. In an alternative embodiment, compositions described herein achieve a DDU of  $\pm 25\%$ , or better, for each of the active agents included in the composition. In yet further embodiments, compositions described herein achieve a DDU of  $\pm 20\%$ , or better,  $\pm 15\%$ , or better, or  $\pm 10\%$ , or better, for each of the active agents included in the composition.

Moreover, compositions according to the present description serve to substantially preserve FPF and FPD performance throughout emptying of an MDI canister, even after being subjected to accelerated degradation conditions. For instance, compositions according to the present description maintain as much as 80%, 85%, 90%, 5 95%, or more, of the original FPF and FPD performance, even when they incorporate multiple active agents. Compositions described herein provide the added benefit of achieving such performance while being formulated using non-CFC and non-HFA propellants. In specific embodiments, the compositions described herein achieve desired one or all of a targeted DDU, FPF and FPD performance while being 10 formulated with suspension medium including only one or more HFO propellant and without the need to modify the characteristics of the HFO propellant, such as by the addition of, for example, one or more cosolvent, antisolvent, solubilizing agent, adjuvant or other propellant modifying material.

The stability and physical characteristics of the compositions described 15 herein support several methods. For example, in one embodiment, a method of formulating a pharmaceutical composition for respiratory delivery of an active agent is provided herein. The method involves the steps of providing a suspension medium comprising an HFO propellant, one or more species of active agent particles and one or more species of suspending particles, as described herein, and combining such 20 constituents to form a composition wherein active agent particles associate with the suspending particles such that a co-suspension as described herein is formed. In one such embodiment, the association of the active agent particles and the suspending particles is such that they do not separate due to their different buoyancies in a propellant. As will be appreciated, a method of formulating a pharmaceutical 25 composition as described herein can include providing two or more species of active agent particles in combination with one or more species of suspending particles. Alternatively, the method may include providing two or more suspending particles in combination with one or more species of active agent particles.

In further embodiments the compositions described herein support, for 30 example, methods for forming stabilized formulations of active agents for pulmonary delivery, methods for preserving the FPF and/or FPD throughout emptying of an MDI

canister, methods for pulmonary delivery of potent or highly potent active agents, and methods of achieving a DDU selected from  $\pm 30\%$ , or better,  $\pm 25\%$ , or better,  $\pm 20\%$ , or better,  $\pm 15\%$ , or better, and  $\pm 10\%$ , or better, for potent and highly potent drugs administered through pulmonary delivery.

5                   In methods involving pulmonary delivery of active agents using compositions described herein, the compositions may be delivered by an MDI. Therefore, in particular embodiments of such methods, an MDI loaded with a composition described herein is obtained, and the desired active agent is administered to a patient through pulmonary delivery through actuation of the MDI. For example, in  
10 one embodiment, after shaking the MDI device, the mouthpiece is inserted into a patient's mouth between the lips and teeth. The patient typically exhales deeply to empty the lungs and then takes a slow deep breath while actuating the cartridge of the MDI. When actuated, the specified volume of formulation travels to the expansion chamber, out the actuator nozzle and into a high-velocity spray that is drawn into the  
15 lungs of a patient. In some embodiments the dose of active agent delivered throughout emptying of an MDI canister is not more than 20% greater than the mean delivered dose and is not less than 20% less than the mean delivered dose. In some embodiments, the dose of active agent delivered throughout emptying of an MDI canister is not more than 15% greater or less than the mean delivered dose. In some embodiments, the dose  
20 of active agent delivered throughout emptying of an MDI canister is not more than 10% greater or less than the mean delivered dose.

                  In specific embodiments of methods for providing a stabilized formulation of active agent for pulmonary delivery, the present disclosure provides methods for inhibiting solution mediated transformation of an active agent in a  
25 pharmaceutical formulation for pulmonary delivery. In one embodiment, a suspension medium as described herein, such as a suspension medium formed by an HFO propellant, is obtained. Suspending particles are also obtained or prepared as described herein. One or more species of active agent particles as described herein are also obtained, and the suspension medium, suspending particles and active agent particles  
30 are combined to form a co-suspension wherein the active agent particles associate with suspending particles within the continuous phase formed by the suspension medium.

When compared to the active agent contained in the same suspension medium in the absence of suspending particles, co-suspensions according to the present description have been found to exhibit a higher tolerance to solution mediated transformation and irreversible crystal aggregation, and thus can lead to improved stability and dosing  
5 uniformity, allowing the formulation of active agents that are somewhat physically unstable in the suspension medium alone.

In specific embodiments of methods for preserving the FPF and/or FPD provided by a pharmaceutical formulation for pulmonary delivery of a respirable co-suspension as described herein is provided which is capable of maintaining the FPD  
10 and/or the FPF to within  $\pm 20\%$ ,  $\pm 15\%$ ,  $\pm 10\%$ , or even  $\pm 5\%$  the initial FPD and/or FPF, respectively, throughout emptying of an MDI canister. Such performance can be achieved even after the co-suspension is subjected to accelerated degradation conditions. In one embodiment, a suspension medium as described herein, such as a suspension medium formed by an HFO propellant, is obtained. Suspending particles  
15 are also obtained or prepared as described herein. One or more species of active agent particles as described herein are also obtained, and the suspension medium, suspending particles and active agent particles are combined to form a co-suspension wherein the active agent particles associate with suspending particles within the suspension medium. Even after exposure of such composition to one or more temperature cycling  
20 events, the co-suspension maintains an FPD or FPF within  $\pm 20\%$ ,  $\pm 15\%$ ,  $\pm 10\%$ , or even  $\pm 5\%$  of the respective values measured prior to exposure of the composition to the one or more temperature cycling events.

Methods for treating patients suffering from an inflammatory or obstructive pulmonary disease or condition are provided herein. In specific  
25 embodiments, such methods include pulmonary delivery of a therapeutically effective amount of a pharmaceutical composition described herein, and in certain such embodiments, pulmonary administration of the pharmaceutical composition is accomplished by delivering the composition using an MDI. In certain embodiments, the compositions, methods and systems described herein can be used to treat patients  
30 suffering from a disease or disorder selected from asthma, chronic obstructive pulmonary disease (COPD), exacerbation of airways hyper reactivity consequent to

other drug therapy, allergic rhinitis, sinusitis, pulmonary vasoconstriction, inflammation, allergies, impeded respiration, respiratory distress syndrome, pulmonary hypertension, pulmonary vasoconstriction, and any other respiratory disease, condition, trait, genotype or phenotype that can respond to the administration of, for example, a

5 LAMA, LABA, SABA, ICS, non-corticosteroid anti-inflammatory agent, or other active agent as described herein, whether alone or in combination with other therapies. In certain embodiments, the compositions, systems and methods described herein can be used to treat pulmonary inflammation and obstruction associated with cystic fibrosis. In specific embodiments of methods for treating patients suffering from an

10 inflammatory or obstructive pulmonary disease or condition, the pulmonary disease or condition is selected from those specifically described herein, and the method includes pulmonary delivery of a composition according to the present description to the patient via an MDI, wherein the pulmonary delivery of such composition includes administering one or more active agents at a dose or dose range as described in

15 association with the compositions disclosed herein.

#### *Metered Dose Inhaler Systems*

As described in relation to the methods provided herein, the compositions disclosed herein may be used in an MDI system. MDIs are configured to deliver a specific amount of a medicament in aerosol form. In one embodiment, an

20 MDI system includes a pressurized, liquid phase formulation-filled canister disposed in an actuator formed with a mouthpiece. The MDI system may include the formulations described herein, which include a suspension medium comprising an HFO propellant, at least one species of active agent particles and at least one species of suspending particles. The canister used in the MDI be any of any suitable configuration, and in one

25 exemplary embodiment, the canister may have a volume ranging from about 5 ml to about 25 ml, such as, for example a canister having a 19 ml volume. After shaking the device, the mouthpiece is inserted into a patient's mouth between the lips and teeth. The patient typically exhales deeply to empty the lungs and then takes a slow deep breath while actuating the cartridge.

Inside an exemplary cartridge is a metering valve including a metering chamber capable of holding a defined volume of the formulation (e.g., 63  $\mu$ l or any other suitable volume available in commercially available metering valves), which is released into an expansion chamber at the distal end of the valve stem when actuated.

5 The actuator retains the canister and may also include a port with an actuator nozzle for receiving the valve stem of the metering valve. When actuated, the specified volume of formulation travels to the expansion chamber, out the actuator nozzle and into a high-velocity spray that is drawn into the lungs of a patient.

Examples of suitable MDIs are shown and described in International  
10 Application Publication No. WO 2019/074799, which is hereby incorporated by reference in its entirety. A suitable MDI may include, for example, the aerosol delivery unit 100 for selectively delivering a dose of aerosolized matter shown in **FIGs 1-3B**, which includes structures and associated functionality for exposing a discharge passageway of the inhaler to a desiccant material at least during storage of the inhaler.

15 With reference to **FIGs 1** through **3B**, the aerosol delivery unit 100 includes a base housing 104 and a canister 110 received in the base housing 104, the canister 110 being displaceable from an initial position I, as shown in **FIG. 3A**, to a discharge position D, as shown in **FIG. 3B**, for selectively discharging a dose of aerosolized matter for inhalation by a user. The canister 110 comprises a canister  
20 body 116, which contains the matter to be discharged, and an outlet valve 112, which includes a movable valve stem 114 that extends from the canister body 116. The valve stem 114 defines a portion of a discharge passageway 120 extending from the canister body 116 to a discharge orifice 122 provided within the aerosol delivery unit 100, which in turn leads to an inhalation passageway 126 through which the aerosolized  
25 matter passes before being discharged through a mouthpiece aperture 128 for inhalation by the user during an inhalation event. The discharge passageway 120 and the inhalation passageway 126 may be collectively referred to as a drug delivery tract. As will be appreciated by those of ordinary skill in the relevant art, when the valve stem 114 is displaced relative to the canister body 116, as shown in **FIG. 3B**, a metered dose  
30 of the matter contained within the canister body 116 will be discharged through the discharge orifice 122 for inhalation by a user via the inhalation passageway 126.

With reference to **FIG. 1**, the aerosol delivery unit 100 may further include a dose counter assembly 107 secured to an upper under of the canister 110 to provide dose counting functionality and to provide a user interface for depressing the canister 110. The aerosol delivery unit 100 may also include a cap 105 to cover the mouthpiece aperture 128 of the aerosol delivery unit 100 when storing the unit 100. The cap 105 may be completely separable from the base housing 104, or may be coupled to the base housing 104 by a tether 106, which enables the cover 105 to be removed from the mouthpiece aperture 128 while still remaining coupled to the base housing 104.

With reference to **FIGs 3A** and **3B**, the aerosol delivery unit 100 further includes a desiccant chamber 150 containing a desiccant material 152 that is in fluid communication with the discharge passageway 120 at least when the aerosol delivery unit 100 is in a storage configuration and not actively discharging aerosolized matter. For example, in accordance with the example embodiment shown in **FIGs 3A** and **3B**, the desiccant chamber 150 is provided at an end of the canister 110 between a lower end of the canister body 116 and a separate desiccant housing 154 and stem seal 156 that are coupled to the end of the canister 110. The desiccant material 152 may be provided in a semi-annular form (as shown in **FIG. 2**) and may include a central passage 153 through which the valve stem 114 of the canister 110 extends. The stem seal 156 may be an annular seal formed integrally with the desiccant housing 154, such as, for example, via a multi-shot injection molding process, or may otherwise be provided as a separate seal component coupled to the desiccant housing 154. In some instances, the stem seal 156 may be provided as a bellows type seal that is secured between the valve stem 114 and the desiccant housing 154 to provide a desiccant chamber 150 having a volume that varies as the stem seal 156 is deformed as the canister 110 is displaced during an inhalation event. In other instances, such as the example embodiment shown in **FIGs 3A** and **3B**, the desiccant chamber 150 may have a fixed volume.

As can be appreciated from **FIG. 3A**, the desiccant material 152 within the desiccant chamber 150 is in fluid communication with the discharge passageway 120 through an aperture 124 in the side of the valve stem 114 that is otherwise used to

pass the matter contained in the canister body 116 toward the discharge orifice 122 when the valve stem 114 is displaced during an inhalation event. In this manner, the discharge passageway 120 remains exposed to the desiccant material 152 when the canister 110 is in the initial position I, such as when storing the unit 100. In some instances, the desiccant material may be sufficient to keep the discharge passageway dry (e.g., < 25%RH) between uses for substantially the entire product life of the canister of material to be discharged.

Advantageously, the desiccant housing 154 may be coupled to the end or collar of the canister 110 to form a cartridge 160 (**FIG. 2**) that is readily removable from the base housing 104. In this manner, the desiccant housing 154 and canister 110 may be easily removed from the base housing 104 to replace the canister 110 when depleted and/or to replace the desiccant material 152 as desired. The desiccant housing 154 may be coupled to the end or collar of the canister 110 via a resilient band, clips, detents or other fastening devices or techniques, including friction fit or interference fit arrangements. Although the desiccant chamber 150 is shown in the example embodiment of **FIGs 3A** and **3B** as being coupled to a lower end or collar of the canister 110, it is appreciated that in other embodiments a desiccant chamber may be provided in a separate desiccant housing that is coupled to the base housing 104 separate from the canister 110, the desiccant chamber may be formed integrally in the base housing itself, or the desiccant chamber may be provided in a separate component that is attached to the base housing 104. In addition, the desiccant material may be provided in a variety of different forms, such as gel form, powder form, granular form or molded form, and may consist of or comprise different materials, such as silica, activated charcoal, calcium sulfate or calcium chloride.

According to the example embodiment of **FIGs 1** through **3B**, the desiccant housing 154 may be coupled to the end or collar of the canister 110 to form a cartridge 160 that is installable in the base housing 104 to engage a stem seat/nozzle block 132 provided therein. Further details of the components of the cartridge 160 and the stem seat/nozzle block 132 can be seen in the exploded view of **FIG. 2**. As shown in **FIG. 2**, the desiccant housing 154 may form a cup-like structure with a generally cylindrical sidewall that is sized and shaped to receive a lower end of the canister 110.

The desiccant material 152 may be provided in a molded form. The desiccant material 152 may be configured to be positioned in a lower end of the desiccant housing 154. The desiccant housing 154 may include one or more locating or coupling features to assist in joining or otherwise positioning the desiccant material 152 within the desiccant housing 154. The desiccant material 152 may be shaped so as to not obstruct a valve stem aperture of the stem seal 156 provided in the desiccant housing 154 for receiving the valve stem 114 of the canister 110. For example, the desiccant material 152 may have a semi-annular shape with a central passage 153 or other clearance for the valve stem 114. In some instances, such as in the example embodiment shown in **FIGs 1** through **3B**, the desiccant material 152 may be shaped to partially encircle the valve stem 114 and may extend beyond a terminal end of the valve stem 114. The desiccant housing 154 and the desiccant material 152 may also be correspondingly shaped, and may each extend beyond a terminal end of the valve stem 114. In this manner, the desiccant material 152 may substantially fill the desiccant chamber 150 and provide a relatively large volume of desiccant material suitable to continuously remove moisture at least from the passage of the valve stem 114 throughout the usable life of the material (e.g., drug formulation) contained in the canister 110.

With reference to **FIGs 3A** and **3B**, a canister seal 117 may be positioned around the canister body 116, such as around a lower neck portion thereof, to provide a resilient member between the canister body 116 and the desiccant housing 154 which may be compressed when the canister 110 and the desiccant housing 154 are coupled together. The canister seal 117 may provide a seal location to assist in isolating the desiccant chamber 150 when the aerosol delivery unit 100 is fully assembled and in preventing the ingress of moisture into said desiccant chamber 150 other than through the discharge passageway 120. In a similar manner, the stem seal 156 may provide a seal location to assist in isolating the desiccant chamber 150 when the aerosol delivery unit 100 is fully assembled and in preventing the ingress of moisture into said desiccant chamber 150. In this manner, the desiccant chamber 150 is effectively isolated from the external environment apart from the discharge passageway 120, which may be exposed to the external environment through the inhalation passageway 126 when the mouthpiece cap 105 is removed from the base housing 104.

As can be appreciated from a review of **FIGs 3A** and **3B**, when the valve stem 114 is in an expanded position, the portion of the discharge passageway 120 defined by the valve stem 114 is in fluid communication with the desiccant chamber 152 via the aperture 124 in the side of the valve stem 114. Conversely, when the valve stem 114 of the canister 110 is fully depressed, the desiccant chamber 152 is temporarily isolated from the discharge passageway 120 defined by the valve stem 114.

Again, with the canister 100 loaded in the desiccant housing 154, the valve stem 114 protrudes from a lower end thereof to be subsequently received in the stem seat/nozzle block 132 provided in the base housing 104. According to the example embodiment of **FIG. 2**, the stem seat/nozzle block 132 may be provided in a mouthpiece unit 131 that is coupleable to the base housing 104 and includes the inhalation passageway 126 and the mouthpiece aperture 128 for delivering aerosolized matter to the user. As illustrated, when the cartridge 160 is installed, the desiccant material 152 may extend from a location above the discharge orifice 122 of the stem seat/nozzle block 132 to a location below the discharge orifice 122, and may substantially fill the desiccant chamber 150 within the desiccant housing 154 to provide a relatively large volume of desiccant material suitable to continuously remove moisture at least from the passage of the valve stem 114 throughout the usable life of the material (e.g., drug formulation) contained in the canister 110. In this manner, embodiments may be particularly well suited to eliminate, reduce or minimize the presence of moisture in the discharge passageway 120 and to eliminate, reduce or minimize any fouling associated therewith even when not completely isolating the discharge passageway 120 from the external environment after discharging the material during the inhalation event.

According to some embodiments, an MDI is provided, such as the aerosol delivery unit 100 shown in **FIGs 1-3B**, wherein one or more internal components of the outlet valve 112 is at least partially composed of bromobutyl material (e.g., bromobutyl rubber).

For example, **FIG. 4** illustrates an outlet valve 200 of a canister 201 of an MDI containing a formulation to be discharged, wherein the outlet valve 200 is provided with one or more internal components that comprise or consist of a

bromobutyl material (e.g., bromobutyl rubber). For instance, the outlet valve 200 includes an inner core 202 and a valve stem 204 that are movably displaceable relative to a valve body 206 and to a metering chamber 208 to dispense a metered amount of a formulation through a discharge passageway 205 of the outlet valve 200 during  
5 operation of the MDI device. The inner core 202 and the valve stem 204 are biased toward an extended position by a spring element 207 and are selectively depressible to dispense a metered dose of formulation.

To assist in establishing a consistent metered dose of formulation to be discharged, the outlet valve 200 further comprises a plurality of gaskets to seal and  
10 isolate an internal cavity of the metering chamber 208 relative to the valve body 206 and the canister 201 and to seal and isolate an internal formulation cavity of the canister 201 from an external environment. More particularly, upper and lower seat gaskets 212a,b are provided that slidably engage the inner core 202 and the valve stem 204 to seal and isolate the internal cavity of the metering chamber 208 relative to the valve  
15 body 206 and the canister 201. As shown in **FIG. 4**, the upper seat gasket 212a is provided between the metering chamber 208 and the valve body 206 and encircles and seals against a portion of the displaceable inner core 202. The lower seat gasket 212b is provided between the metering chamber 208 and the canister 201 and encircles and seals against a portion of the displaceable valve stem 204, which projects from the  
20 canister 201. Advantageously, one or more of the seat gaskets 212a,b may comprise or consist of a bromobutyl material (e.g., bromobutyl rubber). In addition, as further shown in **FIG. 4**, a neck gasket 214 is provided between the valve body 206 and the canister 201 to further assist in sealing and isolating the internal formulation cavity from the external environment. Advantageously, the neck gasket 214 may comprise or  
25 consist of a bromobutyl material (e.g., bromobutyl rubber).

It has been shown that by forming one or more of the internal gaskets of the outlet valve 200, namely, one or more of the seat gaskets 212a,b and/or the neck gasket 214, to comprise or consist of a bromobutyl material (e.g., bromobutyl rubber), the outlet valve 200 is particularly effective in discharging and maintaining a consistent  
30 metered dose of the formulation throughout operation over time and in avoiding fouling or clogging of a discharge orifice of the MDI device. In addition, the outlet valve 200

is particularly effective in avoiding formulation weight loss over time compared to other suitable gasket materials. Accordingly, such a configured MDI is particularly well suited to deliver formulation to a user.

As an example, **FIG. 5** shows a CT scan of a discharge passageway of an MDI having a formulation canister with an outlet valve that includes internal seat and neck gaskets composed of a bromobutyl material (e.g., bromobutyl rubber), wherein the MDI was used to repeatedly discharge a formulation under controlled environmental conditions (25°C / 60% RH). Notably, **FIG. 5** shows a discharge orifice of the MDI substantially free of deposited or accumulated matter despite repeated use of the MDI to dispense formulations described herein.

**FIG. 6** provides a comparison of formulation weight loss over time for different valve seat gasket and valve neck gasket materials. As can be appreciated from **FIG. 6**, configurations in which the valve neck gasket composed a bromobutyl material (e.g., bromobutyl rubber) consistently showed significant reductions in weight loss over time as compared to a control configuration (leftmost column in the chart). Further, when the valve seat gaskets also composed a bromobutyl material, e.g., bromobutyl rubber, (rightmost columns in the chart), the weight loss over time approached 0%. As such, providing internal gaskets composed of a bromobutyl material (e.g., bromobutyl rubber) showed unexpected performance.

20

The following abbreviations are used throughout the present disclosure including the Drawing and Examples:

- AB: Albuterol
- AS: Albuterol Sulfate
- 25 • BD: Budesonide
- FF: Formoterol Fumarate
- GP: Glycopyrrolate
- RF: Roflumilast
- BDA: budesonide/albuterol (combo)
- 30 • BGF: budesonide/glycopyrrolate/formoterol (combo)
- GFF: glycopyrrolate/formoterol fumarate (combo)

- BFF: budesonide/formoterol fumarate (combo)
- BGFR: budesonide/glycopyrrolate/formoterol fumarate/roflumilast (combo)
- BDA-1234ze: budesonide/albuterol (combo) in HFO-1234ze(E) formulation
- BDA-134a: budesonide/albuterol (combo) in HFA-134a formulation
- BFF-1234ze: budesonide/formoterol fumarate (combo) in HFO-1234ze(E) formulation
- BFF-134a: budesonide/formoterol fumarate (combo) in HFA-134a formulation
- CFC-11: Trichlorofluoromethane
- CFC-113: 1,1,2-Trichloro-1,2,2-trifluoroethane
- CFC-114: 1,2-Dichlorotetrafluoroethane
- HCFC-124: 1-Chloro-1,2,2,2-tetrafluoroethane
- HFA-227ea: 1,1,1,2,3,3,3-Heptafluoropropane
- HFC-125: Pentafluoroethane, also known as 1,1,1,2,2-Pentafluoroethane
- HFC-152a: 1,1-Difluoroethane
- HFC-245cb: 1,1,1,2,2-Pentafluoropropane
- HFO-1225ye(Z): *cis*-1,2,3,3,3-Pentafluoropropene
- HFO-1225ye(E): *trans*-1,2,3,3,3-Pentafluoropropene
- HFO-1234yf: 2,3,3,3-Tetrafluoropropene
- HFO-1234ze(Z): *cis*-1,3,3,3-Tetrafluoroprop-1-ene
- PP: Porous Particles of Phospholipids

25

### *Specific Embodiments*

In one aspect, the present disclosure provides the following specific embodiment:

- 30 Embodiment 1. A pharmaceutical composition deliverable from a metered dose inhaler, the pharmaceutical composition comprising:

a propellant of pharmaceutical grade (1E)-1,3,3,3-Tetrafluoro-1-propene (HFO-1234ze(E));

a plurality of active agent particles; and

a plurality of phospholipid particles comprising perforated microstructures;

5 wherein the active agent particles comprise an active agent selected from a long-acting muscarinic antagonist (LAMA), a long-acting  $\beta$ 2-agonists (LABA), a short-acting beta-agonists (SABA), an inhaled corticosteroid (ICS), and a non-corticosteroid anti-inflammatory agent.

10 Embodiment 2. The pharmaceutical composition according to Embodiment 1, wherein the plurality of active agent particles comprises two or more species of active agent particles, wherein each species of active agent particle comprises a different active agent selected from a long-acting muscarinic antagonist (LAMA), a long-acting  $\beta$ 2-agonists (LABA), a short-acting beta-agonists (SABA), an inhaled corticosteroid  
15 (ICS), and a non-corticosteroid anti-inflammatory agent.

Embodiment 3. A pharmaceutical composition deliverable from a metered dose inhaler, the pharmaceutical composition comprising:

20 a propellant of pharmaceutical grade (1E)-1,3,3,3-Tetrafluoro-1-propene (HFO-1234ze(E));

a plurality of a first species of active agent particle;

a plurality of a second species of active agent particle; and

a plurality of phospholipid particles comprising perforated microstructures;

25 wherein the first species of active agent particles comprise a first active agent and the second species of active agent particles comprise a second active agent, and wherein the first and second active agents are selected from a long-acting muscarinic antagonist (LAMA), a long-acting  $\beta$ 2-agonists (LABA), a short-acting beta-agonists (SABA), an inhaled corticosteroid (ICS), and a non-corticosteroid anti-inflammatory agent.

30

Embodiment 4. The pharmaceutical composition according to Embodiment 3, further comprising a plurality of a third species of active agent particle; wherein the third species of active agent particles comprise a third active agent selected from a long-

acting muscarinic antagonist (LAMA), a long-acting  $\beta$ 2-agonists (LABA), a short-acting beta-agonists (SABA), an inhaled corticosteroid (ICS), and a non-corticosteroid anti-inflammatory agent.

- 5 Embodiment 5. The pharmaceutical composition according to Embodiment 4, further comprising a plurality of a fourth species of active agent particle; wherein the fourth species of active agent particles comprise a fourth active agent selected from a long-acting muscarinic antagonist (LAMA), a long-acting  $\beta$ 2-agonists (LABA), a short-acting beta-agonists (SABA), an inhaled corticosteroid (ICS), and a non-corticosteroid  
10 anti-inflammatory agent.

Embodiment 6. The pharmaceutical composition according to any one of Embodiments 1 to 5, wherein the LAMA is present at a concentration in the range of about 0.04 mg/mL to about 2.25 mg/mL.

15

Embodiment 7. The pharmaceutical composition according to any one of Embodiments 1 to 5, wherein the LABA is present at a concentration in the range of about 0.01 mg/mL to about 1 mg/mL.

- 20 Embodiment 8. The pharmaceutical composition according to any one of Embodiments 1 to 5, wherein the ICS is present at a concentration in the range of about 0.1 mg/mL to about 20 mg/mL.

- Embodiment 9. The pharmaceutical composition according to any one of  
25 Embodiments 1 to 5, wherein the non-corticosteroid anti-inflammatory agent is present at a concentration in the range of about 0.1 mg/mL to about 20 mg/mL.

- Embodiment 10. The pharmaceutical composition according to any one of Embodiments 1 to 9, wherein the phospholipid particles are present at a concentration  
30 in the range of about 0.1 mg/mL to about 10 mg/mL.

Embodiment 11. The pharmaceutical composition according to any one of Embodiments 1 to 10, wherein the perforated microstructures comprise 1,2-Distearoyl-sn-glycero-3-phosphocholine (DSPC) and calcium chloride.

- 5 Embodiment 12. The pharmaceutical composition according to any one of Embodiments 1 to 11, wherein the phospholipid particles exhibit a volume median optical diameter selected from between about 0.2  $\mu\text{m}$  and about 50  $\mu\text{m}$ , between about 0.5  $\mu\text{m}$  and about 15  $\mu\text{m}$ , between about 1.5  $\mu\text{m}$  and about 10  $\mu\text{m}$ , and between about 2  $\mu\text{m}$  and about 5  $\mu\text{m}$ .

10

Embodiment 13. The pharmaceutical composition according to any one of Embodiments 1 to 12 wherein a total mass of the phospholipid particles exceeds a total mass of:

- i) the plurality of active agent particles of Embodiment 1;  
15 ii) any one of the first, second, third, or fourth species of active agent particles; or  
iii) the combination of any two of the first, second, third, and fourth species of active agent particles.

- Embodiment 14. The pharmaceutical composition according to any one of  
20 Embodiments 3 to 13 wherein the first active agent is a LAMA; and the second active agent is a LABA.

- Embodiment 15. The pharmaceutical composition according to any one of  
Embodiments 4 to 13, wherein the first active agent is a LAMA; the second active agent  
25 is a LABA; and the third active agent is an ICS.

- Embodiment 16. The pharmaceutical composition according to any one of  
Embodiments 5 to 13, wherein the first active agent is a LAMA; the second active agent  
is a LABA; the third active agent is an ICS; and the fourth active agent is a non-  
30 corticosteroid anti-inflammatory agent.

Embodiment 17. The pharmaceutical composition according to any one of Embodiments 3 to 13, wherein the first active agent is a SABA; and the second active agent is an ICS.

- 5 Embodiment 18. The pharmaceutical composition according to any one of Embodiments 3 to 13, wherein the first active agent is a LABA; and the second active agent is an ICS.

- Embodiment 19. The pharmaceutical composition according to any one of the  
10 preceding Embodiments, wherein the LAMA is selected from glycopyrrolate, dexpirronium, tiotropium, tropium, aclidinium, umeclidinium, and darotroprum; or a pharmaceutically acceptable salt or solvate thereof.

- Embodiment 20. The pharmaceutical composition according to any one of the  
15 preceding Embodiments, wherein the LABA is selected from bambuterol, clenbuterol, formoterol, salmeterol, carmoterol, milveterol, indacaterol, vilanterol, and saligenin- or indole-containing and adamantyl-derived  $\beta_2$  agonists; or a pharmaceutically acceptable salt or solvate thereof.

- 20 Embodiment 21. The pharmaceutical composition according to any one of the preceding Embodiments, wherein the SABA is selected from bitolterol, carbuterol, fenoterol, hexoprenaline, isoprenaline (isoproterenol), levosalbutamol, orciprenaline (metaproterenol), pirbuterol, procaterol, rimiterol, albuterol (salbutamol), terbutaline, tulobuterol, reproterol, and epinephrine; or a pharmaceutically acceptable salt or solvate  
25 thereof.

- Embodiment 22. The pharmaceutical composition according to any one of the preceding Embodiments, wherein the ICS is selected from beclomethasone, budesonide, ciclesonide, flunisolide, fluticasone, methylprednisolone, mometasone, prednisone and  
30 triamcinolone; or a pharmaceutically acceptable salt or solvate thereof.

Embodiment 23. The pharmaceutical composition according to any one of the preceding Embodiments, wherein the non-corticosteroid anti-inflammatory agent is roflumilast or a pharmaceutically acceptable salt or solvate thereof.

- 5 Embodiment 24. The pharmaceutical composition according to any one of the preceding Embodiments, exhibiting an enhanced robustness in simulated use testing (SUT).

- 10 Embodiment 25. The pharmaceutical composition according to any one of the preceding Embodiments, exhibiting less than about 1.0%, 0.5%, 0.4%, 0.3%, 0.2%, or 0.1% weight loss in the metered dose inhaler at 25°C/60% RH per year.

Embodiment 26. The pharmaceutical composition according to any one of the preceding Embodiments, comprising:

- 15 a propellant of pharmaceutical grade HFO-1234ze(E);  
a plurality of glycopyrrolate particles;  
a plurality of formoterol particles; and  
a plurality of phospholipid particles comprising perforated microstructures.

- 20 Embodiment 27. The pharmaceutical composition according to any one of the preceding Embodiments, comprising:

- a propellant of pharmaceutical grade HFO-1234ze(E);  
a plurality of glycopyrrolate particles;  
a plurality of formoterol particles;  
25 a plurality of budesonide particles; and  
a plurality of phospholipid particles comprising perforated microstructures.

Embodiment 28. The pharmaceutical composition according to any one of the preceding Embodiments, comprising:

- 30 a propellant of pharmaceutical grade HFO-1234ze(E);  
a plurality of albuterol particles;  
a plurality of budesonide particles; and  
a plurality of phospholipid particles comprising perforated microstructures.

Embodiment 29. The pharmaceutical composition according to any one of the preceding Embodiments, comprising:

- 5 a propellant of pharmaceutical grade HFO-1234ze(E);
- a plurality of formoterol particles;
- a plurality of budesonide particles; and
- a plurality of phospholipid particles comprising perforated microstructures.

10 Embodiment 30. The pharmaceutical composition according to any one of the preceding Embodiments, comprising:

- a propellant of pharmaceutical grade HFO-1234ze(E);
- a plurality of glycopyrrolate particles;
- a plurality of formoterol particles;
- a plurality of budesonide particles;
- 15 a plurality of roflumilast particles; and
- a plurality of phospholipid particles comprising perforated microstructures.

Embodiment 31. The pharmaceutical composition according to any one of the preceding Embodiments, wherein the glycopyrrolate active agent particles are in the  
20 propellant at a concentration sufficient to provide a delivered dose of glycopyrrolate per actuation of the metered dose inhaler selected from between about 5 µg and about 50 µg per actuation, between about 2 µg and about 25 µg per actuation, and between about 6 µg and about 15 µg per actuation.

25 Embodiment 32. The pharmaceutical composition according to any one of the preceding Embodiments, wherein the concentration of glycopyrrolate in the propellant is between about 0.04 mg/ml and about 2.25 mg/ml.

Embodiment 33. The pharmaceutical composition according to any one of the  
30 preceding Embodiments, wherein at least 90% of the glycopyrrolate active agent particles by volume exhibit an optical diameter of 7 µm or less.

Embodiment 34. The pharmaceutical composition according to any one of the preceding Embodiments, wherein the formoterol active agent particles are included in the composition at a concentration sufficient to provide a delivered dose of formoterol selected from between about 1  $\mu\text{g}$  and about 30  $\mu\text{g}$ , between about 0.5  $\mu\text{g}$  and about 10  $\mu\text{g}$ , between about 2  $\mu\text{g}$  and 5  $\mu\text{g}$ , between about 3  $\mu\text{g}$  and about 10  $\mu\text{g}$ , between about 5  $\mu\text{g}$  and about 10  $\mu\text{g}$ , and between 3  $\mu\text{g}$  and about 30  $\mu\text{g}$  per actuation of the metered dose inhaler.

Embodiment 35. The pharmaceutical composition according to any one of the preceding Embodiments, wherein the concentration of formoterol in the propellant is selected from between about 0.01 mg/ml and about 1 mg/ml, between about 0.01 mg/ml and about 0.5 mg/ml, and between about 0.03 mg/ml and about 0.4 mg/ml.

Embodiment 36. The pharmaceutical composition according to any one of the preceding Embodiments, wherein at least 90% of the formoterol active agent particles by volume exhibit an optical diameter of 5  $\mu\text{m}$  or less.

Embodiment 37. The pharmaceutical composition according to any one of the preceding Embodiments, wherein the budesonide active agent particles are included in the composition at a concentration sufficient to provide a delivered dose of budesonide selected from between about 50  $\mu\text{g}$  and about 400  $\mu\text{g}$ , between about 20  $\mu\text{g}$  and about 600  $\mu\text{g}$ , between about 30  $\mu\text{g}$  and 100  $\mu\text{g}$ , between about 50  $\mu\text{g}$  and about 200  $\mu\text{g}$ , and between about 150  $\mu\text{g}$  and about 350  $\mu\text{g}$  per actuation of the metered dose inhaler.

Embodiment 38. The pharmaceutical composition according to any one of the preceding Embodiments, wherein the concentration of budesonide in the propellant is selected from between about 0.1 mg/ml and about 20 mg/ml, between about 0.1 mg/ml and about 5 mg/ml, and between about 0.3 mg/ml and about 6 mg/ml.

Embodiment 39. The pharmaceutical composition according to any one of the preceding Embodiments, wherein at least 90% of the budesonide active agent particles by volume exhibit an optical diameter of 7  $\mu\text{m}$  or less.

Embodiment 40. The pharmaceutical composition according to any one of the preceding Embodiments, wherein the albuterol active agent particles are included in the composition at a concentration sufficient to provide a delivered dose of albuterol selected from between about 10  $\mu\text{g}$  and about 200  $\mu\text{g}$ , between about 20  $\mu\text{g}$  and about 5 300  $\mu\text{g}$ , between about 30  $\mu\text{g}$  and 150  $\mu\text{g}$ , and between about 50  $\mu\text{g}$  and about 200  $\mu\text{g}$  per actuation of the metered dose inhaler.

Embodiment 41. The pharmaceutical composition according to any one of the preceding Embodiments, wherein the concentration of albuterol in the propellant is 10 selected from between about 0.1 mg/ml and about 10 mg/ml, between about 0.1 mg/ml and about 5 mg/ml, and between about 0.3 mg/ml and about 4 mg/ml.

Embodiment 42. The pharmaceutical composition according to any one of the preceding Embodiments, wherein at least 90% of the albuterol active agent particles by 15 volume exhibit an optical diameter of 5  $\mu\text{m}$  or less.

Embodiment 43. The pharmaceutical composition according to any one of the preceding Embodiments, wherein the roflumilast active agent particles are included in the composition at a concentration sufficient to provide a delivered dose of roflumilast 20 selected from between about 50  $\mu\text{g}$  and about 400  $\mu\text{g}$ , between about 20  $\mu\text{g}$  and about 600  $\mu\text{g}$ , between about 30  $\mu\text{g}$  and 100  $\mu\text{g}$ , between about 50  $\mu\text{g}$  and about 200  $\mu\text{g}$ , and between about 150  $\mu\text{g}$  and about 350  $\mu\text{g}$  per actuation of the metered dose inhaler.

Embodiment 44. The pharmaceutical composition according to any one of the preceding Embodiments, wherein the concentration of roflumilast in the propellant is 25 selected from between about 0.1 mg/ml and about 20 mg/ml, between about 0.1 mg/ml and about 5 mg/ml, and between about 0.3 mg/ml and about 6 mg/ml.

Embodiment 45. The pharmaceutical composition according to any one of the preceding Embodiments, wherein at least 90% of the roflumilast active agent particles 30 by volume exhibit an optical diameter of 5  $\mu\text{m}$  or less.

Embodiment 46. The pharmaceutical composition according to any one of the preceding Embodiments, wherein the glycopyrrolate particles comprise glycopyrrolate or a pharmaceutically acceptable salt thereof.

- 5 Embodiment 47. The pharmaceutical composition according to Embodiment 46, wherein the glycopyrrolate or a pharmaceutically acceptable salt thereof is in crystalline and/or micronized form.

- 10 Embodiment 48. The pharmaceutical composition according to any one of the preceding Embodiments, wherein the formoterol particles comprise formoterol or a pharmaceutically acceptable salt thereof.

- 15 Embodiment 49. The pharmaceutical composition according to Embodiment 48, wherein the formoterol or a pharmaceutically acceptable salt thereof is in crystalline and/or micronized form.

- 20 Embodiment 50. The pharmaceutical composition according to any one of the preceding Embodiments, wherein the albuterol particles comprise albuterol or a pharmaceutically acceptable salt thereof.

- Embodiment 51. The pharmaceutical composition according to Embodiment 50, wherein the albuterol or a pharmaceutically acceptable salt thereof is in crystalline and/or micronized form.

- 25 Embodiment 52. The pharmaceutical composition according to any one of the preceding Embodiments, wherein the budesonide particles comprise budesonide which is in crystalline and/or micronized form.

- 30 Embodiment 53. The pharmaceutical composition according to any one of the preceding Embodiments, wherein the roflumilast particles comprise roflumilast or a pharmaceutically acceptable salt thereof.

Embodiment 54. The pharmaceutical composition according to Embodiment 53, wherein the roflumilast or a pharmaceutically acceptable salt thereof is in crystalline and/or micronized form.

5 Embodiment 55. A metered dose inhaler comprising a canister with an outlet valve including an actuator for dispensing a metered amount of a pharmaceutical composition according to any one of Embodiments 1 through 54, wherein the canister contains the pharmaceutical composition.

10 Embodiment 56. The metered dose inhaler according to Embodiment 55, exhibiting an enhanced robustness in simulated use testing (SUT).

Embodiment 57. The metered dose inhaler according to Embodiment 55 or 56, exhibiting less than about 10%, 9%, 8%, 7%, 6%, or 5% reduced shot weight per  
15 actuation throughout emptying of the canister.

Embodiment 58. The metered dose inhaler according to any one of Embodiments 55 to 57, exhibiting less than about 1.0%, 0.5%, 0.4%, 0.3%, 0.2%, or 0.1% weight loss at 25°C/60% RH per year.

20

Embodiment 59. The metered dose inhaler according to any one of Embodiments 55 to 58, wherein at least one internal gasket of the outlet valve is at least partially composed of bromobutyl material.

25 Embodiment 60. The metered dose inhaler according to any one of Embodiments 55 to 59, wherein the outlet valve comprises a neck gasket and at least one seat gasket; and the neck gasket and/or the at least one seat gasket is composed of bromobutyl material.

30 Embodiment 61. The metered dose inhaler according to any one of Embodiments 55 to 60, which exhibits a delivered dose uniformity (DDU) for the pharmaceutical formulation selected from a DDU of  $\pm 20\%$ , or better, a DDU of  $\pm 15\%$ , or better, and a DDU of  $\pm 10\%$ , or better, throughout emptying of the canister.

Embodiment 62. The metered dose inhaler according to any one of Embodiments 55 to 61, which dispenses the pharmaceutical composition at an initial fine particle fraction and the initial fine particle fraction dispensed from the metered dose inhaler is substantially maintained, such that, throughout emptying of the canister, the fine particle fraction delivered from the metered dose inhaler is maintained within 85% of the initial fine particle fraction.

Embodiment 63. The metered dose inhaler according to Embodiment 62, wherein the fine particle fraction delivered from the metered dose inhaler is maintained within 95% of the initial fine particle fraction.

Embodiment 64. A method of treating a pulmonary disease or disorder in a patient, comprising administering a pharmaceutical composition according to any one of Embodiments 1 to 54 to the patient by actuating a metered dose inhaler; wherein the metered dose inhaler contains the pharmaceutical composition.

Embodiment 65. The method of Embodiment 64, wherein the pulmonary disease or disorder is selected from at least one of asthma, chronic obstructive pulmonary disease (COPD), allergic rhinitis, sinusitis, pulmonary vasoconstriction, inflammation, allergies, impeded respiration, respiratory distress syndrome, pulmonary hypertension, pulmonary inflammation associated with cystic fibrosis, and pulmonary obstruction associated with cystic fibrosis.

Embodiment 66. The method of Embodiment 64 or 65, wherein the pulmonary disease or disorder is asthma or COPD.

Embodiment 67. The method of any one of Embodiments 64 to 66, wherein the metered dose inhaler is described according to any one of the Embodiments 54 to 63.

Embodiment 68. The pharmaceutical composition according to any one of Embodiments 1 to 54 for use in the manufacture of a medicament for the treatment of a pulmonary disease or disorder.

- Embodiment 69. The pharmaceutical composition according to any one of Embodiments 1 to 54 for use in the treatment of a pulmonary disease or disorder.
- 5 Embodiment 70. The pharmaceutical composition according to any one of Embodiments 1 to 54, which exhibits  $C_{max}$ ,  $AUC_{inf}$  or  $AUC_{last}$  of any one or more of the active agents, which is about 80% to about 125% of  $C_{max}$ ,  $AUC_{inf}$  or  $AUC_{last}$  of the one or more of the active agents of a reference pharmaceutical composition.
- 10 Embodiment 71. The metered dose inhaler according to any one of Embodiments 55 to 63, wherein the pharmaceutical composition exhibits  $C_{max}$ ,  $AUC_{inf}$  or  $AUC_{last}$  of any one or more of the active agents, which is about 80% to about 125% of  $C_{max}$ ,  $AUC_{inf}$  or  $AUC_{last}$  of the one or more of the active agents of a reference pharmaceutical composition.
- 15 Embodiment 72. The method according to any one of Embodiments 64 to 67, wherein the pharmaceutical composition exhibits  $C_{max}$ ,  $AUC_{inf}$  or  $AUC_{last}$  of any one or more of the active agents, which is about 80% to about 125% of  $C_{max}$ ,  $AUC_{inf}$  or  $AUC_{last}$  of the one or more of the active agents of a reference pharmaceutical
- 20 composition.

The specific examples included herein are for illustrative purposes only and are not to be considered as limiting to this disclosure. Moreover, the compositions, systems and methods disclosed herein have been described in relation to certain

25 embodiments thereof, and many details have been set forth for purposes of illustration, it will be apparent to those skilled in the art that the disclosure is susceptible to additional embodiments and that certain of the details described herein may be varied without departing from the basic principles of the disclosure. Any active agents and reagents used in the following examples are either commercially available or, with the

30 benefit of the teachings provided herein, can be prepared according to standard literature procedures by those skilled in the art. The entire contents of all publications,

patents, and patent applications referenced herein are hereby incorporated herein by reference.

## EXAMPLES

### 5 *Example 1*

Suspending particles were manufactured by spray drying an emulsion of PFOB (perfluorooctyl bromide) and water stabilized by DSPC (1,2-Distearoyl-sn-Glycero-3-Phosphocholine). Detailed preparation procedures can be found in WO 2010/138862, WO 2010/138868, and WO 2010/138884, the contents of which are  
10 herein incorporated by reference in their entireties. The particle size distribution of the suspending particles was determined by laser diffraction. 50% by volume of the suspending particles were smaller than 2.9  $\mu\text{m}$ , the Geometric Standard Deviation of the distribution was 1.8.

Active agent particles formed of glycopyrrolate (Pyrrolidinium, 3-  
15 ((cyclopentylhydroxyphenylacetyl)oxy)-1,1-dimethyl-, bromide) were formed by micronizing glycopyrrolate using a jet mill. The particle size distribution of the micronized glycopyrrolate (GP) was determined by laser diffraction. 50% by volume of the micronized particles exhibited an optical diameter smaller than 2.1  $\mu\text{m}$ , 90% by volume were smaller than 5  $\mu\text{m}$ .

20 Formoterol fumarate, ( $\pm$ )-2-hydroxy-5-[(1RS)-1-hydroxy-2-[[[(1RS)-2-(4-methoxyphenyl)-1-methylethyl]-amino]ethyl]formanilide fumarate, also known as ( $\pm$ )-2'-hydroxy-5-[(RS)-1-hydroxy-2-[[RS)-p-methoxy- $\alpha$ -methylphenethyl]-amine]ethyl]formanilide fumarate, dihydrate was received micronized by the manufacturer (Inke) and used as active agent particles. The particle size distribution of  
25 the micronized formoterol fumarate (FF) was determined by laser diffraction. 50% by volume of the micronized particles exhibited an optical diameter smaller than 1.6  $\mu\text{m}$ , and 90% by volume exhibited an optical diameter smaller than 3.9  $\mu\text{m}$ .

Active agent particles formed of budesonide, 16,17-  
(butylidenebis(oxy))-11,21-dihydroxy-(11- $\beta$ ,16- $\alpha$ )-pregna-1,4-diene-3,20-dione, were  
30 formed by micronizing budesonide using a jet mill. The particle size distribution of the

budesonide (BD) was determined by laser diffraction. 50% by volume of the micronized particles exhibited an optical diameter smaller than 1.9  $\mu\text{m}$ , 90% by volume exhibited an optical diameter smaller than 4.3  $\mu\text{m}$ .

Active agent particles formed of albuterol were formed by micronizing  
5 albuterol sulfate using a jet mill. The particle size distribution of the albuterol sulfate (AS) was determined by laser diffraction. 50% by volume of the micronized particles exhibited an optical diameter smaller than 1.5  $\mu\text{m}$ , 90% by volume exhibited an optical diameter smaller than 3.3  $\mu\text{m}$ .

Active agent particles formed of roflumilast were formed by micronizing  
10 roflumilast using a jet mill. The particle size distribution of the roflumilast (RF) was determined by laser diffraction. 50% by volume of the micronized particles exhibited an optical diameter smaller than 1.0  $\mu\text{m}$ , 90% by volume exhibited an optical diameter smaller than 2.4  $\mu\text{m}$ .

Metered dose inhalers were prepared by first dispensing the appropriate  
15 quantities of suspending particles and active agent particles in an addition vessel (AV) and adding an appropriate quantity of HFO-1234ze(E) (1,3,3,3-Tetrafluoropropene) propellant. The mixture is agitated to facilitate powder wetting and then transferred to a pressure vessel where the suspension is mixed. Valves comprised of 50  $\mu\text{L}$  metering chambers (BK357, Bepak, King's Lynn, UK) are crimped onto fluorinated ethylene  
20 polymer (FEP) coated aluminum cans (Presspart, Blackburn, UK) and the suspension is then pressure filled through the valve. The canisters were fitted with polypropylene actuators with a 0.32 mm orifice (# 10024269, Bepak, King's Lynn, UK).

### *Example 2*

25 Metered dose inhalers containing a triple co-suspension composition comprising glycopyrrolate, budesonide, and formoterol active agent particles were prepared, with each type of active agent particle being provided as a micronized, crystalline API material. The active agent particles were suspended in HFO-1234ze(E) propellant, either with or without phospholipid particles. In the formulation containing  
30 phospholipid particles, the three types of active agent particles showed uniform deposition distributions as shown in **FIG. 7**. The three types of active agent particles

showed individual deposition distributions in the formulation without phospholipid particles.

*Example 3*

5 Metered dose inhalers containing a triple co-suspension composition comprising glycopyrrolate, budesonide, and formoterol active agent particles were prepared, with each type of active agent particle being provided as a micronized, crystalline API material. The active agent particles were suspended in HFA-134a propellant or in HFO-1234ze(E) propellant, without phospholipid particles. The  
10 deposition distribution of budesonide in each formulation was tested at 0% and at 50% relative humidity. The HFA-134 propellant formulation showed a greater impact of relative humidity upon the deposition distribution than did the HFO-1234ze(E) propellant.

15 *Example 4*

Metered dose inhalers containing a dual co-suspension composition comprising budesonide and formoterol active agent particles were prepared, with each type of active agent particle being provided as a micronized, crystalline API material. The active agent particles were suspended in HFO-1234ze(E) propellant, either with or  
20 without phospholipid particles. As shown in **FIG. 15**, the two types of active agent particles and the suspending particles showed a uniform deposition distribution. Table 6 provides the FPF (Fine Particle Fraction), FPD (Fine Particle Dose), MMAD (Mass Median Aerodynamic Diameter), and Throat Deposition as characterized by NGI (Next Generation Impactor). As shown in **FIGs 16 and 17**, budesonide and formoterol  
25 fumarate, respectively, produced a similar aPSD (aerodynamic particle size distributions) by NGI in HFO-1234ze(E) as in HFA-134a. Table 7 provides the FPF (Fine Particle Fraction), FPD (Fine Particle Dose), MMAD (Mass Median Aerodynamic Diameter), and Throat Deposition as characterized by NGI (Next Generation Impactor). As shown in **FIGs 18, 19, and 20**, the aPSD of budesonide,  
30 formoterol fumarate, and the suspending particle depicted as DSPC, respectively, was stable for twelve months when stored valve down and protected at 25°C/60% RH. Table

8 provides the FPF (Fine Particle Fraction), FPD (Fine Particle Dose), MMAD (Mass Median Aerodynamic Diameter), and Throat Deposition as characterized by NGI (Next Generation Impactor). As shown in **FIG. 21**, budesonide and formoterol fumarate demonstrated consistent delivered dose as represented as %LC (percent of label claim) and were stable for twelve months when stored valve down and protected at 25°C/60% RH.

**Table 6.** BD, FF, and DSPC Fine Particle Fraction (FPF), Fine Particle Dose (FPD), Mass Median Aerodynamic Diameter (MMAD), and Throat Deposition of BFF-1234ze

Active	FPF, <6.4 $\mu\text{m}$ (%)	FPD, <6.4 $\mu\text{m}$ ( $\mu\text{g}/\text{act}$ )	MMAD ( $\mu\text{m}$ )	Throat Deposition (%)
BD	50	79.3	3.87	35.4
FF	51	2.4	3.73	34.8
DSPC	50	131.7	3.64	36.3

10

**Table 7.** BD and FF Fine Particle Fraction (FPF), Fine Particle Dose (FPD), Mass Median Aerodynamic Diameter (MMAD), and Throat Deposition of BFF-1234ze and BFF-134a formulations as characterized by NGI

Active	Formulation	FPF, <6.4 $\mu\text{m}$ (%)	FPD, <6.4 $\mu\text{m}$ ( $\mu\text{g}/\text{act}$ )	MMAD ( $\mu\text{m}$ )	Throat Deposition (%)
BD	BFF-134a	52	81.8	3.54	66.7
	BFF-1234ze	50	79.3	3.87	65.6
FF	BFF-134a	53	2.5	3.38	2.0
	BFF-1234ze	51	2.4	3.73	1.9

15 **Table 8.** BD, FF, and DSPC Fine Particle Fraction (FPF), Fine Particle Dose (FPD), Mass Median Aerodynamic Diameter (MMAD), and Throat Deposition Stability Data for BFF-1234ze

Active	Storage	FPF, <6.4 $\mu\text{m}$ (%)	FPD, <6.4 $\mu\text{m}$ ( $\mu\text{g}/\text{act}$ )	MMAD ( $\mu\text{m}$ )	Throat Deposition (%)
BD	Initial	50	79.3	3.87	65.6
	6 month	52	70.5	3.72	55.1

	25°C/60%RH				
	12 month 25°C /60%RH	53	86.8	3.58	64.4
FF	Initial	51	2.4	3.73	1.9
	6 month 25°C/60%RH	54	2.1	3.53	1.5
	12 month 25°C /60%RH	56	2.6	3.36	1.8
DSPC	Initial	50	131.7	3.64	107.3
	6 month 25°C/60%RH	55	122.1	3.47	79.0
	12 month 25°C /60%RH	57	150.9	3.33	64.3

In the formulation without phospholipid particles, the two types of active agent particles showed individual deposition distributions, while in the formulation containing phospholipid particles, the two types of active agent particles showed uniform deposition distributions.

#### *Example 5*

Metered dose inhalers containing a dual co-suspension composition comprising budesonide and albuterol active agent particles were prepared, with each type of active agent particle being provided as a micronized, crystalline API material. The active agent particles were suspended in HFO-1234ze(E) propellant, either with or without phospholipid particles. As shown in **FIG. 22**, the two types of active agent particles and the suspending particles showed a uniform deposition distribution. Table 9 provides the FPF (Fine Particle Fraction), FPD (Fine Particle Dose), MMAD (Mass Median Aerodynamic Diameter), and Throat Deposition as characterized by NGI (Next Generation Impactor). As shown in **FIGs 23** and **24**, budesonide and albuterol, respectively, produced a similar aPSD (aerodynamic particle size distributions) by NGI in HFO-1234ze(E) as in HFA-134a. Table 10 provides the FPF (Fine Particle

Fraction), FPD (Fine Particle Dose), MMAD (Mass Median Aerodynamic Diameter), and Throat Deposition as characterized by NGI (Next Generation Impactor). As shown in FIGs 25, and 26, the aPSD of budesonide and albuterol, respectively, was stable for twelve months when stored valve down and protected at 25°C/60% RH. Table 11

5 provides the FPF (Fine Particle Fraction), FPD (Fine Particle Dose), MMAD (Mass Median Aerodynamic Diameter), and Throat Deposition as characterized by NGI (Next Generation Impactor). As shown in FIG. 27, budesonide and albuterol demonstrated consistent delivered dose as represented as %LC (percent of label claim) and were stable for twelve months when stored valve down and protected at 25°C/60% RH.

10

**Table 9.** BD, AB, and DSPC Fine Particle Fraction (FPF), Fine Particle Dose (FPD), Mass Median Aerodynamic Diameter (MMAD), and Throat Deposition of BDA-1234ze

Active	FPF, <6.4 $\mu\text{m}$ (%)	FPD, <6.4 $\mu\text{m}$ ( $\mu\text{g}/\text{act}$ )	MMAD ( $\mu\text{m}$ )	Throat Deposition (%)
AB	48	42.5	3.67	36.5
BD	43	35.3	4.18	37.8
DSPC	46	80.0	3.89	77.4

15 **Table 10.** BD and AB Fine Particle Fraction (FPF), Fine Particle Dose (FPD), Mass Median Aerodynamic Diameter (MMAD), and Throat Deposition of BDA-1234ze and BDA-134a formulations as characterized by NGI

Active	Formulation	FPF, <6.4 $\mu\text{m}$ (%)	FPD, <6.4 $\mu\text{m}$ ( $\mu\text{g}/\text{act}$ )	MMAD ( $\mu\text{m}$ )	Throat Deposition (%)
BD	BDA-134a	42	33.0	4.00	38.2
	BDA-1234ze	43	35.3	4.18	37.8
AB	BDA-134a	45	38.4	3.64	38.6
	BDA-1234ze	48	42.5	3.67	36.5

**Table 11.** BD and AB Fine Particle Fraction (FPF), Fine Particle Dose (FPD), Mass Median Aerodynamic Diameter (MMAD), and Throat Deposition Stability Data for BDA-1234ze

Active	Storage	FPF, <6.4 $\mu\text{m}$ (%)	FPD, <6.4 $\mu\text{m}$ ( $\mu\text{g}/\text{act}$ )	MMAD ( $\mu\text{m}$ )	Throat Deposition (%)
BD	Initial	43	35.3	4.18	37.8
	6 month 25°C/60%RH	41	35.1	4.17	41.5
	12 month 25°C /60%RH	40	33.8	4.39	39.9
AB	Initial	48	42.5	3.67	36.5
	6 month 25°C/60%RH	45	42.3	3.70	41.5
	12 month 25°C /60%RH	43	39.1	4.01	39.8

5 In the formulation without phospholipid particles, the two types of active agent particles showed individual deposition distributions, while in the formulation containing phospholipid particles, the two types of active agent particles showed uniform deposition distributions.

10 *Example 6*

Metered dose inhalers containing a dual co-suspension composition comprising glycopyrrolate and formoterol active agent particles were prepared, with each type of active agent particle being provided as a micronized, crystalline API material. The active agent particles were suspended in HFO-1234ze(E) propellant, either with or without phospholipid particles. As shown in **FIG. 28**, the two types of active agent particles and the suspending particles showed a uniform deposition distribution in the formulation containing phospholipid particles.

*Example 7*

Metered dose inhalers containing a triple co-suspension composition comprising glycopyrrolate, budesonide, and formoterol active agent particles were prepared, with each type of active agent particle being provided as a micronized, crystalline API material. The active agent particles were suspended in either HFA-134a or HFO-1234ze(E) propellant, and formulated either with or without phospholipid particles.

The deposition distribution of the formoterol active agent particles was tested at several different environmental humidity (RH) levels, ranging from 0% to 100%. The formoterol active agent particles in the formulations without phospholipid particles showed increased throat and stage 3 deposition in HFO-1234ze(E) as compared to HFA-134a. This difference was not observed, however, in the formulations that included phospholipid particles, which showed similar formoterol deposition distributions in HFO-1234ze(E) (**FIG. 8**, bottom panel) and in HFA-134a (**FIG. 8**, top panel).

The deposition distribution of the budesonide active agent particles was tested at several different environmental humidity (RH) levels, ranging from 0% to 100%. The budesonide deposition distribution in the HFA-134a formulations without phospholipid particles is more sensitive to RH levels than in the HFO-1234ze(E) formulations without phospholipid particles. In the presence of phospholipid particles, both the HFA-134a and HFO-1234ze(E) formulations are more sensitive to RH as compared to the formulations without phospholipid particles, and both formulations showed similar changes to deposition distribution based on RH levels (**FIG. 9**).

The deposition distribution of the glycopyrrolate active agent particles was tested at several different environmental humidity (RH) levels, ranging from 0% to 100%. In the presence of phospholipid particles, both the HFA-134a and HFO-1234ze(E) formulations are more sensitive to RH as compared to the formulations without phospholipid particles, and both formulations showed similar changes to deposition distribution based on RH levels.

*Example 8*

The fine particle fraction (FPF) present in the delivered dose upon actuation of an MDI containing budesonide, formoterol, or glycopyrrolate active agent particles and phospholipid particles was measured following storage of the MDI under various temperature and relative humidity conditions for varied periods of time. (FIGs 5 10A, 10B, 10C)

The fine particle mass (FPM) present in the delivered dose upon actuation of an MDI containing budesonide and phospholipid particles was measured following storage of the MDI under various temperature and relative humidity conditions for varied periods of time. (FIGs 11A, 11B, 11C)

10

*Example 9*

Degradation of budesonide (FIGs 12A, 12B, 12C) and glycopyrrolate (FIGs 13A, 13B, 13C) active agent particles in an MDI canister containing active agent particles and phospholipid particles was measured following storage of the MDI under 15 various temperature and relative humidity conditions for varied periods of time.

*Example 10*

Delivered dose uniformity upon actuation of an MDI containing budesonide active agent particles and phospholipid particles was measured following 20 storage of the MDI under various temperature and relative humidity conditions for varied periods of time. (FIGs 14A, 14B, 14C)

*Example 11*

Metered dose inhalers containing a quadruple co-suspension 25 composition comprising glycopyrrolate, budesonide, formoterol, and roflumilast active agent particles were prepared, with each type of active agent particle being provided as a micronized, crystalline API material. The active agent particles were suspended in HFO-1234ze(E) propellant, and formulated with phospholipid particles. The deposition distribution of each type of active agent particles was tested for a freshly prepared MDI, 30 after three months of storage at 25°C and 75% relative humidity, and after three months of storage at 40°C and 75% relative humidity. The quadruple formulation demonstrates

consistent aerosol distribution for each of the four types of active agent particles, and this distribution is consistent after three months of storage at the tested temperatures and relative humidity levels.

5 *Example 12*

A randomized, single blind, 3-period, 3-treatment, single-dose, crossover study was conducted to assess the relative bioavailability of BGF MDI HFO-1234ze(E) and BGF MDI HFC-152a compared with BGF MDI HFA-134a in healthy subjects.

The investigational medical products include (1) Test Product of  
10 budesonide/glycopyrronium/formoterol (BGF) metered dose inhaler (MDI) formulated with HFO-1234ze(E) propellant and (2) Reference Product of budesonide/glycopyrronium/formoterol (BGF) metered dose inhaler (MDI) formulated with HFA-134a propellant. The indication studied is chronic obstructive pulmonary disease (COPD) and the development phase is Phase 1.

15

STUDY OBJECTIVES:

Primary objective:

To evaluate the relative bioavailabilities between the test formulations and the reference formulation for fixed dose combinations (FDCs) of budesonide,  
20 glycopyrronium, and formoterol when administered as budesonide, glycopyrronium, and formoterol (BGF) metered dose inhaler (MDI) with 3 different propellants.

Secondary objectives:

To determine the pharmacokinetic (PK) parameters of BGF when administered as 3 different propellant formulations. To assess the safety and  
25 tolerability of a combination of BGF when administered as single doses in 3 different propellant formulations in healthy subjects.

STUDY DESIGN:

This study was a randomized, single blind, 3-period, 3-treatment, single-  
30 dose, single-center, crossover study. The study included the assessment of PK properties of BGF MDI formulated with 3 different propellants: hydrofluoroolefin

(HFO-1234ze(E)) - Treatment A (test), hydrofluorocarbon (HFC-152a) - Treatment B (test), and hydrofluoroalkane (HFA-134a) - Treatment C (reference).

The study comprised of:

- Screening period: up to 28 days prior to first dosing.
- 5 • Three treatment periods of maximum 3 days each: subjects were resident from the morning of the day before the first dosing with BGF MDI (Day -1) in Treatment Period 1, throughout all treatment and washout periods up to discharge on Day 2 of Treatment Period 3.
- Follow-up: within 3 to 7 days after the last administration of BGF  
10 MDI. There was a washout period of 3 to 7 days between each dose. Each subject received 3 single-dose treatments of BGF MDI (1 dose HFO-1234ze(E) [Treatment A]; 1 dose HFC-152a [Treatment B] and 1 dose HFA-134a [Treatment C]), following an overnight fast of at least 8 hours.

#### 15 MAIN INCLUSION CRITERIA:

Healthy, non-smoking male subjects aged 18 to 60 years with suitable veins for cannulation or repeated venepuncture. Subjects had to have a body mass index (BMI) between 18 and 30 kg/m<sup>2</sup>, inclusive and weigh at least 50 kg and no more than 100 kg, inclusive. Subjects had to have a forced expiratory volume in one second  
20 (FEV1)  $\geq$  80% of the predicted value regarding age, height, and ethnicity at the screening visit.

#### INVESTIGATIONAL MEDICINAL PRODUCTS:

Treatment A (test): BGF MDI HFO-1234ze(E) with  
25 strength/concentrations of 160/7.2/4.8  $\mu$ g per actuation.

Treatment B (test): BGF MDI HFC-152a with strength/concentrations of 160/7.2/4.8  $\mu$ g per actuation.

Treatment C (reference): BGF MDI HFA-134a with  
strength/concentrations of 160/7.2/4.8  $\mu$ g per actuation.

30

#### DURATION OF STUDY:

Each subject was to be involved in the study for up to 53 days.

#### TREATMENT COMPLIANCE:

Dosing took place at the Parexel Early Phase Clinical Unit in Los Angeles. The administration of all investigational medicinal products (IMPs) was recorded in Parexel's electronic source data capturing and information management system (CLINBASE™). Compliance was assured by direct supervision and witnessing of IMP administration.

#### 10 CRITERIA FOR EVALUATION:

##### Pharmacokinetic Parameters:

- Primary PK parameters: C<sub>max</sub>, AUC<sub>inf</sub>, and AUC<sub>last</sub> for test and reference treatment.
- Secondary PK parameters: t<sub>max</sub>, t<sub>1/2λz</sub>, MRT, λ<sub>z</sub>, CL/F, V<sub>z</sub>/F, TRC<sub>max</sub>, TRAUC<sub>inf</sub>, and TRAUC<sub>last</sub>.

##### Safety Variables:

- Adverse events (AEs)/Serious adverse events (SAEs).
- Vital signs (systolic and diastolic blood pressure, pulse rate, body temperature, oxygen saturation, and respiratory rate).
- Twelve-lead safety and digital electrocardiograms (ECGs) as well as cardiac telemetry
- Physical examination.
- Laboratory assessments (hematology, clinical chemistry and urinalysis)
- Spirometry.
- Taste assessment.

#### STATISTICAL METHODS:

##### Determination of Sample Size:

This was a pilot PK study to determine the relative bioavailabilities between 2 test formulations of BGF MDI compared with the conventional formulation. Therefore, no sample size calculation was performed.

It was expected that 48 healthy subjects (number of subjects were increased from 24 to 48 as per protocol amendment 2 to account for replacement subjects due to a dosing deviation involving the first 23 subjects) were to be randomized to a 6 sequence Williams design for 3 periods and 3 treatments: ABC, BCA, CAB, ACB, BAC and CBA, in order to ensure at least 20 evaluable subjects at the end of the last treatment period.

Subjects were considered evaluable if they had an evaluable PK profile, i.e., (1) received active treatment, (2) did not significantly violate protocol inclusion or exclusion criteria, or deviate significantly from the protocol, and (3) did not have unavailable or incomplete data which may have influenced the PK analysis,

#### Presentation and Analysis of Pharmacokinetic Data:

All PK concentrations, parameter summaries and statistical analyses were presented for the PK Analysis Set, unless otherwise specified. The PK concentration and parameter listings were presented for the Safety Analysis Set and included all reportable individual PK results. Individual PK concentration and parameter data for any subjects not included in the PK Analysis Set or excluded from the descriptive summary tables, figures and/or inferential statistical analyses were included in the listings and flagged with an appropriate footnote.

The test treatments, Treatments A and B (BGF MDI HFO and BGF MDI HFC, respectively), were separately compared to the reference treatment, Treatment C (BGF MDI HFA), for each analyte. The statistical analyses were performed using a linear mixed effects analysis of variance model, using the natural logarithm of C<sub>max</sub>, AUC<sub>inf</sub>, and AUC<sub>last</sub> as the response variables, with sequence, and period, treatment as fixed effects and subject nested within sequence as random effect. Transformed back from the logarithmic scale, geometric means together with the intra-subject coefficient of variation confidence intervals (CIs) (2-sided 95%) for C<sub>max</sub>, AUC<sub>inf</sub>, and AUC<sub>last</sub> were estimated and presented. In addition, ratios of geometric means together with CIs (2-sided 90%) were estimated and presented.

Additionally, the median difference in untransformed tmax between the test treatments and the reference treatment for each analyte and the corresponding 90% CIs for the median differences, for each analyte were calculated using the non parametric Hodges Lehmann method.

5           Presentation and Analysis of Safety and Eligibility Data:

Safety data (scheduled and unscheduled) were presented in the data listings. Continuous variables were summarized using descriptive statistics (n, mean, standard deviation [SD], minimum, median, maximum) by treatment. Categorical variables were summarized in frequency tables (frequency and proportion) by  
10 treatment, if applicable. The analysis of the safety variables was based on the Safety Analysis Set.

Adverse events were summarized by Preferred Term (PT) and System Organ Class (SOC) using Medical Dictionary for Regulatory Activities (MedDRA) vocabulary. Furthermore, listings of SAEs and AEs that led to withdrawal were made  
15 and the number of subjects who had any AEs, SAEs, AEs that led to withdrawal, and AEs with severe intensity were summarized. Adverse events that occurred before dosing were reported separately.

Tabulations and listings of data for vital signs, clinical laboratory tests, digital ECGs, and 12-lead safety ECGs (listings only), telemetry (listings only), and  
20 spirometry were presented. Results from the taste assessment were presented separately in listings only. Any new or aggravated clinically relevant abnormal medical physical examination finding compared to the baseline assessment was reported as an AE. Data were summarized for the observed values at each scheduled assessment, together with the corresponding changes from the baseline when baseline was defined. Clinical  
25 laboratory data were reported in the units provided by the clinical laboratory for the Safety Review Committee (SRC) meeting, and in Système International (SI) units in the Clinical Study Report (CSR).

Out of range values for safety laboratory assessments were flagged in individual listings as well as summarized descriptively using agreed standard reference  
30 ranges and/or extended reference ranges (e.g., AstraZeneca, program, or laboratory ranges).

#### PROTOCOL DEVIATIONS:

In total, important protocol deviations were reported for 26 (55.3%) subjects during the study:

5                   • For Treatment A (HFO propellant): 23 (48.9%) subjects were reported with other important protocol deviations (subject did not self dose with the inhaler as outlined in the protocol. Nurse administered the dose).

                    • For Treatment B (HFC propellant): 23 (48.9%) subjects were reported with other important protocol deviations (subject did not self dose with the inhaler as  
10                   outlined in the protocol. Nurse administered the dose) and 2 (4.3%) subjects did not receive the full dose expected due to issues during inhalation.

                    • For Treatment C (HFA propellant): 23 (48.9%) subjects were reported with other important protocol deviations (subject did not self dose with the inhaler as  
15                   outlined in the protocol. Nurse administered the dose) and 1 (2.1%) subject did not receive the full dose expected due to issues during inhalation.

The number of subjects were increased from 24 to 48 as per protocol amendment 2 to account for replacement subjects due to a dosing deviation involving the first 23 subjects.

20                   There were 23 subjects excluded from the PK Analysis Set due to protocol deviations reported. No important protocol deviations related to COVID-19 were reported during the study.

#### PHARMACOKINETIC RESULTS:

25                   • Systemic exposure to budesonide from BGF MDI HFO was comparable to BGF MDI HFA, with GMRs and 90% CIs of 111.7% (91.01%, 137.1%), 104.7% (91.95%, 119.2%) and 107.2% (94.53%, 121.9%) for C<sub>max</sub>, AUC<sub>inf</sub> and AUC<sub>last</sub>, respectively

30                   • Systemic exposure to glycopyrronium from BGF MDI HFO was comparable to BGF MDI HFA, with GMRs and 90% CIs of 108.3% (85.50%, 137.3%) and 106.1% (86.18%, 130.6%) for C<sub>max</sub> and AUC<sub>last</sub>, respectively.

• Systemic exposure to formoterol from BGF MDI HFO was comparable to BGF MDI HFA, with GMRs and 90% CIs of 109.1% (97.02%, 122.7%), 96.00% (70.33%, 131.0%) and 98.13% (86.44%, 111.4%) for C<sub>max</sub>, AUC<sub>inf</sub> and AUC<sub>last</sub>, respectively.

5

#### SAFETY RESULTS:

• There were no deaths, SAEs, or AEs that led to the discontinuation of the IMP reported during this study.

• No new safety signals were observed, no clinically relevant trends were  
10 observed for vital signs, physical examination, laboratory results, spirometry and taste assessment, and no abnormal clinically significant 12-lead safety and digital ECG, as well as cardiac telemetry findings were reported.

• The combination of budesonide, glycopyrronium, and formoterol when administered as single doses in 3 different propellant formulations demonstrated an  
15 acceptable safety profile and was well tolerated in the studied population.

In view of this clinical study, systemic exposure to budesonide, glycopyrronium, and formoterol was similar for BGF MDI HFO-1234ze(E) compared with the reference product, BGF MDI HFA-134a. There was no indication of  
20 meaningful differences between the products in this taste assessment. The combination of budesonide, glycopyrronium, and formoterol when administered as single doses in HFO-1234ze(E) and HFA-134a formulations demonstrated an acceptable safety profile and was well tolerated in the studied population.

25

#### *Example 13*

**FIG. 38** depicts the aerosol particle size distribution (aPSD) measured by a Next Generation Impactor (NGI), expressed as a percent of the total recovered mass, for budesonide (BD) and formoterol fumarate (FF) active agent particles actuated from an MDI containing a dual fixed dose combination co-suspension of budesonide  
30 and formoterol fumarate active agent particles suspended in HFA-134a (formulation referred to as BFF-134a) or HFO-1234ze(E) (formulation referred to as BFF-1234ze)

propellant with phospholipid suspending particles. The profiles demonstrate a similar aerosol distribution between HFA-134a and HFO-1234ze(E) for both active agent particles.

**FIG. 39** depicts the aPSD measured by NGI, expressed as a percent of the total recovered mass, for budesonide (BD) and formoterol fumarate (FF) active agent particles actuated from an MDI containing a triple fixed dose combination co-suspension of budesonide and formoterol fumarate active agent particles suspended in HFA-134a (formulation referred to as BFF crystal-134a) or HFO-1234ze(E) (formulation referred to as BFF crystal-1234ze) propellant without phospholipid suspending particles. The profiles demonstrate unique aerosol distributions between HFA-134a and HFO-1234ze(E) for both active agent particles.

Table 12 provides a summary of the fine particle fraction, <6.4  $\mu\text{m}$  (FPF), fine particle dose, <6.4  $\mu\text{m}$  (FPD), mass median aerodynamic diameter (MMAD), and throat deposition of budesonide and formoterol fumarate calculated from the NGI datasets of BFF-134a, BFF-1234ze, BFF crystal-134a, and BFF crystal-1234ze.

**Table 12.** BD and FF Fine Particle Fraction (FPF), Fine Particle Dose (FPD), Mass Median Aerodynamic Diameter (MMAD), and Throat Deposition of BFF-134a, BFF-1234ze, BFF crystal-134a, and BFF crystal-1234ze

Formulation	Active	FPF, <6.4 $\mu\text{m}$ (%)	FPD, <6.4 $\mu\text{m}$ ( $\mu\text{g}/\text{act}$ )	MMAD ( $\mu\text{m}$ )	Throat Deposition (%)
BFF-134a	BD	54	83.3	3.45	33.6
	FF	56	2.7	3.24	32.1
BFF-1234ze	BD	50	82.6	3.68	35.2
	FF	53	2.5	3.47	32.9
BFF crystal-134a	BD	67	163.4	3.01	24.3
	FF	53	3.8	3.85	34.7
BFF crystal-1234ze	BD	62	93.1	2.80	29.6
	FF	58	2.6	3.18	30.1

*Example 14*

**FIG. 40** depicts the aerosol particle size distribution (aPSD) measured by a Next Generation Impactor (NGI), expressed as a percent of the total recovered mass, for budesonide (BD), glycopyrronium (GP), and formoterol fumarate (FF) active agent particles actuated from an MDI containing a triple fixed dose combination co-suspension of budesonide, glycopyrronium, and formoterol fumarate active agent particles suspended in HFA-134a (formulation referred to as BGF-134a) or HFO-1234ze(E) (formulation referred to as BGF-1234ze) propellant with phospholipid suspending particles. The profiles demonstrate a similar aerosol distribution between HFA-134a and HFO-1234ze(E) for all active agent particles.

**FIG. 41** depicts the aPSD measured by NGI, expressed as a percent of the total recovered mass, for budesonide (BD), glycopyrronium (GP), and formoterol fumarate (FF) active agent particles actuated from an MDI containing a triple fixed dose combination co-suspension of budesonide, glycopyrronium, and formoterol fumarate active agent particles suspended in HFA-134a (formulation referred to as BGF crystal-134a) or HFO-1234ze(E) (formulation referred to as BGF crystal-1234ze) propellant without phospholipid suspending particles. The profiles demonstrate unique aerosol distributions between HFA-134a and HFO-1234ze(E) for all active agent particles.

Table 13 provides a summary of the fine particle fraction, <6.4  $\mu\text{m}$  (FPF), fine particle dose, <6.4  $\mu\text{m}$  (FPD), mass median aerodynamic diameter (MMAD), and throat deposition of budesonide, glycopyrronium, and formoterol fumarate calculated from the NGI datasets of BGF-134a, BGF-1234ze, BGF crystal-134a, and BGF crystal-1234ze.

**Table 13.** BD, GP, and FF fine particle fraction, <6.4  $\mu\text{m}$  (FPF), fine particle dose, <6.4  $\mu\text{m}$  (FPD), mass median aerodynamic diameter (MMAD), and throat deposition of BGF-134a, BGF-1234ze, BGF crystal-134a, and BGF crystal-1234ze

Formulation	Active	FPF, <6.4 $\mu\text{m}$ (%)	FPD, <6.4 $\mu\text{m}$ ( $\mu\text{g}/\text{act}$ )	MMAD ( $\mu\text{m}$ )	Throat Deposition (%)
BGF-134a	BD	56	93.9	3.83	3.33
	GP	59	4.5	3.68	3.15
	FF	59	3.0	3.69	3.18

BGF-1234ze	BD	52	82.4	3.87	3.61
	GP	54	3.8	3.70	3.50
	FF	54	2.6	3.73	3.48
BGF crystal-134a	BD	64	107.2	3.32	2.69
	GP	71	5.2	3.50	2.61
	FF	66	3.3	4.10	2.90
BGF crystal-1234ze	BD	61	179.2	3.32	3.32
	GP	70	8.2	3.50	3.51
	FF	52	4.7	4.10	4.10

The various embodiments described above can be combined to provide further embodiments. All of the U.S. patents, U.S. patent application publications, U.S. patent applications, foreign patents, foreign patent applications and non-patent publications referred to in this specification and/or listed in the Application Data Sheet are incorporated herein by reference, in their entirety, unless specified otherwise herein. Aspects of the embodiments can be modified, if necessary to employ concepts of the various patents, applications and publications to provide yet further embodiments.

These and other changes can be made to the embodiments in light of the above-detailed description. In general, in the following claims, the terms used should not be construed to limit the claims to the specific embodiments disclosed in the specification and the claims, but should be construed to include all possible embodiments along with the full scope of equivalents to which such claims are entitled. Accordingly, the claims are not limited by the disclosure.

## CLAIMS

1. A pharmaceutical composition deliverable from a metered dose inhaler, the pharmaceutical composition comprising:
  - a plurality of a first species of active agent particle;
  - a plurality of a second species of active agent particle;
  - a plurality of a third species of active agent particle;
  - a plurality of a fourth species of active agent particle;
  - a plurality of phospholipid particles comprising perforated microstructures; and
  - a pharmaceutically acceptable propellant;wherein the first, second, third and fourth species of active agents are each independently selected from a long-acting muscarinic antagonist (LAMA), a long-acting  $\beta$ -agonists (LABA), a short-acting beta-agonists (SABA), an inhaled corticosteroid (ICS), and a non-corticosteroid anti-inflammatory agent.
  
2. The pharmaceutical composition according to claim 2, wherein:
  - the LAMA is selected from glycopyrrolate, dexpirronium, tiotropium, tropium, aclidinium, umeclidinium, and darotroprum; or a pharmaceutically acceptable salt or solvate thereof;
  - the LABA is selected from bambuterol, clenbuterol, formoterol, salmeterol, carmoterol, milveterol, indacaterol, vilanterol, and saligenin- or indole-containing and adamantyl-derived  $\beta$ <sub>2</sub> agonists; or a pharmaceutically acceptable salt or solvate thereof;
  - the SABA is selected from bitolterol, carbuterol, fenoterol, hexoprenaline, isoprenaline (isoproterenol), levosalbutamol, orciprenaline (metaproterenol), pirbuterol, procaterol, rimiterol, albuterol (salbutamol), terbutaline, tulobuterol, reproterol, and epinephrine; or a pharmaceutically acceptable salt or solvate thereof;
  - the ICS is selected from beclomethasone, budesonide, ciclesonide, flunisolide, fluticasone, methylprednisolone, mometasone, prednisone and triamcinolone; or a pharmaceutically acceptable salt or solvate thereof; and
  - the non-corticosteroid anti-inflammatory agent is selected from roflumilast, apremilast, crisaborole, ruxolitinib, tofacitinib, oclacitinib, baricitinib, peficitinib, fedratinib, and upadacitinib; or a pharmaceutically acceptable salt or solvate thereof.

3. The pharmaceutical composition according to claim 1 or 2, wherein the LAMA is glycopyrrolate or a pharmaceutically acceptable salt or solvate thereof.
4. The pharmaceutical composition according to any one of claims 1 to 3, wherein the LABA is formoterol or a pharmaceutically acceptable salt or solvate thereof.
5. The pharmaceutical composition according to any one of claims 1 to 4, wherein the SABA is albuterol or a pharmaceutically acceptable salt or solvate thereof.
6. The pharmaceutical composition according to any one of claims 1 to 5, wherein the ICS is budesonide or a pharmaceutically acceptable salt or solvate thereof.
7. The pharmaceutical composition according to any one of claims 1 to 6, wherein the non-corticosteroid anti-inflammatory agent is roflumilast or a pharmaceutically acceptable salt or solvate thereof.
8. The pharmaceutical composition according to any one of claims 1 to 7, wherein the LAMA is present at a concentration in the range of about 0.04 mg/mL to about 2.25 mg/mL.
9. The pharmaceutical composition according to any one of claims 1 to 8, wherein the LABA is present at a concentration in the range of about 0.01 mg/mL to about 1 mg/mL.
10. The pharmaceutical composition according to any one of claims 1 to 9, wherein the ICS is present at a concentration in the range of about 0.1 mg/mL to about 20 mg/mL.
11. The pharmaceutical composition according to any one of claims 1 to 10, wherein the SABA is present at a concentration in the range of about 0.1 mg/mL to about 20 mg/mL.

12. The pharmaceutical composition according to any one of claims 1 to 11, wherein the non-corticosteroid anti-inflammatory agent is present at a concentration in the range of about 0.03 mg/mL to about 3 mg/mL

13. The pharmaceutical composition according to any one of claims 1 to 12, wherein the perforated microstructures comprise 1,2-Distearoyl-sn-glycero-3-phosphocholine (DSPC) and calcium chloride.

14. The pharmaceutical composition according to any one of claims 1 to 13, wherein the phospholipid particles are present at a concentration in the range of about 0.1 mg/mL to about 10 mg/mL.

15. The pharmaceutical composition according to any one of claims 1 to 14, comprising:

- a plurality of glycopyrrolate particles;
- a plurality of formoterol particles;
- a plurality of budesonide particles;
- a plurality of roflumilast particles; and
- a plurality of phospholipid particles comprising perforated microstructures; and
- a pharmaceutically acceptable propellant.

16. The pharmaceutical composition according to any one of the preceding claims, wherein the glycopyrrolate particles are in the propellant at a concentration sufficient to provide a delivered dose of glycopyrrolate per actuation of the metered dose inhaler selected from between about 5 µg and about 50 µg per actuation, between about 2 µg and about 25 µg per actuation, and between about 6 µg and about 15 µg per actuation.

17. The pharmaceutical composition according to any one of the preceding claims, wherein the glycopyrrolate particles comprise micronized and crystalline glycopyrronium bromide.

18. The pharmaceutical composition according to any one of the preceding claims, wherein the formoterol particles are included in the composition at a concentration

sufficient to provide a delivered dose of formoterol selected from between about 1  $\mu\text{g}$  and about 30  $\mu\text{g}$ , between about 0.5  $\mu\text{g}$  and about 10  $\mu\text{g}$ , between about 2  $\mu\text{g}$  and 5  $\mu\text{g}$ , between about 3  $\mu\text{g}$  and about 10  $\mu\text{g}$ , between about 5  $\mu\text{g}$  and about 10  $\mu\text{g}$ , and between 3  $\mu\text{g}$  and about 30  $\mu\text{g}$  per actuation of the metered dose inhaler.

19. The pharmaceutical composition according to any one of the preceding claims, wherein the formoterol particles comprise micronized and crystalline formoterol fumarate.

20. The pharmaceutical composition according to any one of the preceding claims, wherein the budesonide particles are included in the composition at a concentration sufficient to provide a delivered dose of budesonide selected from between about 50  $\mu\text{g}$  and about 400  $\mu\text{g}$ , between about 20  $\mu\text{g}$  and about 600  $\mu\text{g}$ , between about 30  $\mu\text{g}$  and 100  $\mu\text{g}$ , between about 50  $\mu\text{g}$  and about 200  $\mu\text{g}$ , and between about 150  $\mu\text{g}$  and about 350  $\mu\text{g}$  per actuation of the metered dose inhaler.

21. The pharmaceutical composition according to any one of the preceding claims, wherein the budesonide particles comprise micronized budesonide.

22. The pharmaceutical composition according to any one of the preceding claims, wherein the roflumilast particles comprise micronized and crystalline roflumilast.

23. The pharmaceutical composition according to any one of the preceding claims, wherein the roflumilast particles are included in the composition at a concentration sufficient to provide a delivered dose of budesonide selected from between about 1  $\mu\text{g}$  and about 100  $\mu\text{g}$ , about 5  $\mu\text{g}$  and about 80  $\mu\text{g}$ , about 5  $\mu\text{g}$  and about 50  $\mu\text{g}$ , about 5  $\mu\text{g}$  and about 25  $\mu\text{g}$ , about 10  $\mu\text{g}$  and 25  $\mu\text{g}$ , about 50  $\mu\text{g}$  and about 400  $\mu\text{g}$ , between about 20  $\mu\text{g}$  and about 600  $\mu\text{g}$ , between about 30  $\mu\text{g}$  and 100  $\mu\text{g}$ , between about 50  $\mu\text{g}$  and about 200  $\mu\text{g}$ , and between about 150  $\mu\text{g}$  and about 350  $\mu\text{g}$  per actuation of the metered dose inhaler.

24. The pharmaceutical composition according to any one of the preceding claims, wherein the phospholipid particles are included in the composition at a concentration

sufficient to provide a delivered dose of the phospholipid particles selected from between about 50 µg and about 400 µg.

25. The pharmaceutical composition according to any of claims 1 to 24, wherein the pharmaceutically acceptable propellant is selected from HFA, HFC, HFO, and a combination thereof.

26. A metered dose inhaler comprising a canister with an outlet valve including an actuator for dispensing a metered amount of a pharmaceutical composition according to any one of claims 1 through 25, wherein the canister contains the pharmaceutical composition.

27. The metered dose inhaler according to claim 26, wherein the outlet valve comprises a neck gasket and at least one seat gasket; and the neck gasket or the at least one seat gasket is composed of bromobutyl material.

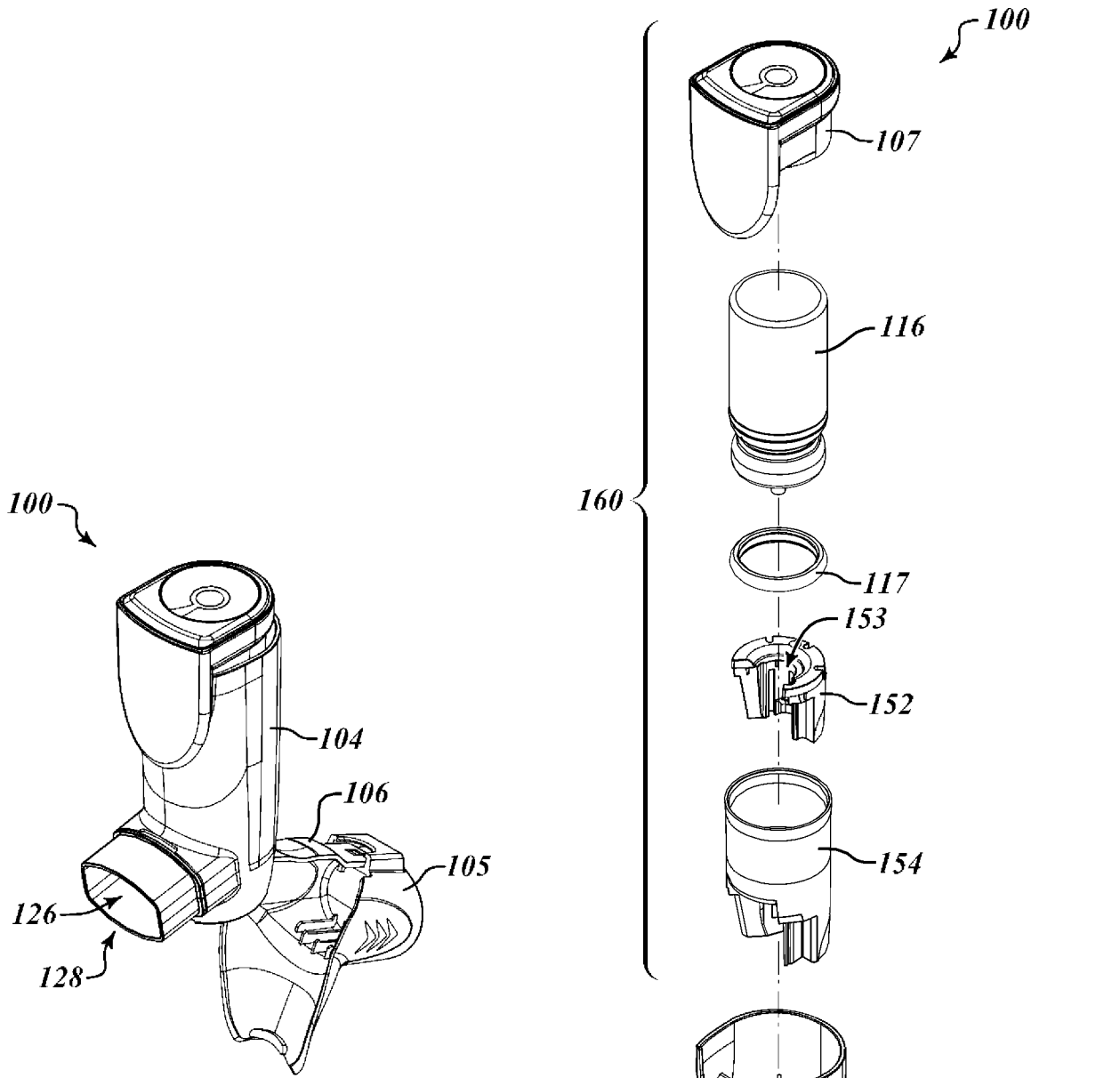
28. The metered dose inhaler according to claim 26 or 27, exhibiting less than about 10%, 9%, 8%, 7%, 6%, or 5% reduced shot weight per actuation throughout emptying of the canister.

29. The metered dose inhaler according to any one of claims 26 to 28, exhibiting less than about 1.0%, 0.5%, 0.4%, 0.3%, 0.2%, or 0.1% weight loss at 25°C/60% RH per year.

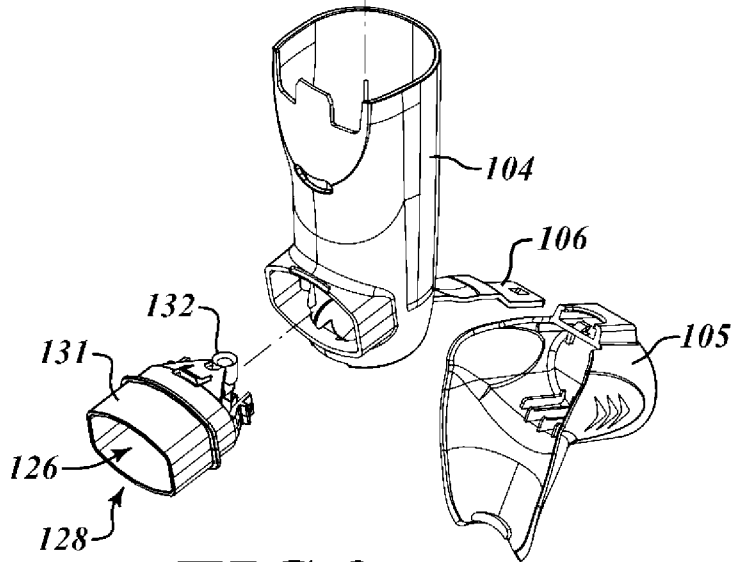
30. The metered dose inhaler according to any one of claims 26 to 29, which exhibits a delivered dose uniformity (DDU) for the pharmaceutical formulation selected from a DDU of  $\pm 20\%$ , or better, a DDU of  $\pm 15\%$ , or better, and a DDU of  $\pm 10\%$ , or better, throughout emptying of the canister.

31. A method of treating a pulmonary disease or disorder in a patient, comprising administering a pharmaceutical composition according to any one of claims 1 to 25 to the patient by actuating a metered dose inhaler; wherein the metered dose inhaler contains the pharmaceutical composition.

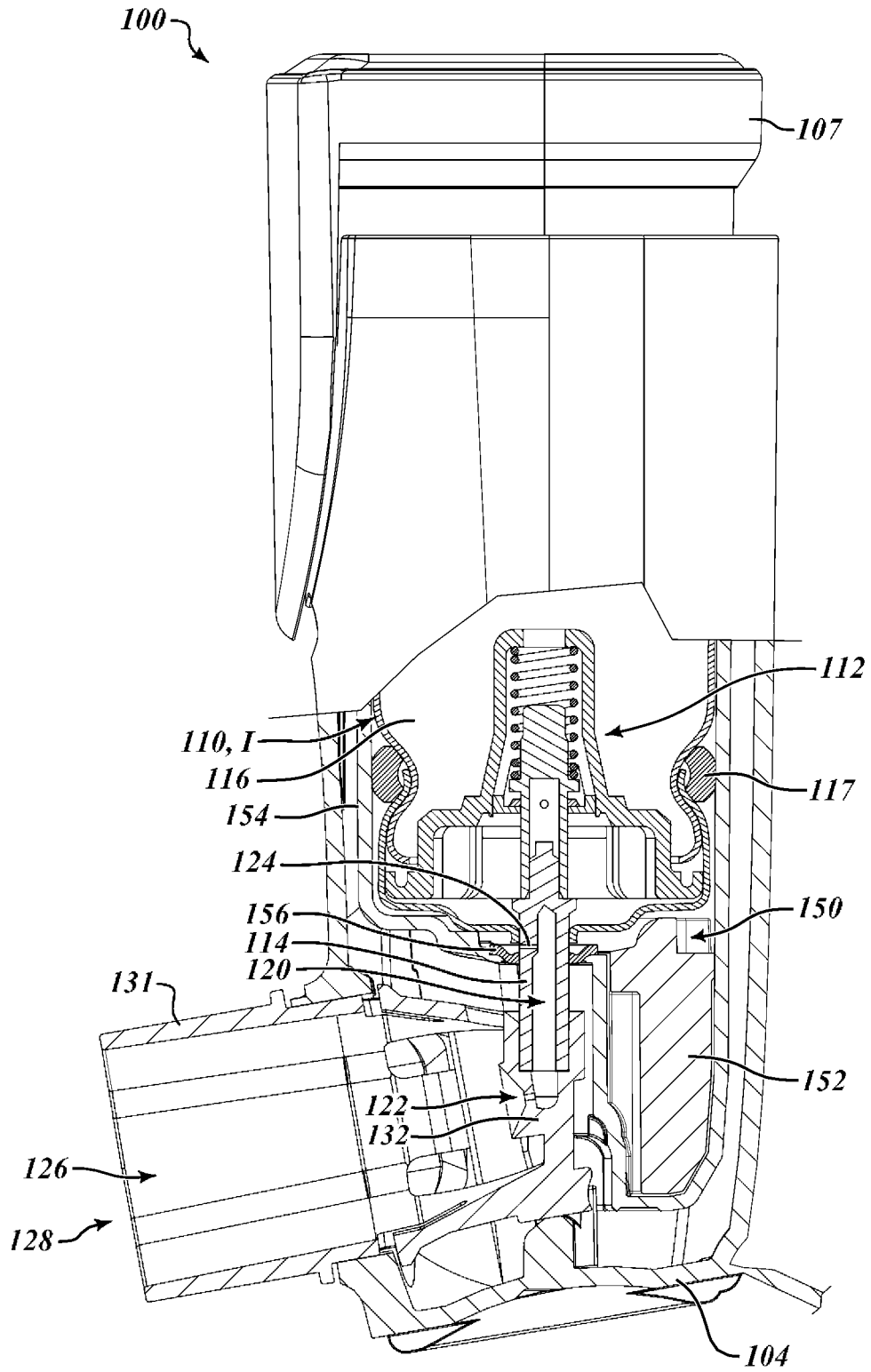
32. The method according to claim 31, wherein the pulmonary disease or disorder is asthma or COPD.
33. The method according to claim 31 or 32, wherein the metered dose inhaler is described according to any one of the claims 21 to 25.
34. The pharmaceutical composition according to any one of claims 1 to 25 for use in the manufacture of a medicament for the treatment of a pulmonary disease or disorder.
35. The pharmaceutical composition according to any one of claims 1 to 25 for use in the treatment of a pulmonary disease or disorder.



**FIG. 1**

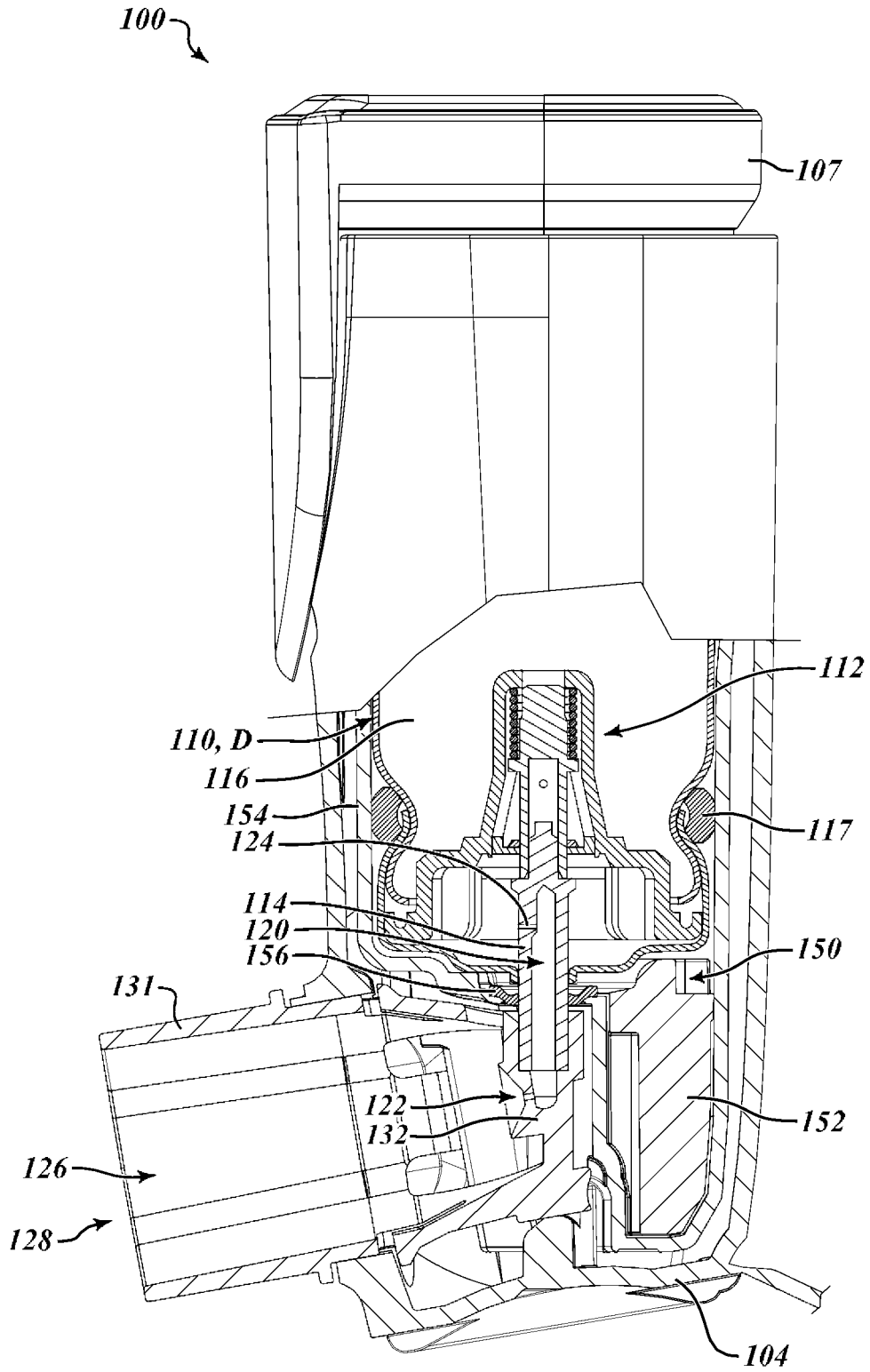


**FIG. 2**



**FIG. 3A**

3/63



**FIG. 3B**

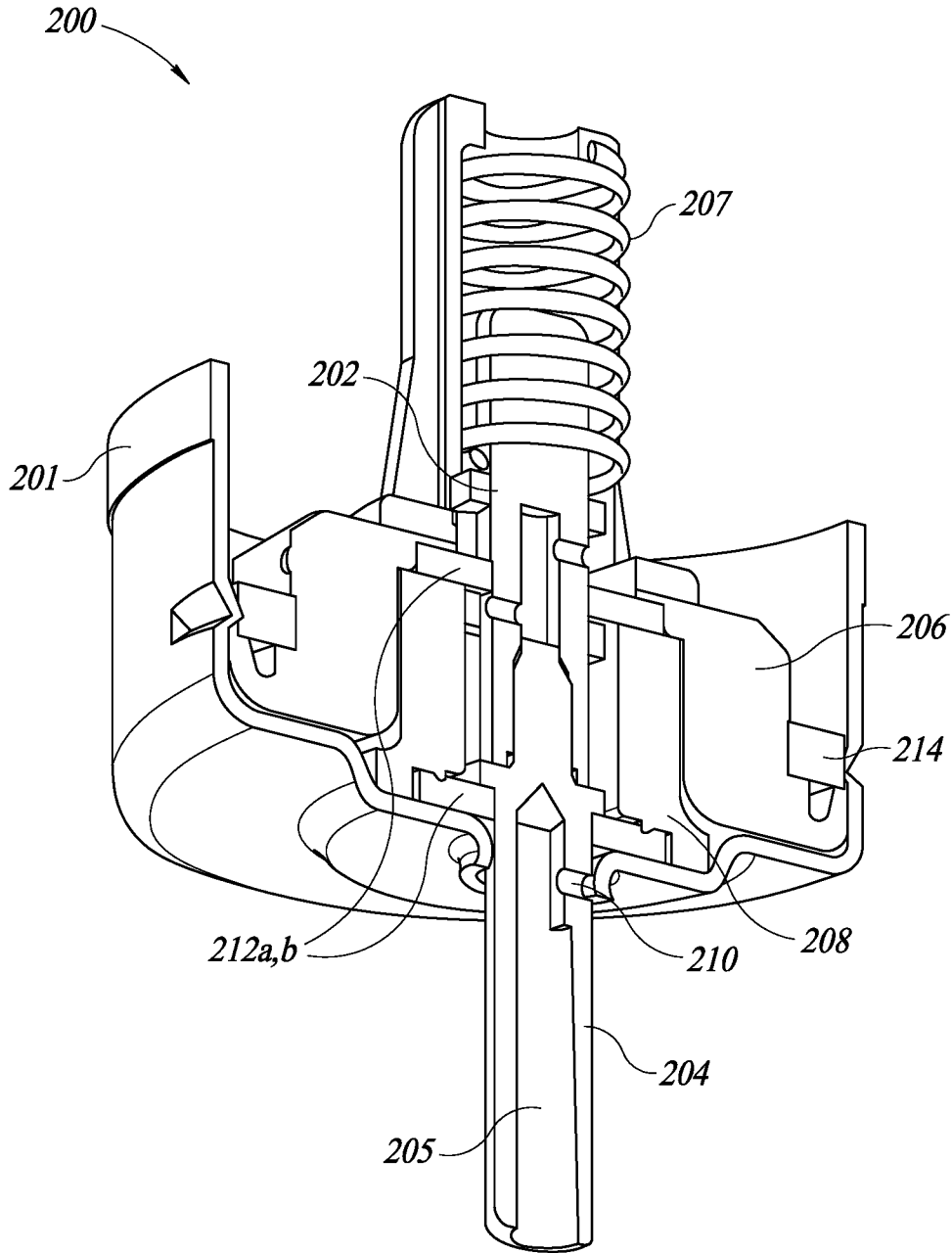
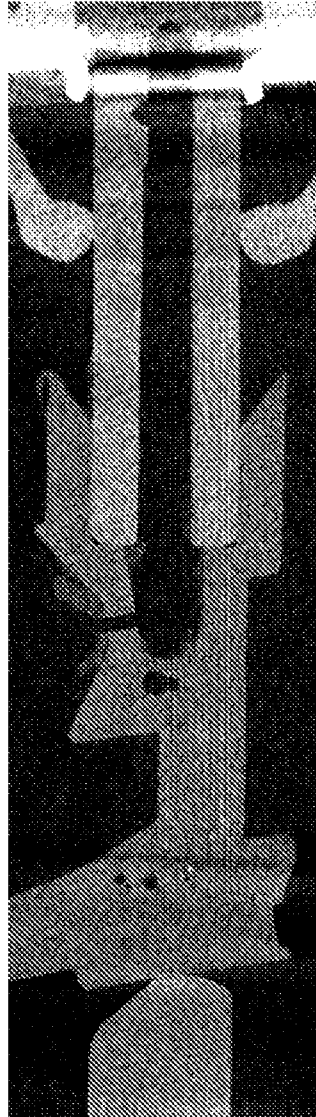


FIG. 4

**5/63**



***FIG. 5***



7/63

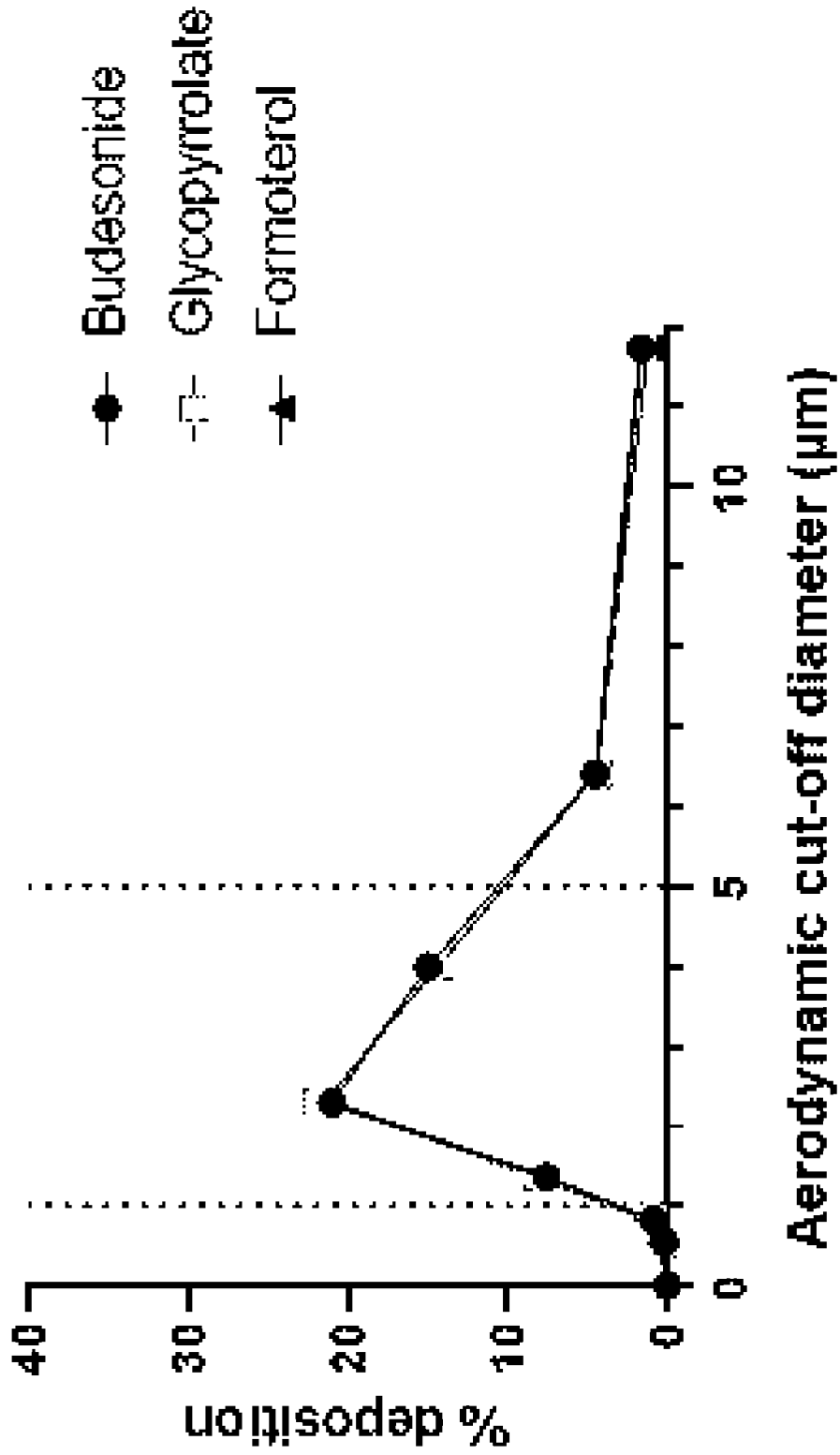
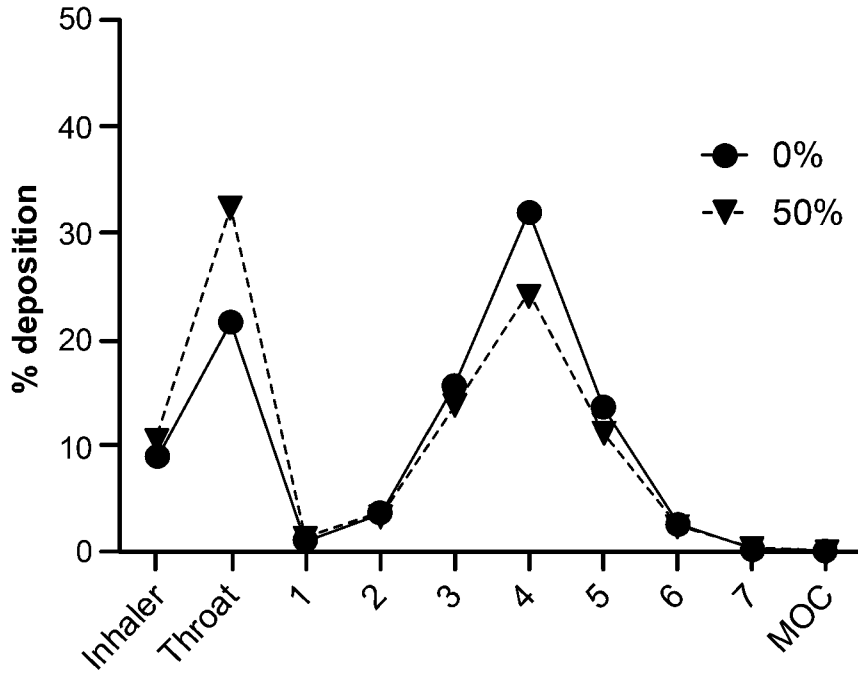


FIG. 7

8/63

HFA-134a propellant



HFO-1234ze propellant

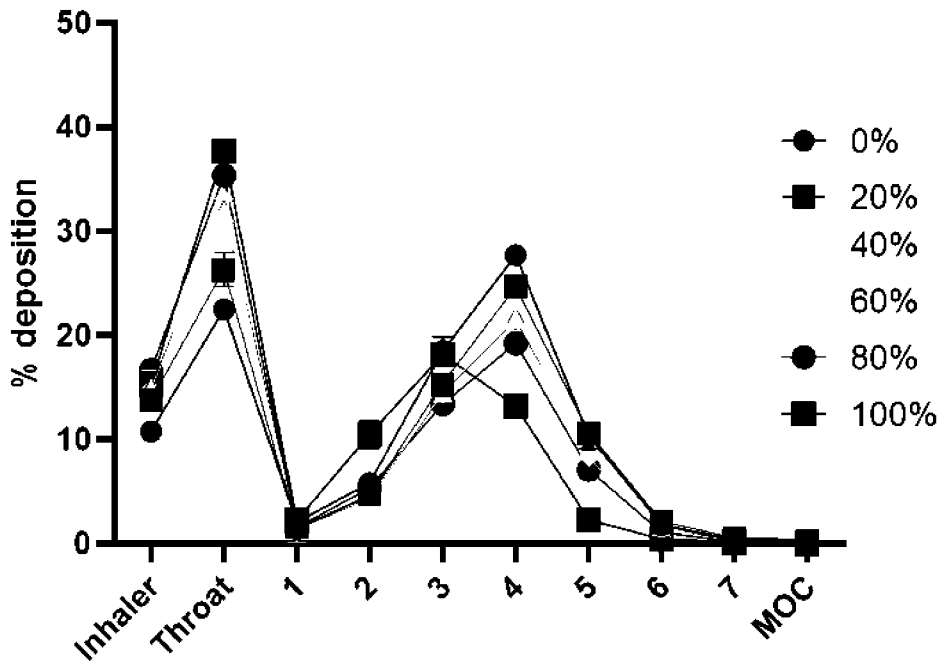
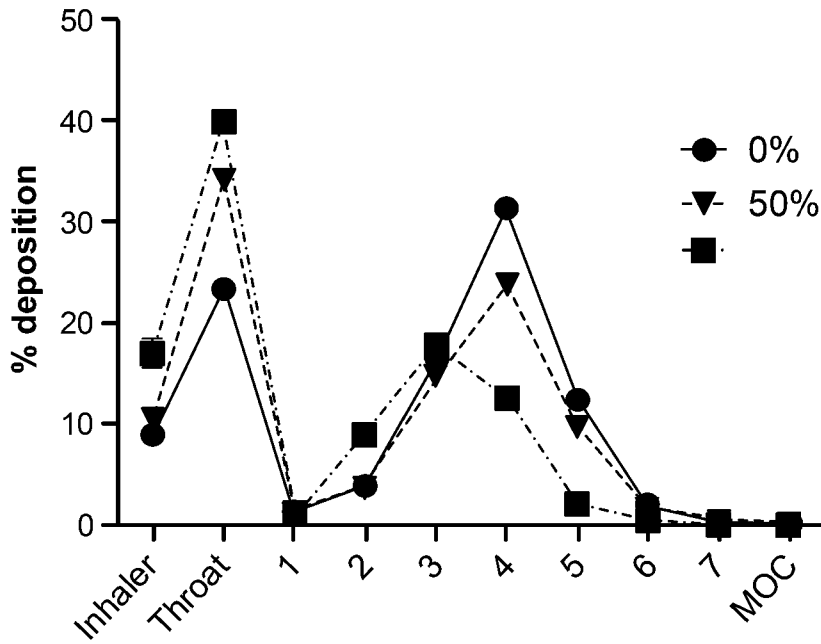


FIG. 8

9/63

HFA-134a propellant



HFO-1234ze propellant

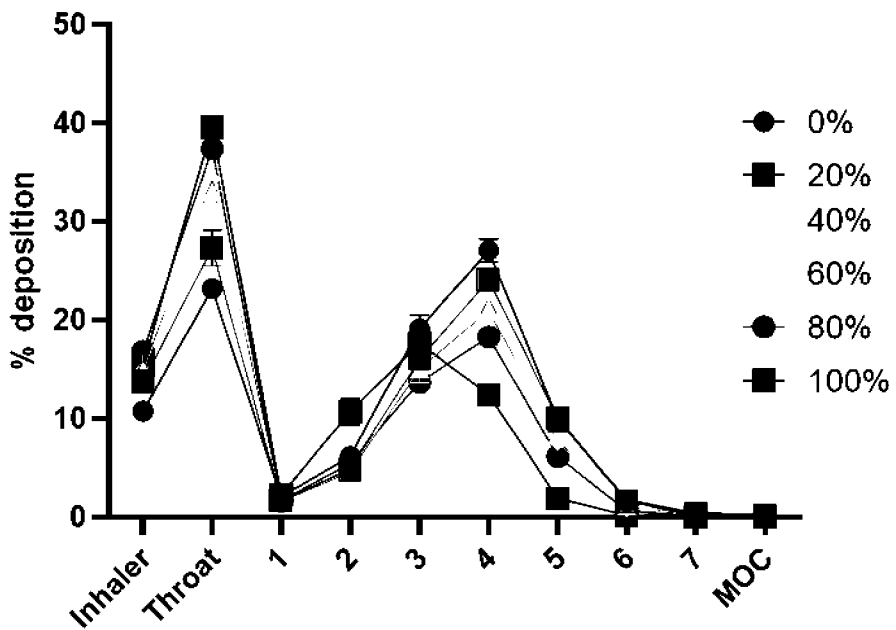
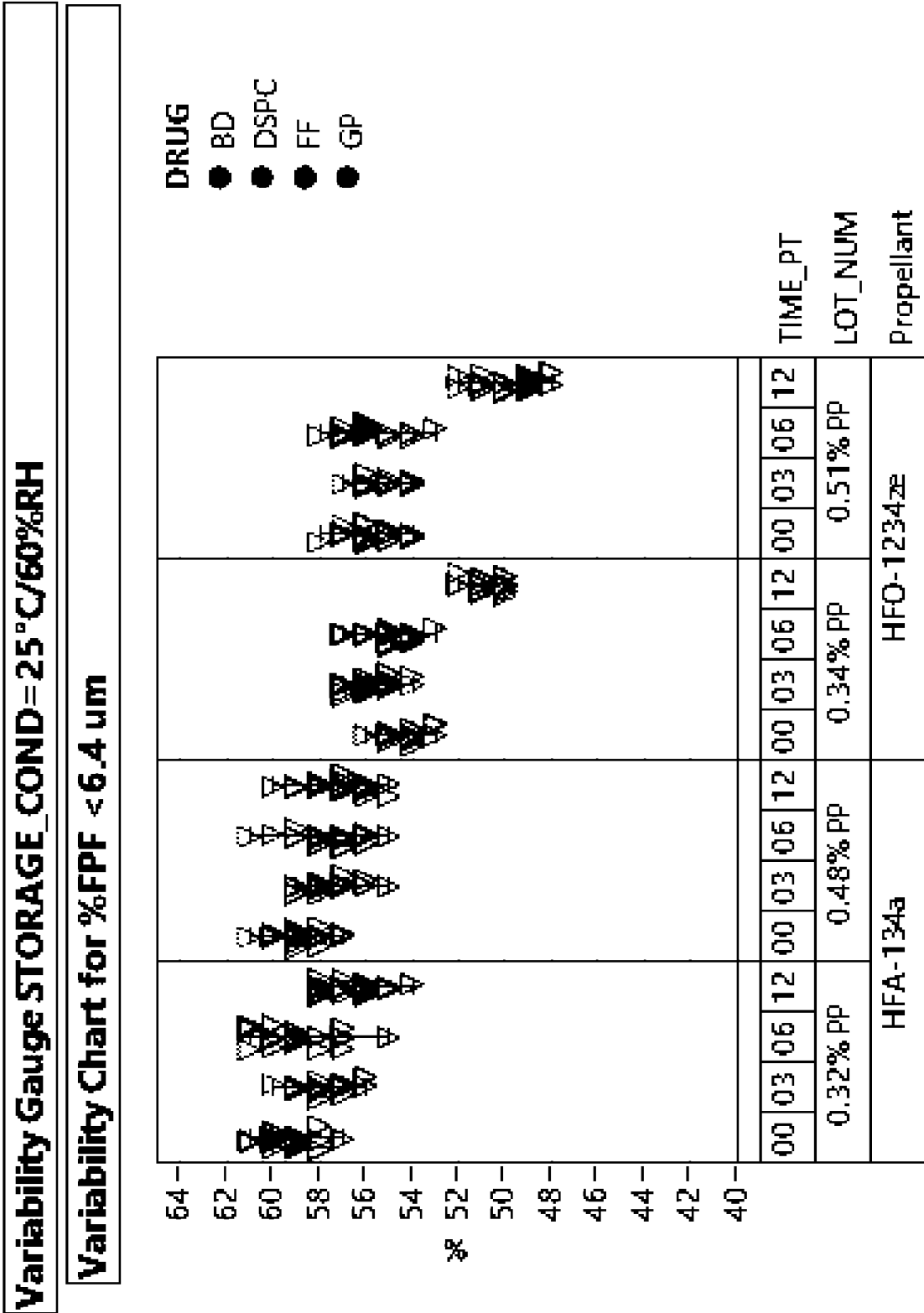


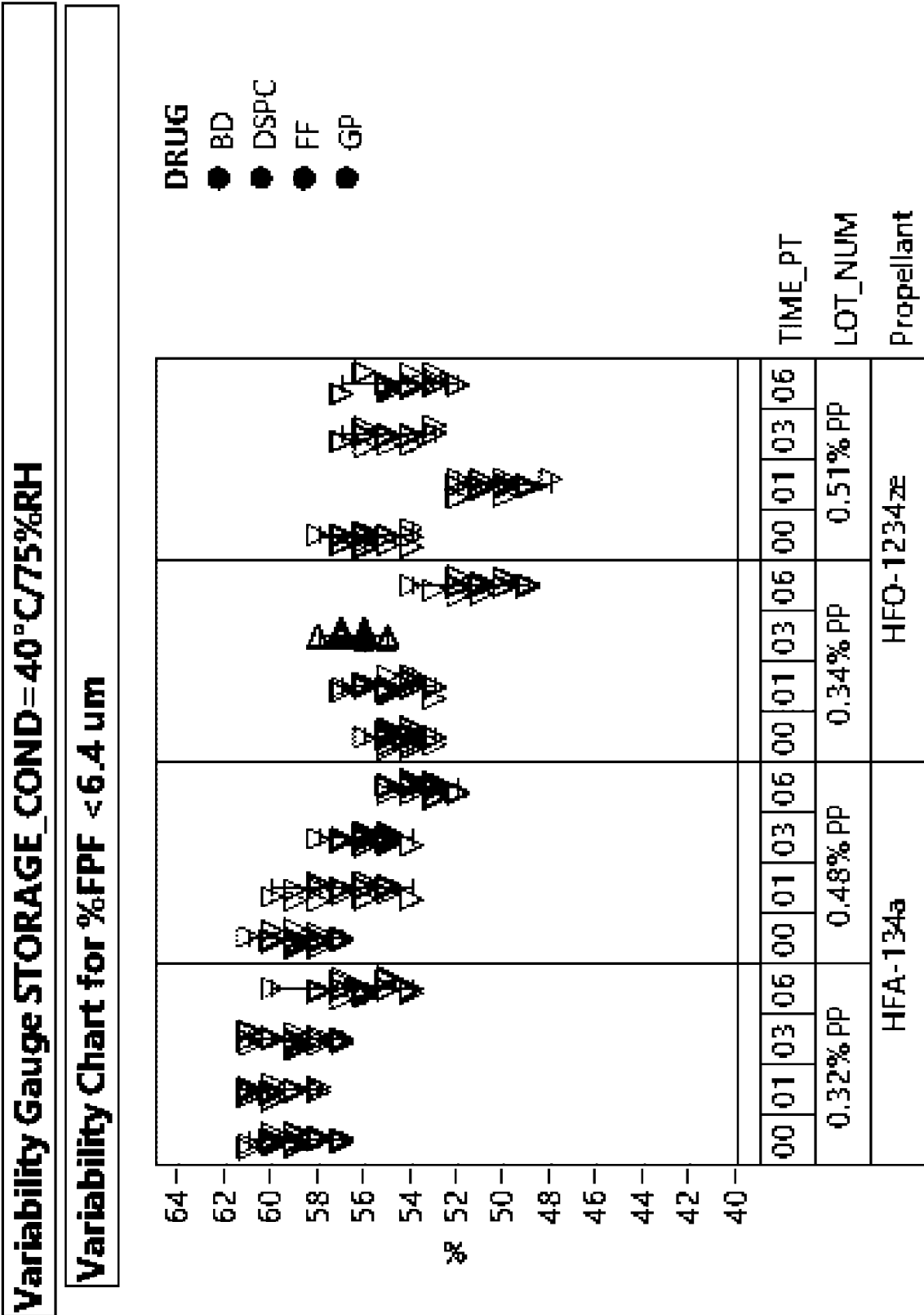
FIG. 9

10/63



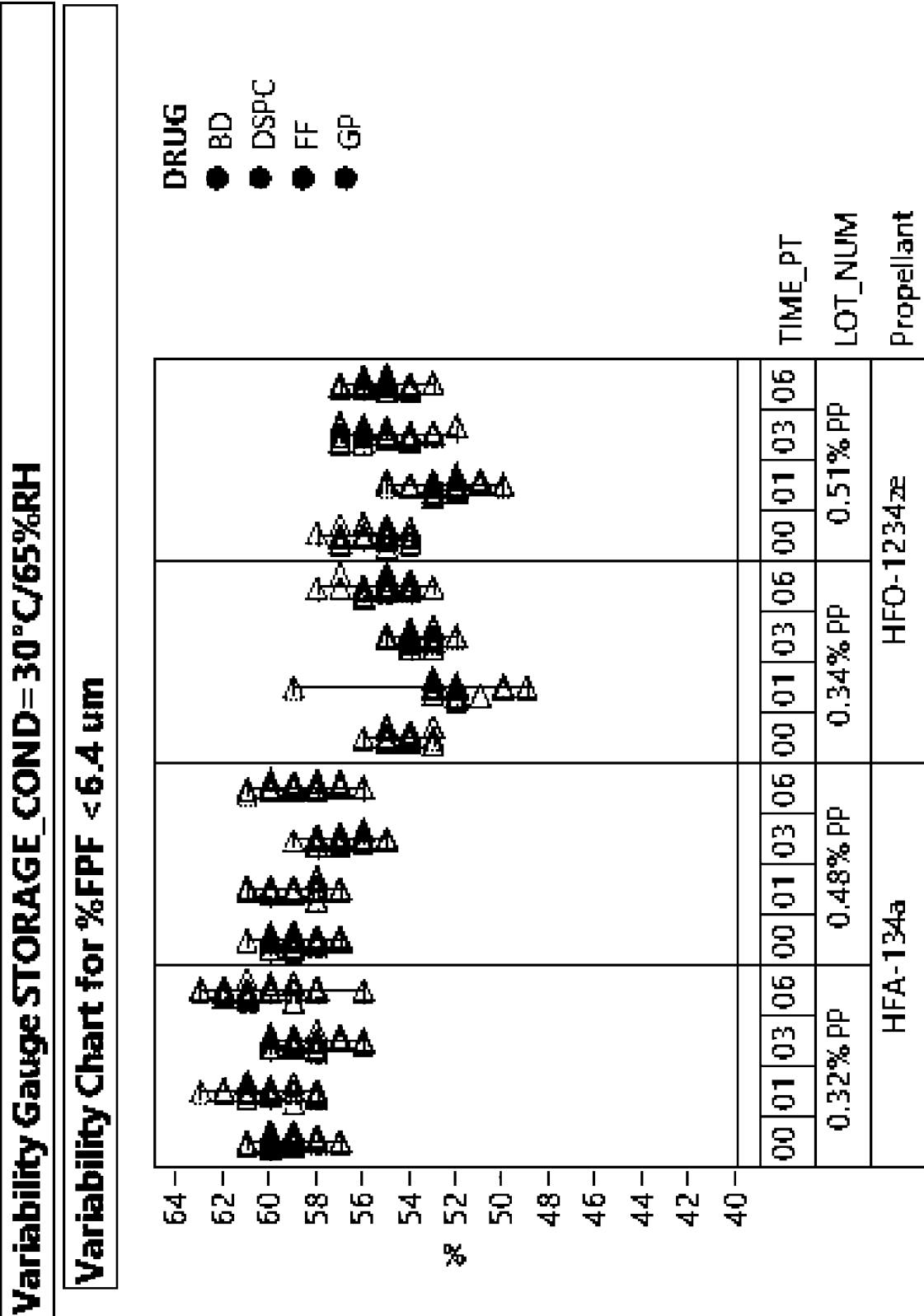
**FIG. 10A**

11/63

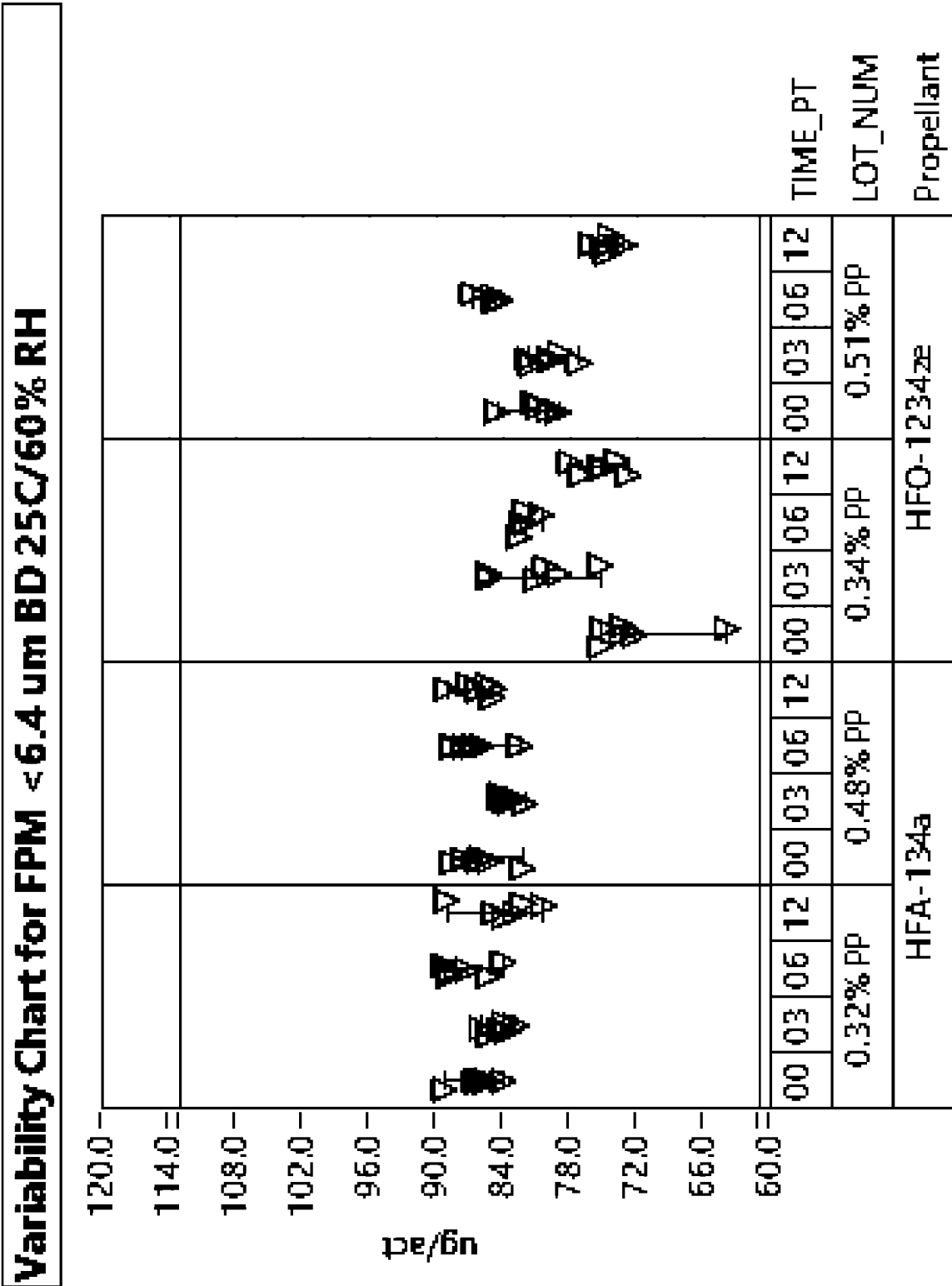


**FIG. 10B**

12/63

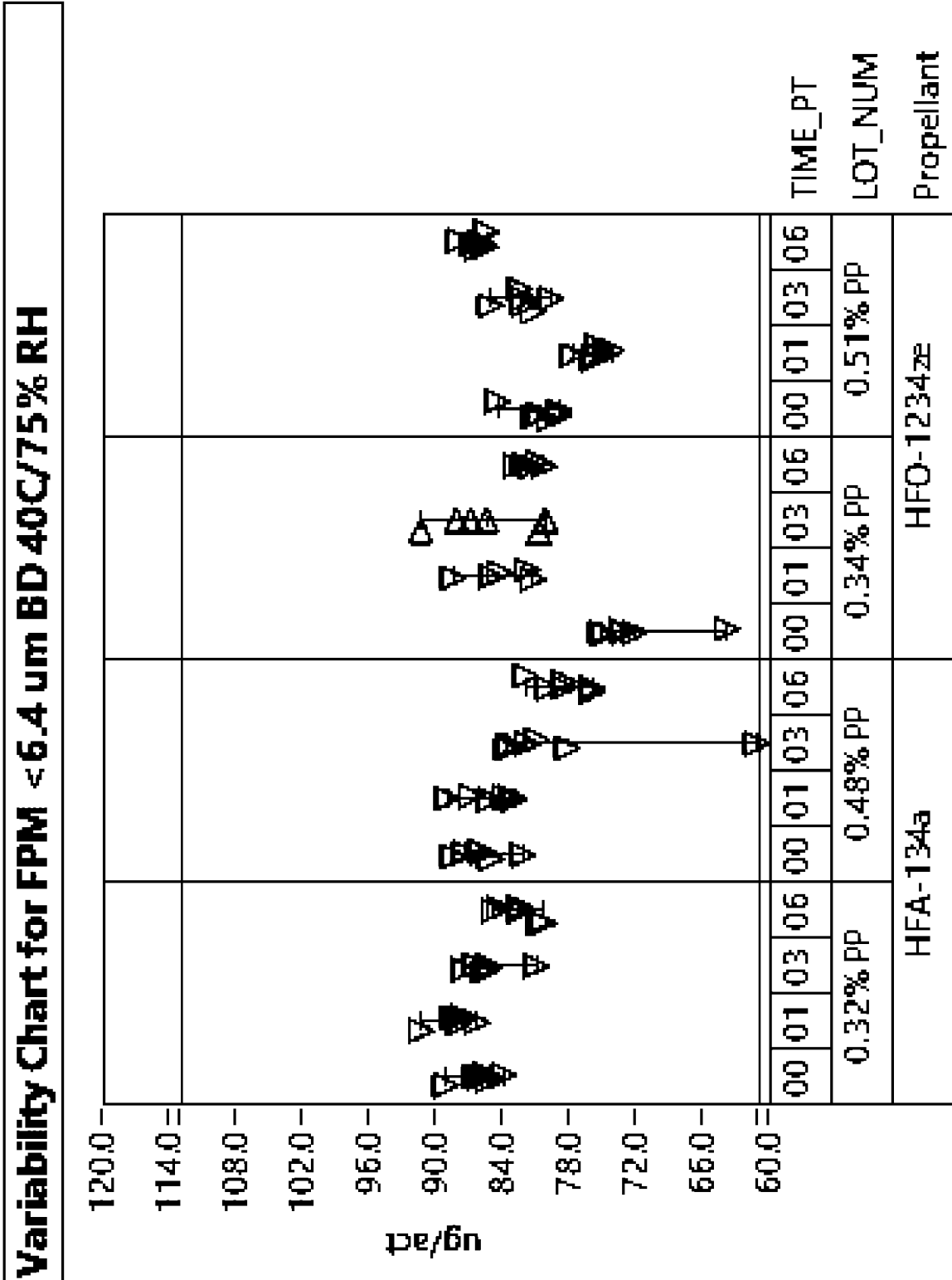


**FIG. 10C**



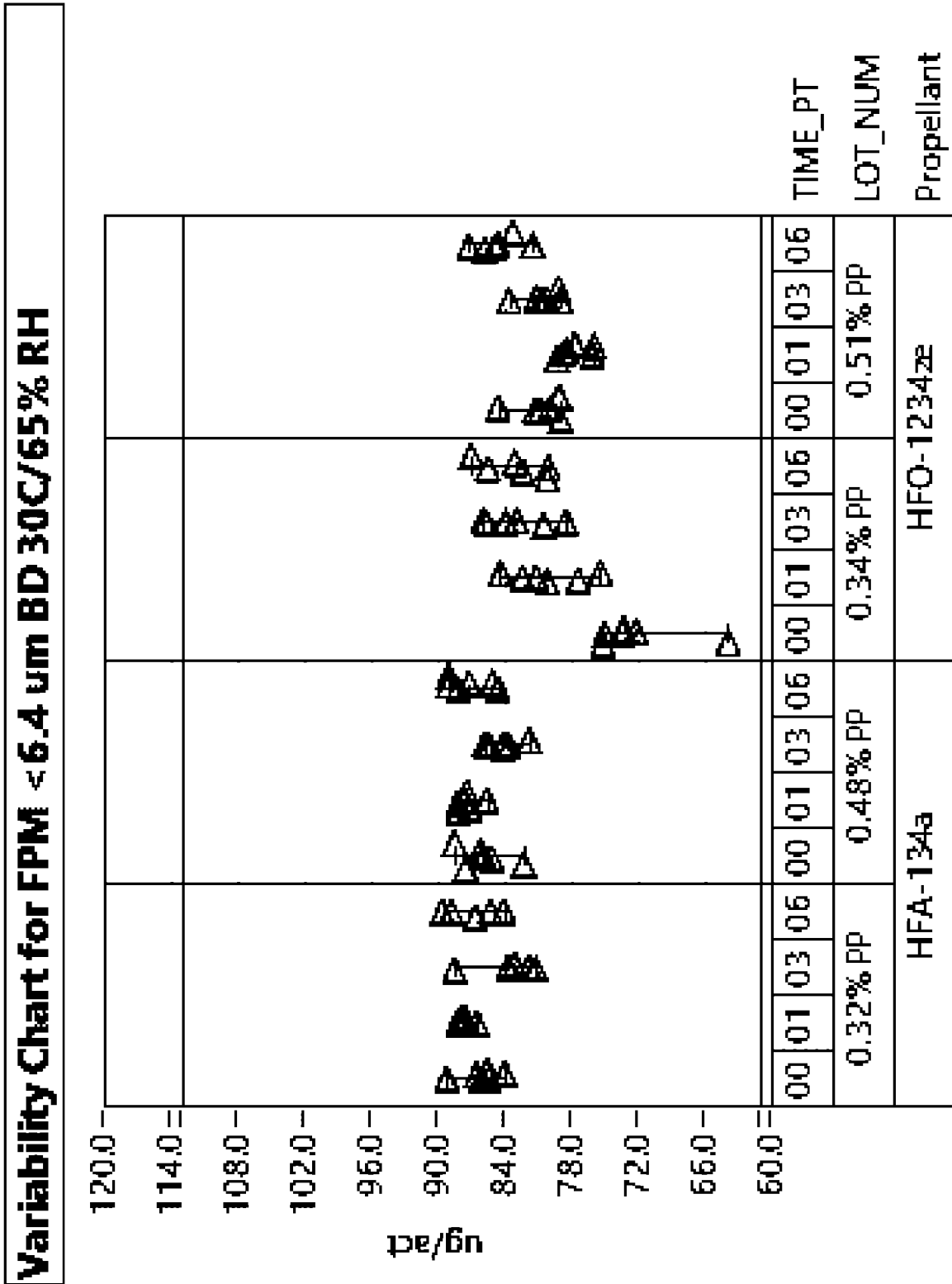
**FIG. 11A**

14/63



**FIG. 11B**

15/63



**FIG. 11C**

16/63

Variability Chart for BD 25C/60%RH

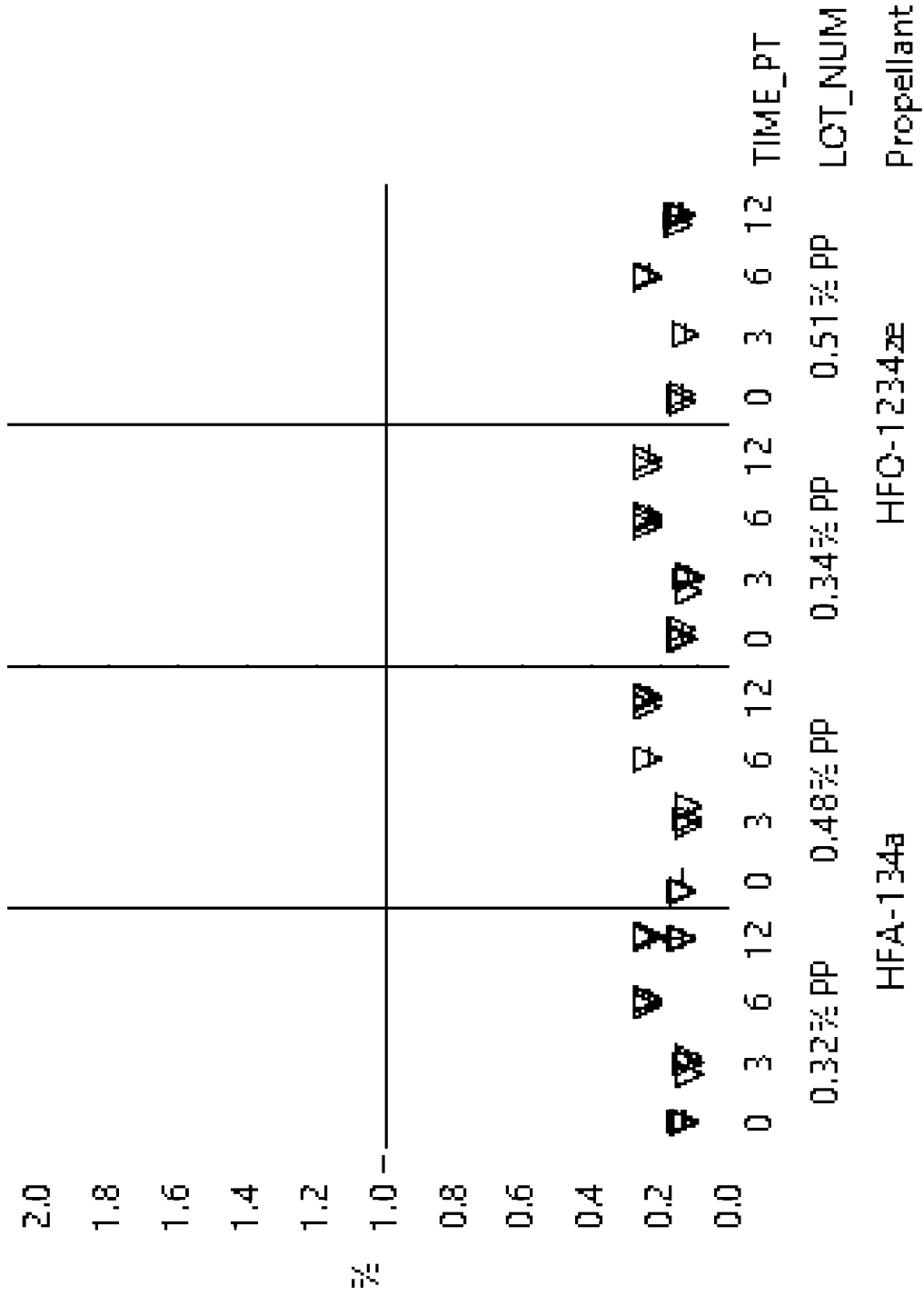
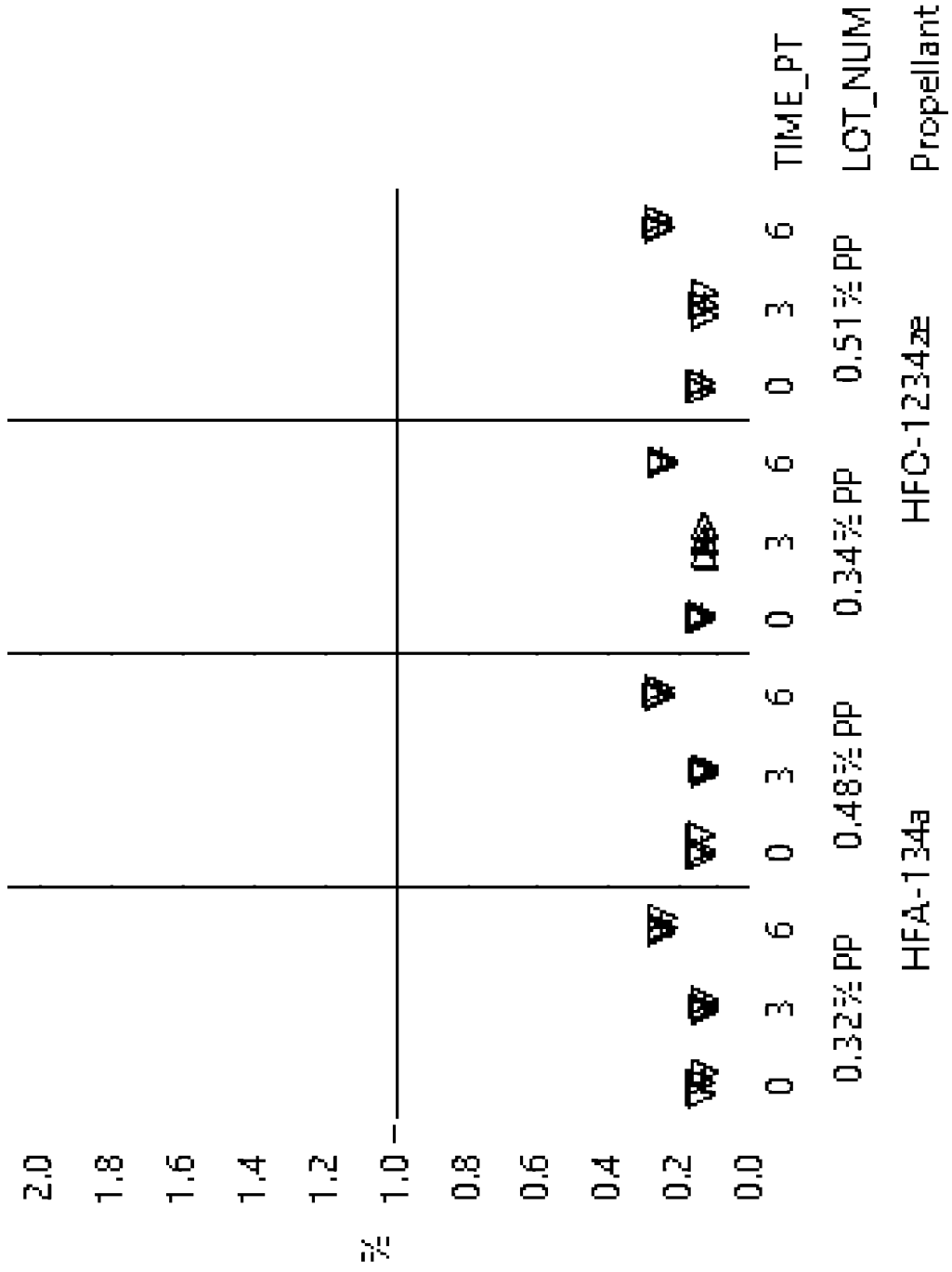


FIG. 12A

17/63

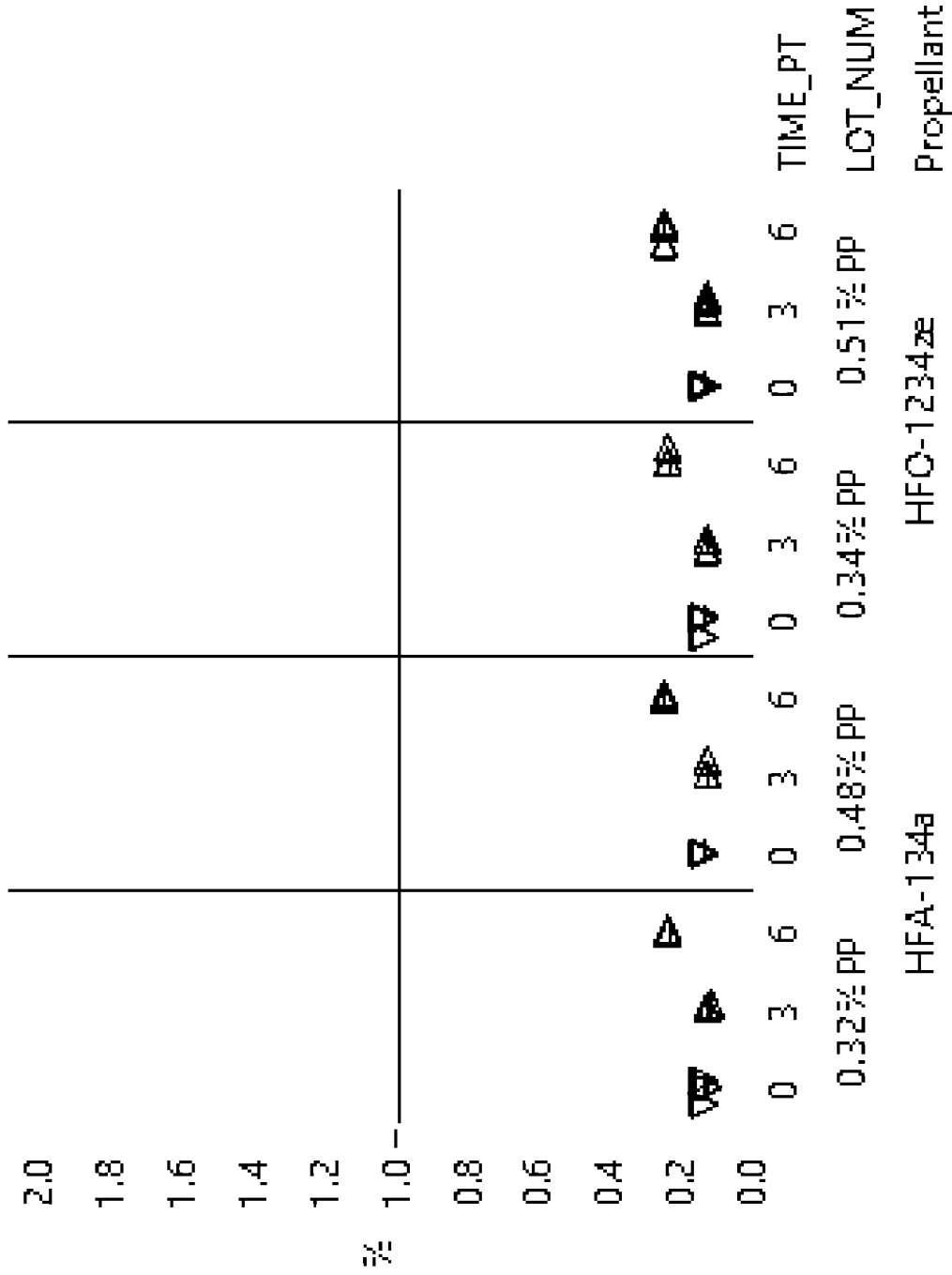
**Variability Chart for BD 40C/75% RH**



**FIG. 12B**

18/63

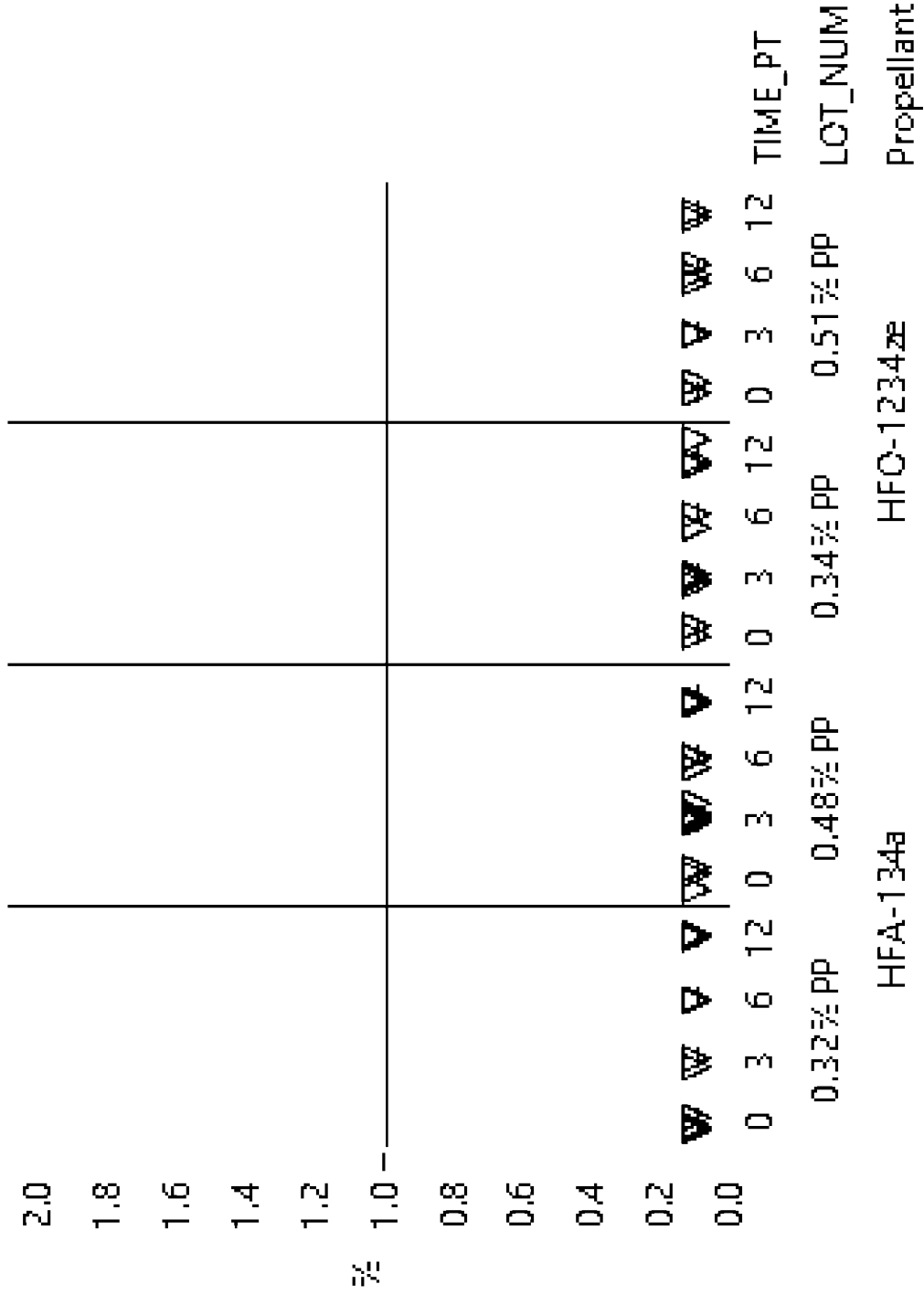
**Variability Chart for BD 30C/65% RH**



**FIG. 12C**

19/63

**Variability Chart for GP 25C/60% RH**



**FIG. 13A**



21/63

Variability Chart for GP 30C/65% RH

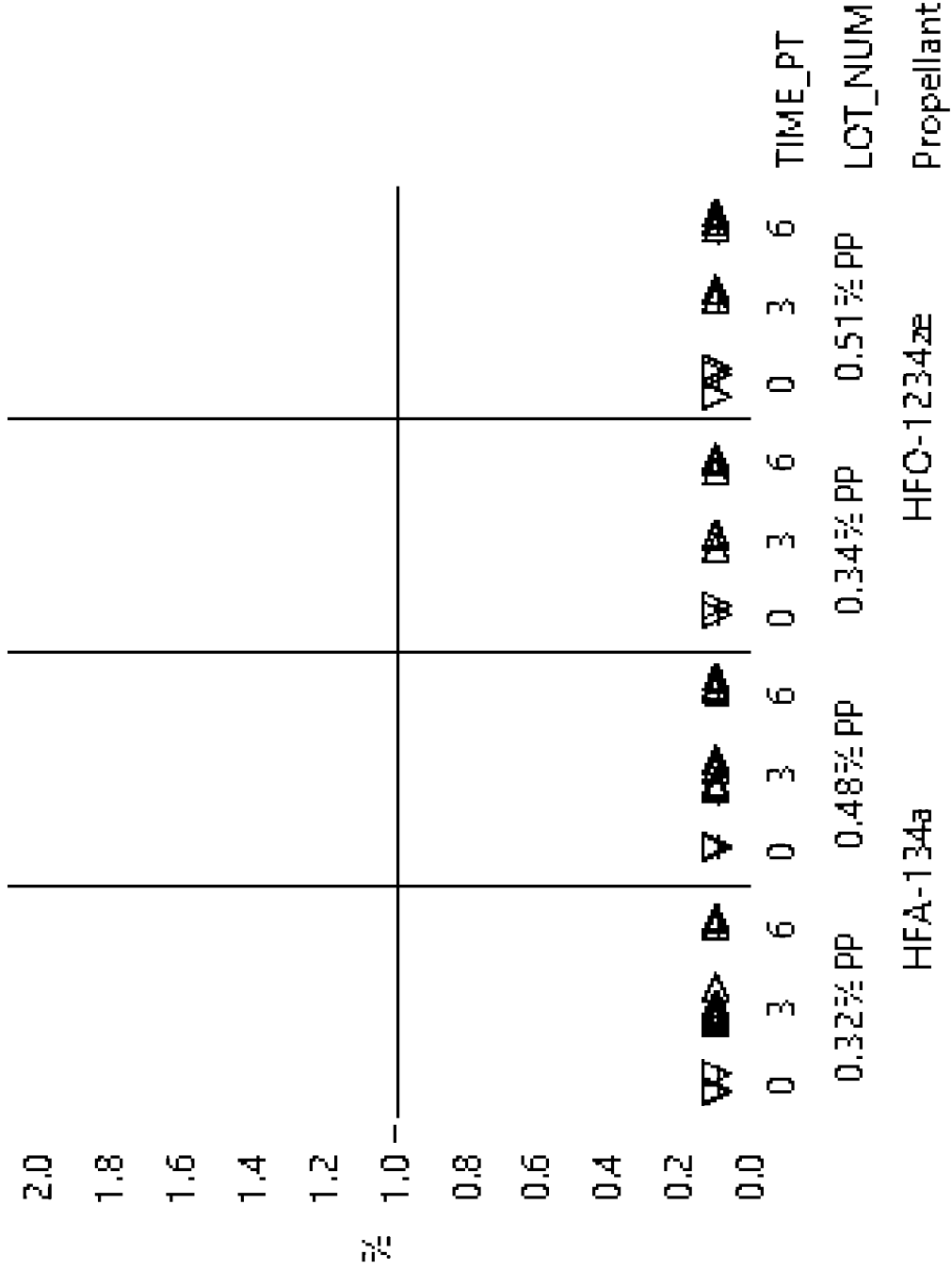


FIG. 13C

Variability Gauge DRUG=BD, STORCOND=25°C/60%RH

Variability Chart for Result

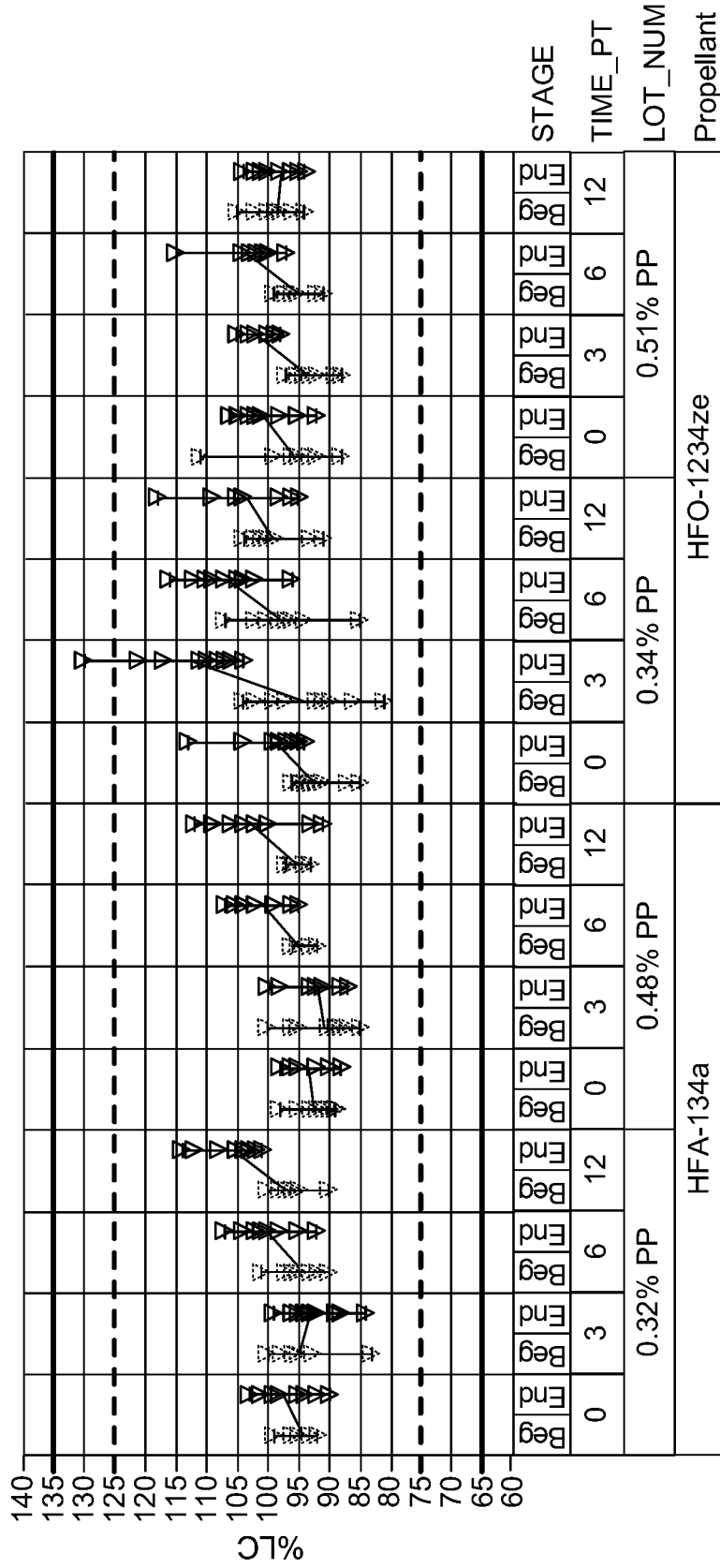


FIG. 14A

Variability Gauge DRUG=BD, STORCOND=40°C/75%RH

Variability Chart for Result

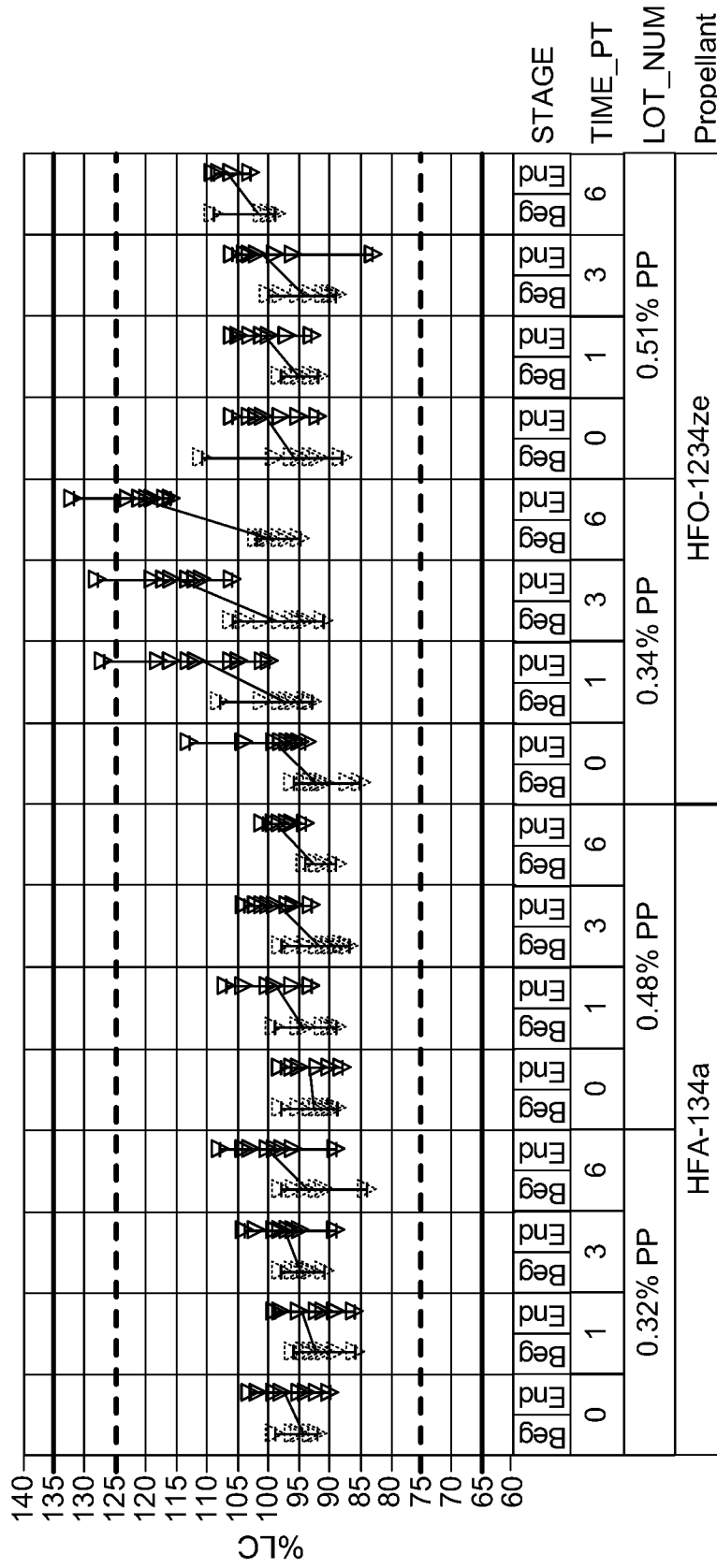


FIG. 14B

24/63

Variability Gauge DRUG=BD, STORCOND=30°C/65%RH

Variability Chart for Result

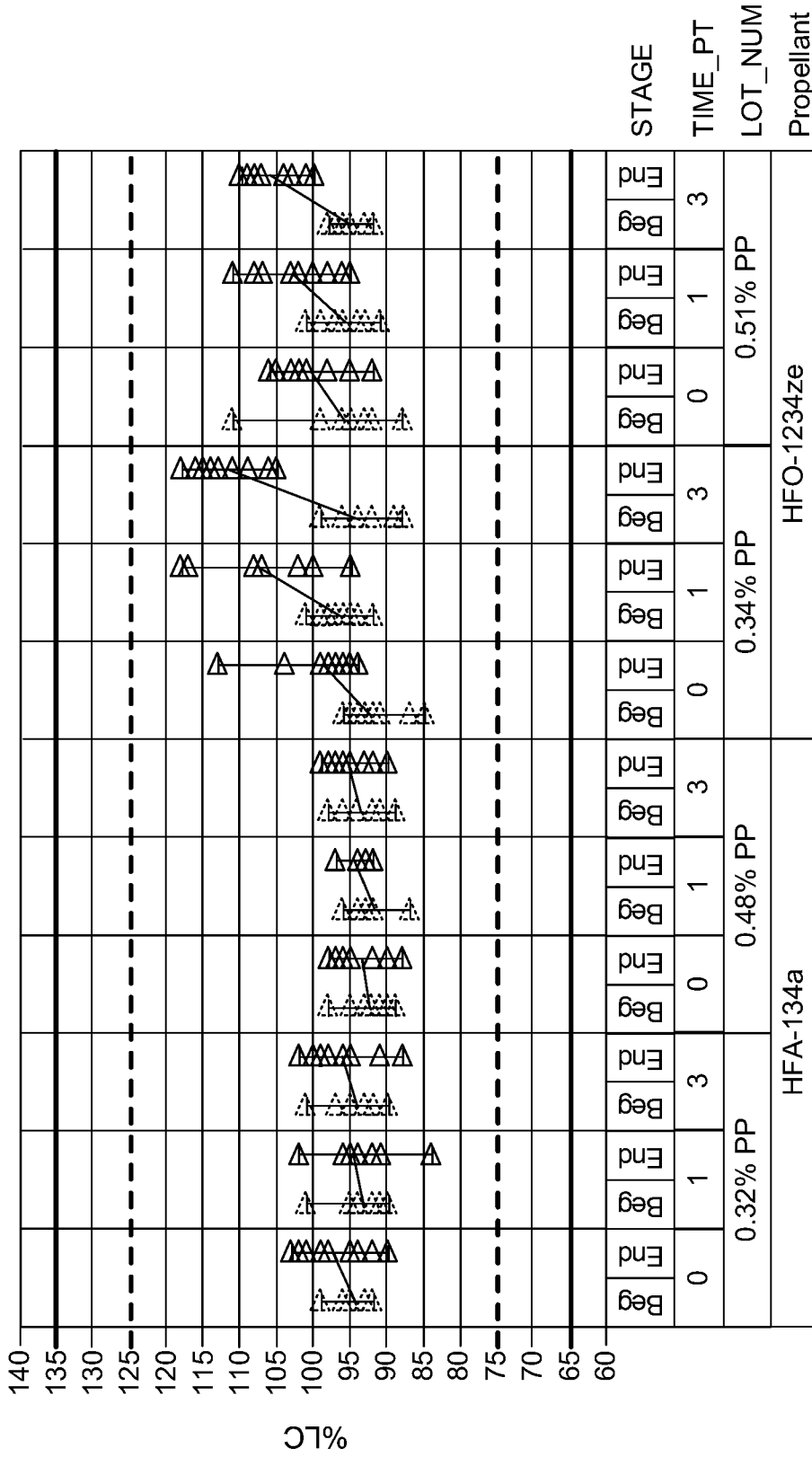


FIG. 14C

25/63

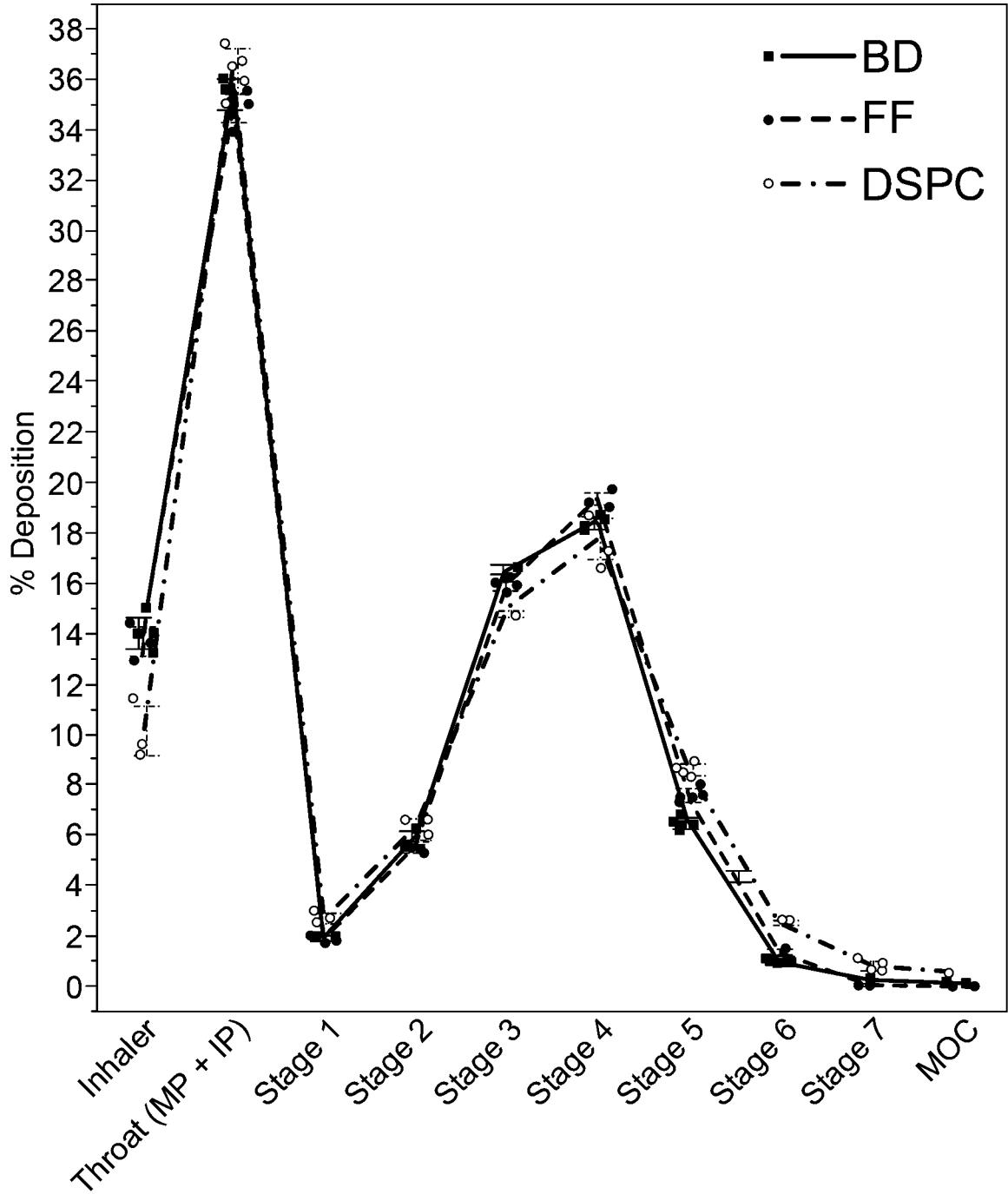


FIG. 15

26/63

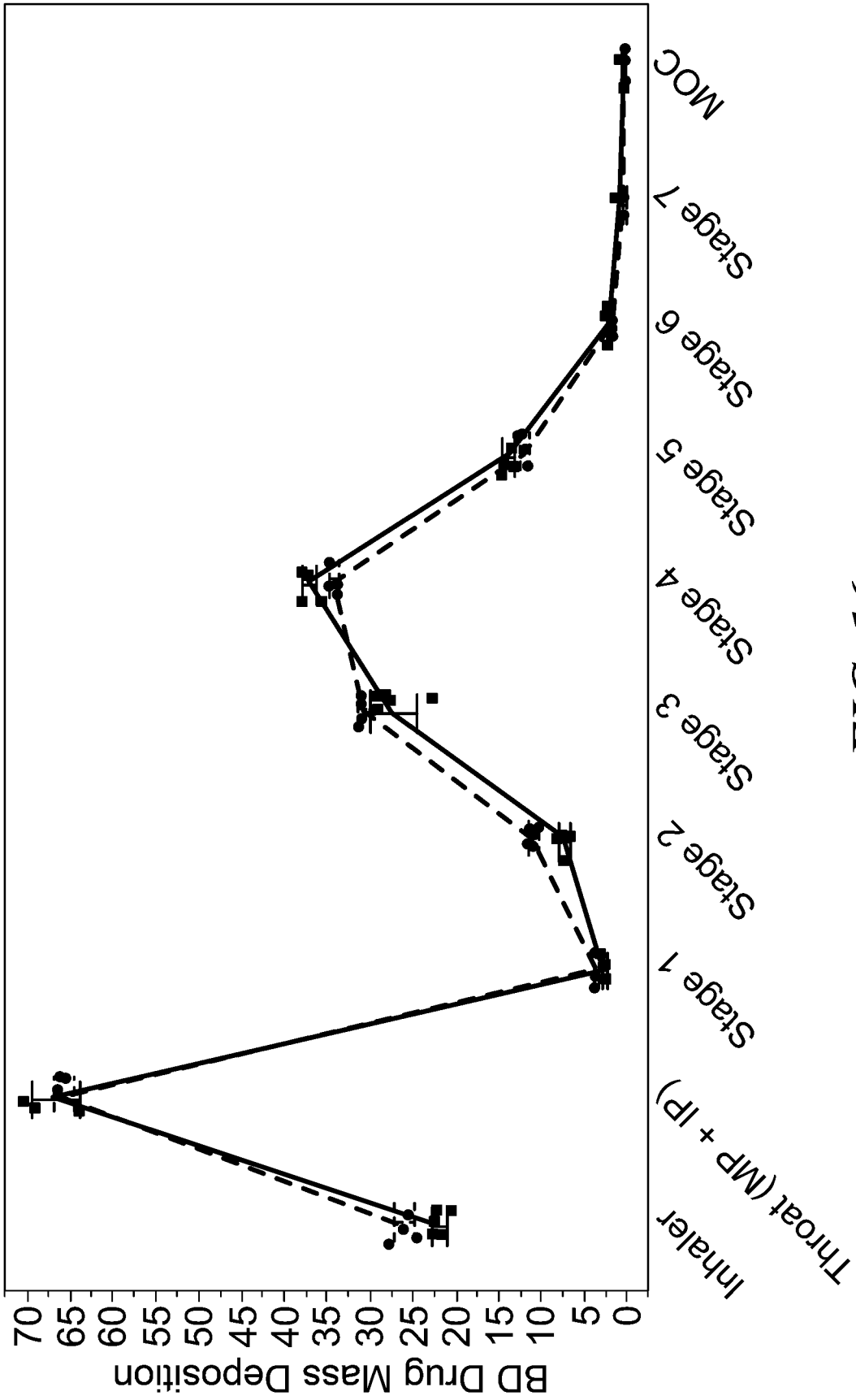


FIG. 16

27/63

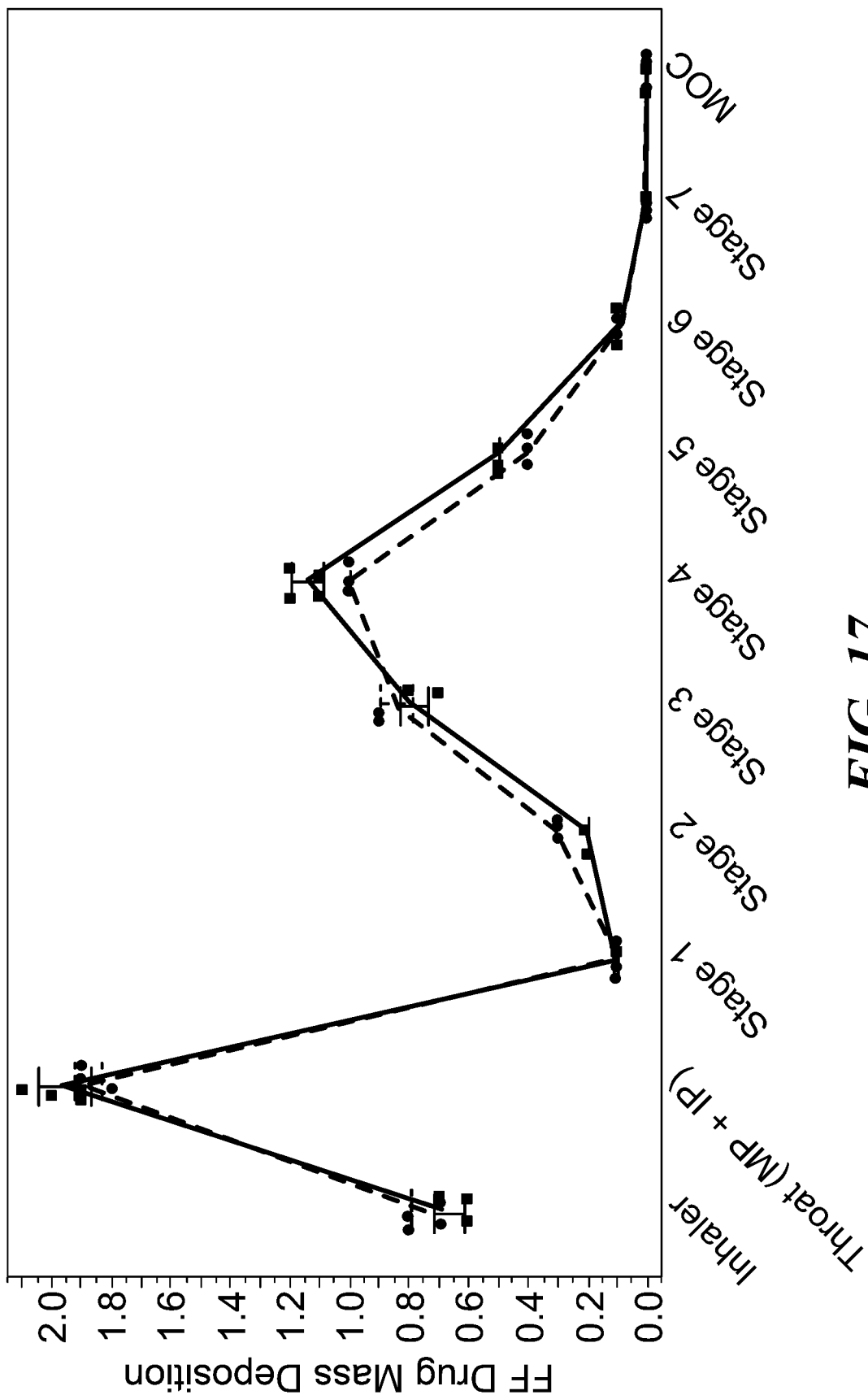


FIG. 17

28/63

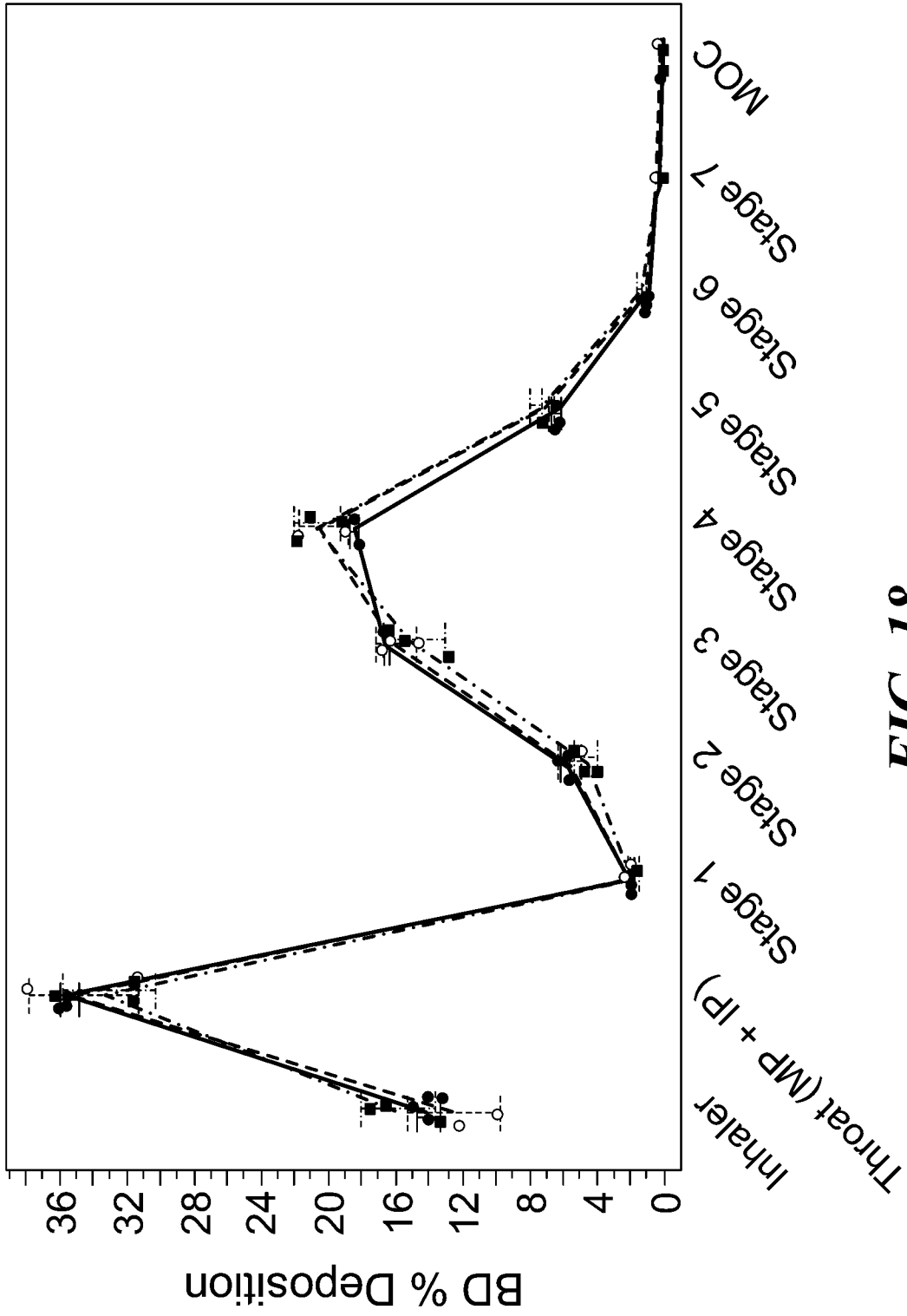


FIG. 18

29/63

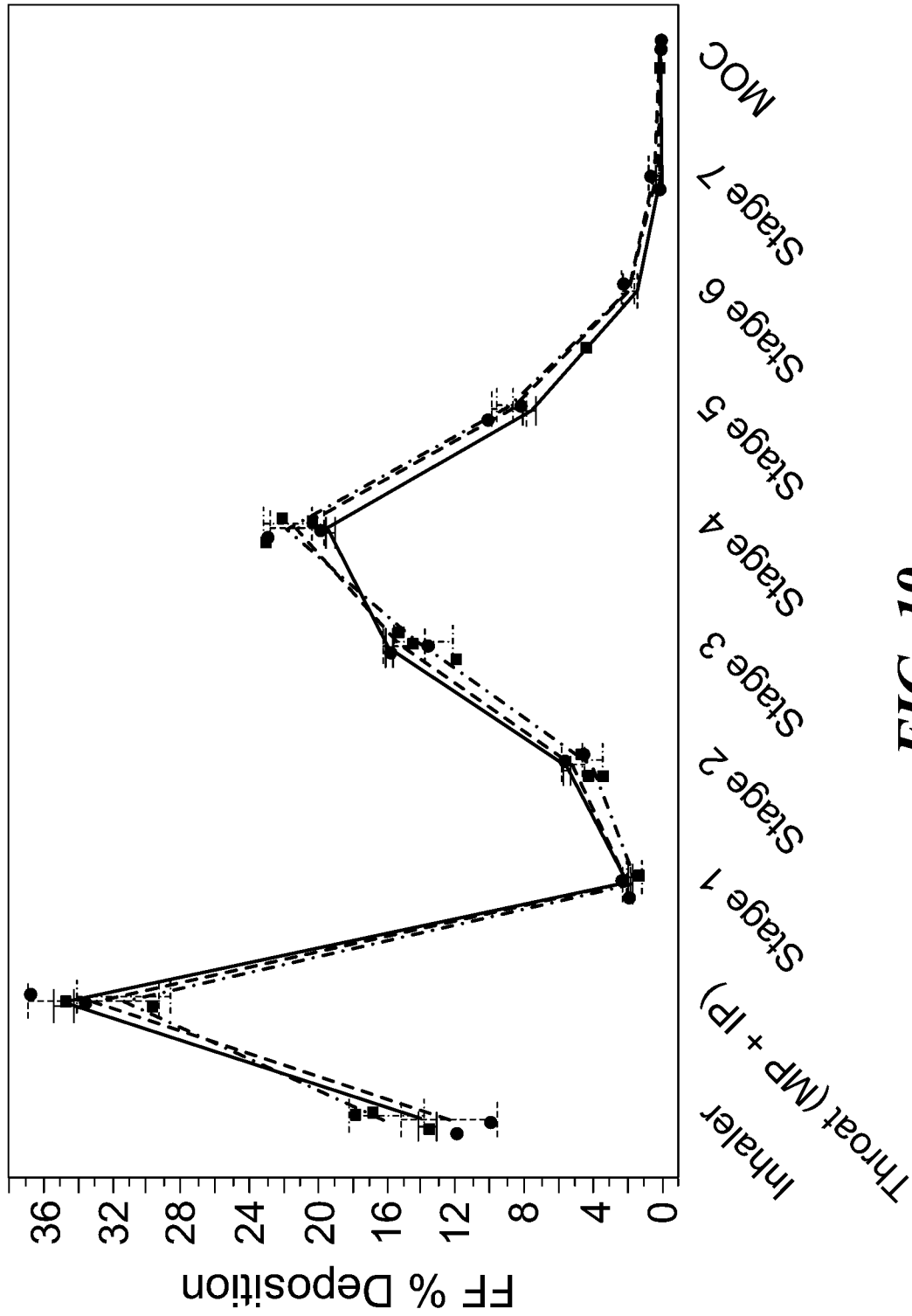


FIG. 19

30/63

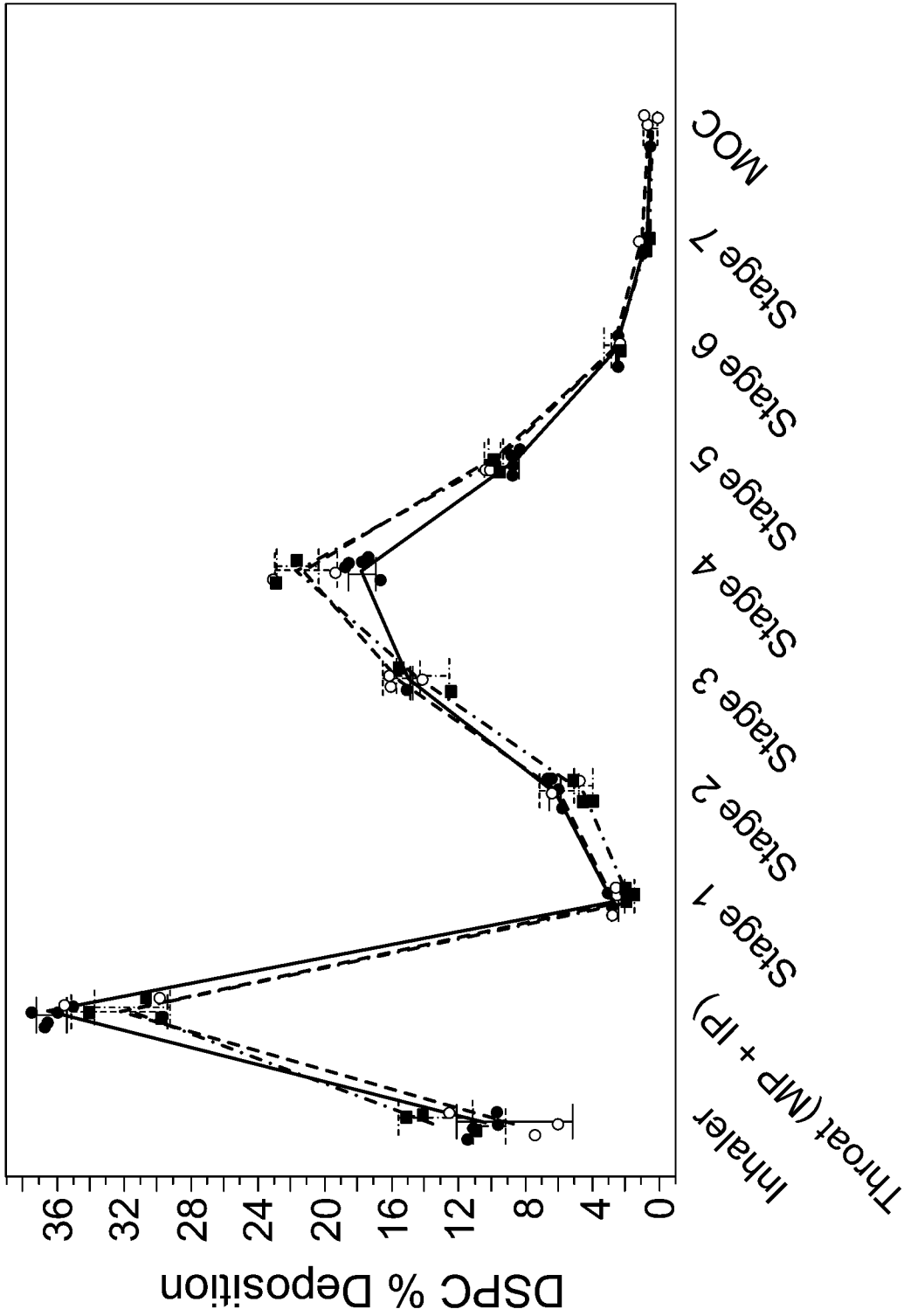


FIG. 20

31/63

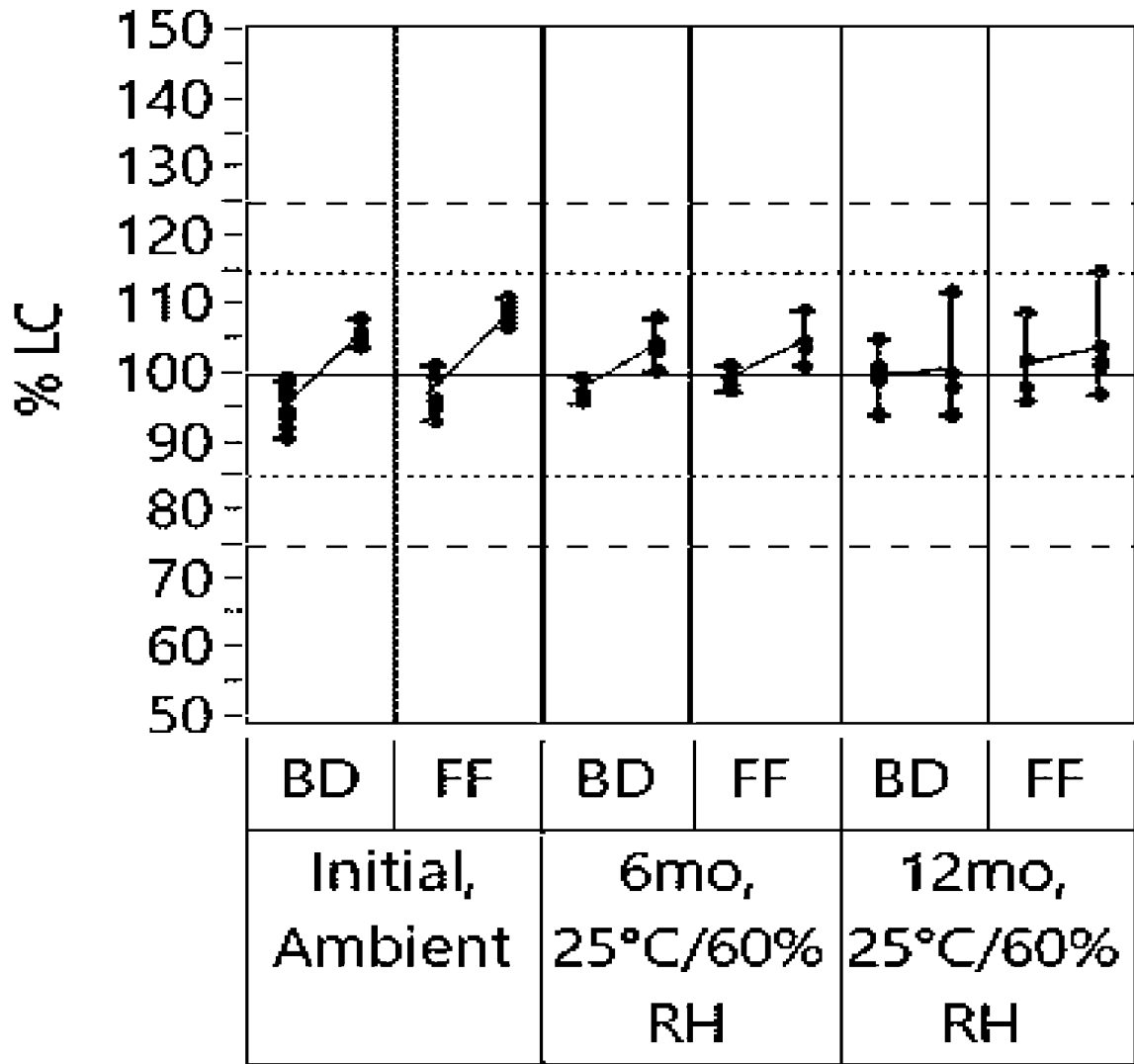


FIG. 21

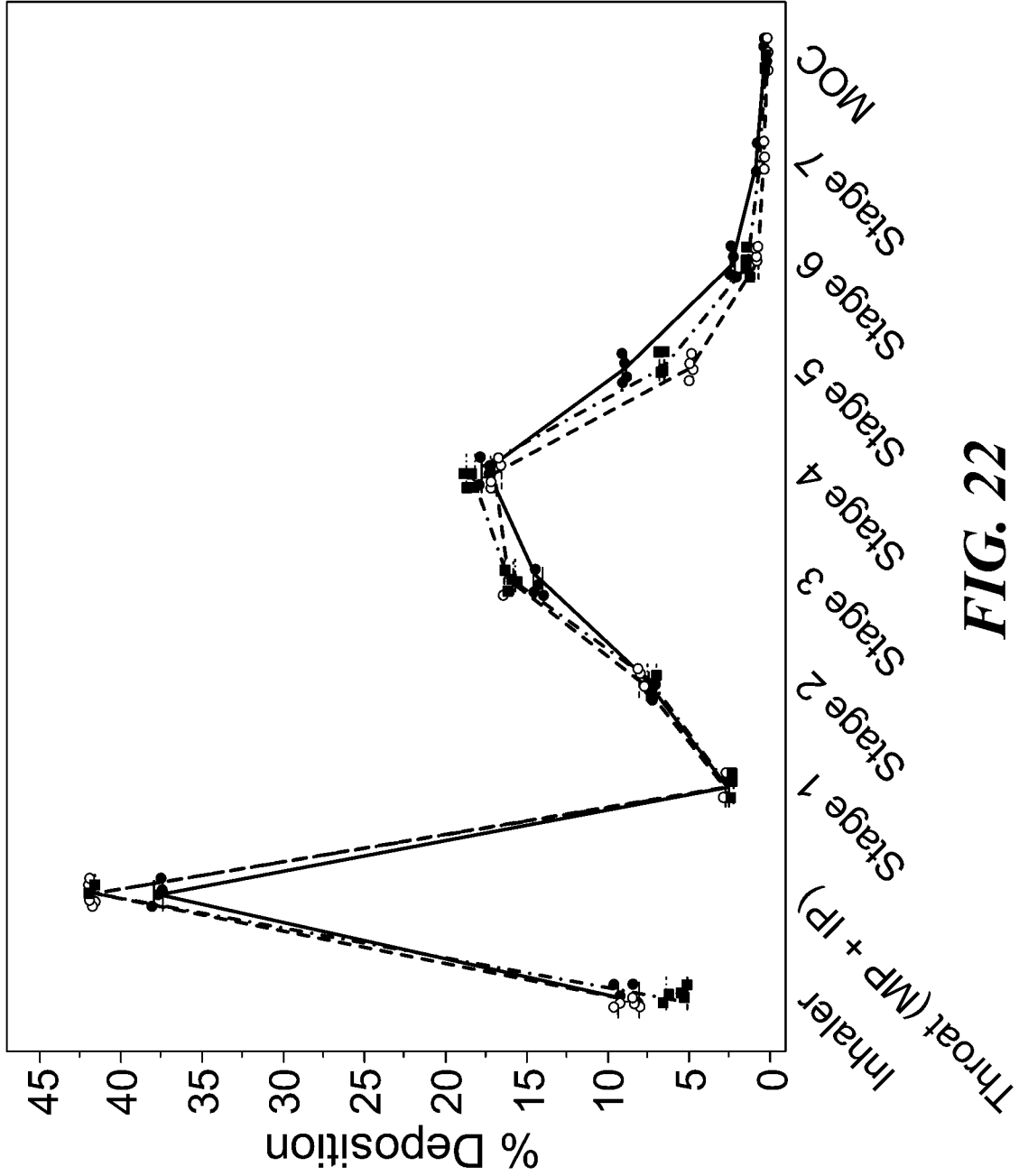


FIG. 22

33/63

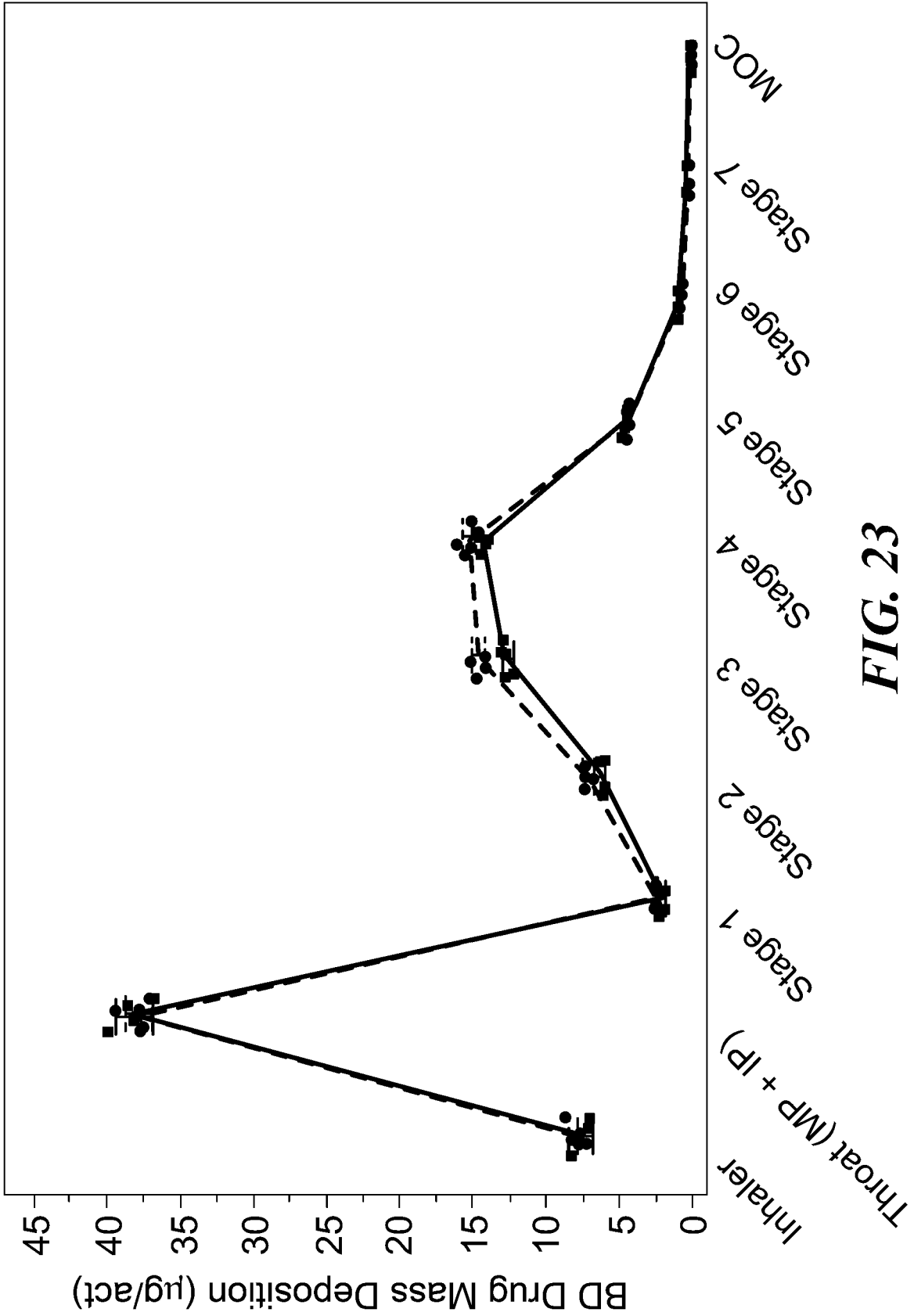


FIG. 23

34/63

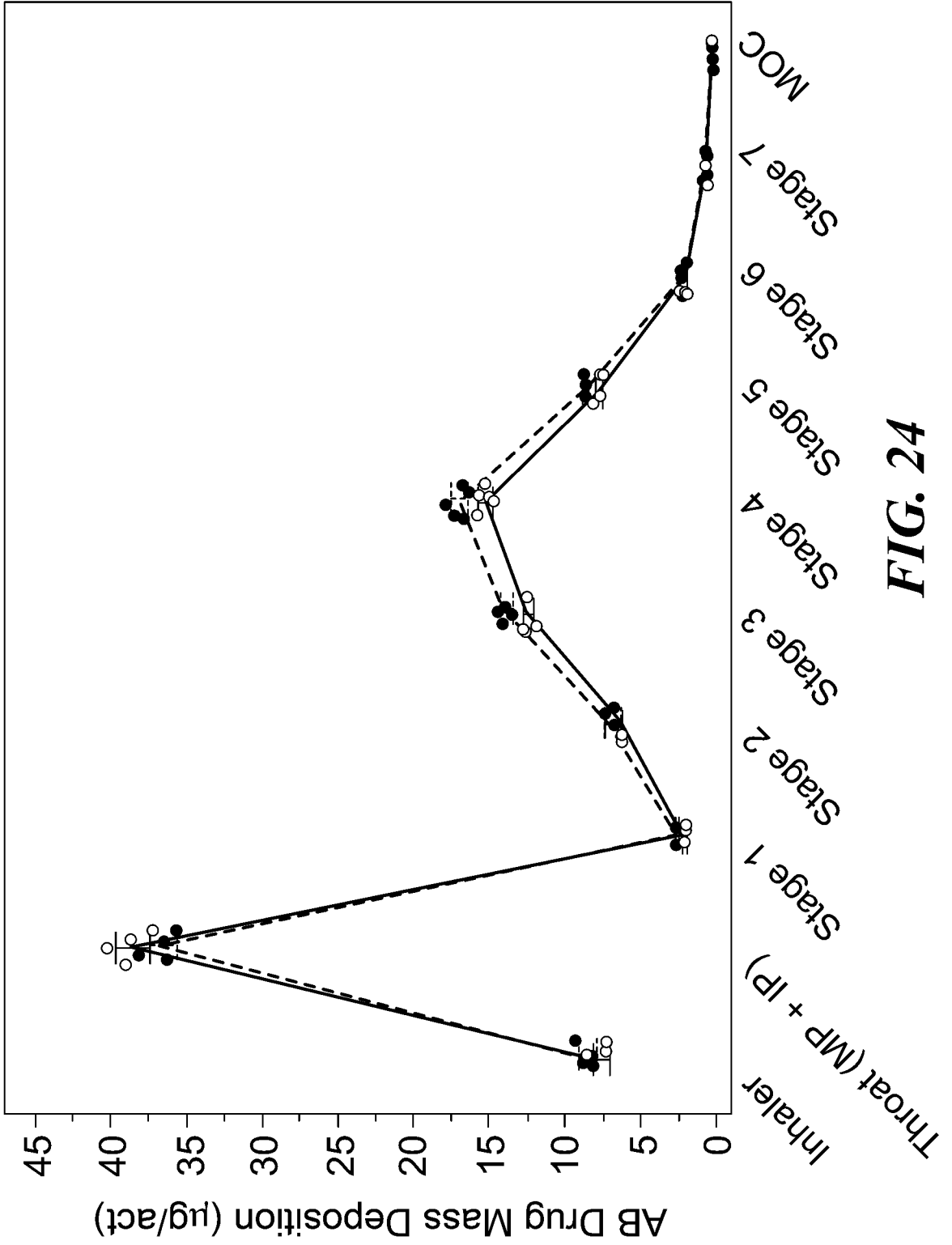


FIG. 24

35/63

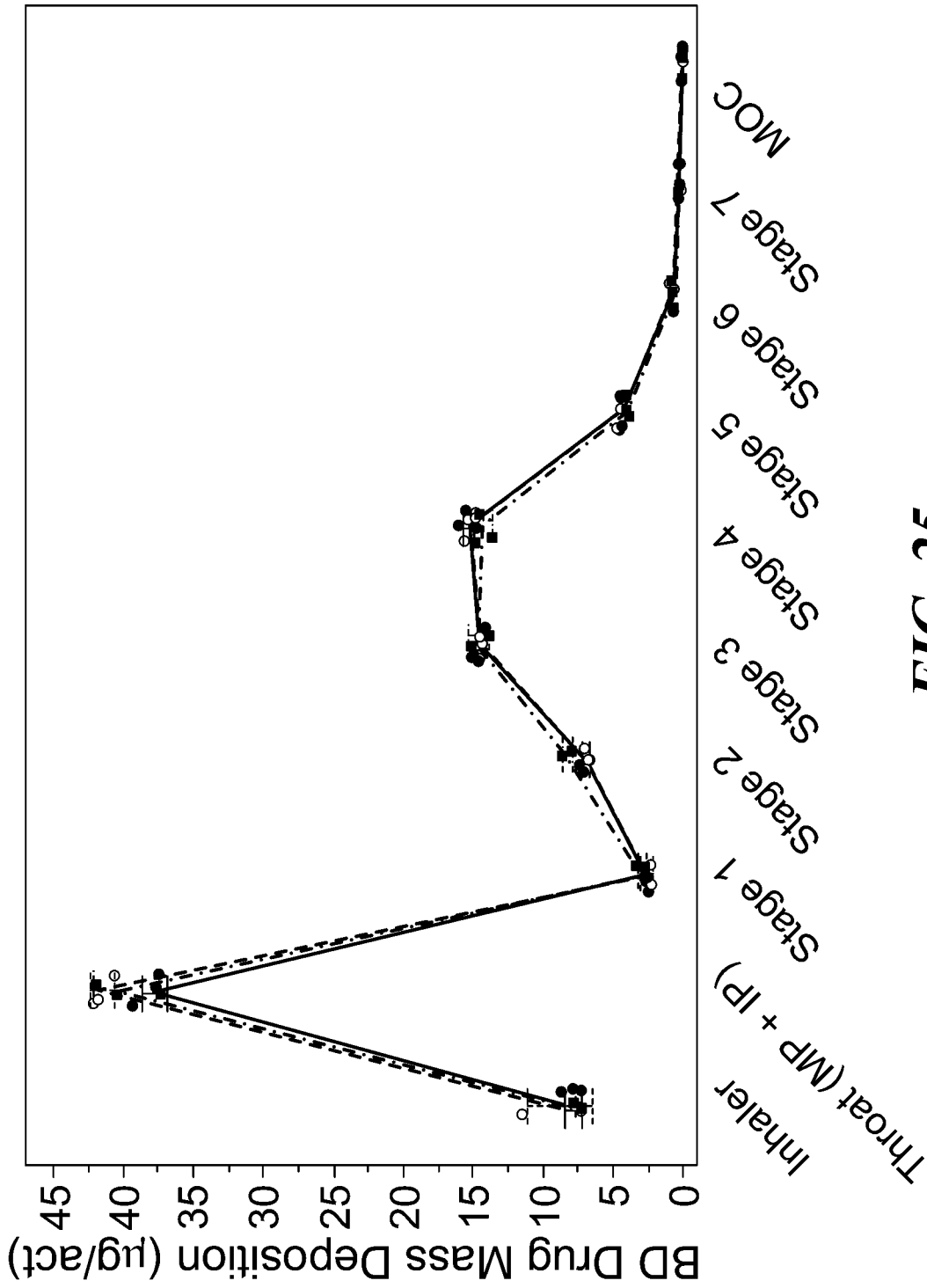


FIG. 25

36/63

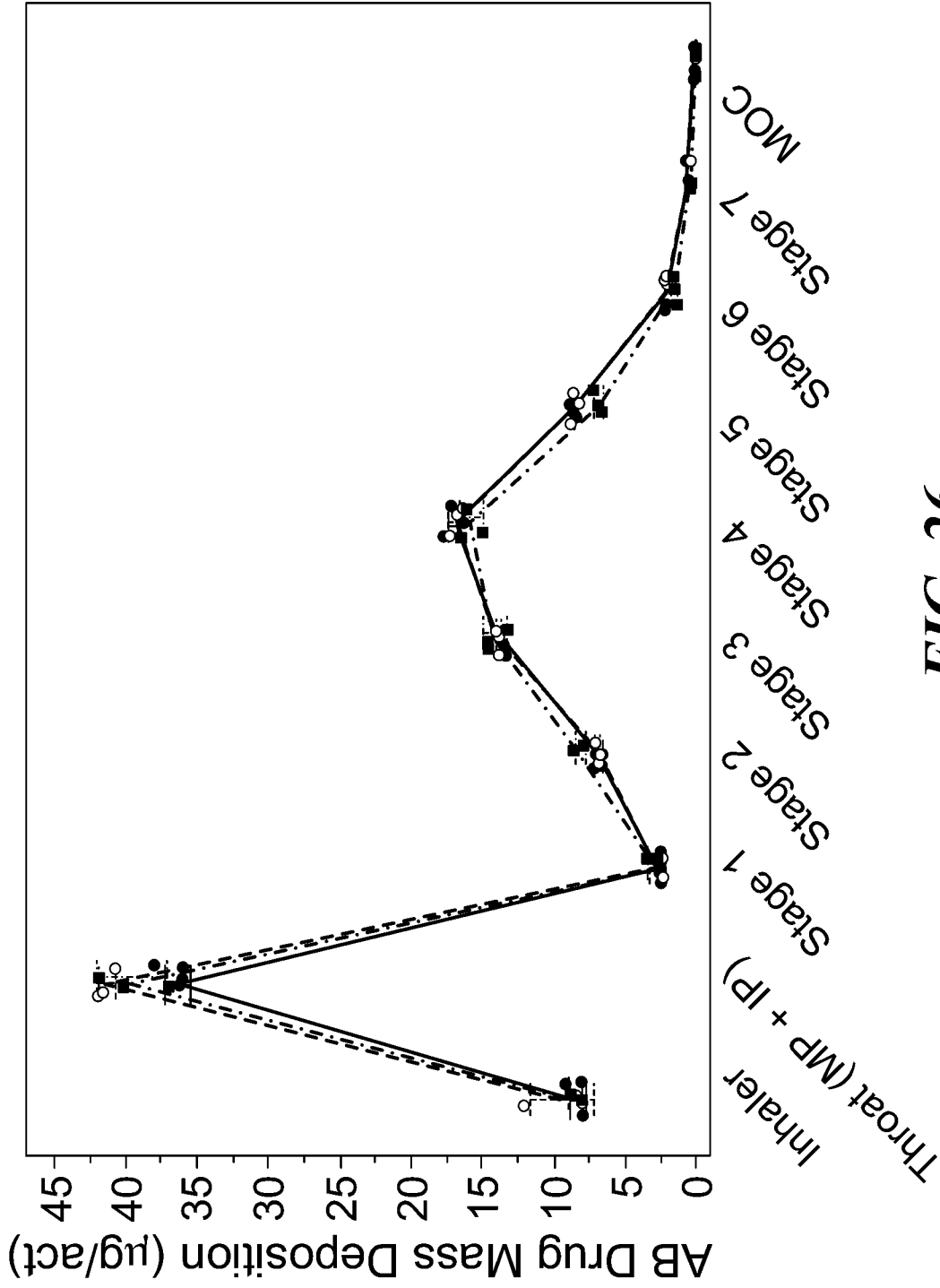
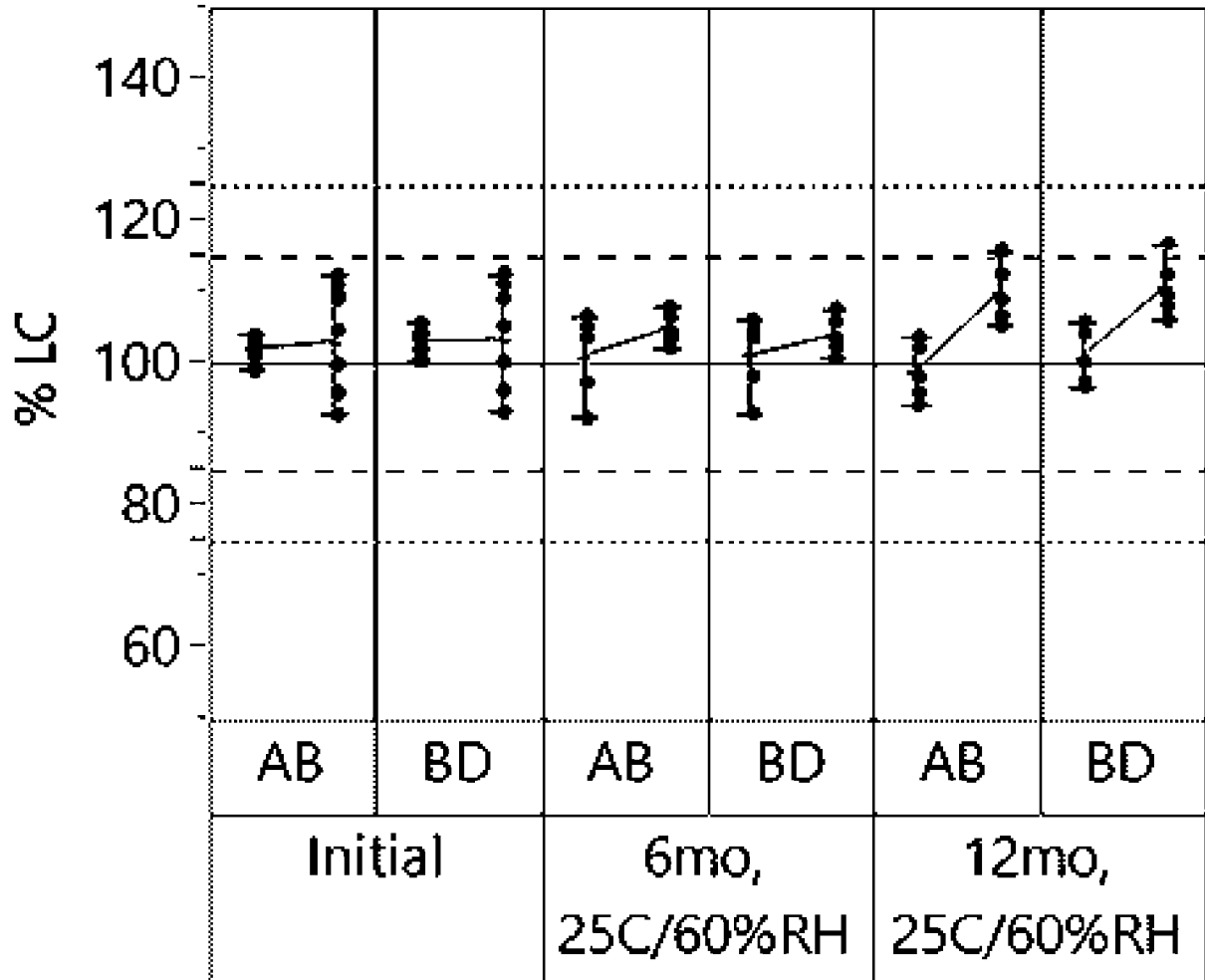


FIG. 26

**37/63**



**FIG. 27**

38/63

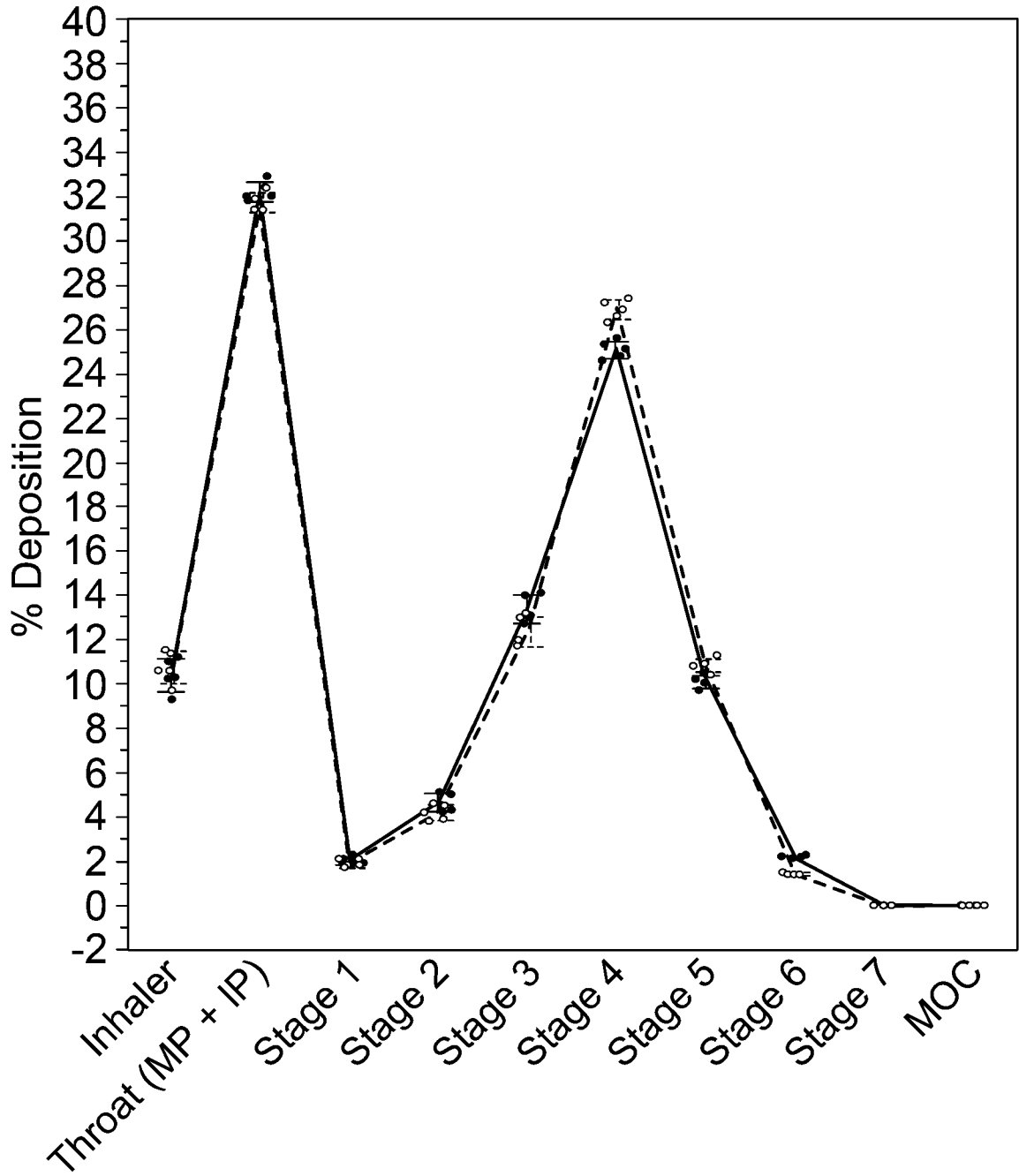
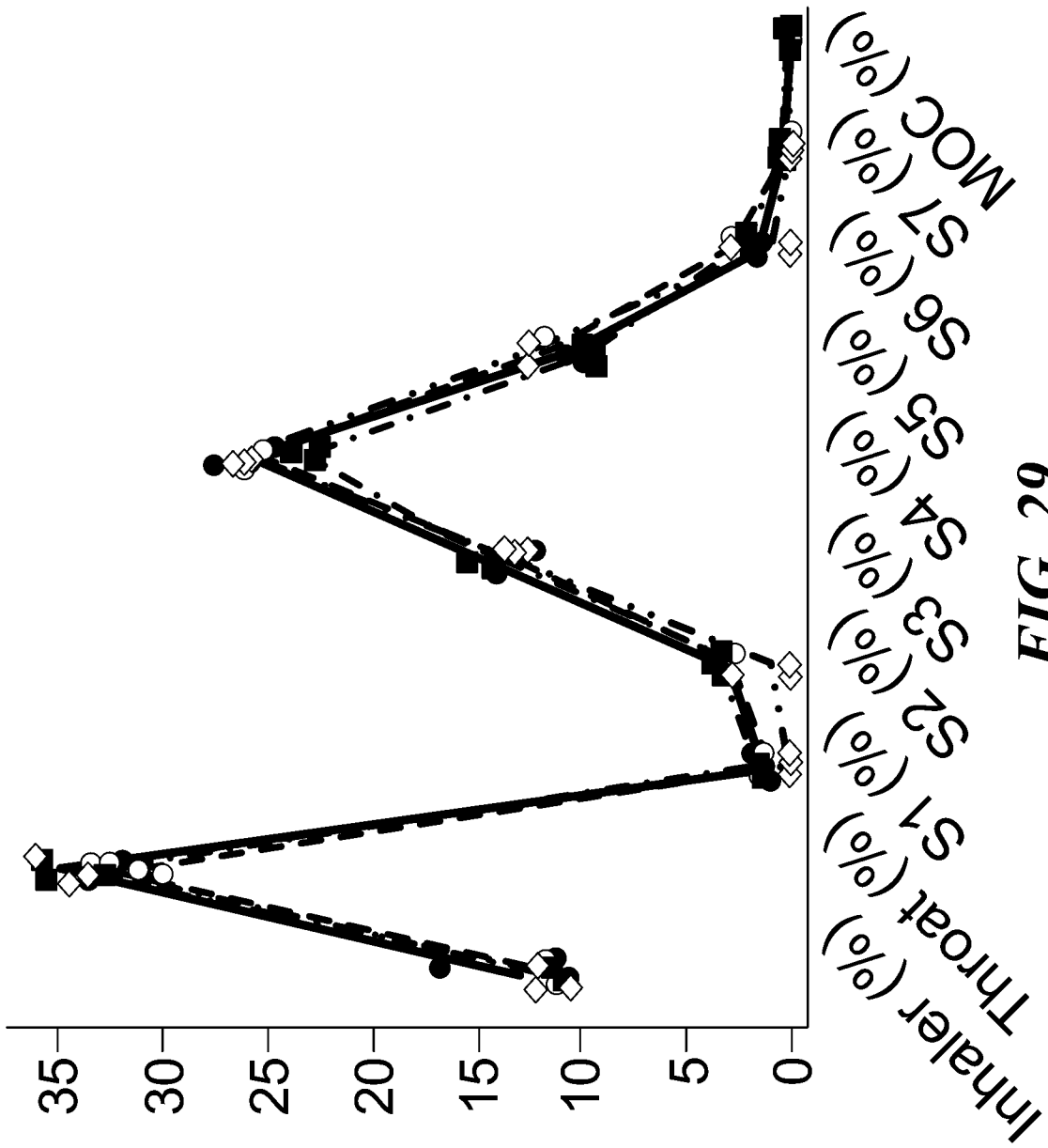


FIG. 28

39/63



40/63

API/Test Info  
● Budesonide  
○ Formoterol  
■ Glycopyrrrolate  
◇ Roflumilast

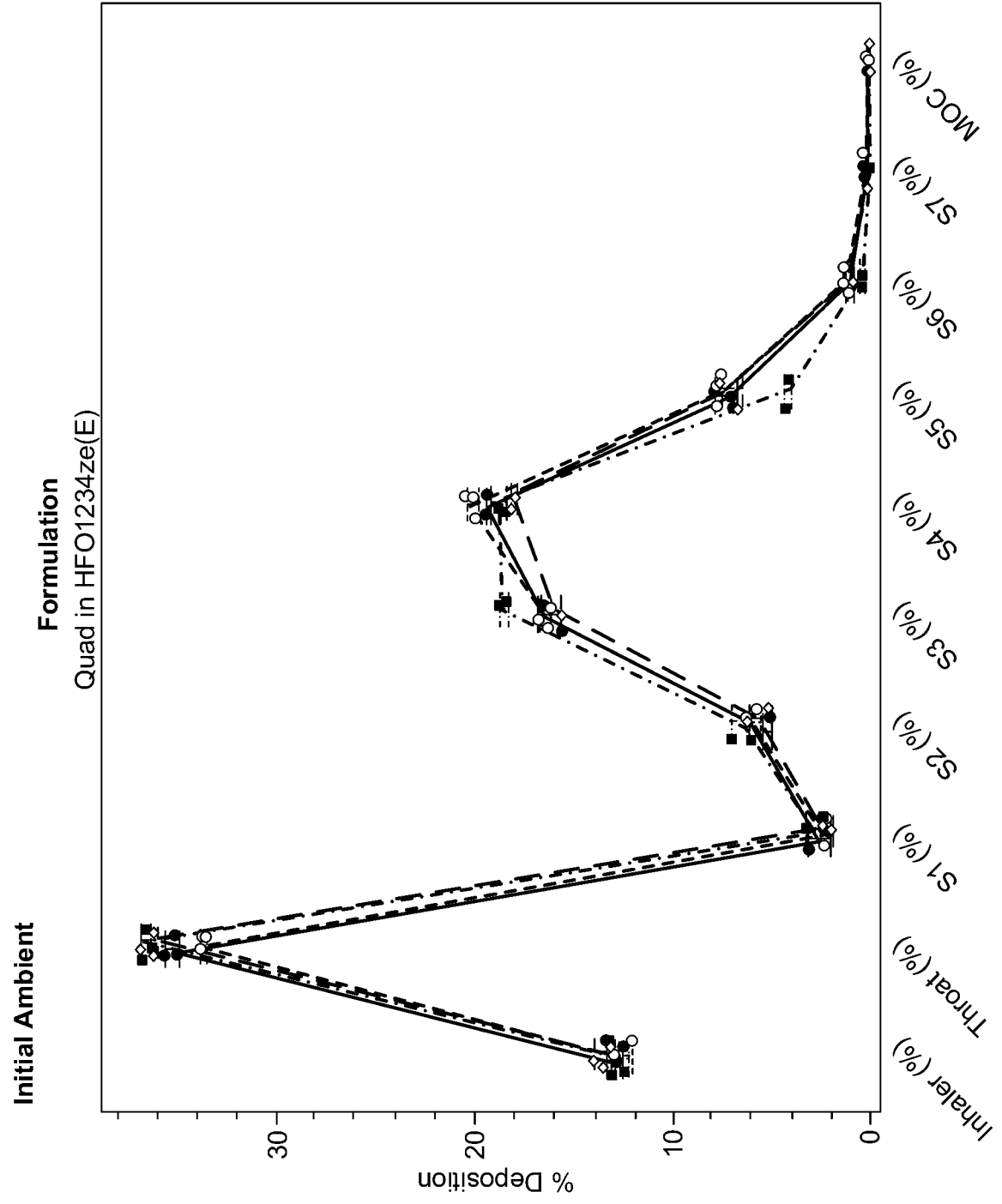


FIG. 30

41/63

Stability Condition  
— Initial Ambient  
- - - 1.5M Accelerated Stability  
- · - · - 3M Real-time Stability  
- - - 3M Accelerated Stability

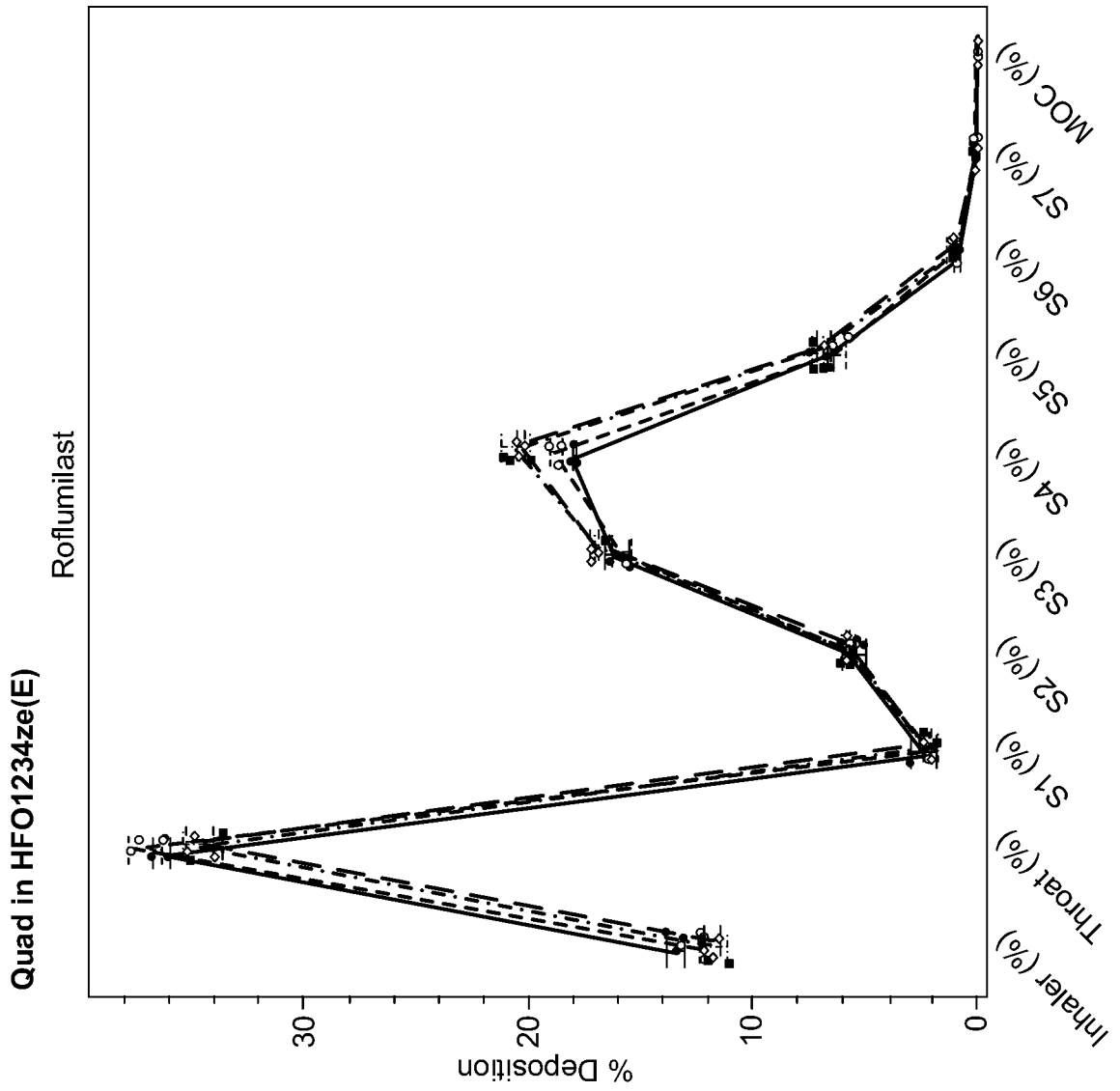


FIG. 31A

42/63

Stability Condition  
● Initial Ambient  
○ 1.5M Accelerated Stability  
■ 3M Real-time Stability  
◇ 3M Accelerated Stability

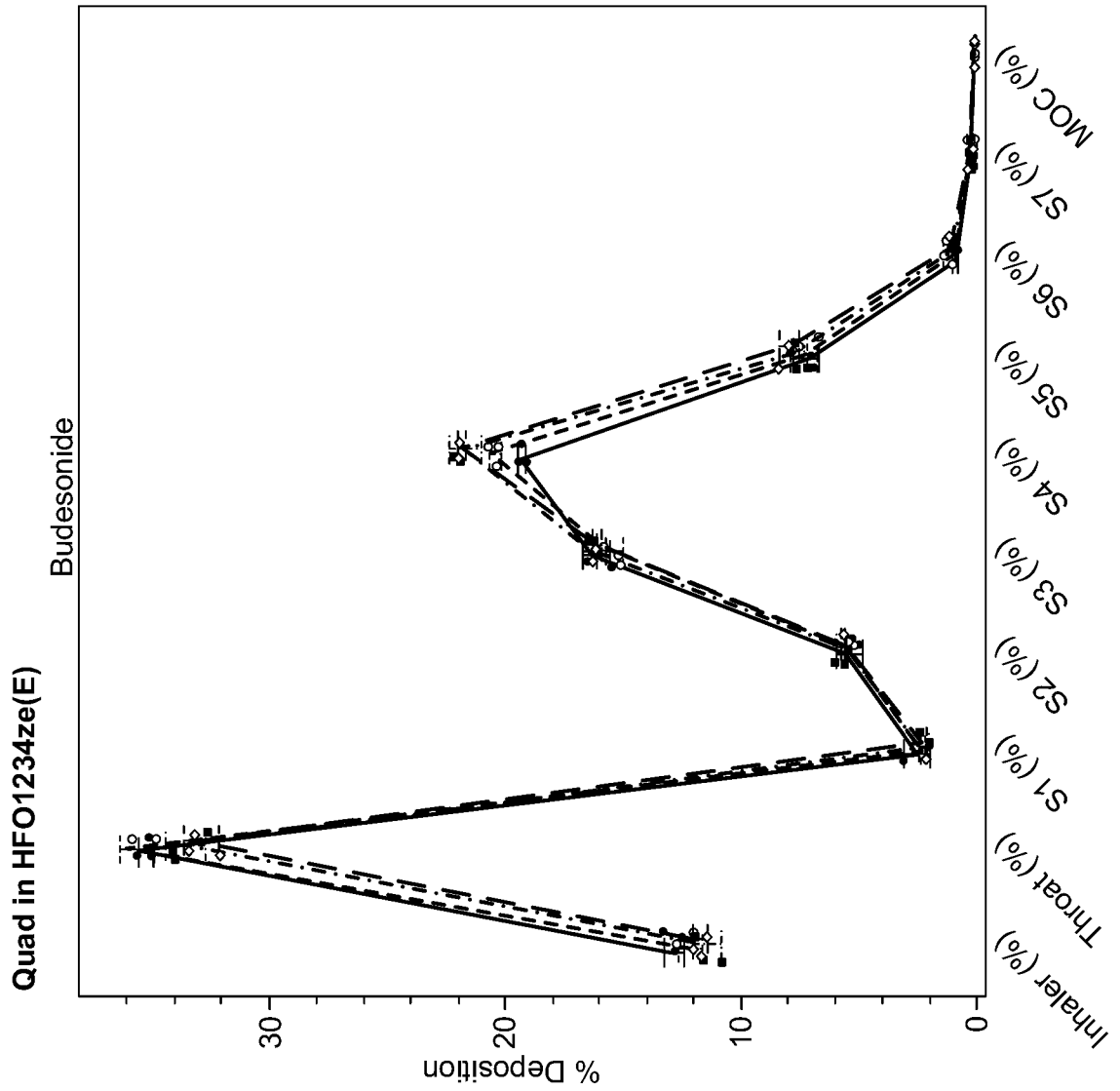


FIG. 31B

43/63

Stability Condition  
● Initial Ambient  
○ 1.5M Accelerated Stability  
■ 3M Real-time Stability  
◇ 3M Accelerated Stability

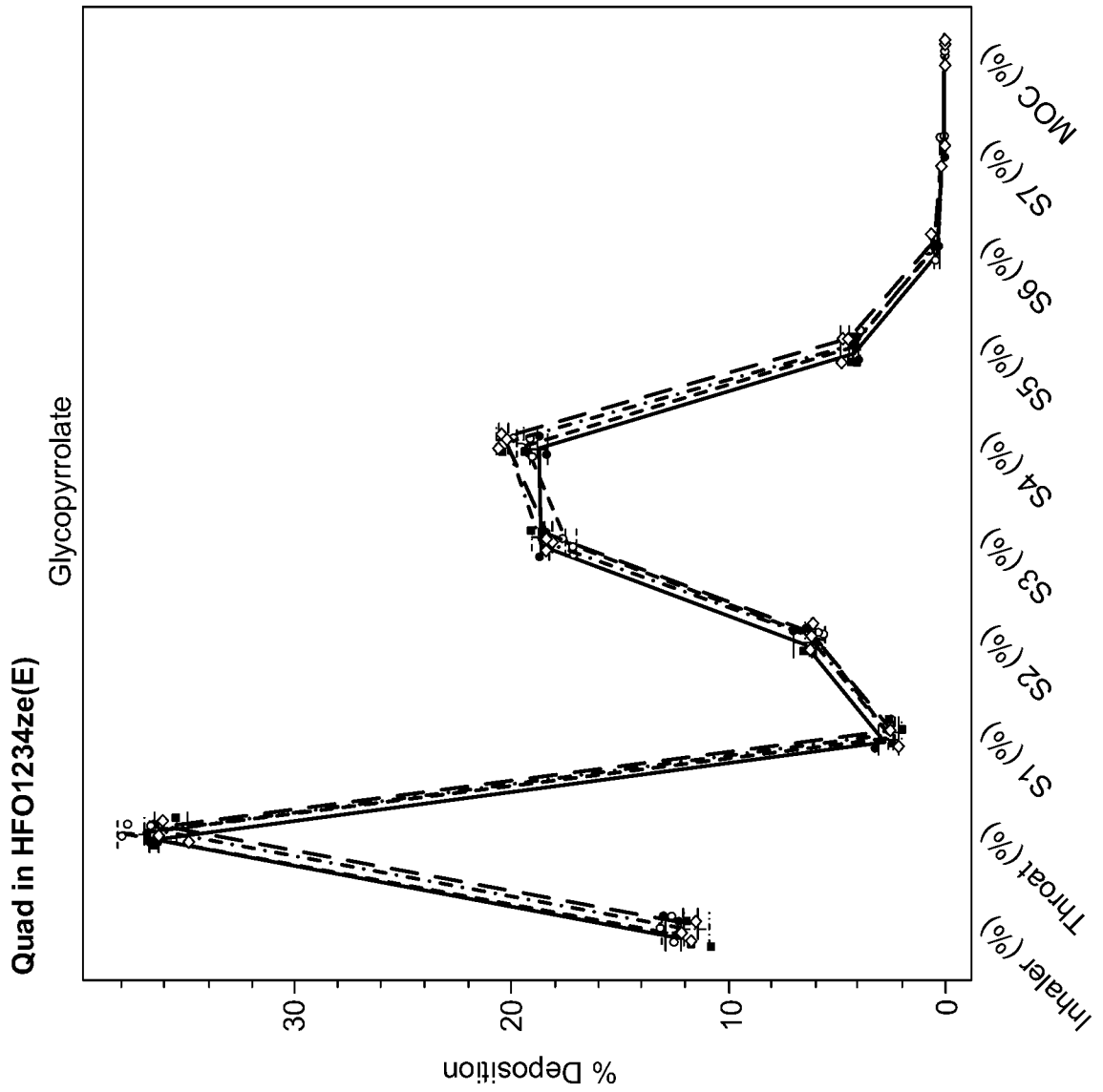


FIG. 31C

44/63

Stability Condition  
● Initial Ambient  
○ 1.5M Accelerated Stability  
■ 3M Real-time Stability  
◇ 3M Accelerated Stability

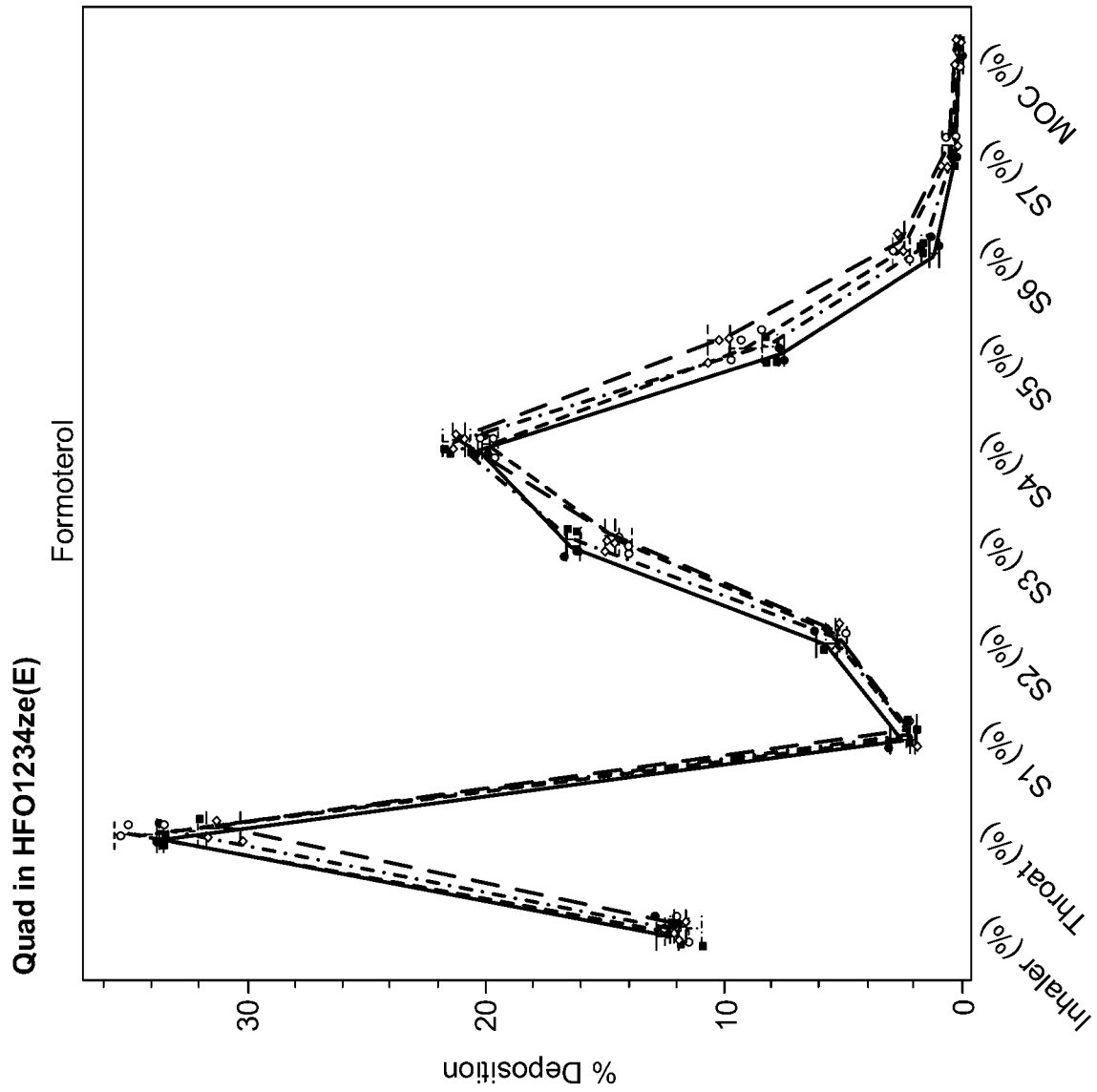
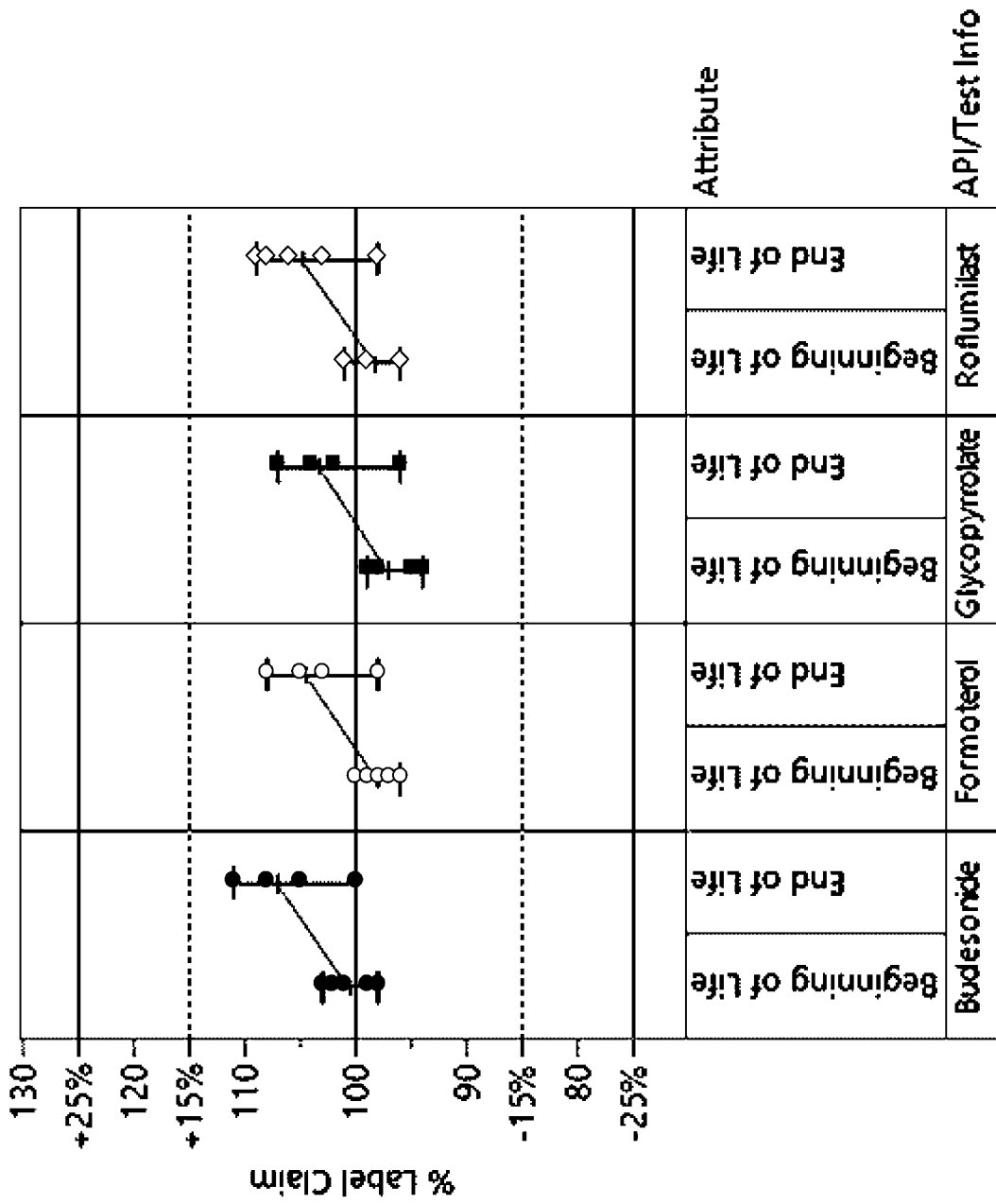


FIG. 31D

45/63

**API/Test Info**  
 ● Budesonide  
 ○ Formoterol  
 ■ Glycopyrrolate  
 ◇ Roflumilast

**FIG. 32**



Attribute

API/Test Info

46/63

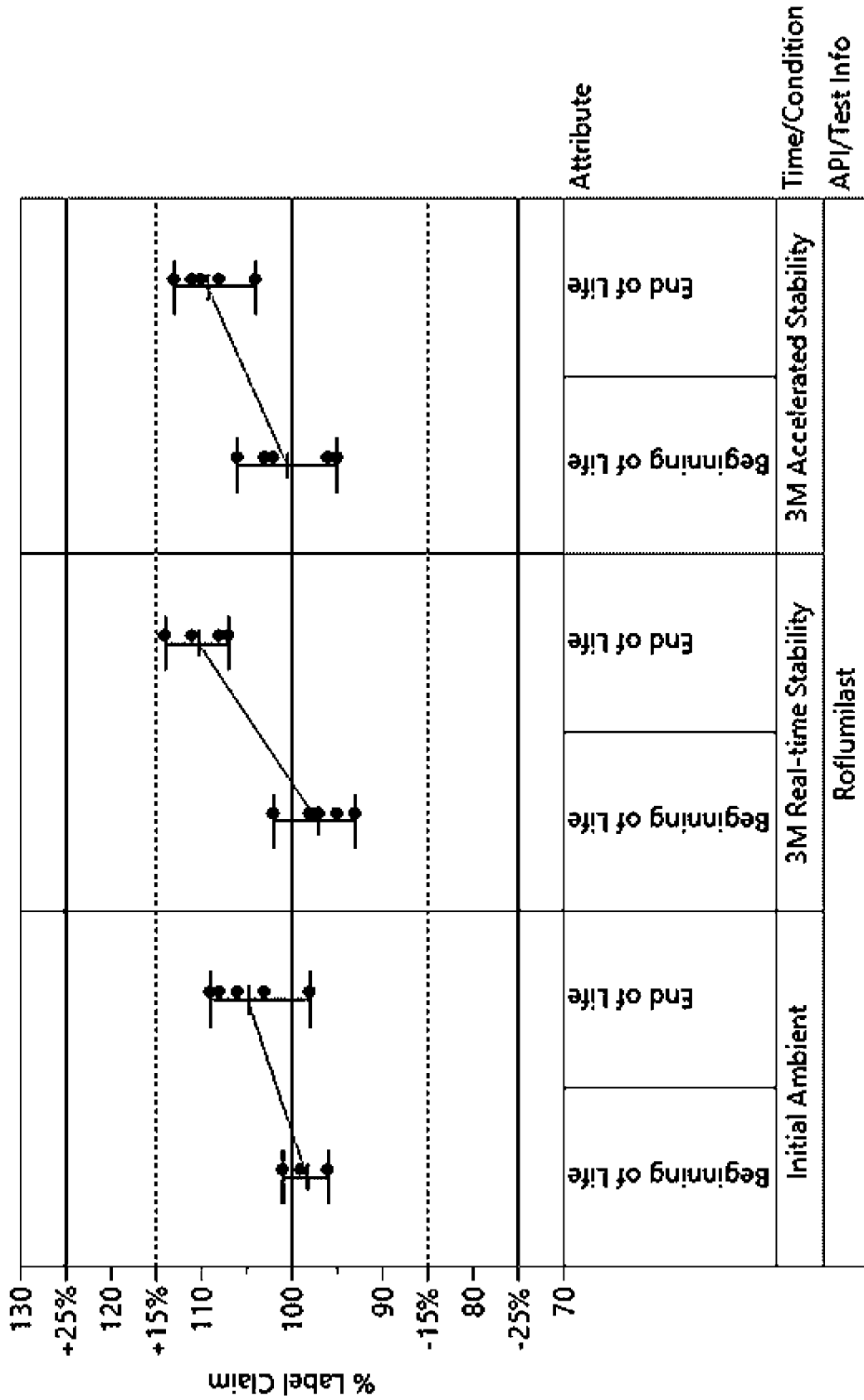


FIG. 33A

47/63

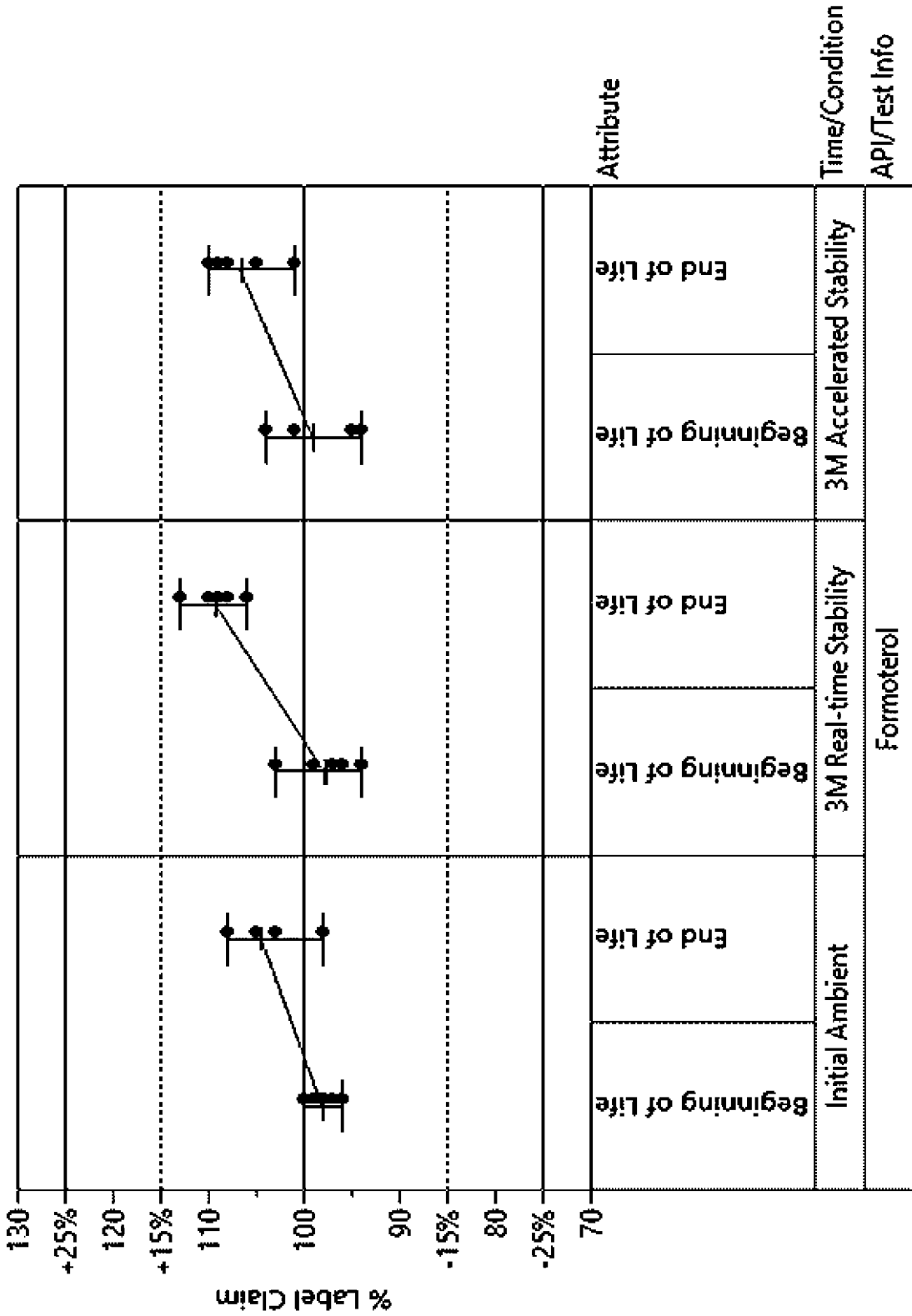


FIG. 33B

48/63

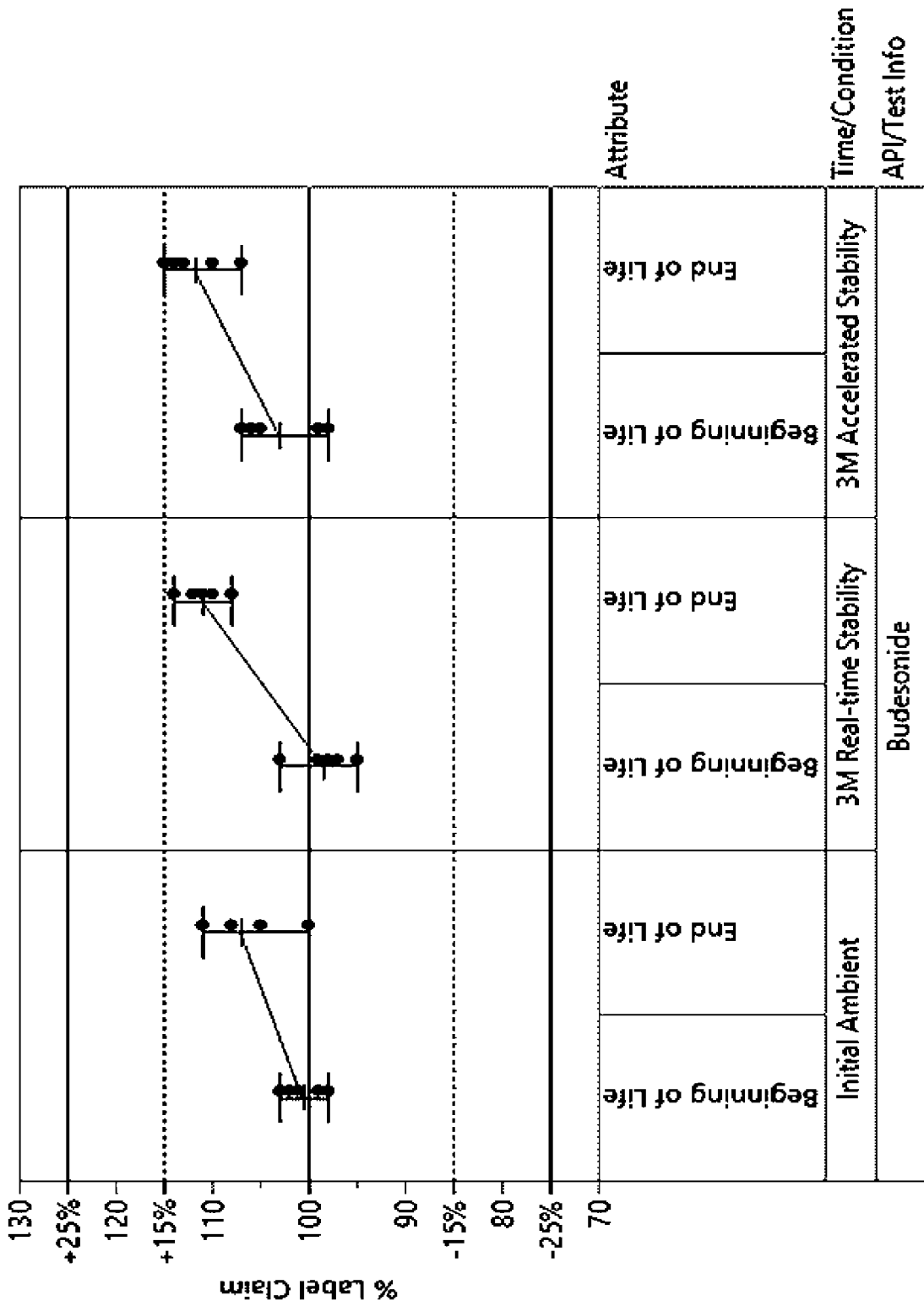


FIG. 33C

49/63

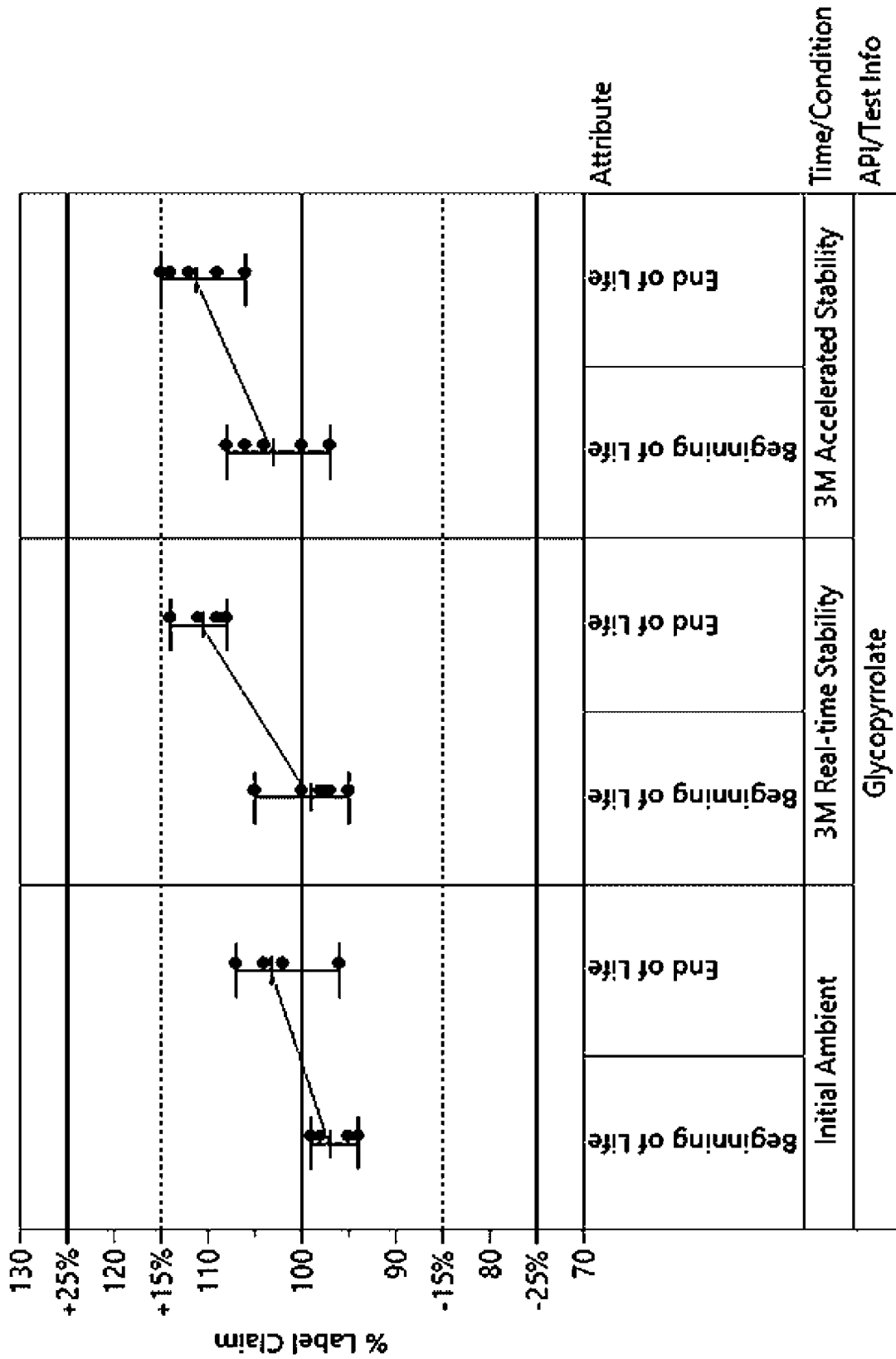


FIG. 33D

50/63

API/Test Info  
● Budesonide  
○ Formoterol  
■ Glycopyrrolate  
◇ Roflumilast

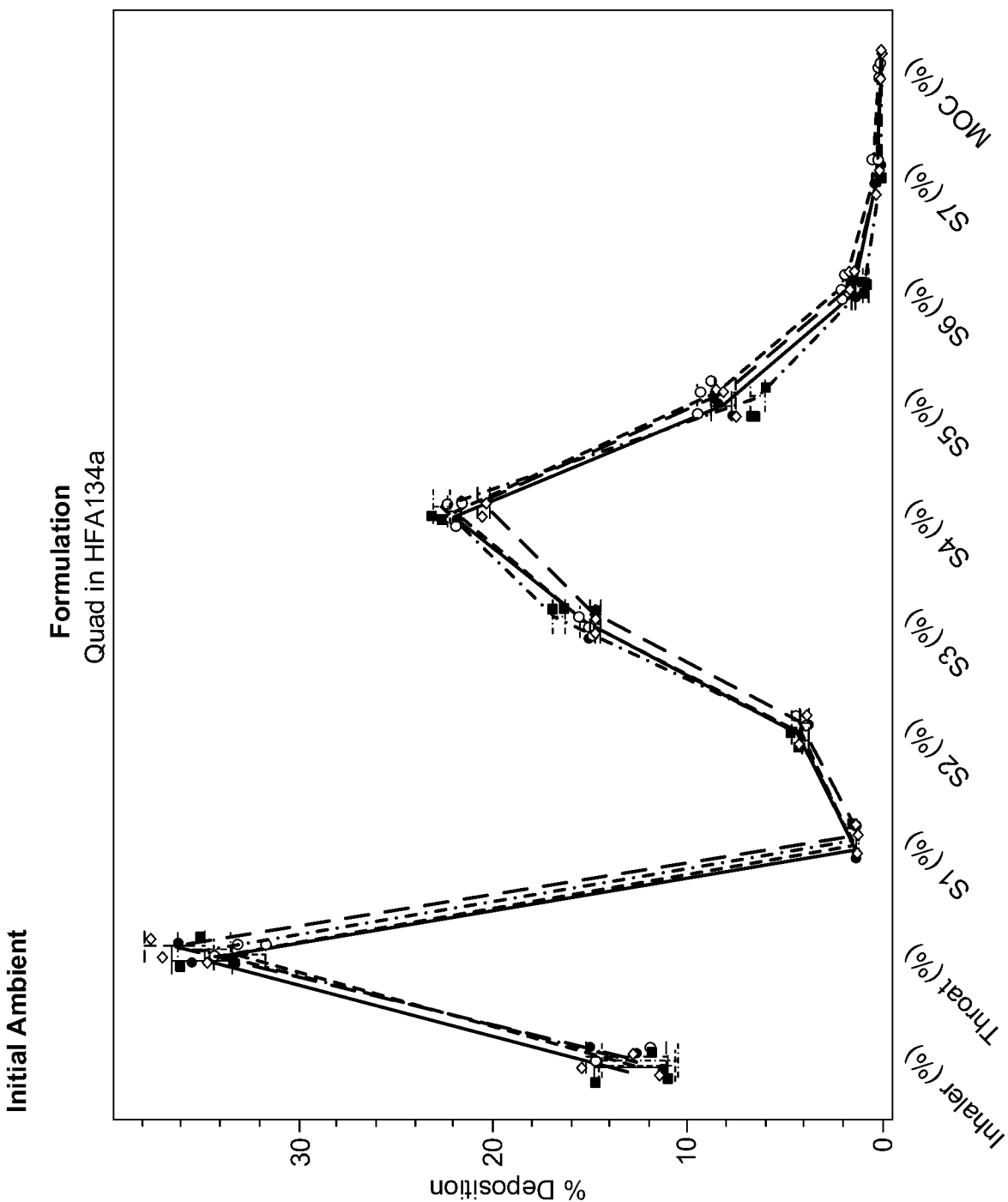


FIG. 34

51/63

Stability Condition  
● Initial Ambient  
○ 1.5M Accelerated Stability  
■ 3M Real-time Stability  
◇ 3M Accelerated Stability

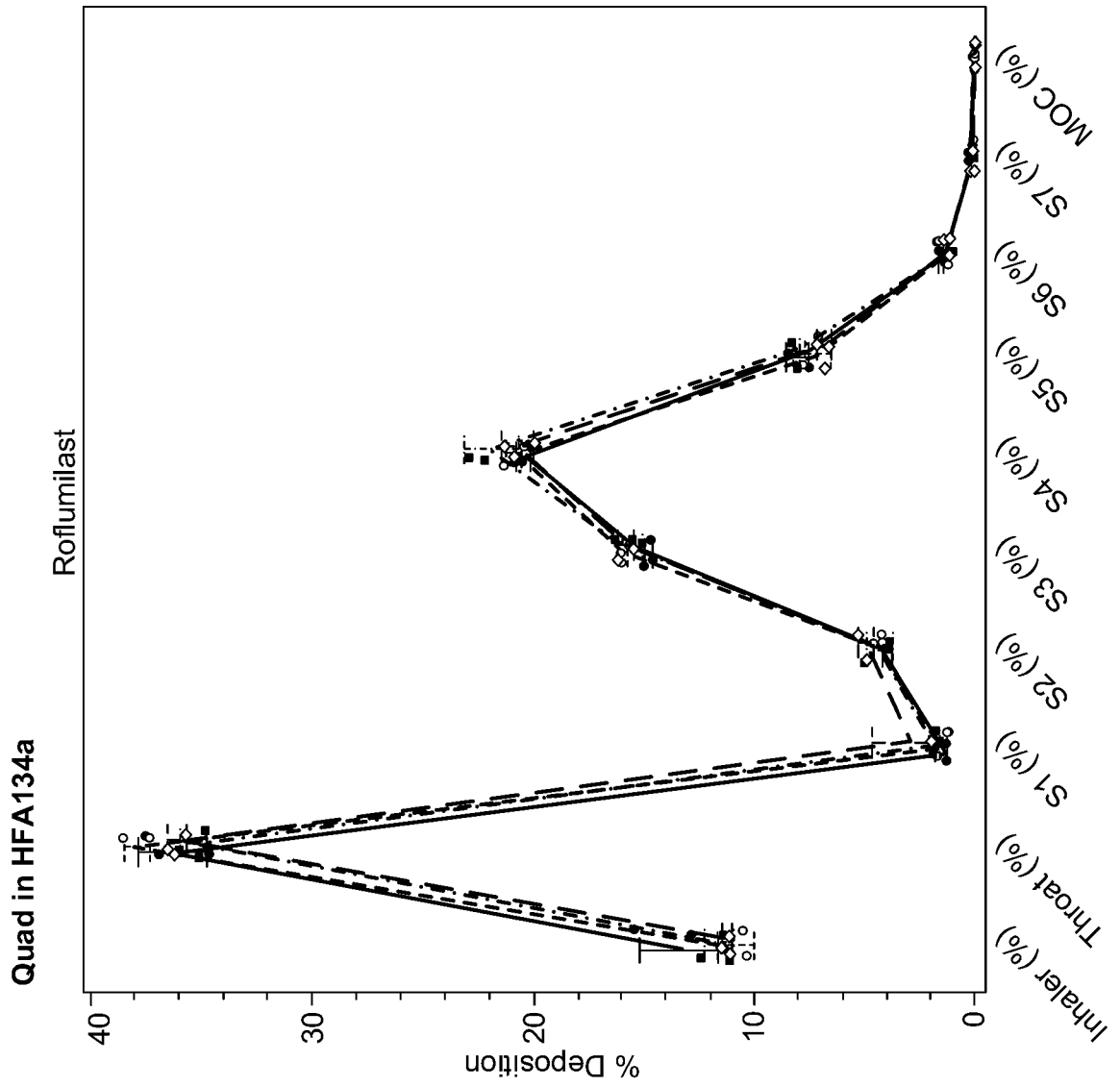


FIG. 35A

52/63

Stability Condition  
● Initial Ambient  
○ 1.5M Accelerated Stability  
■ 3M Real-time Stability  
◇ 3M Accelerated Stability

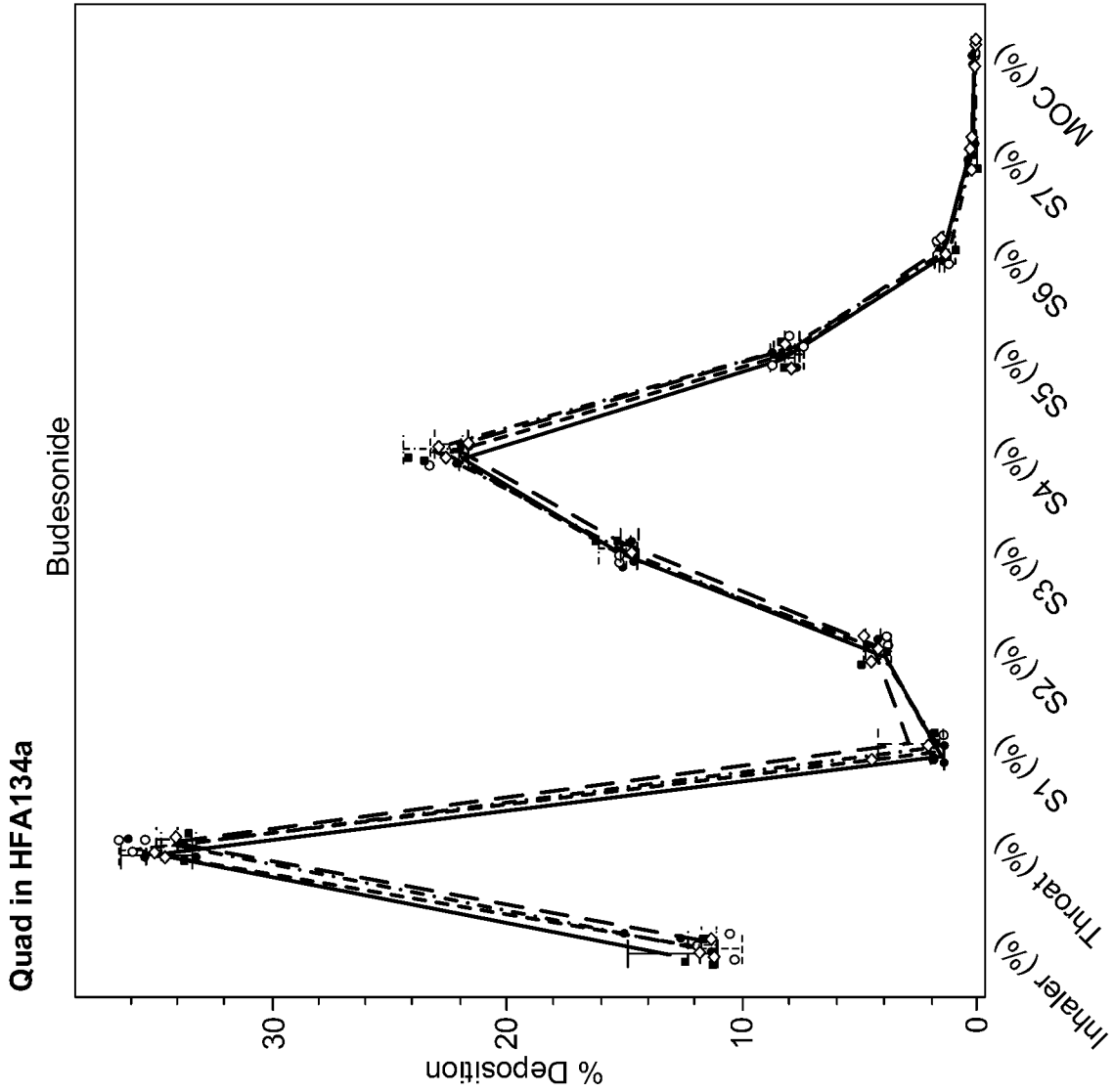


FIG. 35B

53/63

Stability Condition  
● Initial Ambient  
○ 1.5M Accelerated Stability  
■ 3M Real-time Stability  
◇ 3M Accelerated Stability

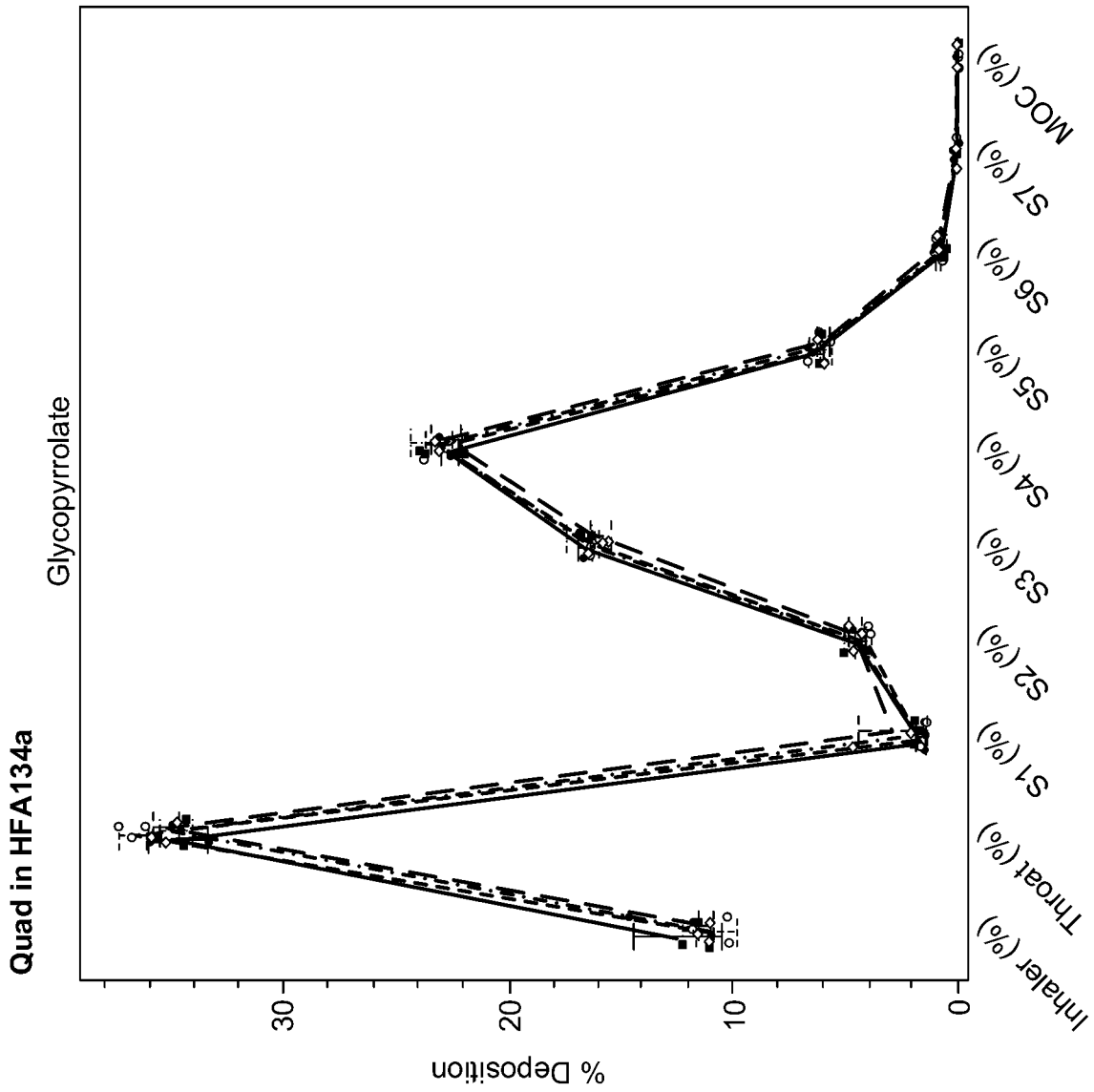


FIG. 35C

54/63

Stability Condition  
● Initial Ambient  
○ 1.5M Accelerated Stability  
■ 3M Real-time Stability  
◇ 3M Accelerated Stability

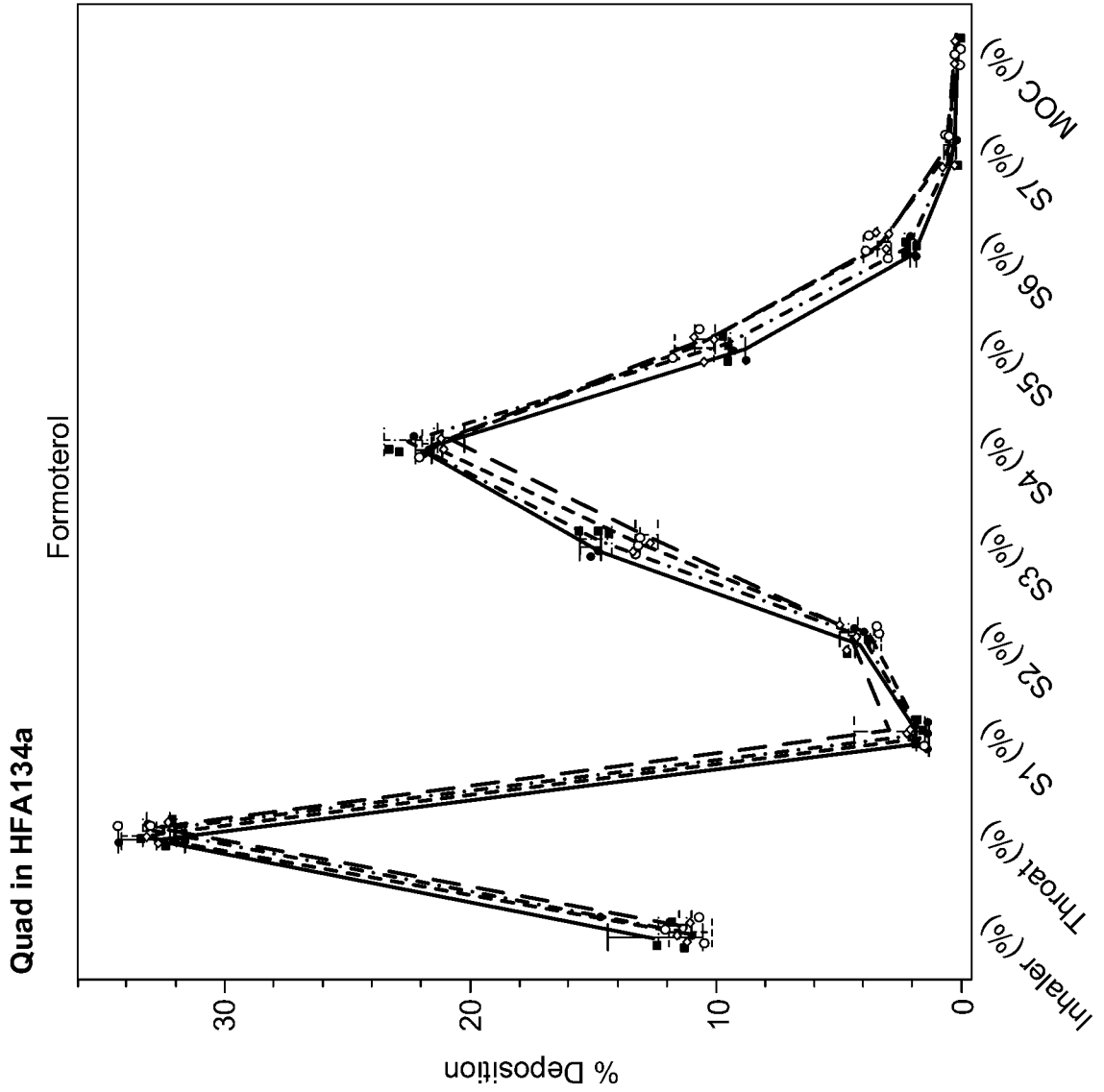


FIG. 35D

55/63

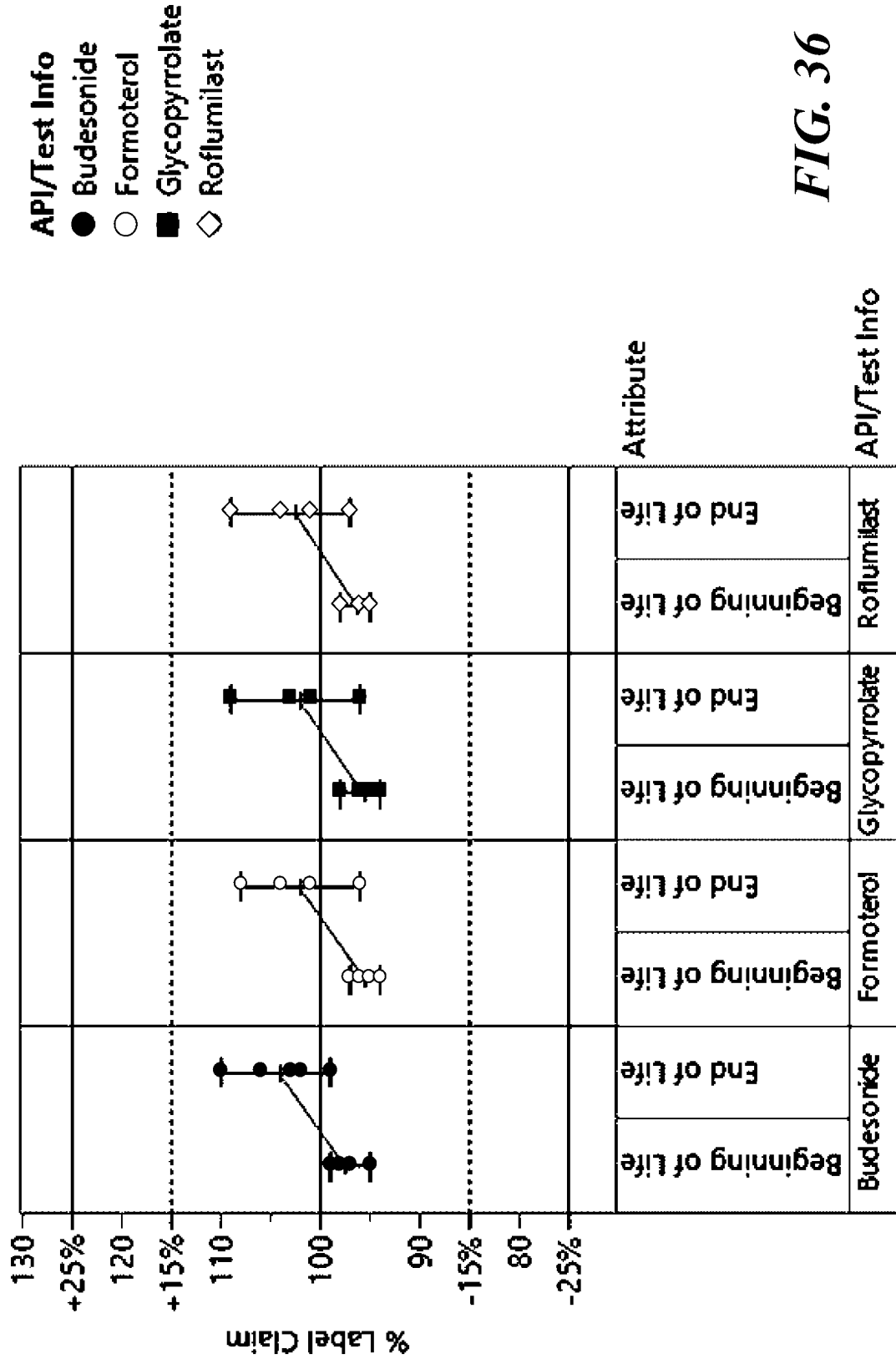


FIG. 36

56/63

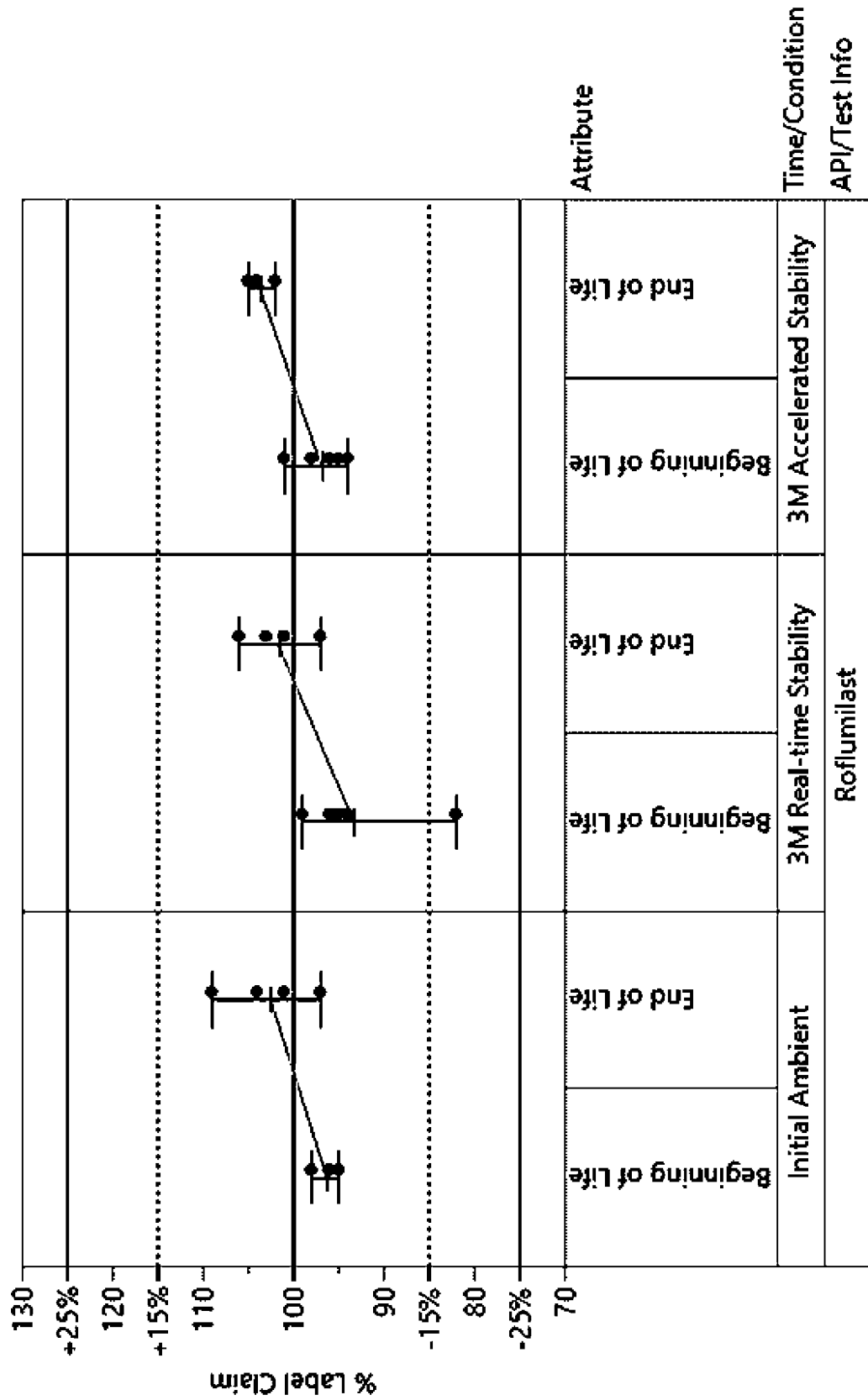


FIG. 37A

57/63

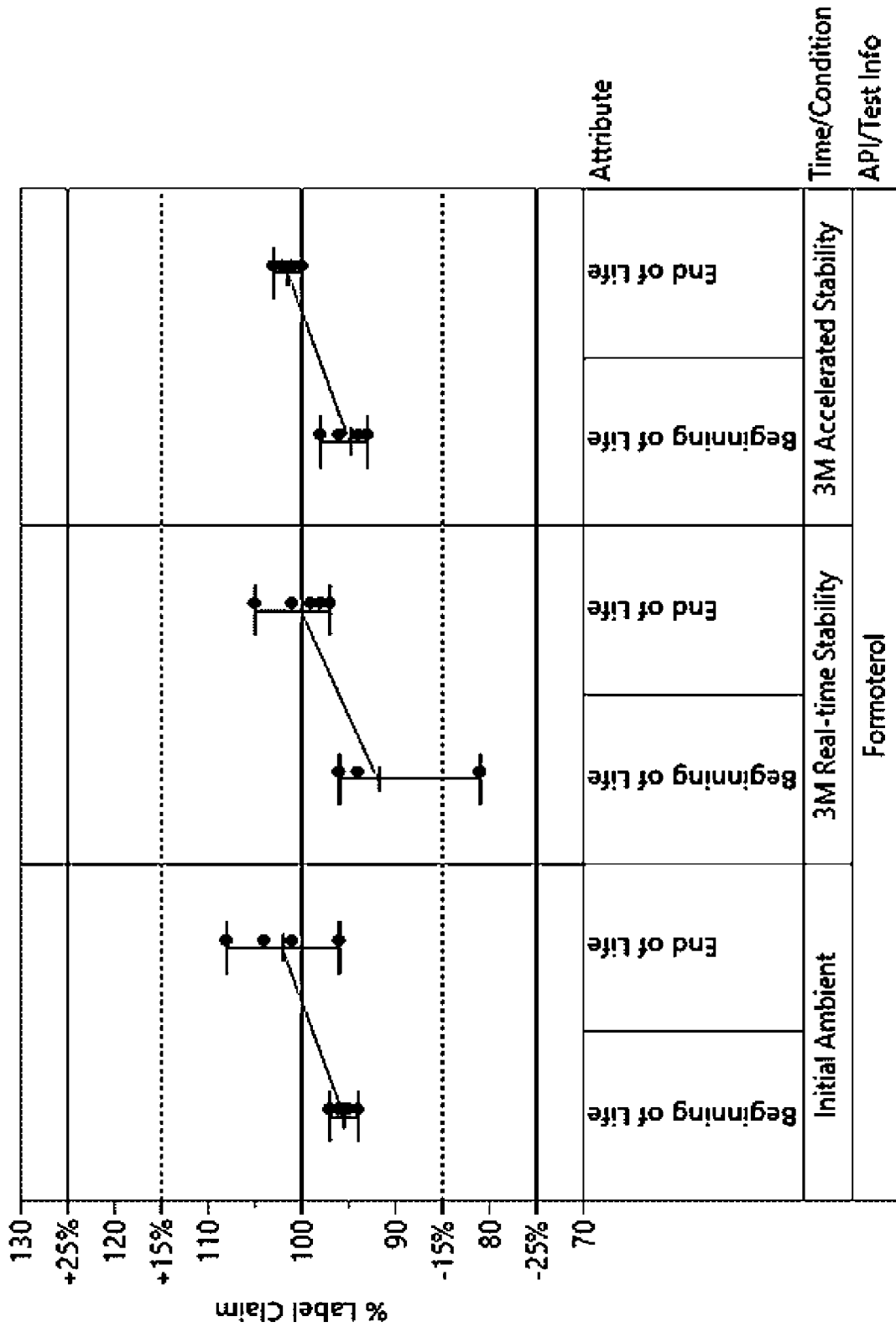
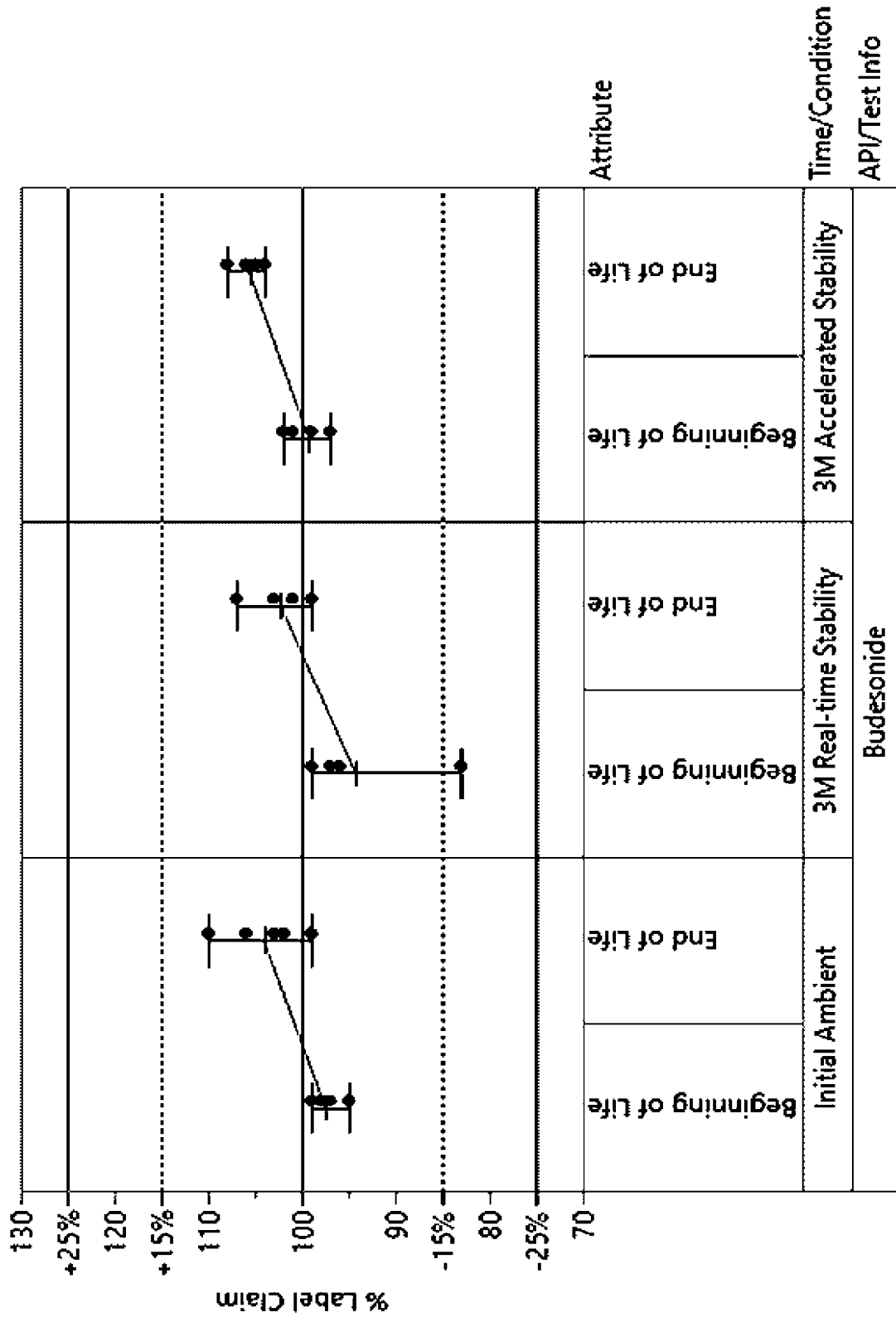


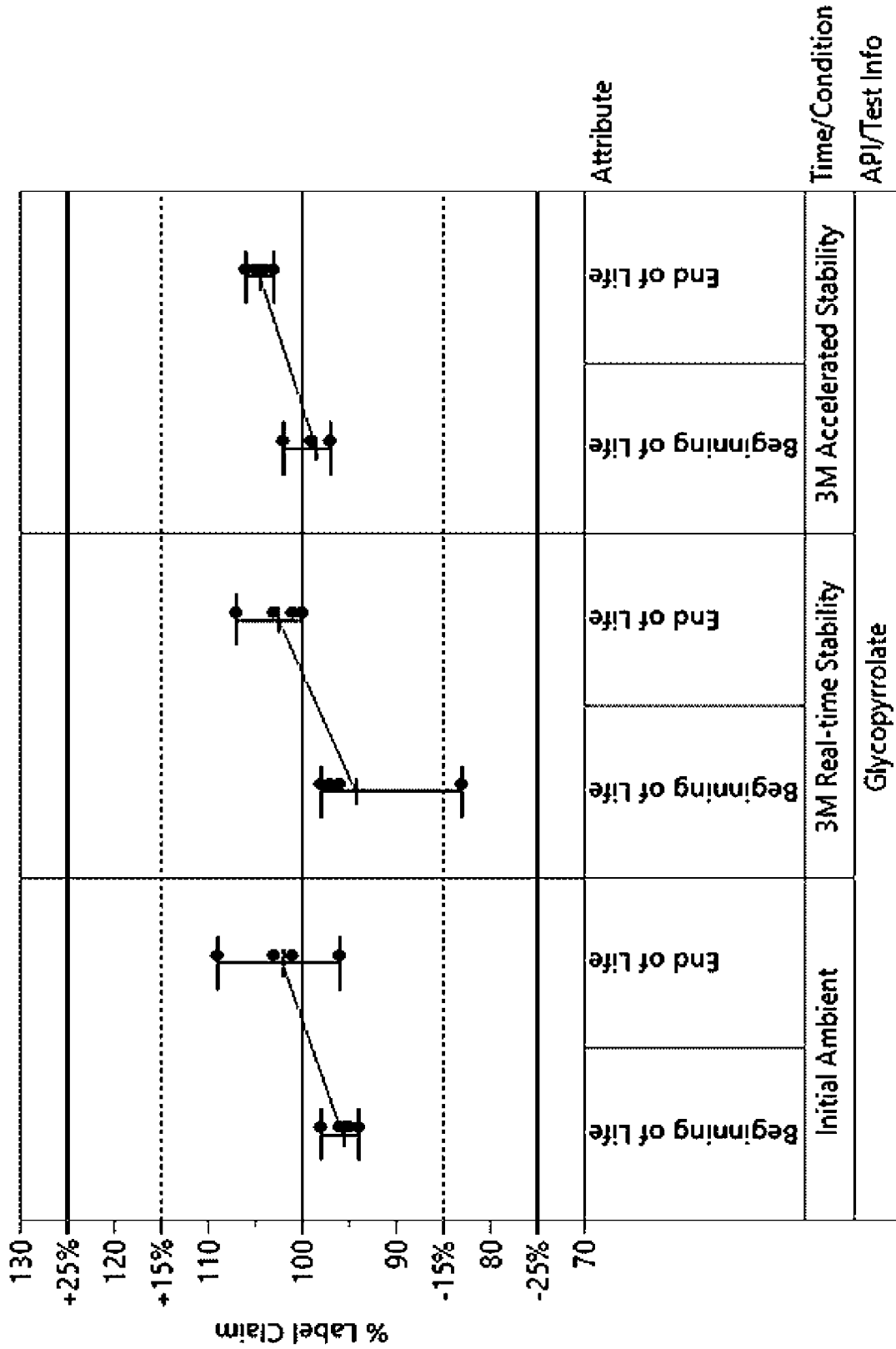
FIG. 37B

58/63



**FIG. 37C**

59/63



**FIG. 37D**

60/63

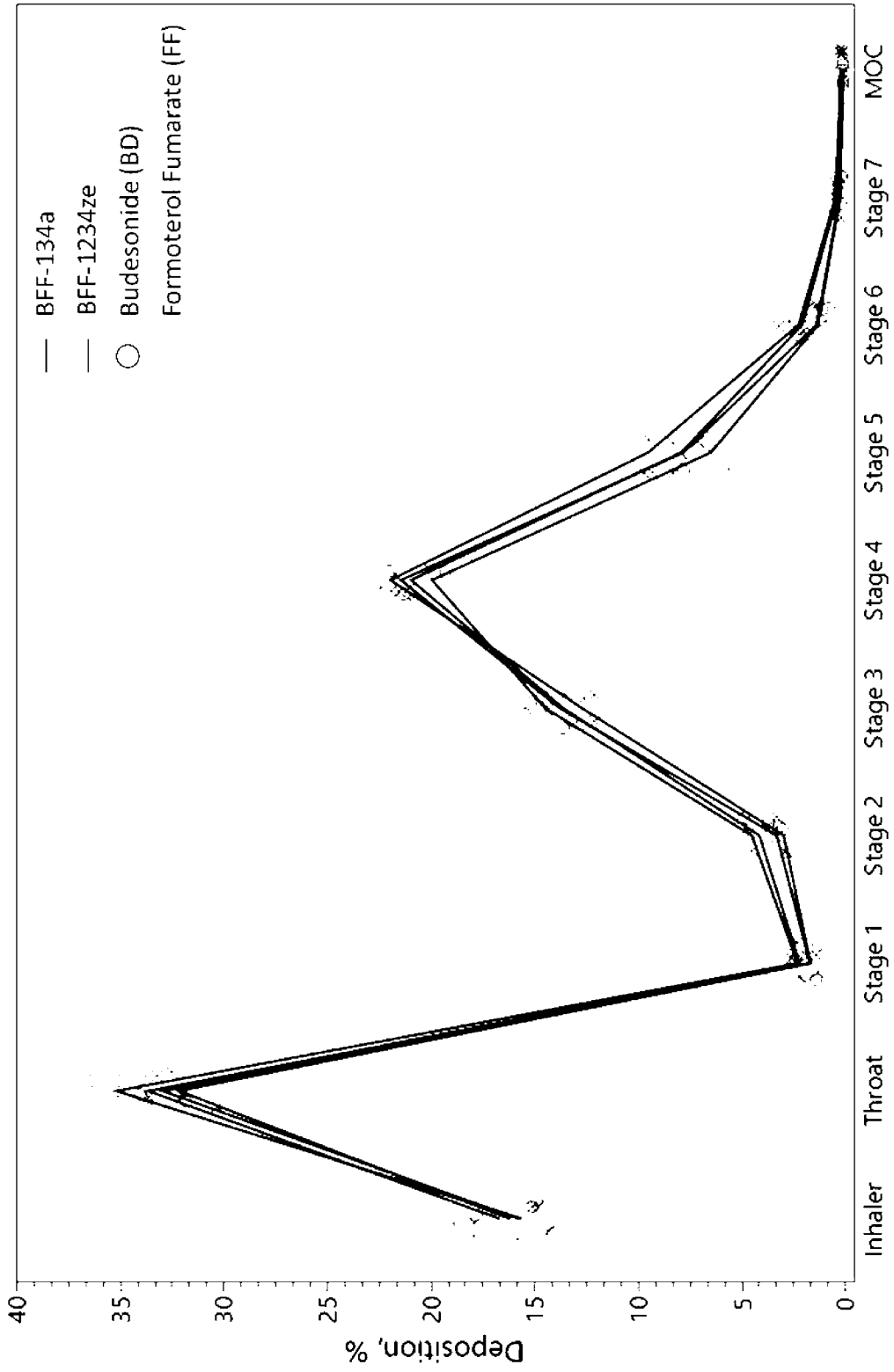


FIG. 38

61/63

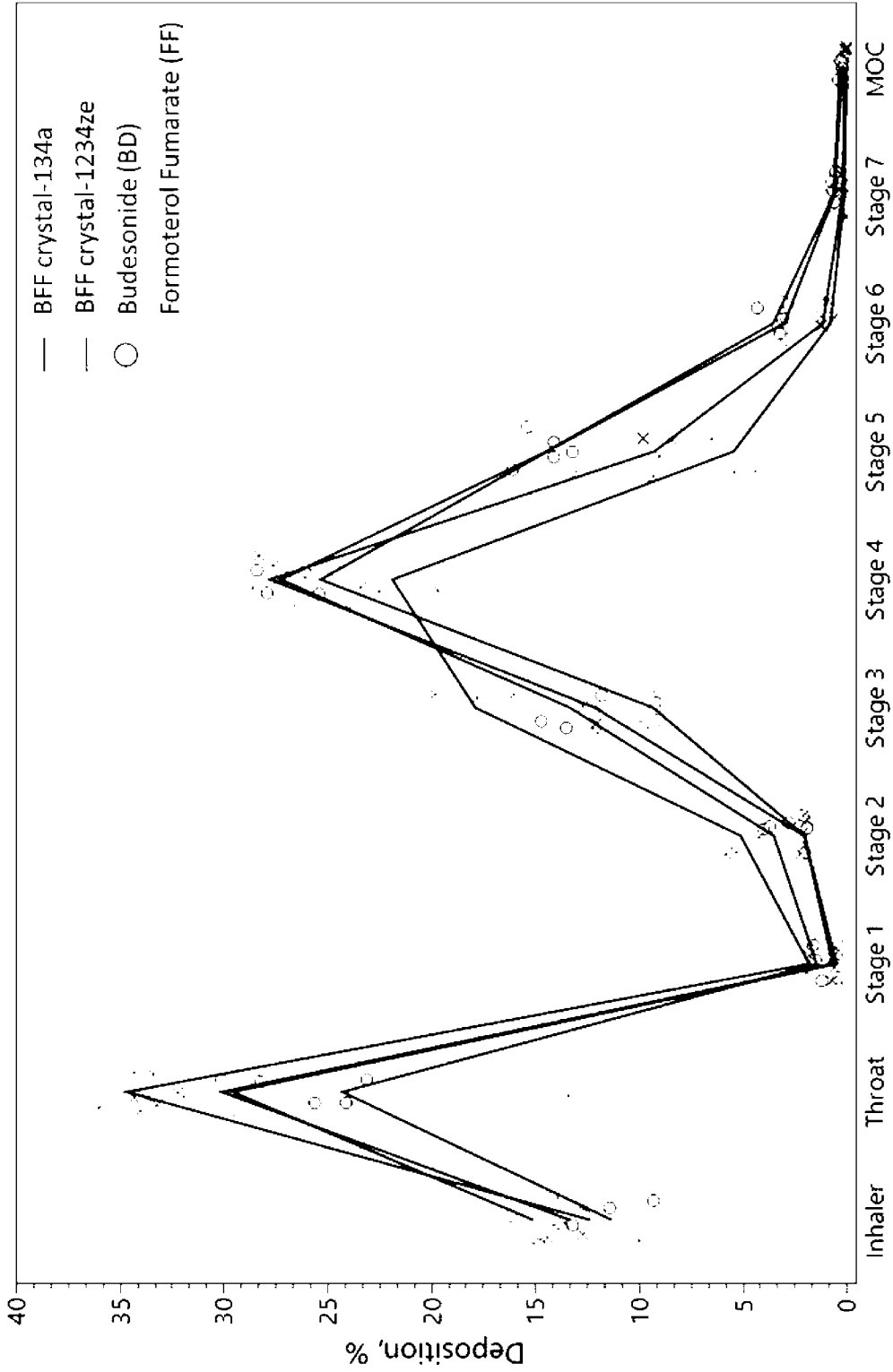
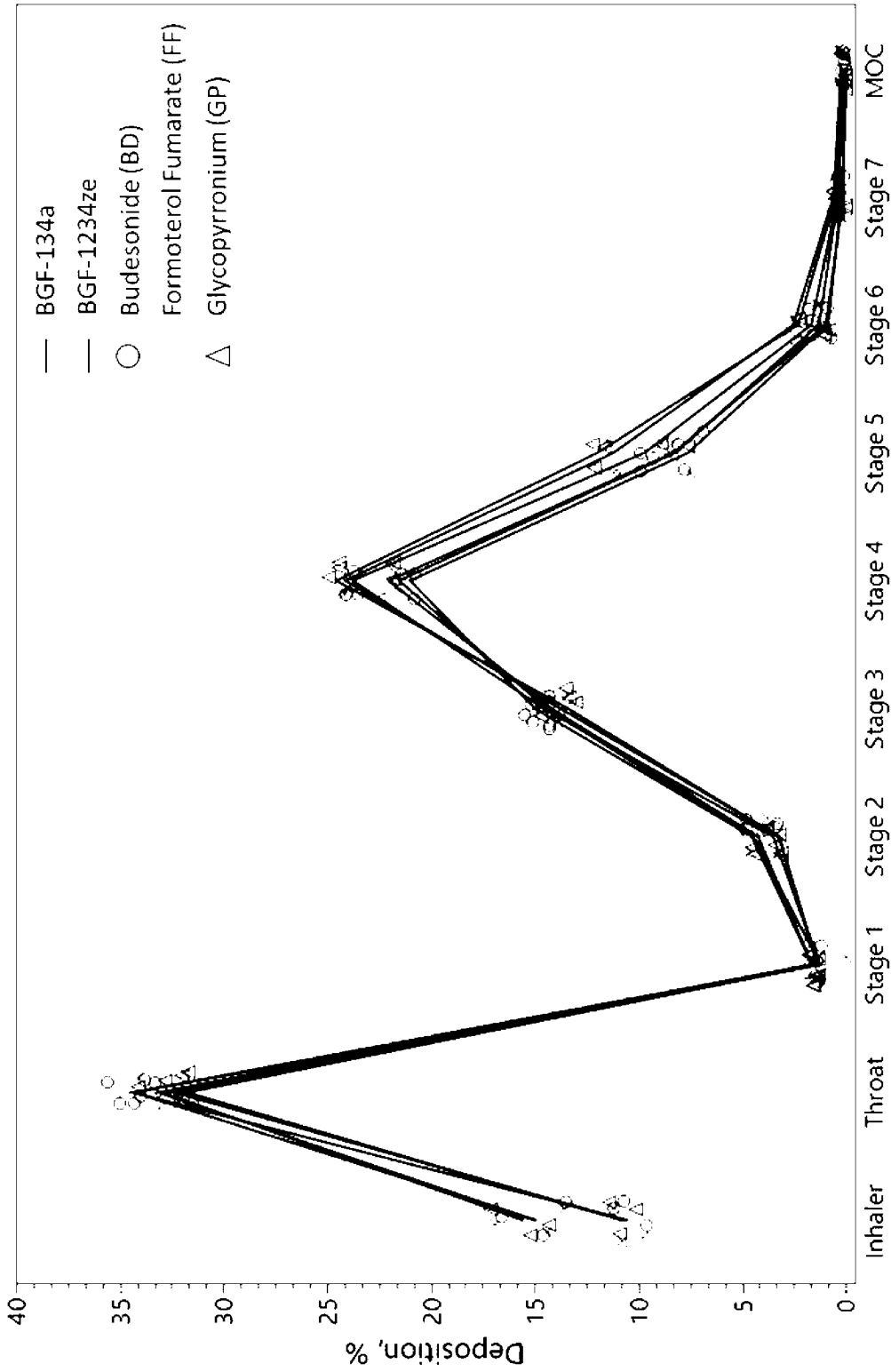


FIG. 39

62/63



**FIG. 40**

63/63

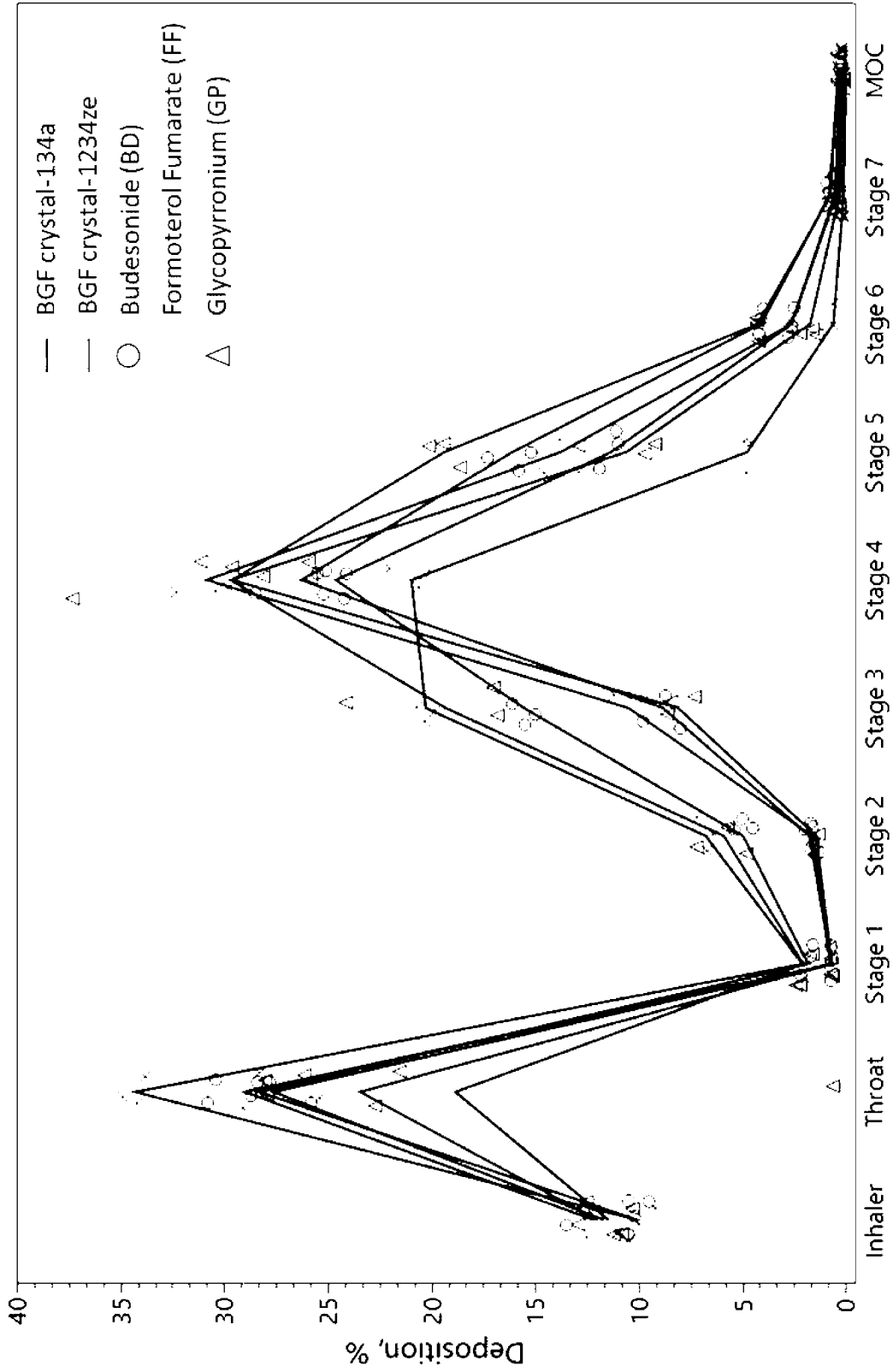
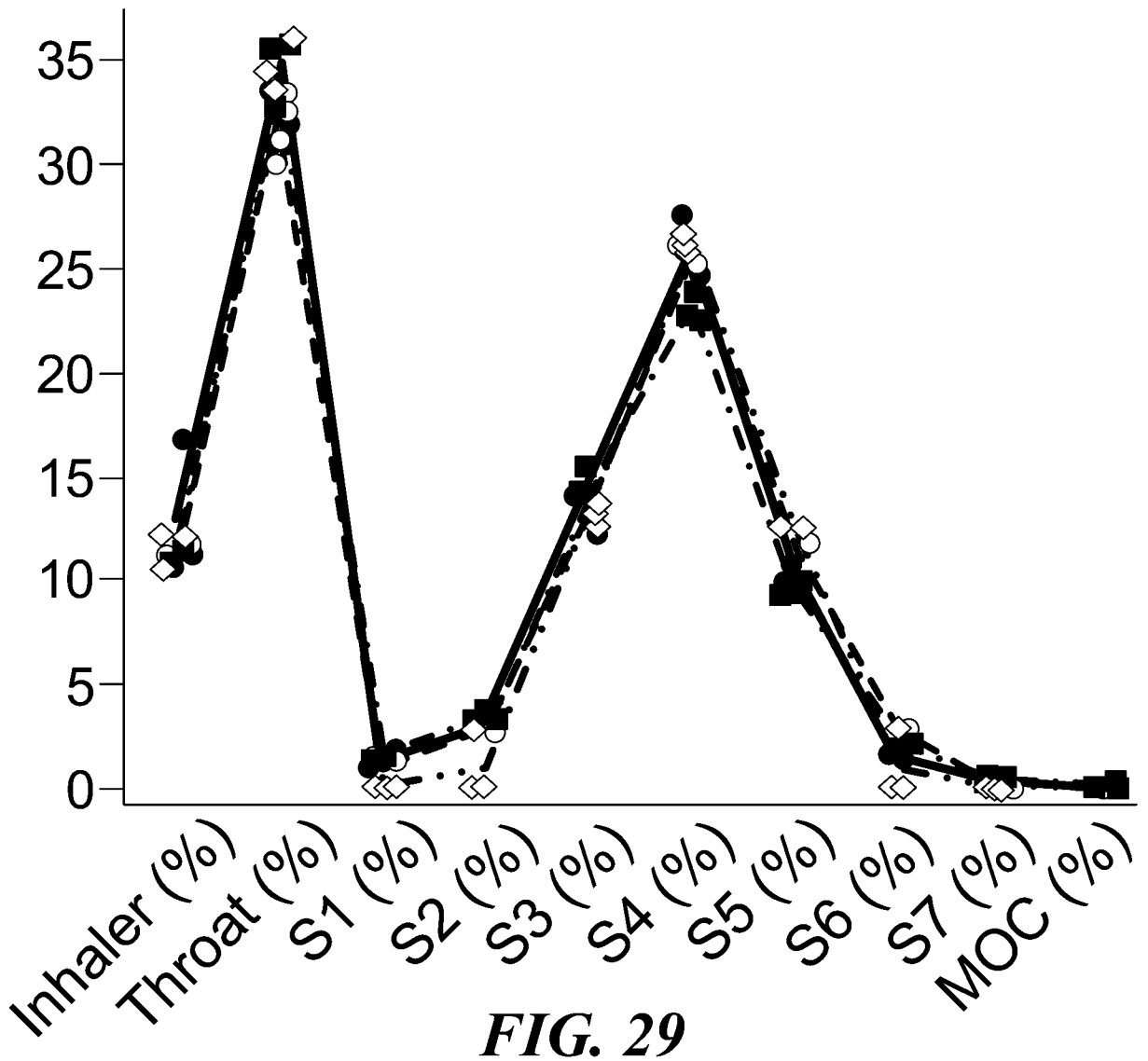


FIG. 41



**FIG. 29**