



US00D507654S

(12) **United States Design Patent** (10) **Patent No.:** **US D507,654 S**
Gollnick et al. (45) **Date of Patent:** **** Jul. 19, 2005**

(54) **TREATMENT HANDPIECE**

OTHER PUBLICATIONS

(75) Inventors: **David A. Gollnick**, San Francisco, CA (US); **Teresa I. Villegas**, Milpitas, CA (US); **Fadhly Bey**, San Francisco, CA (US); **Kelly Kodama**, Alamo, CA (US)

2003 Editors Choice Awards ATnT Award, Winter 2003, vol. 2, issue 5 (total pages 2).

Skin Rejuvenation and Pigmented Lesions, Xeo SA, Adding Intelligence to Pulsed Light tm, Cutera, dated ©2004, but note that it is believed that the design of the handpiece shown on p. 3 of this brochure document, was on sale more than a year prior to the filing date of the present application (total pp. 4).

(73) Assignee: **Cutera, Inc.**, Brisbane, CA (US)

(**) Term: **14 Years**

* cited by examiner

(21) Appl. No.: **29/207,186**

Primary Examiner—Cathy Anne MacCormac

Assistant Examiner—Melanie Levy

(22) Filed: **Jun. 9, 2004**

(74) *Attorney, Agent, or Firm*—Stallman & Pollock LLP

(51) **LOC (8) Cl.** **28-03**

(52) **U.S. Cl.** **D24/210; D24/200**

(58) **Field of Search** D24/133, 200, D24/209, 210; 607/88, 90, 93; 362/19, 109, 264, 294, 298, 345, 373, 396, 399, 577

(57) **CLAIM**

The ornamental design for the treatment handpiece, as shown and described.

(56) **References Cited**

DESCRIPTION

U.S. PATENT DOCUMENTS

D90,125	S	*	6/1933	Prouty	D24/210
D133,969	S	*	9/1942	Warren	D24/210
4,249,233	A	*	2/1981	Gatton	362/109
D400,258	S	*	10/1998	Bolleter	D24/210
D432,659	S	*	10/2000	Bolleter	D24/210
D441,456	S	*	5/2001	Thiberg	D24/210
D477,664	S	*	7/2003	Wong	D24/133
2005/0015121	A1	*	1/2005	Molina	607/88

FIG. 1 is a perspective view of a treatment handpiece showing my design;

FIG. 2 is a right side elevational view thereof with the left side being a mirror image;

FIG. 3 is a front elevational view thereof;

FIG. 4 is a rear elevational view thereof;

FIG. 5 is a top plan view thereof; and,

FIG. 6 is a bottom plan view thereof.

1 Claim, 3 Drawing Sheets

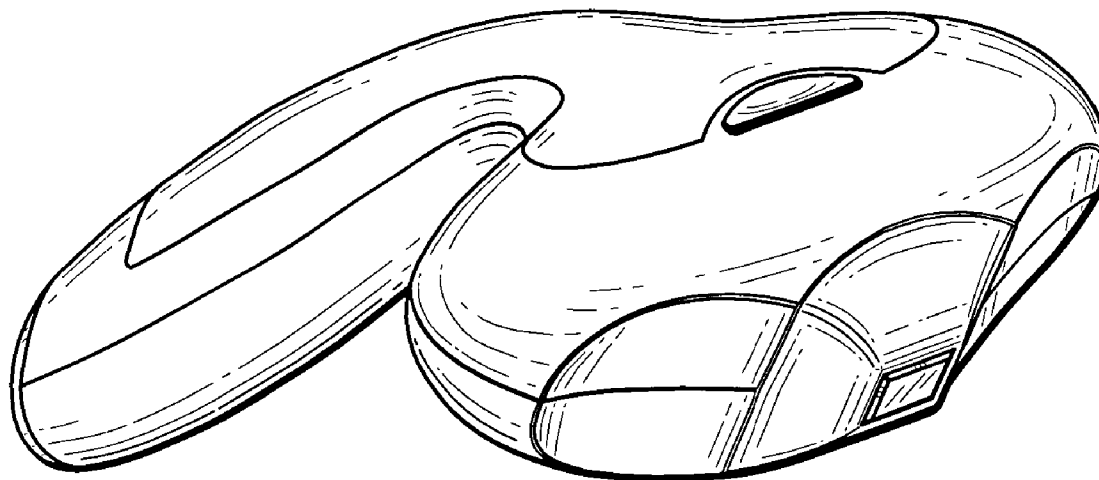

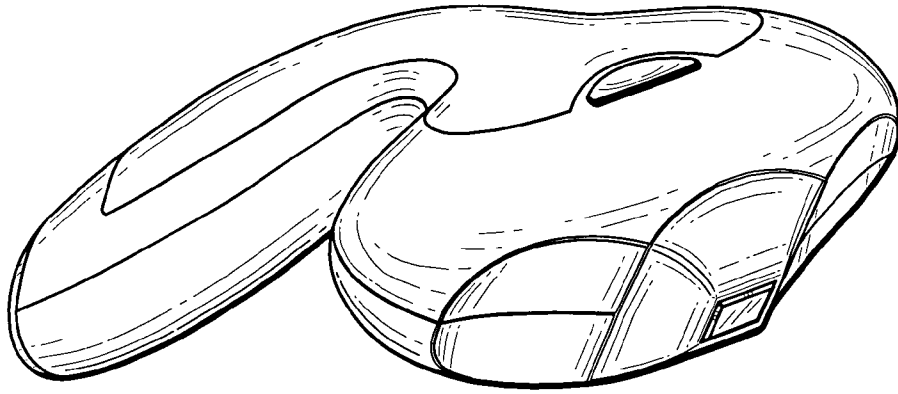

FIG. 1

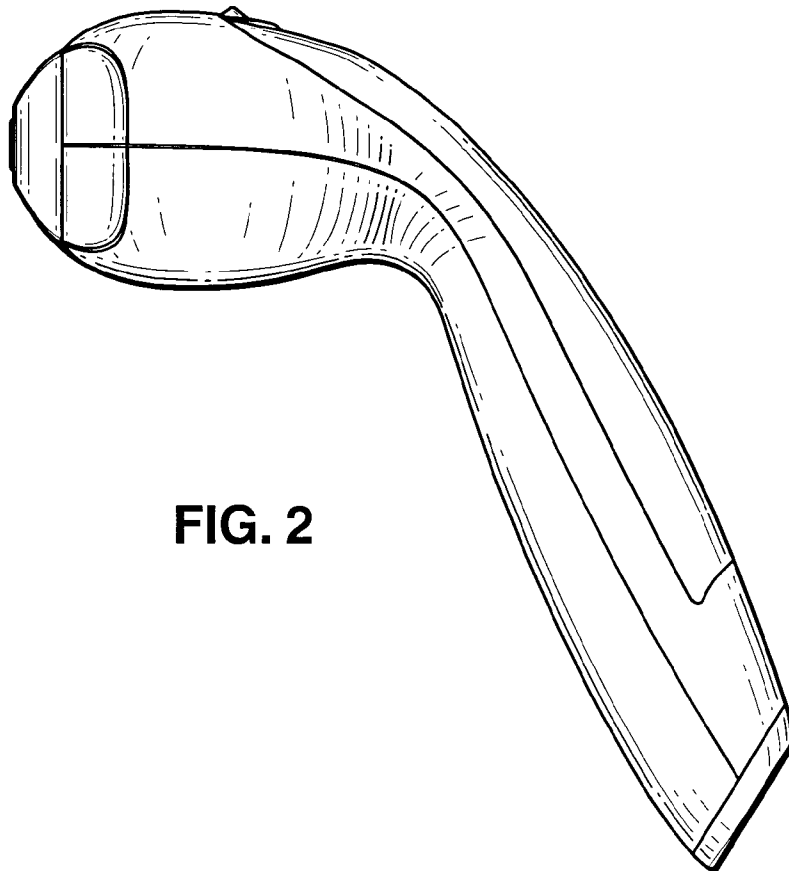

FIG. 2

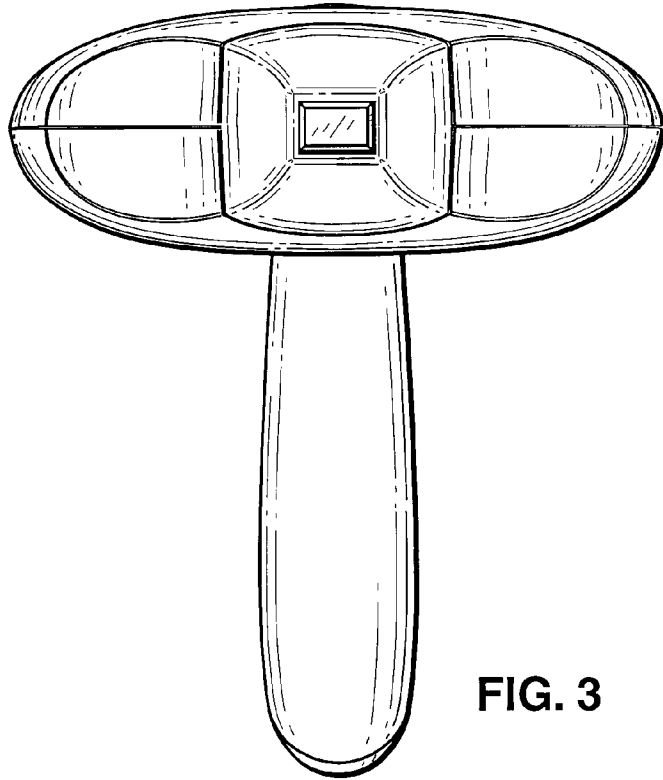

FIG. 3

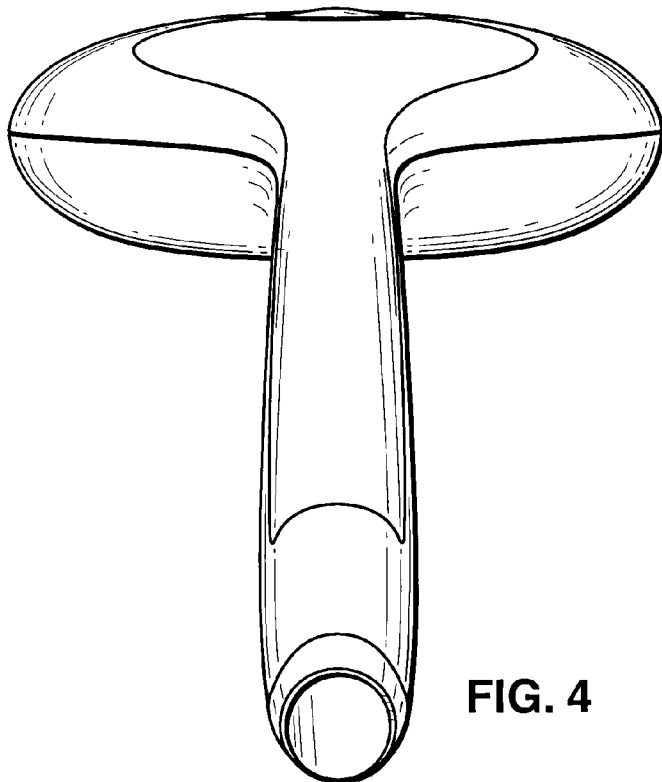

FIG. 4

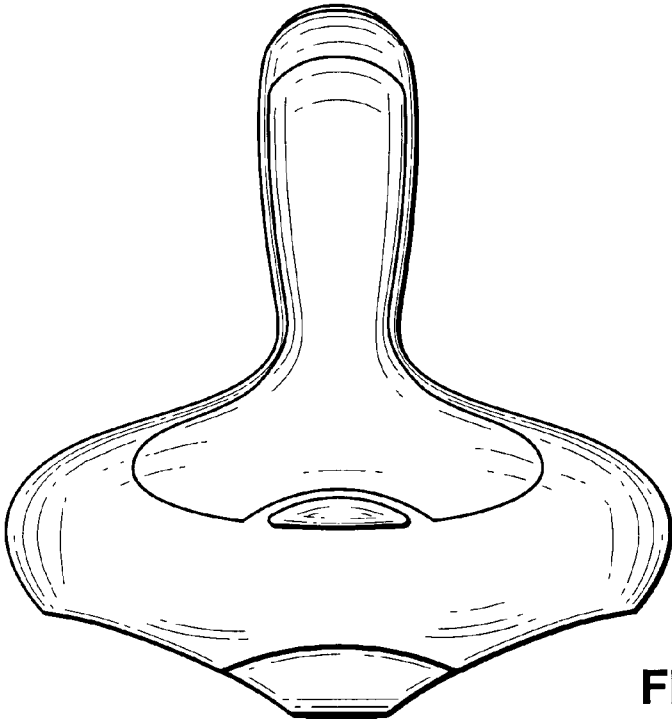

FIG. 5

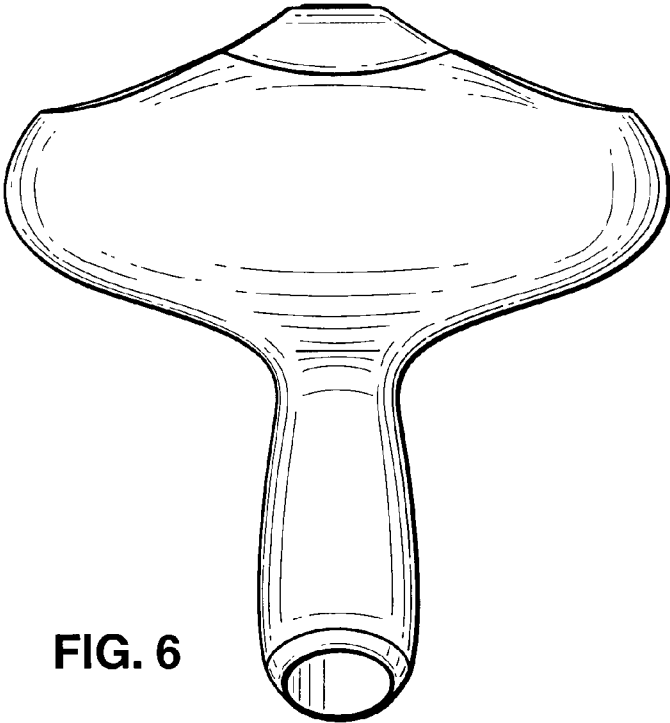

FIG. 6