

FIG. 1

*Sanchita*

Dr. SANCHITA GANGULI  
of S. MAJUMDAR & CO.  
(Applicant's Agent)

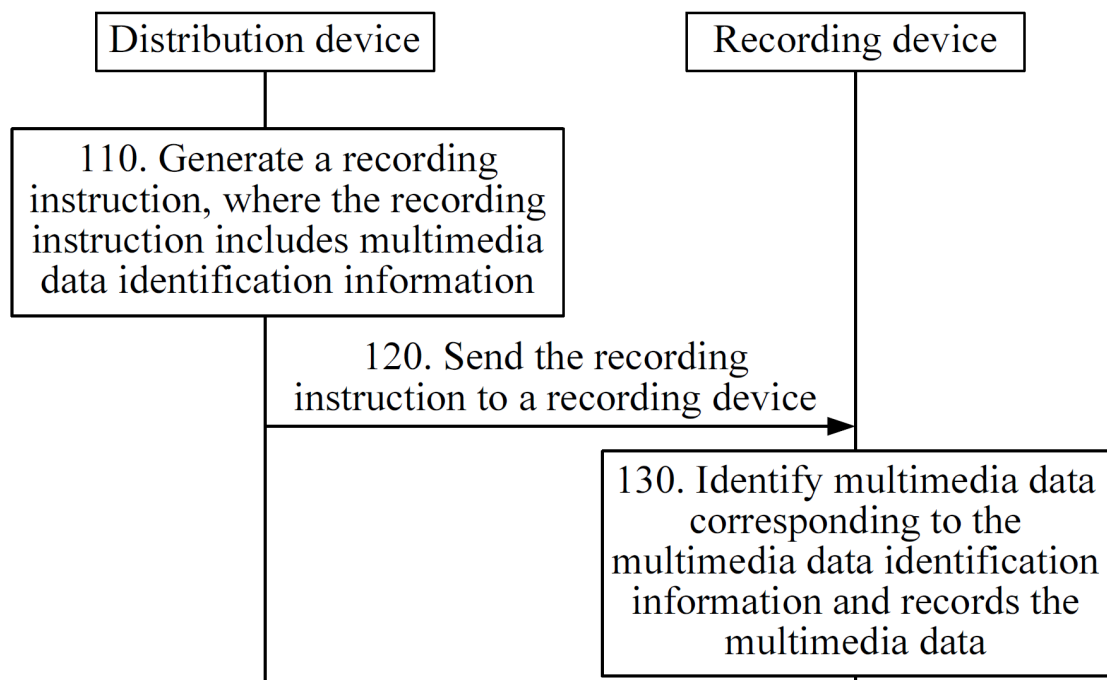

FIG. 2

*Sanchita*

Dr. SANCHITA GANGULI  
of S. MAJUMDAR & CO.  
(Applicant's Agent)

```

INVITE sip:8000@192.162.1.29:5067;user=phone SIP/2.0
Via: SIP/2.0/UDP 192.167.1.248:5060;branch=z9hG4bKrrzja94j57az0r52300m54mrx
Call-ID: a7o79zo5j090x5xx9x33yayy4yo0ly93@192.167.1.248
From: <sip:1086@192.167.1.248;user=phone>;tag=1523z0o9
To: <sip:8000@192.162.1.29:5067>
CSeq: 1 INVITE
Contact: <sip:1086@192.167.1.248:5060;user=phone>
Allow:
INVITE,ACK,OPTIONS,BYE,CANCEL,REGISTER,INFO,PRACTACK,SUBSCRIBE,NOTIFY,UPDATE,REFER,
PUBLISH
Max-Forwards: 70
Content-Length: 338
Content-Type: application/sdp

v=0
o=HuaweiUAPV100R002C06SPC100B017 155 155 IN IP4 192.167.1.248
s=Sip Call
c=IN IP4 192.167.1.248
t=0 0
m=audio 10574 RTP/AVP 8 0 18 4 97
a=rtpmap:8 PCMA/8000
a=rtpmap:0 PCMU/8000
a=rtpmap:18 G729/8000
a=rtpmap:4 G723/8000
a=rtpmap:97 telephone-event/8000
a=fmtp:97 0-15
a=fmtp:18 annexb=no
a=fmtp:4 annexa=no

```

FIG. 3-1



Dr. SANCHITA GANGULI  
of S. MAJUMDAR & CO.  
(Applicant's Agent)

```

SIP/2.0 200 OK
Via: SIP/2.0/UDP 192.167.1.248 :5060;branch=z9hG4bKrrzja94j57az0r52300m54mrx
From: <sip:1086@192.167.1.248;use r=phone>;tag=152 3z0o9
To: <sip:8000@192.162.1.2 9:5067>;tag=1570 184523
Call-ID: a7o79zo5j090x5xx9x33yayy4yo01y93@192.167.1.248..
CSeq: 1 INVITE..
Contact: <sip:8000@192.162.1.29:5067>
Content-Type: application/sdp
Allow: INVITE, INFO, PRACK, ACK, BYE, CANCEL, OPTIONS, NOTIFY, REGISTER, SUBSCRIBE,
REFER, PUBLISH, UPDATE, MESSAGE
User-Agent: Huawei eSpace 7850 2.60.94.19
Content-Length: 219

v=0
o=- 20042 20042 IN IP4 192.162.1.29
s=SDP data
c=IN IP4 192.162.1.29
t=0 0
m=audio 11798 RTP/AVP 18 97
a=rtpmap:18 G729/8000
a=fmtp:18 annexb=no
a=ptime:20
a=fmtp:97 0-15
a=rtpmap:97 telephone-event/8000

```

FIG. 3-2



Dr. SANCHITA GANGULI  
of S. MAJUMDAR & CO.  
(Applicant's Agent)

Source IP address	Destination IP address	Source port number	Destination port number	RTP packet	
192.167.1.248	192.162.1.29	10574	11798	RTP header field	Multimedia data

FIG. 4-1

*Sanchita*

Dr. SANCHITA GANGULI  
of S. MAJUMDAR & CO.  
(Applicant's Agent)

Source IP address	Destination IP address	Source port number	Destination port number	RTP packet	
192.162.1.29	192.167.1.248	11798	10574	RTP header field	Multimedia data

FIG. 4-2

*Sanchita*

Dr. SANCHITA GANGULI  
of S. MAJUMDAR & CO.  
(Applicant's Agent)

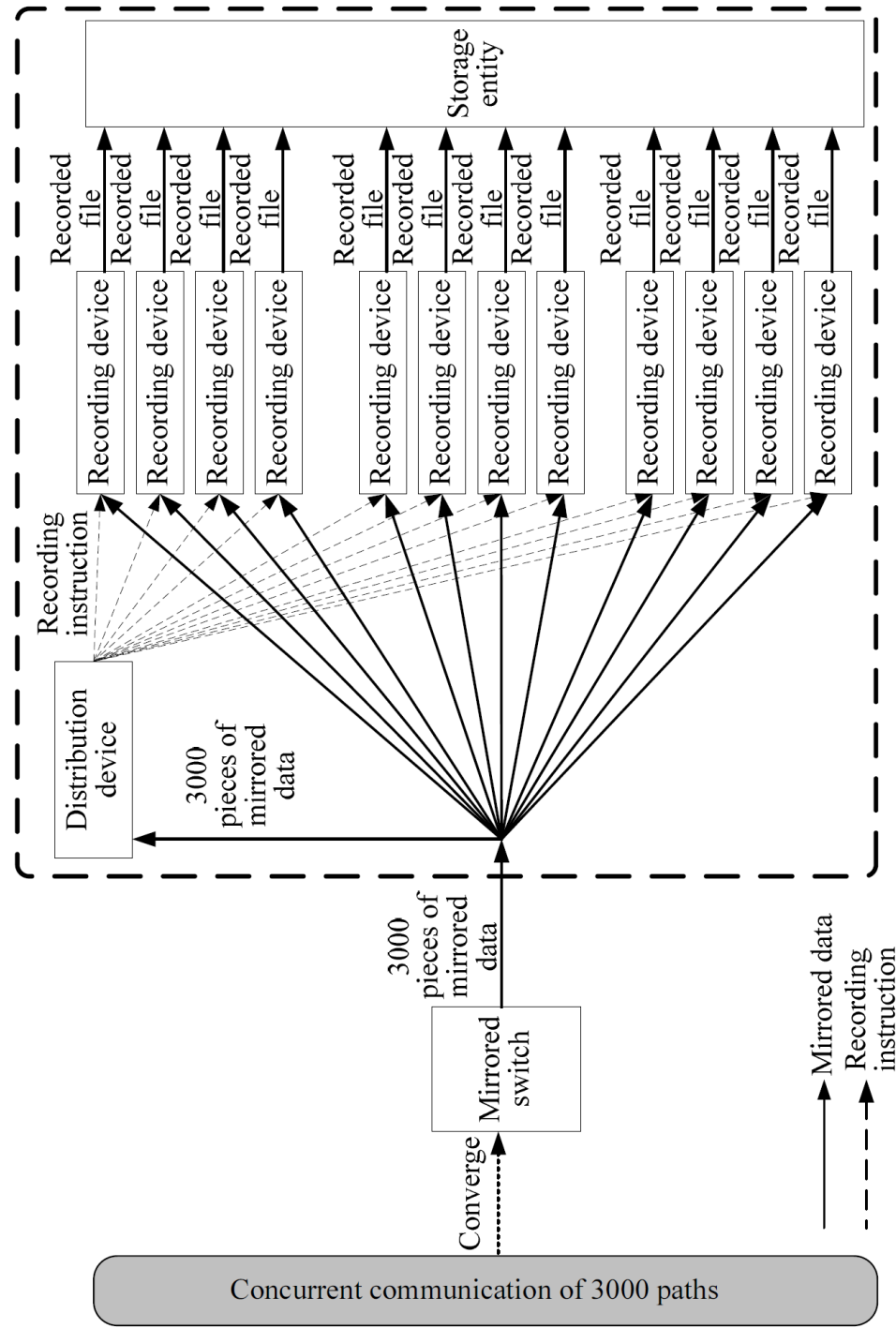

FIG. 5

*Sanchita*

Dr. SANCHITA GANGULI  
of S. MAJUMDAR & CO.  
(Applicant's Agent)

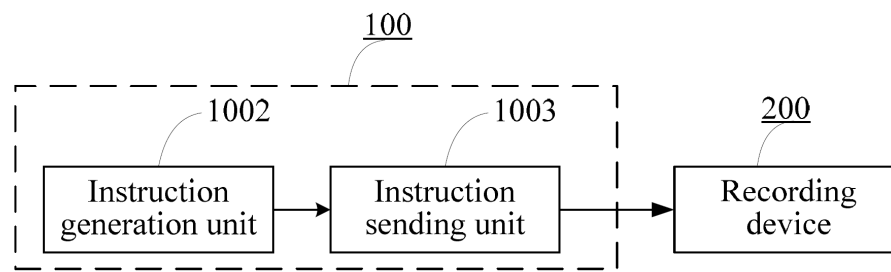

FIG. 6

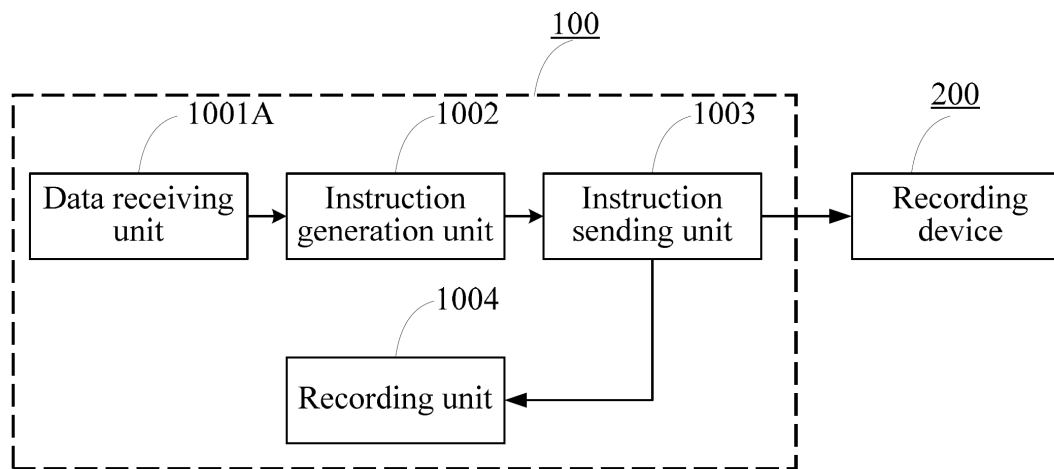

FIG. 7

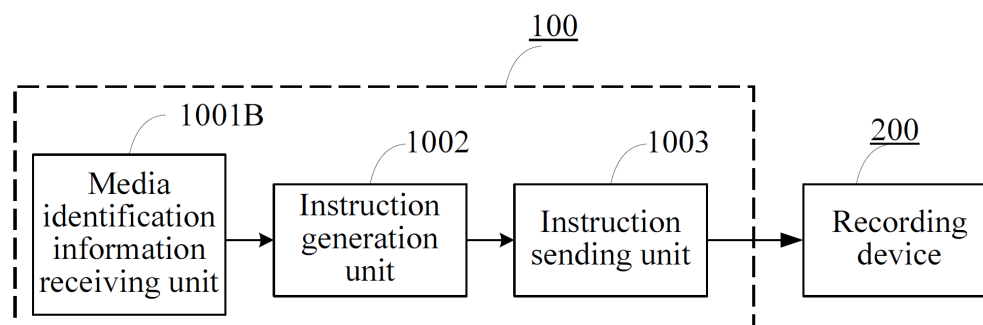

FIG. 8

*Sanchita*

Dr. SANCHITA GANGULI  
of S. MAJUMDAR & CO.  
(Applicant's Agent)

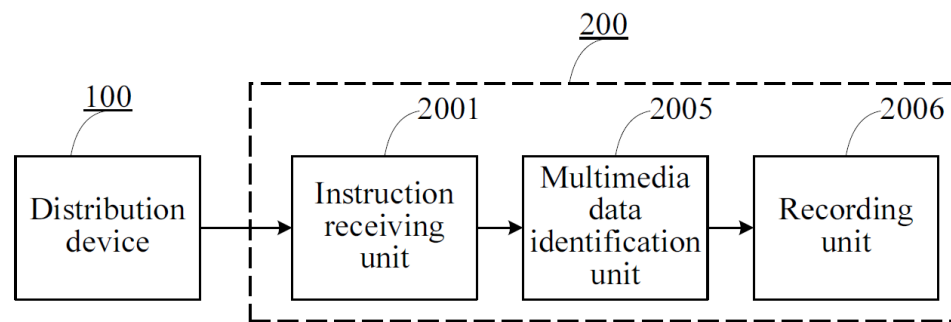

FIG. 9

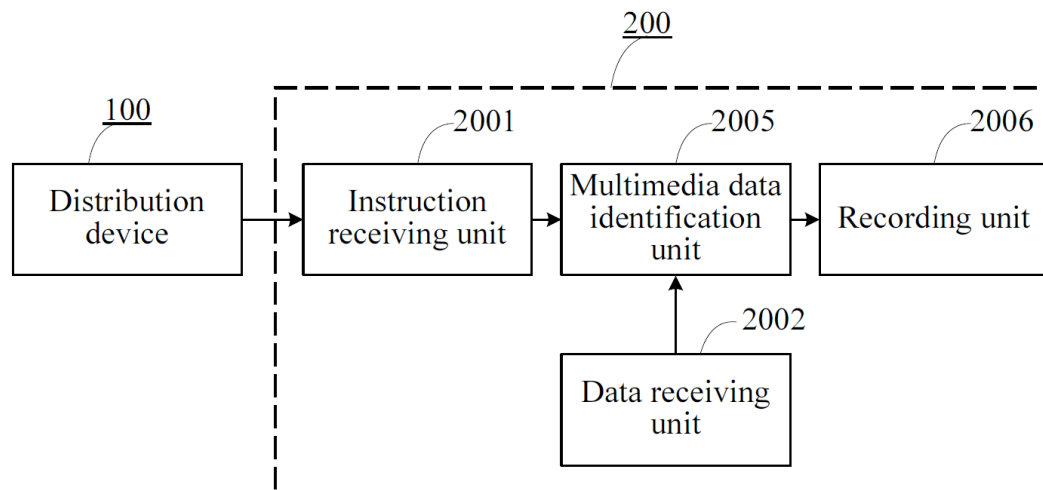

FIG. 10

*Sanchita*

Dr. SANCHITA GANGULI  
of S. MAJUMDAR & CO.  
(Applicant's Agent)

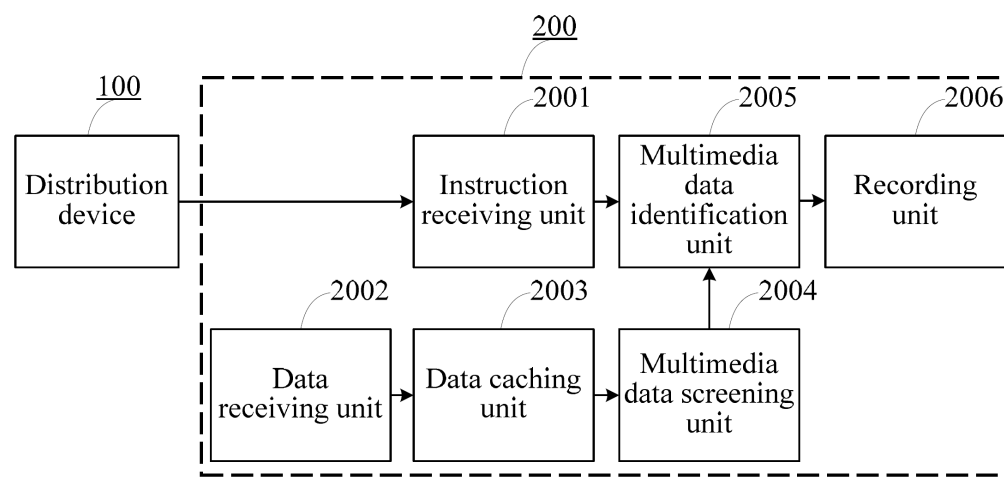

FIG. 11

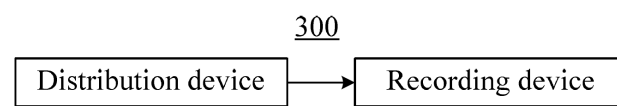

FIG. 12

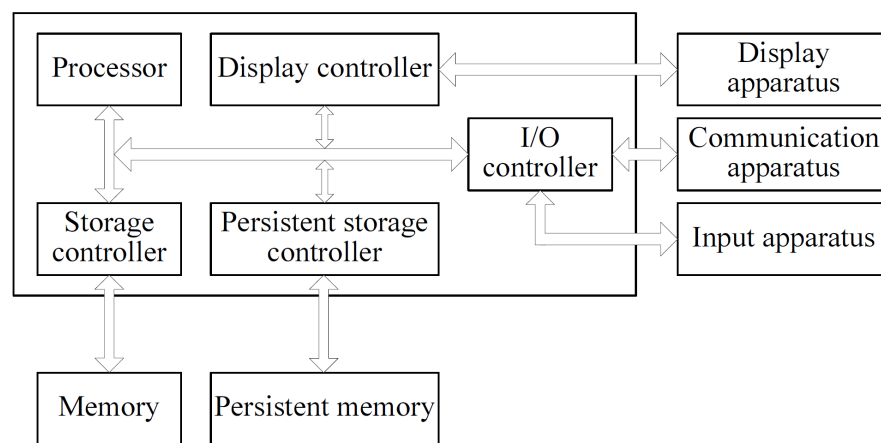

FIG. 13

*Sanchita*

Dr. SANCHITA GANGULI  
of S. MAJUMDAR & CO.  
(Applicant's Agent)