



US00D691268S

(12) **United States Design Patent**
Marsteller et al.

(10) **Patent No.:** **US D691,268 S**

(45) **Date of Patent:** **** *Oct. 8, 2013**

(54) **FIXED-SHAPE CANNULA FOR POSTERIOR DELIVERY OF RADIATION TO EYE**

(75) Inventors: **Laurence J. Marsteller**, Tucson, AZ (US); **Michael Voevodsky**, Tucson, AZ (US); **Luca Brigatti**, Rockville, MD (US); **Russell J. Hamilton**, Tucson, AZ (US)

(73) Assignee: **Salutaris Medical Devices, Inc.**, Tucson, AZ (US)

(*) Notice: This patent is subject to a terminal disclaimer.

(**) Term: **14 Years**

(21) Appl. No.: **29/391,558**

(22) Filed: **May 10, 2011**

Related U.S. Application Data

(63) Continuation-in-part of application No. 29/368,501, filed on Aug. 24, 2010, now abandoned, which is a continuation-in-part of application No. 29/368,499, filed on Aug. 24, 2010, now Pat. No. Des. 642,266, which is a continuation-in-part of application No. 12/917,044, filed on Nov. 1, 2010, which is a continuation-in-part of application No. 12/497,644, filed on Jul. 3, 2009, now abandoned, which is a continuation-in-part of application No. 12/350,079, filed on Jan. 7, 2009, now Pat. No. 8,430,804.

(51) **LOC (9) Cl.** **24-02**

(52) **U.S. Cl.**
USPC **D24/150**

(58) **Field of Classification Search**
USPC D24/107, 108, 112, 113, 127, 130, D24/133, 150, 144, 145, 147; 600/1-8; 606/161, 166; 604/20, 27, 93.01, 264; 623/6.12; D19/65

See application file for complete search history.

(56) **References Cited**

U.S. PATENT DOCUMENTS

2,309,302 A 1/1943 Butler et al.
2,559,793 A 7/1951 Pregel

(Continued)

FOREIGN PATENT DOCUMENTS

AU 323700 S 1/2009
AU 323701 S 1/2009

(Continued)

OTHER PUBLICATIONS

JC Wen et al; Ocular complications following I-125 brachytherapy for choroidal melanoma; Eye; 2009; 23; 1254-1268.

(Continued)

Primary Examiner — Ian Simmons

Assistant Examiner — Carissa C Fitts

(57) **CLAIM**

The ornamental design for a fixed-shape cannula for posterior delivery of radiation to an eye, as shown and described.

DESCRIPTION

FIG. 1 is a perspective view of a fixed-shape cannula for posterior delivery of radiation to an eye showing my new design;

FIG. 2 is a front view thereof;

FIG. 3 is a side view (opposite side view is mirror image) thereof;

FIG. 4 is a back view thereof;

FIG. 5 is top view thereof;

FIG. 6 is a bottom view thereof; and,

FIG. 7 is a side view in use thereof.

In FIGS. 1-7, the broken lines showing of environmental structure for purposes of illustrating the fixed-shape cannula for posterior delivery of radiation to an eye in a condition of use. The broken lines and the structure they depict form no part of the claimed design.

1 Claim, 3 Drawing Sheets

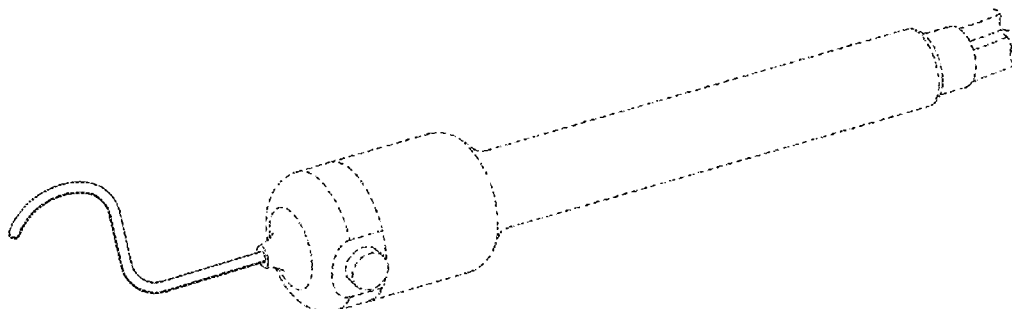

(56)

References Cited

U.S. PATENT DOCUMENTS

D183,820 S	10/1958	Yohe	7,153,316 B1	12/2006	McDonald
3,169,527 A	2/1965	Sheridan	D534,650 S	1/2007	Inman et al.
3,662,882 A	5/1972	Obermayer	D543,626 S	5/2007	Watschke et al.
D235,171 S	5/1975	Boone	7,217,263 B2	5/2007	Humayun et al.
D235,172 S	5/1975	Boone	7,220,225 B2	5/2007	Dejuan, Jr. et al.
D236,920 S	9/1975	Sheridan	7,223,225 B2	5/2007	DeJuan, Jr. et al.
4,248,354 A	2/1981	Metzger	7,228,181 B2	6/2007	Greenberg et al.
4,265,231 A *	5/1981	Scheller et al. 606/80	7,252,006 B2	8/2007	Tai et al.
4,300,557 A	11/1981	Refojo et al.	7,273,445 B2	9/2007	Pulido et al.
D272,089 S	1/1984	Glassman	D553,738 S	10/2007	Simpson
4,643,716 A *	2/1987	Drach 604/8	7,276,019 B2	10/2007	DeJuan, Jr. et al.
4,782,819 A *	11/1988	Adair 600/109	7,308,487 B1	12/2007	Dansie et al.
4,925,450 A	5/1990	Imonti et al.	7,321,796 B2	1/2008	Fink et al.
4,976,266 A	12/1990	Huffman et al.	7,351,193 B2	4/2008	Foreman et al.
5,007,689 A	4/1991	Kelly et al.	7,357,770 B1	4/2008	Cutrer et al.
5,109,844 A	5/1992	de Juan, Jr. et al.	7,402,155 B2	7/2008	Palasis et al.
5,127,831 A	7/1992	Bab	D575,396 S	8/2008	Wu
5,163,928 A *	11/1992	Hobbs et al. 604/532	7,422,557 B2 *	9/2008	Arnal et al. 600/30
5,167,647 A	12/1992	Wijkamp et al.	7,485,113 B2	2/2009	Varner et al.
5,199,939 A	4/1993	Dake et al.	7,503,474 B2	3/2009	Hillstead et al.
5,245,992 A *	9/1993	Nye 128/200.26	7,537,593 B2	5/2009	Humayun
D340,111 S	10/1993	Yoshikawa	7,547,323 B2	6/2009	Lavigne
D345,417 S	3/1994	Sharipov	7,560,460 B2	7/2009	Fotsch et al.
D347,473 S	5/1994	Nitzsche	7,563,222 B2	7/2009	Larsen et al.
5,308,349 A *	5/1994	Mikhail 606/88	7,571,004 B2	8/2009	Roy et al.
5,364,374 A	11/1994	Morrison et al.	7,575,566 B2 *	8/2009	Scheib 604/41
5,392,914 A	2/1995	Lemieux et al.	7,579,347 B2	8/2009	Bo et al.
5,399,298 A	3/1995	Kelly et al.	7,600,533 B2	10/2009	Tai et al.
5,637,073 A	6/1997	Freire	7,654,716 B1	2/2010	Bhadri et al.
5,709,692 A *	1/1998	Mollenauer et al. 606/141	7,661,676 B2	2/2010	Smith et al.
D390,656 S	2/1998	Linder	7,684,868 B2	3/2010	Tai et al.
5,743,853 A *	4/1998	Lauderdale 600/210	D615,645 S	5/2010	Brigatti et al.
5,810,882 A *	9/1998	Bolduc et al. 606/213	D616,087 S	5/2010	Brigatti et al.
5,871,481 A	2/1999	Kannenberg et al.	D616,088 S	5/2010	Brigatti et al.
5,893,873 A	4/1999	Rader et al.	D616,540 S	5/2010	Brigatti et al.
5,935,155 A	8/1999	Humayun et al.	7,729,739 B2	6/2010	Acar et al.
5,944,747 A	8/1999	Greenberg et al.	7,744,520 B2	6/2010	Larsen et al.
5,947,891 A	9/1999	Morrison	7,774,931 B2	8/2010	Tai et al.
5,970,457 A	10/1999	Brant et al.	7,794,437 B2	9/2010	Humayun et al.
6,053,900 A	4/2000	Brown et al.	7,803,102 B2	9/2010	Larsen et al.
D428,140 S	7/2000	Swan	7,803,103 B2	9/2010	Hillstead et al.
6,135,984 A	10/2000	Dishler	7,810,233 B2	10/2010	Krulevitch et al.
6,149,643 A	11/2000	Herekar et al.	7,819,868 B2 *	10/2010	Cao et al. 606/41
6,159,205 A	12/2000	Herekar et al.	7,827,038 B2	11/2010	Richard et al.
6,183,410 B1	2/2001	Jacobsen et al.	7,831,309 B1	11/2010	Humayun et al.
6,183,435 B1	2/2001	Bumbalough et al.	7,842,686 B2	11/2010	Anderson et al.
D442,687 S *	5/2001	Schulz D24/135	7,846,954 B2	12/2010	Zimmermann et al.
6,278,975 B1	8/2001	Brant et al.	7,879,564 B2	2/2011	Brice et al.
6,302,839 B1	10/2001	Chernomorsky et al.	7,883,717 B2	2/2011	Varner et al.
6,306,074 B1 *	10/2001	Waksman et al. 600/7	7,887,508 B2	2/2011	Meng et al.
6,402,734 B1	6/2002	Weiss	D642,266 S	7/2011	Marsteller et al.
6,413,245 B1	7/2002	Yaacobi et al.	D642,680 S *	8/2011	Brucker et al. D24/145
6,443,881 B1	9/2002	Finger	7,988,615 B2 *	8/2011	Anderson et al. 600/30
6,450,938 B1	9/2002	Miller	8,048,024 B2 *	11/2011	Tah et al. 604/95.04
6,527,692 B1	3/2003	Weinberger	8,062,358 B2 *	11/2011	Mathis et al. 623/2.37
6,575,887 B1	6/2003	Schrayer	8,066,693 B2 *	11/2011	Tanghoj et al. 604/544
6,613,026 B1	9/2003	Palasis et al.	D650,076 S *	12/2011	Dapri et al. D24/133
6,641,518 B2	11/2003	Wolfson et al.	2001/0008950 A1	7/2001	Vitali et al.
6,676,590 B1	1/2004	Urick et al.	2001/0049464 A1	12/2001	Ganz
6,719,750 B2	4/2004	Varner et al.	2002/0002362 A1	1/2002	Humayun et al.
6,749,553 B2	6/2004	Brauckman et al.	2002/0026174 A1	2/2002	Wallace
6,755,338 B2	6/2004	Hahnen et al.	2002/0062136 A1	5/2002	Hillstead et al.
D492,778 S	7/2004	Narini	2002/0065448 A1	5/2002	Bradshaw et al.
6,800,076 B2	10/2004	Humayun	2002/0077687 A1	6/2002	Ahn
6,824,532 B2	11/2004	Gillis et al.	2002/0099363 A1	7/2002	Woodward et al.
6,830,174 B2	12/2004	Hillstead et al.	2002/0115902 A1	8/2002	Dejuan, Jr. et al.
6,875,165 B2	4/2005	Dejuan, Jr. et al.	2002/0164061 A1	11/2002	Paik et al.
6,918,894 B2	7/2005	Fleury et al.	2002/0198511 A1	12/2002	Varner et al.
6,958,055 B2	10/2005	Donnan et al.	2003/0014306 A1	1/2003	Marko
6,964,653 B2	11/2005	Negron	2003/0045900 A1	3/2003	Hahnen et al.
6,977,264 B2	12/2005	Fotsch et al.	2003/0103945 A1	6/2003	Chen et al.
7,070,556 B2	7/2006	Anderson et al.	2003/0153804 A1	8/2003	Tornes et al.
7,103,416 B2	9/2006	Ok et al.	2003/0171722 A1	9/2003	Paques et al.
7,115,607 B2	10/2006	Fotsch et al.	2003/0184859 A1	10/2003	Liang et al.
7,141,048 B1 *	11/2006	Charles 606/4	2003/0195201 A1	10/2003	Bo et al.
			2003/0220324 A1	11/2003	Fotsch et al.
			2004/0006067 A1	1/2004	Fotsch et al.
			2004/0039312 A1	2/2004	Hillstead et al.
			2004/0053309 A1	3/2004	Holt et al.

2004/0133155 A1 7/2004 Varner et al.
 2004/0138515 A1 7/2004 White et al.
 2004/0224777 A1 11/2004 Smith et al.
 2004/0243176 A1 12/2004 Hahnen et al.
 2005/0059956 A1 3/2005 Varner et al.
 2005/0101824 A1 5/2005 Stubbs
 2005/0107824 A1 5/2005 Hillstead et al.
 2005/0148948 A1 7/2005 Caputa
 2005/0149286 A1 7/2005 Acar et al.
 2005/0177019 A1 8/2005 DeJuan, Jr. et al.
 2005/0203331 A1 9/2005 Szapucki et al.
 2005/0227986 A1 10/2005 Bo et al.
 2005/0272931 A1 12/2005 Bo et al.
 2005/0277802 A1 12/2005 Larsen et al.
 2006/0009493 A1 1/2006 Koenig et al.
 2006/0030618 A1 2/2006 Bo et al.
 2006/0052796 A1 3/2006 Perez et al.
 2006/0110428 A1 5/2006 deJuan et al.
 2006/0111605 A1 5/2006 Larsen et al.
 2006/0142629 A1 6/2006 DeJuan, Jr. et al.
 2006/0189838 A1 8/2006 DeJuan, Jr. et al.
 2006/0223026 A1 10/2006 Kuroiwa et al.
 2006/0235877 A1 10/2006 Richard et al.
 2006/0257451 A1 11/2006 Varner et al.
 2006/0287662 A1 12/2006 Berry et al.
 2007/0019790 A1 1/2007 Lewis et al.
 2007/0055089 A1 3/2007 Larsen et al.
 2007/0118010 A1 5/2007 Hillstead et al.
 2007/0179471 A1 8/2007 Christian et al.
 2007/0219546 A1 9/2007 Mody et al.
 2007/0233037 A1 10/2007 Gifford, III et al.
 2007/0248545 A1 10/2007 Brice et al.
 2007/0265248 A1 11/2007 Fotsch et al.
 2007/0265485 A1 11/2007 DeJuan, Jr. et al.
 2008/0027266 A1 1/2008 Lebovic et al.
 2008/0108933 A1 5/2008 Yu et al.
 2008/0154204 A1 6/2008 Varner et al.
 2008/0161762 A1 7/2008 Stehr et al.
 2008/0172086 A1 7/2008 Hillstead et al.
 2008/0200747 A1 8/2008 Wagner et al.
 2008/0214887 A1 9/2008 Heanue et al.
 2008/0221653 A1 9/2008 Agrawal et al.
 2008/0249412 A1 10/2008 Huang et al.
 2008/0262512 A1 10/2008 Humayun et al.
 2008/0262569 A1 10/2008 Greenberg et al.
 2008/0262570 A1 10/2008 Greenberg et al.
 2008/0262571 A1 10/2008 Greenberg et al.
 2008/0272023 A1 11/2008 McCormick et al.
 2008/0281142 A1 11/2008 Lubock et al.
 2008/0281254 A1 11/2008 Humayun et al.
 2008/0288036 A1 11/2008 Greenberg et al.
 2008/0294223 A1 11/2008 Greenberg et al.
 2008/0305320 A1 12/2008 Laude et al.
 2008/0306611 A1 12/2008 Rowley et al.
 2008/0319319 A1 12/2008 Humayun et al.
 2009/0016075 A1 1/2009 Bhadri et al.
 2009/0030323 A1 1/2009 Fawzi et al.
 2009/0036827 A1 2/2009 Cazzini
 2009/0069340 A1 3/2009 Balestra et al.
 2009/0088784 A1 4/2009 DeBoer et al.
 2009/0088843 A1 4/2009 Lu et al.
 2009/0101841 A1 4/2009 Boyden et al.
 2009/0104960 A1 4/2009 Kelly et al.
 2009/0104987 A1 4/2009 Kelly et al.
 2009/0112287 A1 4/2009 Greenberg et al.
 2009/0131175 A1 5/2009 Kelly et al.
 2009/0143124 A1 6/2009 Hughes et al.
 2009/0143633 A1 6/2009 Edmundson et al.
 2009/0143734 A1 6/2009 Humayun et al.
 2009/0146583 A1 6/2009 Bhadri et al.
 2009/0149915 A1 6/2009 Greenberg et al.
 2009/0177245 A1 7/2009 Ameri et al.
 2009/0192493 A1 7/2009 Meng et al.
 2009/0227856 A1 9/2009 Russell et al.
 2009/0228086 A1 9/2009 Greenberg et al.
 2009/0240215 A1 9/2009 Humayun et al.
 2009/0264424 A1 10/2009 Bo et al.
 2009/0287276 A1 11/2009 Greenberg et al.
 2009/0306585 A1 12/2009 Pang et al.

2009/0306594 A1 12/2009 Pang et al.
 2009/0306595 A1 12/2009 Shih et al.
 2009/0311133 A1 12/2009 Pang et al.
 2009/0312742 A1 12/2009 Pang et al.
 2010/0004499 A1 1/2010 Brigatti et al.
 2010/0004581 A1 1/2010 Brigatti et al.
 2010/0004639 A1 1/2010 Pang et al.
 2010/0025613 A1 2/2010 Tai et al.
 2010/0026957 A1 2/2010 Tanguay, Jr. et al.
 2010/0030010 A1 2/2010 Vermeere et al.
 2010/0076271 A1 3/2010 Humayun
 2010/0100104 A1 4/2010 Yu et al.
 2010/0105454 A1 4/2010 Weber et al.
 2010/0114039 A1 5/2010 Cazzini
 2010/0119696 A1 5/2010 Yu et al.
 2010/0121248 A1 5/2010 Yu et al.
 2010/0121249 A1 5/2010 Yu et al.
 2010/0131075 A1 5/2010 Ludlow et al.
 2010/0157620 A1 6/2010 Bhadri et al.
 2010/0168646 A1 7/2010 Greenbaum et al.
 2010/0174415 A1 7/2010 Humayun et al.
 2010/0197826 A1 8/2010 Agrawal et al.
 2010/0228119 A1 9/2010 Brennan et al.
 2010/0228123 A1 9/2010 Brennan et al.
 2010/0228124 A1 9/2010 Brennan et al.
 2010/0228132 A1 9/2010 Brennan et al.
 2010/0228238 A1 9/2010 Brennan et al.
 2010/0229384 A1 9/2010 Krulevitch et al.
 2010/0238288 A1 9/2010 Klaerner et al.
 2010/0267647 A1 10/2010 Greenbaum et al.
 2010/0268013 A1 10/2010 Larsen et al.
 2010/0294041 A1 11/2010 Tai et al.
 2010/0305550 A1 12/2010 Meng et al.
 2011/0004045 A1 1/2011 Larsen et al.
 2011/0021906 A1 1/2011 Hillstead et al.

FOREIGN PATENT DOCUMENTS

AU 323703 S 1/2009
 AU 323704 S 1/2009
 WO 2005016258 A2 2/2005
 WO 2007059208 A2 5/2007

OTHER PUBLICATIONS

Messmer E et al.; Histopathologic findings in eyes treated with a ruthenium plaque for uveal melanoma; Graefes Arch Clin Exp Ophthalmol.; 1992; 230 (4): 391-6.
 Raghava et al.; Periocular routes for retinal drug delivery; 2004, pp. 99-114, Ashley Publications.
 Venkatesh et al.; Comparison of the Efficacy and Safety of Different Methods of Posterior Subtenon Injection; Ocular Immunology and Inflammation; Oct. 1, 2007; pp. 217-223; Infoma Healthcare USA, Inc.
 Tenon's Capsule; Fundamentals and Principles; p. 39.
 Canavan et al.; Sub-Tenon's administration of local anaesthetic: a review of the technique; 2003; pp. 787-793; British Journal of Anaesthesia.
 Dafflon et al.; Posterior sub-Tenon's steroid injections for the treatment of posterior ocular inflammation: indications, efficacy and side effects, Graefe's Arch Clin Exp Ophthalmol., 1999, pp. 289-295; Springer-Verlag 1999.
 Tanner et al.; Posterior sub-Tenon's triamcinolone injections in the treatment of uveitis; Royal College of Ophthalmologists; 1998; pp. 679-685.
 Thach, MD et al.; A Comparison of Retrobulbar versus Sub-Tenon's Corticosteroid Therapy for Cystoid Macular Edema Refractory to Topical Medications; pp. 2003-2008; Ophthalmology Volue 104, No. 12, Dec. 1997.
 Hubbard et al.; A New Ocular Brachytherapy System for the Treatment of Exudative AMD; 2005; Invest Ophthalmol Vis Sci 2005; 46; E-Abstract 2425.
 Hubbard, III et al.; A Progress Report on the TheraSight Ocular Brachytherapy Safety and Feasibility Study; 2006; Invest Ophthalmol Vis Sci 2006; 47: E-Abstract 2101.
 The Collaborative Ocular Melanoma Study Group; Design and Methods of a Clinical Trial for a Rare Condition: The Collaborative

- Ocular Melanoma Study; COMS Report No. 3; 1993; Controlled Clinical Trials 14: 362-391; Elsevier Science Publishing Co., Inc. COMS Coordinating Center; Collaborative Ocular Melanoma Study; Manual of Procedures; Jan. 1995; pp. 1-330; The Wilmer Ophthalmological Institute; The Johns Hopkins School of Medicine (*reduced to cover and Table of Contents due to excessive data [330 pages]).
- Hubbard et al.; Cadaver Evaluation of a New Ocular Brachytherapy System; Invest Ophthalmol Vis Sci 2004; 45: E-Abstract 5139.
- Golden; SubTenon Injection of Gentamicin for Bacterial Infections of the Eye; pp. S271-S277; The Journal of Infectious Diseases; vol. 124, Supplement; Dec. 1971; University of Chicago.
- Snyder, MD, PhD et al.; Antibiotic Therapy for Ocular Infection; Conferences and Reviews; pp. 579-584; WJM, Dec. 1994; vol. 161, No. 6; Therapy for Ocular Infection—Snyder and Glasser.
- Baum, M.D. et al.; The Evolution of Antibiotic Therapy for Bacterial Conjunctivitis and Keratitis: 1970-2000; pp. 659-672; Cornea, vol. 19, No. 5, 2000; Lippincott Williams & Wilkins, Inc., Philadelphia.
- Scoper; Review of Third- and Fourth-Generation Fluoroquinolones in Ophthalmology: In-Vitro and In-Vivo Efficacy; Adv Ther. 2008; 25(10): 979-994; Springer Healthcare Communications.
- Yilmaz, MD et al.; Severe Fungal Keratitis Treated With Subconjunctival Fluconazole; 2003; pp. 454.e1-454.e7; vol. 140, No. 3; Elsevier Inc.
- Yilmaz, MD et al.; Severe Fungal Keratitis Treated With Subconjunctival Fluconazole; Apr. 2006; pp. 783-784; vol. 141, No. 4, Correspondence; American Journal of Ophthalmology.
- Ikewaki et al.; Peribulbar fungal abscess and endophthalmitis following posterior subtenon injection of triamcinolone acetonide; Diagnostics/Therapy in Ophthalmology; 2008; pp. 102-104; Acta Ophthalmologica; The Authors, Journal compilation, Acta Ophthalmol.
- Nayak et al.; Acute orbital abscess complicating deep posterior subtenon triamcinolone injection; Indian Journal of Ophthalmology; vol. 56, No. 3; May-Jun. 2008; downloaded from <http://www.ijo.in> on Monday, Nov. 2, 2009.
- Kusaka et al.; Orbital infection following posterior subtenon triamcinolone injection; 2207; pp. 692-693; Acta Ophthalmologica Scandinavica.
- Walker et al.; Conservative management of refractory steroid-induced glaucoma following anterior subtenon steroid injection; 2007; Letters to the Editor; pp. 197-198; The Authors, Journal compilation, Royal Australian and New Zealand College of Ophthalmologists.
- Au et al.; Localised abscess following an injection of subtenon triamcinolone acetonide; Correspondence; Eye (2007) 21, 627-674, doi:10.1038/sj.eye.6702671; published online Dec. 15, 2006.
- Venkatesh MD, et al.; Posterior subtenon injection of corticosteroids using polytetrafluoroethylene (PEFE) intravenous cannula; Clinical and Experimental Ophthalmology (2002) 30, 55-57; All India Institute of Medical Sciences Campus, India.
- Sou-Tung Chiu-Tsao, PH.D., Episcleral Eye Plaques for Treatment of Intraocular Malignancies and Benign Diseases; Chapter 34; pp. 673-705.
- Sou-Tung Chiu-Tsao, PH.D., Pterygium Brachytherapy Physics; Chapter 35; pp. 707-717.
- Nath, Ravinder, Ph.D. et al.; Brachytherapy Physics Second Edition; Medical Physics Monograph No. 31; 1013 pages; Medical Physics Publishing; Madison, Wisconsin, USA; 2005.
- Jaakkola, Aino; Heikkonen, Jorma; Tarkkanen, Ahti and Immonen, Ilkka; Visual function after strontium-90 plaque irradiation in patients with age-related subfoveal choroidal neovascularization; Acta Ophthalmologica Scandinavica 1999; 77; pp. 57-61.
- Hokkanen, J.; Heikkonen, J.; Holmberg, P.; Theoretical calculations of dose distributions for beta-ray eye applicators; Med. Phys. 24 (2); Feb. 1997pp. 211-213.
- Jaakkola, Aino; Heikkonen, Jorma; Tommila, Petri; Laatikainen, Leila; Immonen, Ilkka; Strontium plaque irradiation of subfoveal neovascular membranes in age-related macular degeneration; Graefes Arch Clin Exp Ophthalmol (1998); 236; pp. 24-30.
- J. M. Capping; Radiation scleral necrosis simulating early scleromalacia perforans; Brit. J. Ophthalmol.; 1973; 57; pp. 425-428.

* cited by examiner

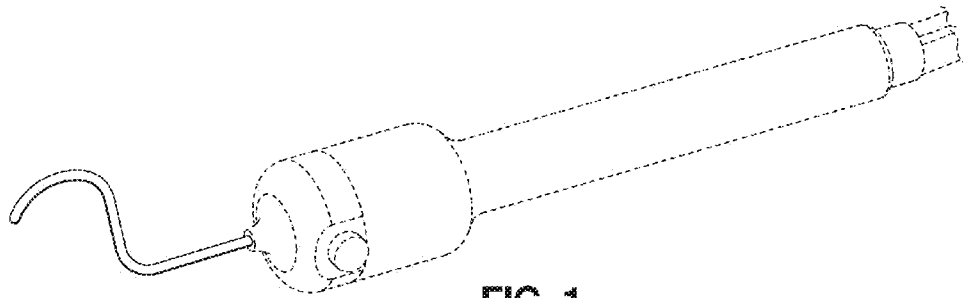

FIG. 1

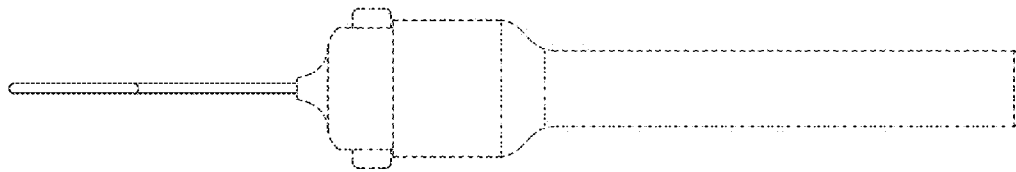

FIG. 2

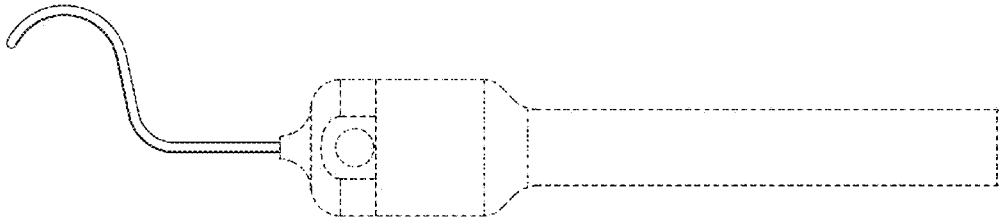

FIG. 3

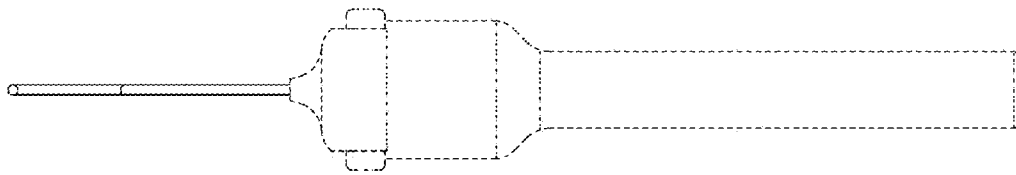

FIG. 4

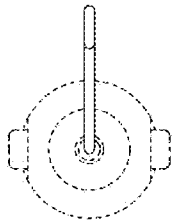

FIG. 5

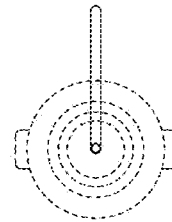

FIG. 6

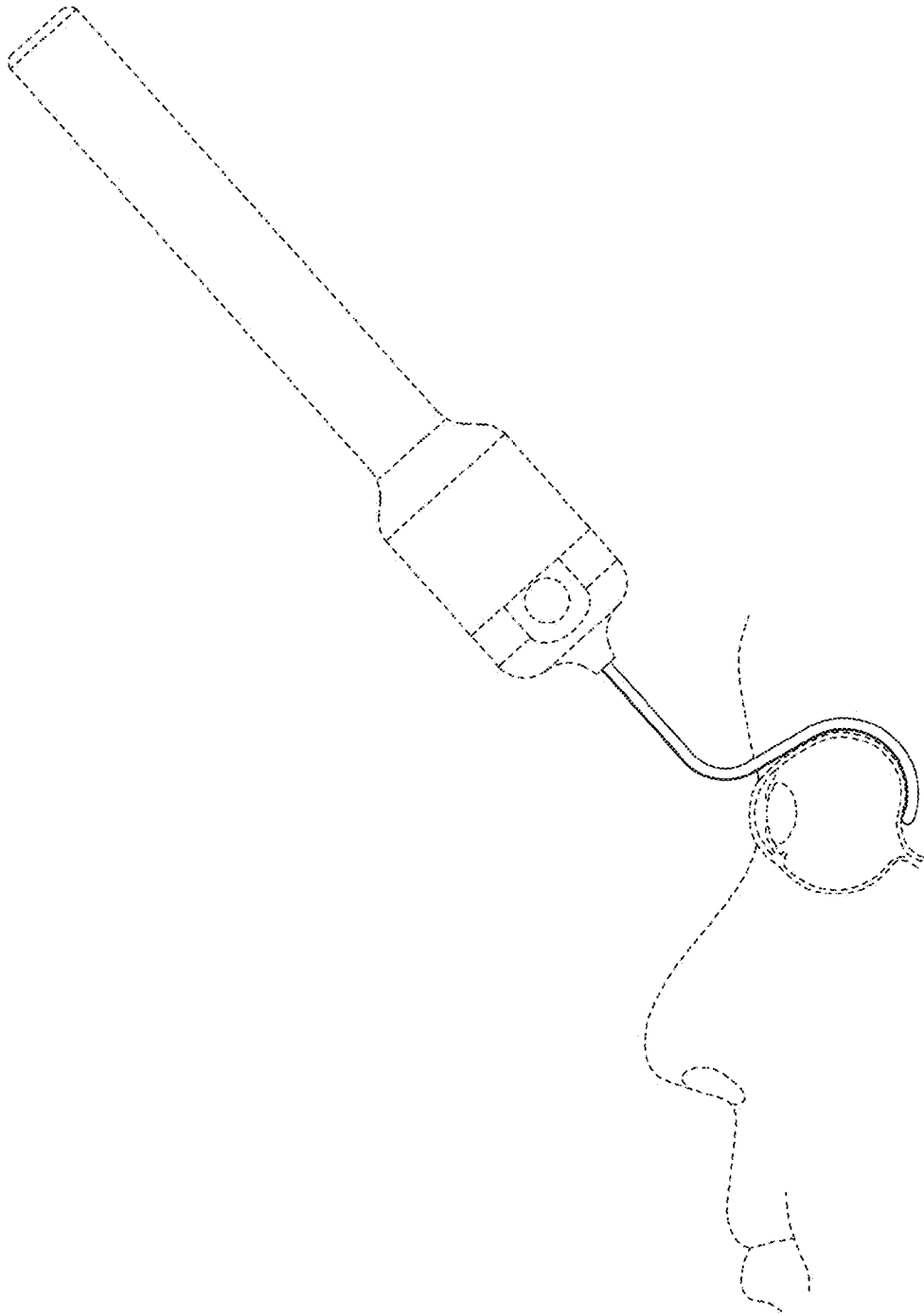

FIG. 7