



(86) Date de dépôt PCT/PCT Filing Date: 1993/12/02
 (87) Date publication PCT/PCT Publication Date: 1994/06/23
 (45) Date de délivrance/Issue Date: 2004/02/24
 (85) Entrée phase nationale/National Entry: 1995/06/09
 (86) N° demande PCT/PCT Application No.: US 1993/011617
 (87) N° publication PCT/PCT Publication No.: 1994/014281
 (30) Priorité/Priority: 1992/12/09 (07/991,074) US

(51) Cl.Int.⁶/Int.Cl.⁶ H04N 7/16
 (72) Inventeurs/Inventors:
 HENDRICKS, JOHN S., US;
 BONNER, ALFRED E., US
 (73) Propriétaire/Owner:
 DISCOVERY COMMUNICATIONS, INC., US
 (74) Agent: RICHES, MCKENZIE & HERBERT LLP

(54) Titre : CENTRE DE CONTROLE DES OPERATIONS POUR SYSTEME DE GROUPAGE ET DE DISTRIBUTION DE PROGRAMMES DE TELEVISION

(54) Title: AN OPERATION CENTER FOR A TELEVISION PROGRAM PACKAGING AND DELIVERY SYSTEM

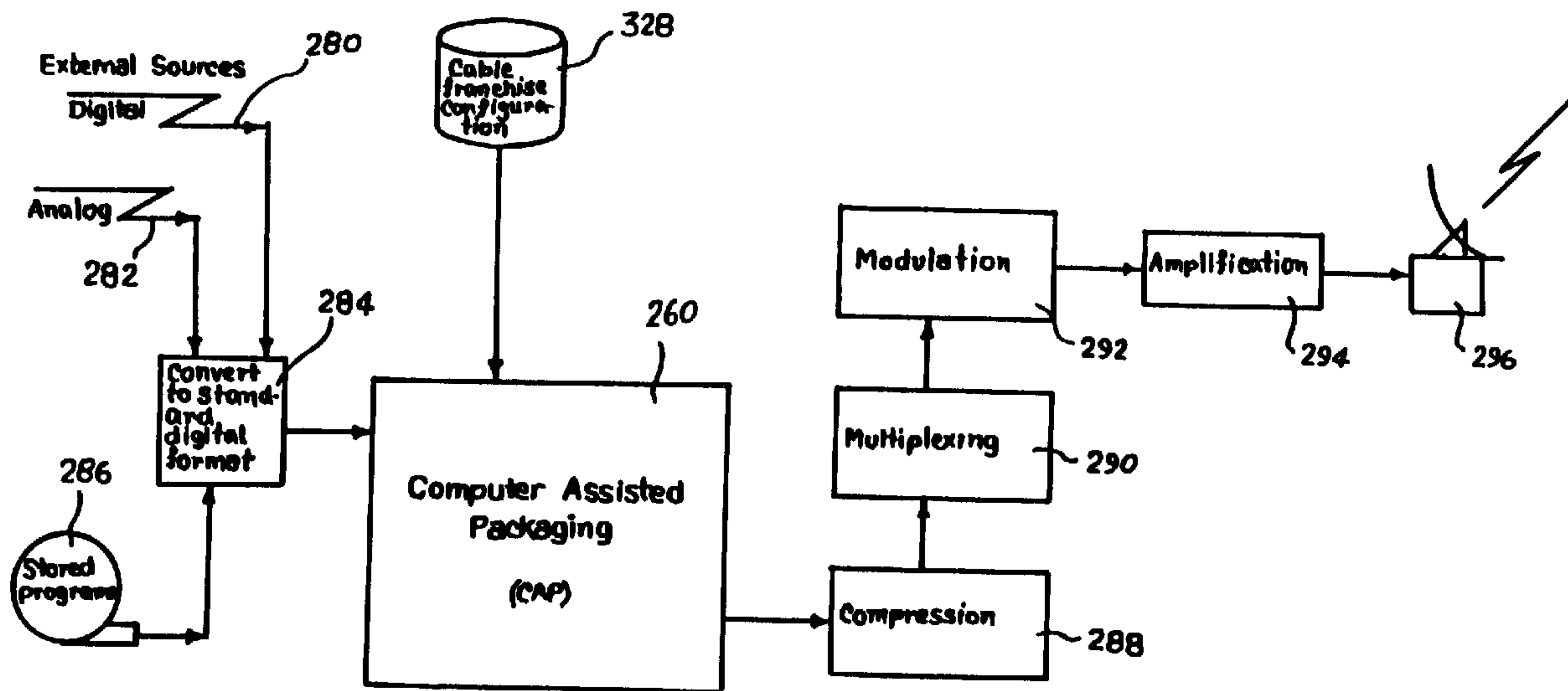

(57) Abrégé/Abstract:

An Operations Center (202) for television entertainment systems that provide television programming to consumer homes is disclosed. The Operations Center (202) organizes and packages television programming and program information for delivery to and from consumer homes. The Operations Center (202) includes a computerized packaging system (260) for creating a program control information signal.



INTERNATIONAL APPLICATION PUBLISHED UNDER THE PATENT COOPERATION TREATY (PCT)

(51) International Patent Classification ⁵ : H04N 7/16, 7/173	A1	(11) International Publication Number: WO 94/14281
		(43) International Publication Date: 23 June 1994 (23.06.94)

<p>(21) International Application Number: PCT/US93/11617</p> <p>(22) International Filing Date: 2 December 1993 (02.12.93)</p> <p>(30) Priority Data: 07/991,074 9 December 1992 (09.12.92) US</p> <p>(71) Applicant: DISCOVERY COMMUNICATIONS, INC. [US/US]; 7700 Wisconsin Avenue, Bethesda, MD 20814-3522 (US).</p> <p>(72) Inventors: HENDRICKS, John, S.; 8723 Persimmon Tree Road, Potomac, MD 20854 (US). BONNER, Alfred, E.; 8300 Bradley Boulevard, Bethesda, MD 20817 (US).</p> <p>(74) Agents: NOTO, Aldo; Dorsey & Whitney, 1330 Connecticut Avenue, N.W., Suite 200, Washington, DC 20036 (US) et al.</p>	<p>(81) Designated States: AT, AU, BE, BG, BR, BY, CA, CH, CZ, DE, DK, ES, FI, GB, HU, JP, KP, KR, KZ, LK, LU, LV, MG, MN, MW, NL, NO, NZ, PL, PT, RO, RU, SD, SE, SK, UA, VN, European patent (AT, BE, CH, DE, DK, ES, FR, GB, GR, IE, IT, LU, MC, NL, PT, SE), OAPI patent (BF, BJ, CF, CG, CI, CM, GA, GN, ML, MR, NE, SN, TD, TG).</p> <p>Published With international search report.</p> <p style="font-size: 2em; margin-left: 200px;">2151458</p>
--	---

(54) Title: AN OPERATION CENTER FOR A TELEVISION PROGRAM PACKAGING AND DELIVERY SYSTEM

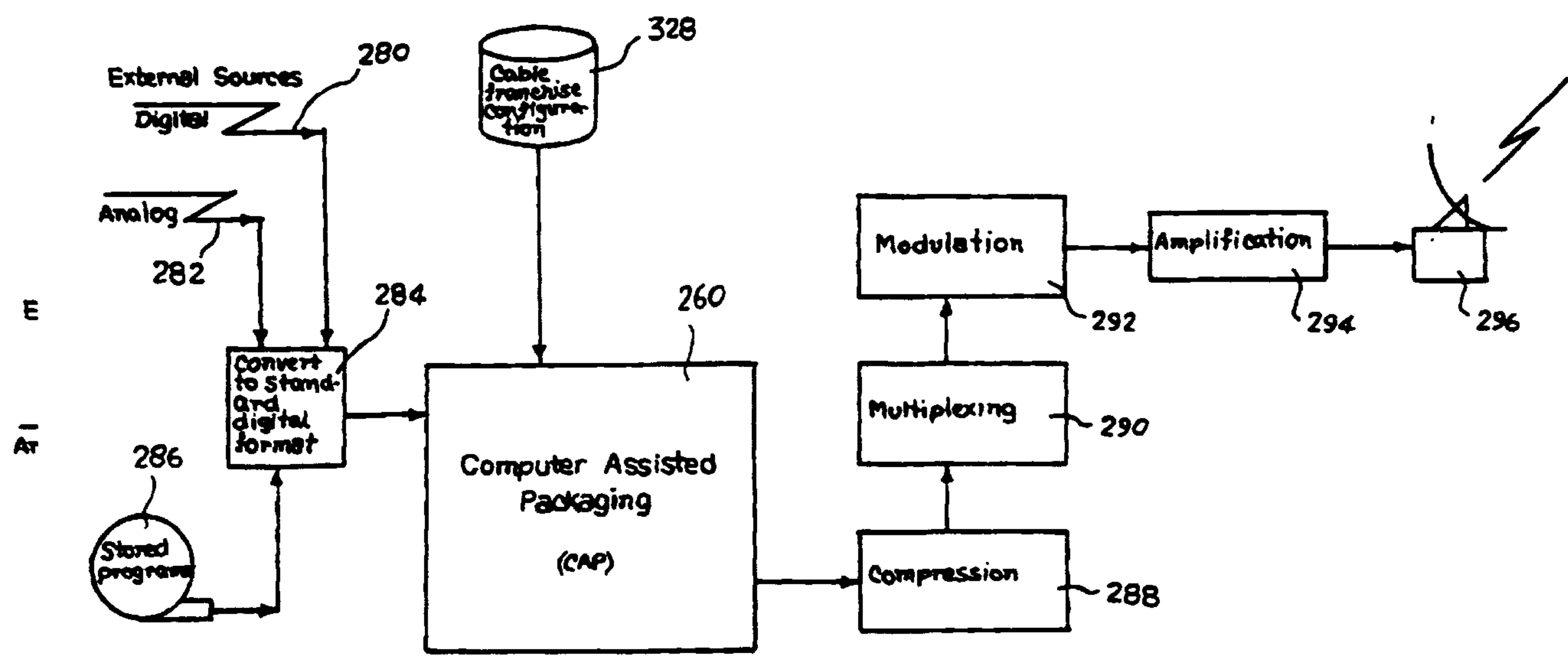

(57) Abstract

An Operations Center (202) for television entertainment systems that provide television programming to consumer homes is disclosed. The Operations Center (202) organizes and packages television programming and program information for delivery to and from consumer homes. The Operations Center (202) includes a computerized packaging system (260) for creating a program control information signal.

AN OPERATIONS CENTER
FOR A TELEVISION PROGRAM PACKAGING AND DELIVERY
SYSTEM

TECHNICAL FIELD

5

The invention relates to television entertainment delivery systems that provide television programming to consumer homes. More particularly, the invention relates to an Operations Center that organizes and packages cable television programming for delivery to consumer homes.

10

2151458

BACKGROUND OF THE INVENTION

Advances in television entertainment have been primarily driven by breakthroughs in technology. In 1939, advances on Vladimir Zworykin's picture tube provided the stimulus for NBC to begin its first regular broadcasts. In 1975, advances in satellite technology provided consumers with increased programming to homes.

Many of these technology breakthroughs have produced inconvenient systems for consumers. One example is the ubiquitous three remote control home, having a separate and unique remote control for the TV, cable box and VCR. More recently, technology has provided cable users with 100 channels of programming. This increased program capacity is beyond the ability of many consumers to use effectively. No method of managing the program choices has been provided to consumers.

Consumers are demanding that future advances in television entertainment, particularly programs and program choices, be presented to the consumer in a user friendly manner. Consumer preferences, instead of technological breakthroughs, will drive the television entertainment market for at least the next 20 years. As computer vendors have experienced a switch from marketing new technology in computer hardware to marketing better useability, interfaces and service, the television entertainment industry will also experience a switch from new technology driving the market to consumer useability driving the market.

In order for new television entertainment products to be successful, the products must satisfy consumer demands. TV consumers wish to go from limited viewing choices to a variety of choices, from no control of programming to complete control. Consumers do not wish to pay for one

hundred channels when due to lack of programming information, they seldom, if ever, watch programming on many of these channels.

5 The concepts of interactive television, high definition television and 300-500 channel cable systems in consumer homes will not sell if they are not packaged, delivered and presented in a useable fashion to consumers. The problem is that TV programming is not being managed, packaged, delivered, and presented to consumers in a user friendly
10 manner.

 Consumers are already being bombarded with programming options, numerous "free" cable channels, subscription cable channels and pay-per-view choices. Any further increase in TV entertainment choices will likely
15 bewilder viewers with a mind-numbing array of choices.

 The TV industry has traditionally marketed and sold its programs to consumers in bulk, such as continuous feed broadcast and long-term subscriptions to movie channels. The TV industry is unable to sell its programming in large
20 quantities on a per unit basis, such as the ordering of one program.

 In today's television world networks manage the program lineup for individual channels. Each network analyzes ratings for television shows and determines the
25 appropriate schedule or program lineup to gain market share and revenue from advertising. Since each channel is in competition with every other channel, there is no coordinated effort to organize television programming in a manner that primarily suits the viewers.

30 Additionally, viewership fragmentation, which has already begun to decrease a channel's or program's market share, will increase. Programming not presented in a user

2151458

friendly manner will suffer with a decrease in viewership and revenue.

5 And finally, with the imminent introduction of digital television technology, current television delivery systems do not have the capabilities or features necessary to operate in the digital environment.

What is needed is a method of organizing programming to be offered to viewers.

10 What is needed is a television program delivery system that can be operated in a distributive fashion and controlled from one or more national centers.

15 What is needed is an Operations Center for a system which can gather television programming in a variety of formats, package the programs, deliver the programs, and present the programs through a user friendly interface which allows the consumer to easily select from among the many program choices.

What is needed is an Operations Center that is capable of handling hundreds of programs in different formats.

20 What is needed is an Operations Center that is expandable for future types of programming.

What is needed is needed is an Operations Center that can control certain features and software of a television delivery system.

25 What is needed is an Operations Center that operates in the digital audio/video environment.

What is needed is an Operations Center that formulates program menus for viewer use.

30 What is needed is a computer assisted program packaging system.

What is needed is an Operations Center that includes a method for billing consumers.

5

What is needed is an Operations Center that analyzes data on programs watched by viewers

The present invention is addressed to fulfillment of these needs.

5

SUMMARY OF INVENTION

This invention is a center for controlling the operations of a digital television program delivery system. Specifically, the present invention is an Operations Center that allows for the organizing and packaging of television programs for transmission in a television delivery system.

10

The Operations Center is the nerve center of the television program delivery system. It receives data on viewership behavior and utilizes the data to assist in packaging programs for future viewing. The Operations Center is a particularly useful invention for television delivery systems which will provide users with the ability to select programs from on-screen menus.

15

The Operations Center's primary component is a computer assisted packaging system (CAP), which makes use of the necessary hardware and software to control and transmit programming signals over a television delivery system. This computer assisted packaging system creates the program lineup or packaging of programs and the packaging of menu and control information for later transmission and use in the cable television systems. The CAP can be specially designed to generate graphical menu displays for user selection of programs. The hardware and software for controlling and transmitting programming signals over the television delivery system is particularly useful in large television delivery systems which include satellite transmissions to cable headends.

20

25

30

2151458

6

The software of the CAP performs the functions of gathering analog (and/or digital) program signals from a variety of sources such as broadcast television, premium channels, and video disk. The software also packages the programs efficiently for the available bandwidth and for subscriber viewing through computer assisted creation of program line-up and allocating of bandwidth. The line-ups are created to effectively group programming for display in menus by categories. The television programs are packaged with the program control information (such as cost for viewing certain program) and menu information.

The Operations Center of the present invention provides a method for remote management and control of local cable and CATV programs available and on-screen menu displays shown to subscribers. The Operations Center's computer software programs and hardware provide "real-time" control over cable and CATV systems. By transmitting appropriate control information the Operations Center has the ability to change allocation of programs across physical channels, update menu information (from the Operations Center location), reprogram menu formats and menu flow, and change or augment a packaged program signal sent to a particular region of the country. The Operations Center is able to control remotely certain features and software of the set top terminals and if necessary reprogram menu display software stored at the set top terminals.

In order to properly manage program lineups, the Operations Center acquires viewer information on programs watched. Such viewer information includes information about the buy rates of specific shows, viewer preferences for programming, and the like, gathered by recording viewer transactions. A compilation of viewer information data is

needed in order to make decisions on future individualized program lineup and program packaging. In addition, allocation of menu space and construction of menus is aided by the use of viewer information data. This information is received from the set top terminals using a feedback loop, usually through the cable headends.

The present invention is not only able to operate in the digital environment but introduces many new features to television program delivery.

In one aspect, the present invention provides a method for providing programming in a television delivery system, comprising: packaging the programming at a program delivery center, wherein the programming package includes at least one program; generating menu information related to the programming package; providing the menu information to terminals using the television delivery system; storing the menu information in the terminals; and displaying the menu information as programming menus, wherein a programming menu is displayed on a first portion of a display coupled to a terminal and wherein the programming menu is displayed using a television channel.

In a further aspect, the present invention provides a system that provides programming selection from a menu, comprising: a television delivery system that packages programming, wherein the programming package includes at least one program, generates menu information related to the

7a

programming, and provides the programming package and the menu information to subscribers; a terminal operably connected to the television delivery system, the terminal comprising: a memory that stores the menu information; a processor connected to the
5 memory that processes the menu information to generate the menu, and a control operably connected to the processor that provides program selection instructions to the processor; and a display operably connected to the terminal that displays the menu and the programming, wherein the terminal switches to a channel
10 carrying a program selected from the menu in response to a program selection instruction, the program selection instruction being a single control function.

In a further aspect, the present invention provides an operations center for use by a program packager to provide a
15 television program delivery system, said operations center comprising: a reception port for receiving television programs; external collection means for gathering television programs from external sources and feeding television programs from external sources to said reception port; internal collection means, connected
20 to said reception port, for gathering television programs from internal sources and feeding said television programs from internal sources to said reception port; a converter for converting any of said television programs that are in non-digital format to digital format; packaging means for creating program control
25 information and for packaging said digital format television programs using said program control information, said packaging means comprising: a central processing unit; an interface, connected to the central processing unit, to enable a program packager to enter program line-up information, wherein said

7b

interface is operably connected to said central processing unit; storage means, connected to the central processing unit, for storing said entered program line-up information; logic means, connected to the central processing unit, for arranging said stored program
5 **line-up information and for creating the program control information; and means, connected to the logic means, for generating a digital program control information signal from the program control information; combining means for creating a combined signal, said combined signal comprising the packaged**
10 **digital format programs and the digital program control information signal; and transmission means, operably connected to said packaging means, for transmitting said combined signal.**

In a still further aspect, the present invention provides a method of generating a digital program control data information
15 **signal for transmission to viewers receiving a simultaneously transmitted plurality of television programs so that variable video displays of current and future programming can be generated and so that the downstream displays of the television programs can be selected and controlled by the viewers, the method uses stored**
20 **marketing data, algorithms, and menus, the method comprising: receiving input data, including program names, start times, program duration or program category and price; combining the input data with the stored marketing data comprising the frequency with which programs are watched by viewers and the**
25 **demographics of viewers; weighing the combined data according to algorithms which assign a weight of importance to each type of data; generating from the weighted data a program line-up and program positions on menu formats resulting in a draft menu; displaying the resulting draft menu for editing; editing the draft**

7c

menu; and processing the edited menu to generate the digital program control data information signal for transmission to viewers.

In a further aspect, the present invention provides a
5 centralized operating center for packaging a large number of
diverse television programs for selective remote display by viewers
using information about television programs, the operating center
comprising: a receiver, wherein television programs are received in
analog or digital format, each having video and audio components;
10 a keyboard, wherein input commands are entered; a memory,
wherein the information about the television programs is stored; a
processor, operably connected to the memory and keyboard,
wherein a program control information signal is generated using
information stored in the memory and commands entered on the
15 keyboard, the program control information signal containing
specific identification concerning each television program in a
subset of television programs received by the receiver, including
the date and time of display comprising: a combiner, operably
connected to the processor and receiver, wherein the subset of
20 television programs identified in the program control information
signal are combined in preparation for transmission; a
multiplexer, connected to the combiner, wherein the combined
television programs and the program control information signal
are multiplexed for transmission; and a transmitter, connected to
25 the multiplexer, wherein the multiplexed program control
information signal is simultaneously transmitted along with the
multiplexed television programs so that video displays can be
generated using the program control information signal and so

7d

that the downstream displays of the television programs can be selected and controlled by the viewers.

It is an object of this invention to provide a system for efficiently organizing television programs to be offered to viewers.

5 It is an object of this invention to provide an Operations Center for a television program delivery system.

It is an object of this invention to provide an Operations Center for a television program delivery system which can gather television programming in a variety of formats, package the programs, and deliver the packaged programs.

10 It is an object of this invention to provide an Operations Center for a program delivery system which presents programming viewing options to the consumer through a user friendly interface which allows the consumer to easily select from among the many program choices.

15 It is an object of this invention to provide an Operations Center that is capable of handling video/audio programming in different formats.

20 It is an object of this invention to provide an Operations Center capable of offering interactive television, high definition television (HDTV) and/or other advanced television features.

It is an object of this invention to provide an Operations Center that can control software and program features at the cable headend.

5 It is an object of this invention to provide an Operations Center that can control and if necessary reprogram set top terminals.

It is an object of this invention to provide an Operations Center for a digital program delivery system.

10 It is an object of this invention to provide an Operations Center that designs program menus.

It is an object of this invention to provide an Operations Center that uses data on programs viewed to create or aid in the selection of program line-ups.

15 It is an object of this invention to provide a computer assisted program packaging system for a television program delivery system.

20 These and other objects and advantages of the invention will become obvious to those skilled in the art upon review of the following description, the attached drawings and appended claims.

DESCRIPTION OF THE DRAWINGS

Figure 1 is a diagram of the primary components of the television delivery system.

25 Figure 2 is an overview of the television delivery system operations.

Figure 3 is a schematic of the operation of the primary components of the system.

30 Figure 4 is a schematic of the primary components of the Computer Assisted Packaging System (CAP).

Figure 5 is a more detailed schematic of the hardware of the Operations Center and CAP.

2151458

9

Figure 6a is a chart of the program control information carried by the program control information signal.

Figure 6b shows a bit-wise data format for program control information.

5 Figure 7 is a block diagram showing a Delivery Control Processor Unit and a Computer Assisted Packaging Apparatus.

Figure 8 is a schematic of the subroutines for the CAP software.

10 Figure 9 is a software flowchart representing CAP operations.

Figure 10 is a diagram of the database structure for the databases supporting the operations of the CAP.

Figure 11 is a block diagram of the Operations Center and Master Control Site.

15 Figure 12 is a block diagram of the computer assisted packaging shown in figure 11.

Figure 13 is a flow chart of the processing occurring at the Operations Center.

20 Figure 14 is a diagram of the bandwidth allocation for a 750 Mhz system.

Figure 15 is a diagram/chart of the compressed channel allocation for the system.

25 Figure 16 is a diagram showing how three cable television systems each with a different bandwidth may use the program delivery system and operations center of the present invention simultaneously.

30 Figure 17 is a diagram showing three different cable headend systems, each system receiving the entire satellite signal and stripping those parts of the signal which cannot be handled by the local cable system.

2151458

Figure 18 is a diagram showing dynamic change in bandwidth allocation from a typical week day prime time program signal to a Saturday afternoon program signal.

5 Figure 19 is a drawing of a broadcast television menu screen to be displayed on a set top terminal.

Figure 20 is a drawing of a hit movie menu screen to be displayed on a set top terminal.

10 Figure 21 is a drawing of a hit movie description menu screen to be displayed on a set top terminal.

DETAILED DESCRIPTION OF THE PREFERRED EMBODIMENT

A. Television Program Delivery System Description

1. Introduction

15 Figure 1 shows the present invention as part of an expanded cable television program delivery system 200 that dramatically increases programming capacity using compressed transmission of television program signals. Developments in digital bandwidth compression technology
20 now allow much greater throughput of television program signals over existing or slightly modified transmission media. The program delivery system 200 shown provides subscribers with a user friendly interface to operate and exploit a six-fold or more increase in current program delivery capability.

25 Subscribers are able to access an expanded television program package and view selected programs through a menu-driven access scheme that allows each subscriber to select individual programs by sequencing a series of menus. The menus are sequenced by the subscriber using simple
30 alpha-numeric and iconic character access or moving a cursor or highlight bar on the TV screen to access desired programs by simply pressing a single button, rather than recalling from

memory and pressing the actual two or more digit numeric number assigned to a selection. Thus, with the press of a single button, the subscriber can advance from one menu to the next. In this fashion, the subscriber can sequence the menus and select a program from any given menu. The programs are grouped by category so that similar program offerings are found on the same menu.

2. Major System Components

In its most basic form, the system uses a program delivery system 200 in conjunction with a conventional concatenated cable television system 210. The program delivery system 200 generally includes (i) at least one operations center 202, where program packaging and control information are created and then assembled in the form of digital data, (ii) a digital compression system, where the digital data is compressed, combined/multiplexed, encoded, and mapped into digital signals for satellite transmission to the cable headend 208, and (iii) a set of in-home decompressors. The program delivery system 200 transports the digital signals to the cable headend 208 where the signals are transmitted through a concatenated cable television system 210. Within the cable headend 208, the received signals may be decoded, demultiplexed, managed by a local central distribution and switching mechanism, combined and then transmitted to the set top terminal 220 located in each subscriber's home over the cable system 210. Although concatenated cable systems 210 are the most prevalent transmission media to the home, telephone lines, cellular networks, fiberoptics, Personal Communication Networks and similar technology for transmitting to the home can be used interchangeably with this program delivery system 200.

2151458

The delivery system 200 has a reception region 207 with an in-home decompression capability. This capability is performed by a decompressor housed within a set top terminal 220 in each subscriber's home. The decompressor remains transparent from the subscriber's point of view and allows any of the compressed signals to be demultiplexed and individually extracted from the composite data stream and then individually decompressed upon selection by the subscriber. The decompressed video signals are converted into analog signals for television display. Such analog signals include NTSC formatted signals for use by a standard television. Control signals are likewise extracted and decompressed and then either executed immediately or placed in local storage such as a RAM. Multiple sets of decompression hardware may be used to decompress video and control signals. The set top terminal 220 may then overlay or combine different signals to form the desired display on the subscriber's television. Graphics on video or picture-on-picture are examples of such a display.

Although a single digital compression standard (e.g., MPEG) may be used for both the program delivery system 200 and the concatenated cable system 210, the compression technique used may differ between the two systems. When the compression standards differ between the two media, the signals received by the cable headend 208 must be decompressed before transmission from the headend 208 to the set top terminals 220. Subsequently, the cable headend 208 must recompress and transmit the signals to the set top terminal 220, which would then decompress the signals using a specific decompression algorithm.

The video signals and program control signals received by the set top terminal 220 correspond to specific television

programs and menu selections that each subscriber may access through a subscriber interface. The subscriber interface is a device with buttons located on the set top terminal 220 or on a portable remote control 900. In the preferred system embodiment, the subscriber interface is a combined alpha-character, numeric and iconic remote control device 900, which provides direct or menu-driven program access. The preferred subscriber interface also contains cursor movement and go buttons as well as alpha, numeric and iconic buttons. This subscriber interface and menu arrangement enables the subscriber to sequence through menus by choosing from among several menu options that are displayed on the television screen. In addition, a user may bypass several menu screens and immediately choose a program by selecting the appropriate alpha-character, numeric or iconic combinations on the subscriber interface. In the preferred embodiment, the set top terminal 220 generates the menus that are displayed on the television by creating arrays of particular menu templates, and the set top terminal 220 displays a specific menu or submenu option for each available video signal.

3. Operations Center and Digital Compression System

The operations center 202 performs two primary services, packaging television programs and generating the program control information signal. At the operations center 202, television programs are received from external program sources in both analog and digital form. Figure 2 shows an embodiment of the operations center receiving signals from various external sources 212. Examples of the external program sources are sporting events, children's programs, specialty channels, news or any other program source that

2151458

can provide audio or visual signals. Once the programs are received from the external program sources, the operations center 202 digitizes (and preferably compresses) any program signals received in analog form. The operations center 202 may also maintain an internal storage of programs. The internally stored programs may be in analog or digital form and stored on permanent or volatile memory sources, including magnetic tape or RAM. Subsequent to receiving programming, the operations center 202 packages the programs into the groups and categories which provide the optimal marketing of the programs to subscribers. For example, the operations center 202 may package the same programs into different categories and menus for weekday, prime-time viewing and Saturday afternoon viewing. Also, the operations center 202 packages the television programs in a manner that enables both the various menus to easily represent the programs and the subscribers to easily access the programs through the menus.

The packaging of the digital signals is typically performed at the operations center 202 by computer assisted packaging equipment (CAP). The CAP system normally includes at least one computer monitor, keyboard, mouse, and standard video editing equipment. A programmer packages the signals by entering certain information into the CAP. This information includes the date, time slot, and program category of the various programs. The programmer and the CAP utilize demographic data and ratings in performing the packaging tasks. After the programmer selects the various programs from a pool of available programs and inputs the requisite information, the programmer, with assistance from the CAP, can select the price and allocate transponder space for the various programs. After the

process is complete, the CAP displays draft menus or program schedules that correspond to the entries of the programmer. The CAP may also graphically display allocation of transponder space. The programmer may edit the menus and transponder allocation several times until satisfied with the programming schedule. During the editing, the programmer may direct the exact location of any program name on a menu with simple commands to the CAP.

The packaging process also accounts for any groupings by satellite transponder which are necessary. The operations center 202 may send different groups of programs to different cable headends 208 and/or set top terminals 220. One way the operations center 202 may accomplish this task is to send different program packages to each transponder. Each transponder, or set of transponders, then relays a specific program package to specific cable headends 208 and/or set top terminals 220. The allocation of transponder space is an important task performed by the operations center 202.

The operations center 202 may also "insert" directions for filling local available program time in the packaged signal to enable local cable and television companies to fill the program time with local advertising and/or local programming. Consequently, the local cable headends 208 are not constrained to show only programs transmitted from the operations center 202. New set top converters will incorporate both digital and analog channels. Therefore, the cable headend 208 may combine analog signals with the digital signals prior to transmitting the program signals to the set top terminals 220.

After the CAP packages the programs, it creates a program control information signal to be delivered with the

2151458

program package to the cable headend 208 and/or set top terminal 220. The program control information signal contains a description of the contents of the program package, commands to be sent to the cable headend 208 and/or set top terminal 220, and other information relevant to the signal transmission.

In addition to packaging the signal, the operations center 202 employs digital compression techniques to increase existing satellite transponder capacity by at least a 4:1 ratio, resulting in a four-fold increase in program delivery capability. A number of digital compression algorithms currently exist which can achieve the resultant increase in capacity and improved signal quality desired for the system. The algorithms generally use one or more of three basic digital compression techniques: (1) within-frame (intraframe) compression, (2) frame-to-frame (interframe) compression, and (3) within carrier compression. Specifically, in the preferred embodiment, the MPEG 2 compression method is used. After digital compression, the signals are combined (multiplexed) and encoded. The combined signal is subsequently transmitted to various uplink sites 204.

There may be a single uplink site 204 or multiple uplink sites (represented by 204', shown in phantom in Figure 1) for each operation center 202. The uplink sites 204 may either be located in the same geographical place or may be located remotely from the operations center 202. Once the composite signal is transmitted to the uplink sites 204, the signal may be multiplexed with other signals, modulated, upconverted and amplified for transmission over satellite. Multiple cable headends 208 may receive such transmissions.

2151458

17

In addition to multiple uplinks, the delivery system 200 may also contain multiple operations centers. The preferred method for using multiple operations centers is to designate one of the operations centers as a master operations center and to designate the remaining operations centers as slave operations centers. In this configuration, the master operations center coordinates various functions among the slave operations centers such as synchronization of simultaneous transmissions and distributes the operations workload efficiently.

4. Cable Headend

After the operations center 202 has compressed and encoded the program signals and transmitted the signals to the satellite, the cable headend 208 receives and further processes the signals before they are relayed to each set top terminal 220. Each cable headend site is generally equipped with multiple satellite receiver dishes. Each dish is capable of handling multiple transponder signals from a single satellite and sometimes from multiple satellites.

With reference to Figure 3, as an intermediary between the set top terminals 220 and the operations center 202 and master control uplink site 211 (or other remote site), the cable headend 208 performs two primary functions. First, the cable headend 208 acts as a distribution center, or signal processor, by relaying the program signal to the set top terminal 220 in each subscriber's home. In addition, the cable headend 208 acts as a network controller 214 by receiving information from each set top terminal 220 and passing such information on to an information gathering site such as the operations center 202.

Figure 3 shows an embodiment where the cable headend 208 and the subscriber's home are linked by certain

2151458

communications media 216. In this particular embodiment, analog signals, digitally compressed signals, other digital signals and up-stream/interactivity signals are sent and received over the media 216. The cable headend 208 provides such signaling capabilities in its dual roles as a signal processor 209 and network controller 214.

As a signal processor 209, the cable headend 208 prepares the program signals that are received by the cable headend 208 for transmission to each set top terminal 220. In the preferred system, the signal processor 209 re-routes or demultiplexes and recombines the signals and digital information received from the operations center 202 and allocates different portions of the signal to different frequency ranges. Cable headends 208 which offer different subscribers different program offerings may allocate the program signals from the operations center 202 in various manners to accommodate different viewers. The signal processor 209 may also incorporate local programming and/or local advertisements into the program signal and forward the revised signal to the set top terminals 220. To accommodate this local programming availability, the signal processor 209 must combine the local signal in digital or analog form with the operations center program signals. If the local cable system uses a compression standard that is different than the one used by the operations center 202, the signal processor 209 must also decompress and recompress incoming signals so they may be properly formatted for transmission to the set top terminals 220. This process becomes less important as standards develop (i.e., MPEG 2). In addition, the signal processor 209 performs any necessary signal decryption and/or encryption.

2151458

19

As a network controller 214, the cable headend 208 performs the system control functions for the system. The primary function of the network controller 214 is to manage the configuration of the set top terminals 220 and process signals received from the set top terminals 220. In the preferred embodiment, the network controller 214 monitors, among other things, automatic poll-back responses from the set top terminals 220 remotely located at each subscribers' home. The polling and automatic report-back cycle occurs frequently enough to allow the network controller 214 to maintain accurate account and billing information as well as monitor authorized channel access. In the simplest embodiment, information to be sent to the network controller 214 will be stored in RAM within each subscriber's set top terminal 220 and will be retrieved only upon polling by the network controller 214. Retrieval may, for example, occur on a daily, weekly or monthly basis. The network controller 214 allows the system to maintain complete information on all programs watched using a particular set top terminal 220.

The network controller 214 is also able to respond to the immediate needs of a set top terminal 220 by modifying a program control information signal received from the operations center 202. Therefore, the network controller 214 enables the delivery system to adapt to the specific requirements of individual set top terminals 220 when the requirements cannot be provided to the operations center 202 in advance. In other words, the network controller 214 is able to perform "on the fly programming" changes. With this capability, the network controller 214 can handle sophisticated local programming needs such as, for example, interactive television services, split screen video, and

2151458

20

selection of different foreign languages for the same video. In addition, the network controller 214 controls and monitors all compressors and decompressors in the system.

5 The delivery system 200 and digital compression of the preferred embodiment provides a one-way path from the operations center 202 to the cable headend 208. Status and billing information is sent from the set top terminal 220 to the network controller 214 at the cable headend 208 and not directly to the operations center 202. Thus, program
10 monitoring and selection control will take place only at the cable headend 208 by the local cable company and its decentralized network controllers 214 (i.e., decentralized relative to the operations center 202, which is central to the program delivery system 200). The local cable company will
15 in turn be in communication with the operations center 202 or a regional control center (not shown) which accumulates return data from the set top terminal 220 for statistical or billing purposes. In alternative system embodiments, the operations center 202 and the statistical and billing sites are
20 collocated. Further, telephone lines with modems are used to transfer information from the set top terminal 220 to the statistical and billing sites.

5. Set Top Terminal

25 The set top terminal 220 is the portion of the delivery system 200 that resides in the home of a subscriber. The set top terminal 220 is usually located above or below the subscriber's television, but it may be placed anywhere in or near the subscriber's home as long as it is within the range of the subscriber's remote control device 900. In some aspects,
30 the set top terminal 220 may resemble converter boxes already used by many cable systems. For instance, each set top terminal 220 may include a variety of error detection.

2151458

21

5 decryption, and coding techniques such as anti-taping encoding. However, it will become apparent from the discussion below that the set top terminal 220 is able to perform many functions that an ordinary converter box cannot perform.

10 The set top terminal 220 has a plurality of input and output ports to enable it to communicate with other local and remote devices. The set top terminal 220 has an input port that receives information from the cable headend 208. In addition, the unit has at least two output ports which provide communications from the set top terminal 220 to a television and a VCR. Certain menu selections may cause the set top terminal 220 to send control signals directly to the VCR to automatically program or operate the VCR. Also, the set top terminal 220 contains a phone jack which can be used for maintenance, trouble shooting, reprogramming and additional customer features. The set top terminal 220 may also contain stereo/audio output terminals and a satellite dish input port.

20 Functionally, the set top terminal 220 is the last component in the delivery system chain. The set top terminal 220 receives compressed program and control signals from the cable headend 208 (or, in some cases, directly from the operations center 202). After the set top terminal 220 receives the individually compressed program and control signals, the signals are demultiplexed, decompressed, converted to analog signals (if necessary) and either placed in local storage (from which the menu template may be created), executed immediately, or sent directly to the television screen.

30 After processing certain signals received from the cable headend 208, the set top terminal 220 is able to store menu

2151458

templates for creating menus that are displayed on a subscriber's television by using an array of menu templates. Before a menu can be constructed, menu templates must be created and sent to the set top terminal 220 for storage. A

5 microprocessor uses the control signals received from the operations center 202 or cable headend 208 to generate the menu templates for storage. Each menu template may be stored in volatile memory in the set top terminal 220. When

10 the set top terminal receives template information it demultiplexes the program control signals received from the cable headend 208 into four primary parts: video, graphics, program logic and text. Each menu template represents a different portion of a whole menu, such as a menu background, television logo, cursor highlight overlay, or other

15 miscellaneous components needed to build a menu. The menu templates may be deleted or altered using control signals received from the operations center 202 or cable headend 208.

Once the menu templates have been stored in memory,

20 the set top terminal 220 can generate the appropriate menus. In the preferred embodiment, the basic menu format information is stored in memory located within the set top terminal 220 so that the microprocessor may locally access the information from the set top terminal instead of from an

25 incoming signal. The microprocessor next generates the appropriate menus from the menu templates and the other menu information stored in memory. The set top terminal 220 then displays specific menus on the subscriber's television screen that correspond to the inputs the subscriber

30 selects.

If the subscriber selects a specific program from a menu, the set top terminal 220 determines on which channel

2151458

23

the program is being shown, demultiplexes and extracts the single channel transmitted from the cable headend 208. The set top terminal 220 then decompresses the channel and, if necessary, converts the program signal to an analog NTSC signal to enable the subscriber to view the selected program. The set top terminal 220 can be equipped to decompress more than one program signal, but this would unnecessarily add to the cost of the unit since a subscriber will generally only view one program at a time. However, two or three decompressors may be desirable to provide picture-on-picture capability, control signal decompression, enhanced channel switching or like features.

In addition to menu information, the set top terminal 220 may also store text transmitted from the cable headend 208 or the operations center 202. The text may inform the subscriber about upcoming events, billing and account status, new subscriptions, or other relevant information. The text will be stored in an appropriate memory location depending on the frequency and the duration of the use of the textual message.

Also, optional upgrades are available to enhance the performance of a subscriber's set top terminal 220. These upgrades may consist of a cartridge or computer card (not shown) that is inserted into an expansion slot in the set top terminal 220 or may consist of a feature offered by the cable headend 208 or operations center 202 to which the user may subscribe. Available upgrades may include on line data base services, interactive multi-media services, access to digital radio channels, and other services.

In the simplest embodiment, available converter boxes such as those manufactured by General Instruments or Scientific Atlanta, may be modified and upgraded to perform

2151458

the functions of a set top terminal 220. The preferred upgrade is a circuit card with a microprocessor which is electronically connected to or inserted into the converter box.

5 6. Remote Control Device

 The primary conduit for communication between the subscriber and the set top terminal 220 is through the subscriber interface, preferably a remote control device 900. Through this interface, the subscriber may select desired programming through the system's menu-driven scheme or by directly accessing a specific channel by entering the actual channel number. Using the interface, the subscriber can navigate through a series of informative program selection menus. By using menu-driven, iconic or alpha-character access, the subscriber can access desired programs by simply pressing a single button rather than recalling from memory and pressing the actual channel number to make a selection. The subscriber can access regular broadcast and basic cable television stations by using either the numeric keys on the remote control 900 (pressing the corresponding channel number), or one of the menu icon selection options.

10
15
20

 In addition to enabling the subscriber to easily interact with the cable system 200, the physical characteristics of the subscriber interface 900 should also add to the user friendliness of the system. The remote control 900 should easily fit in the palm of the user's hand. The buttons of the preferred remote control 900 contain pictorial symbols that are easily identifiable by the subscriber. Also, buttons that perform similar functions may be color coordinated and consist of distinguishing textures to increase the user friendliness of the system.

25
30

7. Menu-Driven Program Selection

The menu-driven scheme provides the subscriber with one-step access to all major menus, ranging from hit movies to sport specials to specialty programs. From any of the major menus, the subscriber can in turn access submenus and minor menus by cursor or alpha-character access.

There are two different types of menus utilized by the preferred embodiment, the Program Selection menus and the During Program menus. The first series of menus, Program Selection menus, consists of an Introductory, a Home, Major menus, and Submenus. The second series of menus, During Program menus, consists of two primary types, Hidden menus and the Program Overlay menus.

Immediately after the subscriber turns on the set top terminal 220, the Introductory menu welcomes the subscriber to the system. The Introductory menu may display important announcements from the local cable franchise, advertisements from the cable provider, or other types of messages. In addition, the Introductory menu can inform the subscriber if the cable headend 208 has sent a personal message to the subscriber's particular set top terminal 220.

After the Introductory menu has been displayed the subscriber may advance to the next level of menus, namely the Home menu. In the preferred embodiment, after a certain period of time, the cable system will advance the subscriber by default to the Home menu. From the Home menu, the subscriber is able to access all of the programming options. The subscriber may either select a program directly by entering the appropriate channel number from the remote control 900, or the subscriber may sequence through incremental levels of menu options starting from the Home

2151458

menu. The Home menu lists categories that correspond to the first level of menus called Major menus.

5 If the subscriber chooses to sequence through subsequent menus, the subscriber will be forwarded to the Major menu that corresponds to the chosen category from the Home menu. The Major menus further refine a subscriber's search and help guide the subscriber to the selection of his choice.

10 From the Major menus, the subscriber may access several submenus. From each submenu, the subscriber may access other submenus until the subscriber finds a desired television program. Similar to the Major menu, each successive level of Submenus further refines the subscriber's search. The system also enables the subscriber to skip 15 certain menus or submenus and directly access a specific menu or television program by entering the appropriate commands on the remote control 900.

20 The During program menus (including Hidden Menus and Program Overlay Menus) are displayed by the set top terminal 220 only after the subscriber has selected a television program. In order to avoid disturbing the subscriber, the set top terminal 220 does not display the Hidden Menus until the subscriber selects the appropriate option to display a Hidden Menu. The Hidden Menus contain 25 options that are relevant to the program selected by the viewer. For example, a Hidden Menu may contain options that enable a subscriber to enter an interactive mode or escape from the selected program.

30 Program Overlay Menus are similar to Hidden Menus because they occur during a program and are related to the program being viewed. However, the Program Overlay Menus are displayed concurrently with the program selected by the

subscriber. Most Program Overlay Menus are small enough on the screen to allow the subscriber to continue viewing the selected program comfortably.

B Operations Center With Computer Assisted Packaging System

5

Figure 4 broadly shows the configuration for the computer assisted packaging system (CAP) 260 of the Operations Center 202. The primary components of the CAP 260 consist of multiple packager workstations 262, a central processing unit 264, video/audio editing equipment 266, and one or more databases 268 and 269. Additional remotely located databases, such as local video storage database 267, and buffers 271 and controllers 272 for external program feeds make up the peripherals of the CAP system 260.

10

The heart of the CAP 260 is a central processing unit 264 which communicates with all the component parts of the CAP 260. The central processing unit 264 can be a powerful PC, a mini-computer, a mainframe or a combination of computing equipment running in parallel. The central processing unit 264 includes all the necessary interconnections to control peripheral equipment such as the external video controls 272. The central processing unit 264 has sufficient memory 274 to store the program instructions of the subroutines which operate the CAP 260.

15

20

The CAP 260 receives data from one or more databases, such as the Operations Center Database 268 and the Cable Franchise Information Database 269 shown in Figure 4. In addition, separate databases are maintained of viewer information, such as demographics and programs viewed. The CAP 260 can control the reception of external sources by enabling and disabling the external video controls 272. The external video controls 272 include buffers to delay as

25

30

2151458

necessary external programs received by the Operations Center 202.

5 The functions of the video/audio equipment 266 include digitizing analog programs, digitizing and compressing analog programs (in a single step, e.g., MPEG), and compressing digital program signals as requested by the central processing unit 264.

10 The CAP 260 receives video and audio from two sources: internally from a local video storage 267 and externally from external sources through external video controls 272. When necessary, video is manipulated, formatted and/or digitized using video/audio equipment 266 which is controlled by CAP 264.

15 Referring back to Figure 2, an overview of an operating cable television menu driven program delivery system 200 highlighting various external programming signal sources 212 is depicted. The Operations Center 202 is shown receiving external programming signals which correspond to particular programming categories that are available for a subscriber's
20 viewing. These external signals may be in analog or digital form and may be received via landline, microwave transmission, or satellite. Some of these external signals may be transmitted from the program source 212 to the Operations Center 202 in compressed digital format or other
25 nonstandard digital formats. These external signals are received and packaged with programming that is stored at the Operations Center 202.

30 Examples of external program sources 212 shown in Figure 2 are: Sporting events, children's programs, documentaries, high definition TV sources, specialty channels, interactive services, weather, news, and other nonfiction or entertainment. Any source that can provide

either audio or video or both may be utilized to provide programming to the Operations Center 202.

5 In order to achieve the required throughput of video and audio information for the system, digital compression techniques are employed. A television signal is first digitized. The object of digitization is two-fold: First, in the case of an analog signal, like a television picture, digitization allows the signal to be converted from a waveform into a digital binary format. Secondly, through the use of digital compression
10 techniques, standard digital formats are designed to have the resulting pictures or video stills take up less space on their respective storage mediums. Essentially, as described below, a standard digital format will define the method of compression used.

15 There are three basic digital compression techniques: within-frame (intraframe), frame-to-frame (interframe), and within-carrier. Intraframe compression processes each frame in a television picture to contain fewer visual details and, therefore, the picture contains fewer digital bits. Interframe compression transmits only changes between
20 frames, thus omitting elements repeated in successive frames. Within-carrier compression allows the compression ratio to dynamically vary depending upon the amount of changes between frames. If a large number of changes occur between frames, the compression ratio drops from, for
25 example, sixteen-to-one to eight-to-one. If action is intense, the compression ratio may dip to four to one.

30 Several standard digital formats representing both digitizing standards and compression standards have been developed. For example, JPEG (joint photographic experts group) is a standard for single picture digitization. Motion picture digitization may be represented by standards such as

2151458

MPEG or MPEG2 (motion picture engineering group specifications). Other proprietary standards have been developed in addition to these. The preferred embodiment uses the MPEG-2 standard of coding and those of ordinary skill in the art are presumed to be familiar with the MPEG-2 standard. The MPEG-2 Systems Working Draft Proposal from the Systems Committee of the International Organization For Standardization, document ISO/IE JT1/SC29/WG11 "N0531" MPEG93 dated September 10, 1993, is hereby incorporated by reference. Although MPEG and MPEG2 for motion pictures are preferred in the present invention, any reliable digital format with compression may be used with the present invention.

Various hybrids of the above compression techniques have been developed by several companies including AT&T, Compression Labs, Inc., General Instrument, Scientific-Atlanta, Phillips, and Zenith. As is known by those skilled in the art, any of the compression techniques developed by these companies, and other known techniques, may be used with the present invention.

With reference to Figure 4, the human intervention in this system is conducted by a programmer or program packager operating from the one or more work stations 262 connected to the system. These work stations 262 are preferably intelligent work stations with large CRT screens. In the preferred embodiment, a suitable keyboard, mouse and color monitor are used with the workstation. From these work stations, the packager can create program lineups, prioritize programs, initiate dynamic menu allocation, initiate dynamic bandwidth allocation, design menus, place program names and descriptions onto menus, create menus with still and live video, move text on menus, change the colors of

2151458

31

objects on menus and perform various other tasks for the program delivery system 200.

5 Almost any Operations Center 202 function that normally requires human intervention can be conducted at the packager workstation 262. Although data entry for the databases can be performed manually at the workstations 262, it is preferred that the data entry be completed through electronic transfers of information. Alternatively, the data can be loaded from customary portable storage media such as
10 magnetic disks or tape.

An integral part of the Computer Assisting Packaging system is the retrieval of viewer data, and the assimilation of that data into the program packaging method (especially the menu configuration) as discussed in reference to Figure 8 MII
15 402. This involves two main steps, first, retrieval of raw data from the set top terminals, and then filtering and presenting that data. Each headend 208 compiles the viewer data, and then sends it verbatim to the Operations Center 202. This raw data is necessary because different responsibilities of the
20 Operations Center 202 require different parts of the raw information. Also a record must be kept of overall data. Once the data is assembled at the Operations Center 202, the data is filtered for each application.

The raw data gathered includes but is not limited to:

- 25
- What programs a viewer purchased and when it was purchased
 - What channel a specific viewer watched and for how long.

This information can then be used to calculate the
30 following:

- How many viewers watched a particular program.

2151458

- Peak viewing times for different categories of shows.
- Buy rates for particular menu positions.

5 Menu creation, both automatically and manually, is one of the major CAP functions that involves the incorporation of the raw data. An automated software procedure (such as the EIS) analyzes the data and, using certain heuristics, creates the menus.

10 One heuristic, for example, is that when a show is not ordered frequently, it is moved closer to the top of the menu for greater visibility. The filtering of the data allows it to be sorted and indexed for display to the user. The program data can be filtered into a new database containing program names and indexed by the number of times each program was
15 purchased. The data can also be indexed by buy times and program categories.

Certain metrics are established to help in evaluating the data. Using the EIS or similar software, sales by menu placement, cost, category and lifespan can be pulled up for
20 viewing in graphic presentation. The graphic presentation, in the form of line or bar graphs, help the packager recognize any trends in the data. For example, the first movie on a movie menu might not have sold as well as a second movie listed. A chart can be pulled up to reveal that the first movie
25 has been at the top of the menu for two weeks and buy rates are naturally falling off. Steps can then be taken to move items in the menus to correct this, though many of these steps are automated in the menu creation system. Suggested changes can be displayed to help the user in this task.

30 The automated procedures create menus that are distinct between headends 208 because of demographic differences in the viewing audience. To help with this, a

5 separate database of viewer demographics exists and is frequently updated. The headends 208 are able to alter the menu positions in order to further tailor the presentation, or to add local shows. Any changes to the menus are sent back
10 to the Operations Center 202 at the same time as the viewer data, in order to prevent erroneous data analysis. Menu changes at the cable headend are described in detail in co-pending patent application Ser. No. PCT/US93/11616, entitled Network Controller for a Cable Television System,
15 filed by the same assignee.

Another use for the indexed data is creation of marketing reports. Programming changes are helped by accurate information on viewer preference. Also viewer purchasing trends, and regional interests can be tracked.

15 In the preferred embodiment, an Executive Information System (EIS) is used to give high level access to both "buy" (what the customer purchases) and "access" (when the product was viewed, how often and duration) data. The EIS represents information in both a graphical and
20 summary report format. "Drill down" functions in the EIS help the packager derive the appropriate product (product refers to programs, events or services) mix.

The purpose of the EIS is to provide an on-line software tool that will allow for real-time evaluation of current
25 product positioning. The design of the system consists of user friendly icons to guide the user through available functions. The functionality in the system provides general information on current programming sales status. By working through the tiers in the system, the user has access to more
30 specific information. The system is designed to shield the user from a long learning curve and information overload.

2151458

34

5 The graphical tools allow for analysis of current data through the use of multiple graph types such as line graphs, bar and pie charts. These tools will allow the user to manipulate independent variables such as time (hour, day of the week, week, month), demographic information, program category information (genre, property, events), headend information and pricing information for determining the appropriate programming mix within the allotted time slots.

10 The system also allows the packager to derive expected monetary returns through program line-ups by integrating outside industry databases. For instance, the system could be used to determine expected returns from a particular program by correlating buy information from the existing programs in the line up with a viewer ratings service database
15 to determine the outcome of programs within a particular genre not in the current line up.

Report tools within the EIS aggregate buy access at the highest level. Due to the volume of available information statistical analysis methods are used for deriving marketing
20 intelligence within the EIS.

A yield management tool is incorporated within the EIS. The yield management tool encompasses operations research techniques, statistical methods and neural net technology to decide program mix as it pertains to program
25 substitutes, program complements, time slice positioning, repetitions and menu positioning.

This system is automated to the extent of providing viable alternative as to the proposed product mix. The system encompasses a Monte Carlo simulation for developing
30 alternative product mix scenarios. The system feeds from both internal data and external industry data sources to provide expected revenue projections for the different

2151458

35

scenarios. Other software subroutines of the CAP will automatically call upon the EIS to assist the program in important decision making, such as menu configuration and transponder allocation. Human interaction is required to
5 change marketing parameters for fine tuning the desired product scheduling.

Although the packaging of the program information and programs, including the creation of program control information, program lineup and menu designing
10 configuration, is conducted at the CAP 260, all other functions of the Operations Center 202 can be controlled by a second separate processing unit (shown in Figure 5 at 270). This second processing unit 270 is the Delivery Control
15 Processing Unit 270, and can perform the tasks of incorporating the program control information signal from the CAP 260, coordinating the receipt and combining of external program video/audio and internal video/audio and combining the signals as necessary for transmission. This
20 distribution of functions among the CAP 260 and Delivery Control Processing Unit 270 allows for greater speed and ease of use.

Figure 5 shows a more detailed diagram of the CAP 260 and the Delivery Control Processor Unit 270. Once external and stored digital and analog sources have been converted
25 into a standard digital format 274, they are input into standard digital multiplex equipment 273 (of the type manufactured by Scientific Atlanta, General Instruments, and others). Additionally, the Program Control Information Signal 276 is input into the digital multiplex equipment 273. These
30 inputs 274, 276 are multiplexed appropriately under the control of the Delivery Control Processor Unit 270 as commanded by the CPU 264. The Delivery Control Processor

2151458

Unit 270 is also responsible for the generation of the Program Control Information Signal 276 based on information received from the CPU 264. The Delivery Control Processor Unit 270 allows for the off-loading of real-time and near real-time tasks from the CPU 264. The CPU 264, as described earlier, processes information within its database and provides user access to the CAP 260 via multiple user workstations 262. The high-speed digital output 278 from the digital multiplex equipment 273 is then sent on to the compression (if necessary), multiplexing, modulation and amplification hardware, represented at 279.

C. The Program Control Information Signal

The following table, TABLE A, is an example of some information that can be sent in the program control information signal to the set top terminals 220. The program control information signal generated by the Operations Center 202 provides data on the scheduling and description of programs via the network controller 214 or, in an alternate configuration, directly to the set top terminal 220 for display to the subscriber.

In the preferred embodiment, the program control information signal 276 is stored and modified by the network controller 214 and sent to the set top terminal 220 in the form of a set top terminal control information stream (STTCIS). This configuration accommodates differences in individual cable systems and possible differences in set top converter or terminal devices. The set top terminal 220 of the present invention integrates either the program control signal 276 or the STTCIS, together with data stored in the memory of the set top terminal 220, to generate on-screen menu displays for assisting the subscriber in choosing programs for viewing. (Throughout the description the term

“program control information” is being used to indicate control information coming from the cable headend 208 to the set top terminal 220, whether it is sent directly from the Operations Center 202, processed by the network controller 214, and then forwarded to the set top terminal as STTCIS, or transmitted over telephone lines.)

With further reference to TABLE A below, the types of information that can be sent via the program control signal include: number of program categories, names of program categories, what channels are assigned to a specific category (such as specialty channels), names of channels, names of programs on each channel, program start times, length of programs, description of programs, menu assignment for each program, pricing, whether there is a sample video clip for advertisement for the program, and any other program, menu or product information.

The goal of the menu driven program selection system of the present invention, described in greater detail in a co-pending U.S. Patent application entitled SET TOP TERMINAL FOR CABLE TELEVISION DELIVERY SYSTEM, Ser. No. PCT/US93/11618, owned by the assignee of the present invention is to allow the subscriber to choose a program by touring through a series of menus utilizing a remote control 900 for cursor movement. The final choice in the series of menus will identify one particular channel and one time for activation of that channel. Armed with a channel and activation time the set top terminal 220 can display the selected program on the television for the viewer. To achieve this goal, an intelligent alpha-numeric code is assigned to each program. This alpha-numeric code identifies the category of the program, the menu in which the program should be displayed, its

2151458

transmission time(s), and the position on the menu that the program should be displayed. In a preferred embodiment, the program control information, including menu codes, is sent continuously from the Operations Center 202 to the network controller 214, and ultimately to the set top terminal 220. For example, four hours worth of programming information can be sent via the program control information signal continuously in the format shown in TABLE A.

10

TABLE A

12:00 PM

	*Program name	*Program length	*Menu code	*Description	*Video
15	1 Cheers	.5	E24	C	N
	2 Terminator	2.0	A33	Tx	S
	3 PrimeTime	1.0	D14	N	N
	4 Football Special	.5	B24	S	N
20	•				
	•				
	•				
	•				

12:30 PM

	*Program name	*Program length	*Menu code	*Description	*Video
25	1 Simpsons	.5	E14 & C13	C	S
	4 Football Game	3.0	B13	S	N
30	•				
	•				
	•				

TABLE A shows the basic information that is needed by the set top terminal 220. The program descriptions shown are coded abbreviations. For example, C stands for comedy, N for news, S for sports, A for cartoons, and TX for text. If

2151458

39

there is a textual description for a program, such as a movie, the description may be given following that program's coded description or may be communicated following the four hours of programming information. As is shown in the coded listing, program descriptions for programs greater than a half hour in length need not be repeated (each half hour). The video description code informs the set top terminal 220 whether there is still or live video available to advertise the program.

10 For example, a sporting program may be assigned a code of B35-010194-1600-3.25-Michigan St. vs. USC. The letter B would assign the program to category B, sports. The second alpha-numeric character number 3 would assign the program to the third menu of the sports category. The third character of the code, number 5, assigns the program to the fifth program slot on the third menu. The next six characters, 01/01/94, represent the date. The following four characters, 1600 represent the start time which is followed by the length of the program and the program name. This entry represents a sports show, a college football game, which will be aired at 4:00PM on New Years day 1994.

25 In the 12:30 Channel 1 entry of TABLE A, two menu codes are shown. By allowing two menu codes, programs that may fit under two different category descriptions may be shown in both menus to the subscriber. With this minimal amount of information being communicated to the set top terminal 220 on a regular basis, the terminal is able to determine the proper menu location for each program and the proper time and channel to activate for the subscriber after his menu selection. In the preferred embodiment, the menu codes are generated at the Operations Center 202.

2151458

5 Table B shows an example Events Table that may be downloaded to a set top terminal 220 using the Event Data file which contains information about events and pricing. As shown in the table, the three columns of the Events Table identify the field number, the field itself and the type of information downloaded in the Event Data file. The first column contains the field numbers 1 through 11. The middle column contains the corresponding field parameters, including the event type, event ID, global channel ID, price, start time, end time, start date, end date, P- icon, name and description. The third column contains corresponding field type information. As shown in this field type information typically consists of an unsigned integer; hours, minutes and seconds; months, day and year; and ASCII character identifier.

TABLE B

Field #	Field	Type
1	Event Type 1 = YCTV 2 = Pay-Per-View 3 = Reg. TV	Unsigned Int
2	Event ID	Unsigned Int
3	Global Channel ID	Unsigned Int
4	Price (in Cents)	Unsigned Int
5	Start Time	HH:MM:SS
6	End Time	HH:MM:SS
7	Start Date	MM/DD/YY
8	End Date	MM/DD/YY
9	P-Icon	ASCIIZ
10	Name	ASCIIZ
11	Description	ASCIIZ

35 Table C shows an example Event Data data file. In particular, Table C shows two data streams corresponding to two event types. The first data stream identifies a YCTV event in the first field. The second field designates the event ID,

which is 1234 in this example. The third field includes the global channel ID number two. The fourth field indicates the cost of 50 cents for this event. The fifth and sixth fields indicate the respective start and end times of 3:00 a.m. to 3:00 p.m., respectively. The seventh and eighth fields show the corresponding start and end date, designated as 8/25/93 and 8/27/93, respectively. Field nine indicates the P icon set to a graphics file. Finally, fields ten and eleven indicate the name and description of the event selected, which in this case is Sesame StreetTM and BarneyTM. The second data stream in the Event.Dat example shown in Table C includes analogous information for Terminator IVTM, which is designated in field one as a pay-per-view event.

TABLE C

Event Data Example

1	1234	2	50	03:00:00	15:00:00	08/25/93	08/27/93	pbs.pcx	Sesame Street & Barney's	Sesame Street and Barney Abstract
2	1234	2	50	20:00:00	22:00:00	08/25/93	08/25/93	t4.pcx	Terminator 4	Terminator 4 Abstract

The program control information signal 276 and STTCIS can be formatted in a variety of ways and the on-screen menus can be produced in many different ways. For instance, if the program control information signal 276 carries no menu format information, the menu format for creating the menus can be fixed in ROM at the set top terminal 220. This method allows the program control signal 276 to carry less information but has the least flexibility since the menu formats cannot be changed without physically swapping the ROM holding the menu format information. In the preferred embodiment, the menu format information is stored at the set top terminal 220 in temporary memory either in a RAM or EPROM. This configuration provides the

2151458

desired flexibility in the menu format while still limiting the amount of information needed to be communicated via the program control information signal 276. New menu format information would be sent via the program control information signal 276 or the STTCIS to the set top terminals 220 each time there was a change to a menu.

In the simplest embodiment, the menus remain fixed and only the text changes. Thus, the program control information signal 276 can be limited to primarily text and a text generator can be employed in the set top terminal 220. This simple embodiment keeps the cost of the set top terminal 220 low and limits the bandwidth necessary for the program control information. Another simple embodiment uses a separate channel full-time (large bandwidth) just for the menu information.

Figures 6a and 6b, particularly Figure 6a, show a data format 920 at the bit-level for one embodiment of a program information signal 276. This frame format consists of six fields, namely: (1) a leading flag 922 at the beginning of the message, (2) an address field 924, (3) a subscriber region designation 926, (4) a set top terminal identifier 928 that includes a polling command/response (or P/F) bit 930, (5) an information field 932, and (6) a trailing flag 934 at the end of the message.

The eight-bit flag sequence that appears at the beginning 922 and end 927 of a frame is used to establish and maintain synchronization. Such a sequence typically consists of a "01111110" bit-stream. The address field 924 designates a 4-bit address for a given set top terminal 220. The subscriber region designation 926 is a 4-bit field that indicates the geographical region in which the subscriber's set top terminal 220 is housed. The set top terminal

2151458

43

5 identifier 928 is a 16-bit field that uniquely identifies each set top terminal 220 with a 15-bit designation followed by an appended P/F bit 930. Although field size is provided by this example, a variety of sizes can be used with the present invention.

10 The P/F bit 930 is used to command a polling response 920' (Figure 6b) from the set top terminal 220 addressed. The polling response 920' is substantially similar to the from format 920, and is commonly numbered, but with a prime (') designation appended for clarity. The frame format 920 also provides a variable-length information field 932 for other data transmissions, such as information on system updates. The frame format ends with an 8-bit flag 934 (or trailing flag) that is identical in format to the leading flag 922, as set forth
15 above. Other frame formats, such as MPEG, for example, will be apparent to one skilled in the art and can be easily adapted for use with the system.

D. Software Subroutines

20 The program control information signal 276 is produced substantially by the CAP CPU 264 and the Delivery Control Processor Unit (DCPU) 270. An overview of the software modules, focusing on the processing of signals and communication between CAP CPU 264 and DCPU 270 is shown in Figure 7. The software modules for the CAP CPU
25 264 and DCPU 270 include dispatcher 484, processing 486 and communications 488, each of which performs like-named functions, as well as supporting database 490 access. Processing within the CAP CPU 264 is controlled by the dispatcher 484 software module which may generate
30 processing commands based on user command (e.g., do something now), schedule events (e.g., do something at noon) or based on the occurrence of other events (e.g., do

2151458

something when the database is updated). The dispatcher 484 sends messages to the processing software module 486 instructing it to process information within the database 490 and generate control information for the DCPU 270. For example, based on the updating of information associated with a particular headend 208, the dispatcher 484 may command the CAP CPU 264 to regenerate headend 208 parameters, perform any required database integrity checking and send them to the DCPU 270. Also, in the case of headend 208 information processing, a filtering function (not shown) is performed which eliminates any information that does not either directly or indirectly relate to a given headend 208. Information transfer between the CAP CPU 264 and the DCPU 270 is controlled by the DCPU communications software module 488.

Information received by the DCPU 270 from the CAP CPU 264 is processed at the DCPU processing module 496 and put into a form consistent with the DCPU 270. Some of this information is used for DCPU control, while most is data to be integrated into the program control information signal 261. Some of this information is also used for miscellaneous control 494 for such things as external multiplex equipment, source material generation hardware, transmission equipment and so on. Information destined for the program control information signal 261 may be transmitted once or may be scheduled for periodic transmission. This information is integrated by the processing module 496 with other information, both internal and external. The DCPU scheduler module 497 is responsible for scheduling and regulating this data traffic. Also, the scheduler 497 may perform information filtering. For example, imbedded date/time information within the information records of interest can be used for

filtering. External pass-through control information 495 may also be incorporated into the program control information signal 261 to provide external input to this digital data stream. The DCPU multiplexer 498 is responsible for
5 multiplexing external pass-through control information. Finally, a transmission software module 499 in conjunction with appropriate communications hardware (not shown), controls the output of both the program control information signal 261 and the miscellaneous control signals 494.

10 Figure 8 is a high level diagram of CAP software subroutines and their interrelations. A Main Program (not shown) orchestrates the use of the various subroutines as needed to perform the CAP's tasks. The Packager Data Entry Interface (PDEI) 400, Marketing Information Interface (MII)
15 402, and Cable Franchise Information Access (CFIA) 404 subroutines perform the interface functions between the CAP Main Program and outside data or information. The remaining subroutines shown in the center column of Figure 8 perform the processing and manipulations necessary to the
20 functioning of the CAP 260.

The Packager Data Entry Interface (PDEI) 400 subroutine includes routines that enable the Packager to interactively enter program selections 410, start times of programs 412, price setting 414, transponder allocation 416,
25 and menu editing 418. The PDEI subroutine 400 controls the keyboard and mouse data entry by the packager and runs in concert with the processing and editing subroutines described later.

The Marketing Information Interface (MII) 402
30 subroutine interfaces the processing and editing subroutines with marketing data. This interface regularly receives programs watched information from billing sites 420, cable

2151458

headends 208, or set top terminals 220. In addition, other marketing information 422 such as the demographics of viewers during certain time periods may be received by the MII 402. The MII 402 also uses algorithms 424 to analyze the program watched information and marketing data 420, 422, and provides the analyzed information to the processing and editing subroutines. In the preferred embodiment, an Executive Information System (EIS) with a yield management subsystem is included in the MII subroutine as described above.

The Cable Franchise Information Access (CFIA) 404 subroutine receives information on cable franchises, as represented at block 426, such as the particular equipment used in a cable headend 208, the number of set top terminals 220 within a cable franchise, groupings of set top terminals 220 on concatenated cable systems 210, distribution of "high-end" cable subscribers, etc. The CFIA 404 generates a cable franchise control signal 428 which is integrated with the program control information 276 output to generate cable headend 208 specific information to be transmitted. The integration algorithm for accomplishing this resides within the Generator subroutine described herein below.

The process program line-up subroutine 430 uses information from the MII 404 and PDEI 400 to develop a program line-up. Importance weighting algorithms and best fit time algorithms are used to assign programs in time slots.

The process menu configurations subroutine 432 determines appropriate menu formats to be used and positions programs on menu screens. Information from the MII 404 and PDEI 400 are used to determine program positions on menus.

The menu display algorithms 434 displays menus as the menus would be seen by the viewer on a large CRT or color monitor.

5 The editing of menus subroutine 436 works with the menu display algorithm and PDEI 400 to allow the packager to edit menus on-the-fly during viewing of the menus.

10 The graphical transponder allocation display 438 sends information obtained from the CFIA 404 and PDEI 400 to create graphical displays enabling the packager to comprehend the allocation of transponder space across the entire television delivery system 200.

15 In a manner similar to the display and editing of menus represented at blocks 434, 436, the packager may utilize the editing transponder allocation subroutine 440 to interactively reallocate assignment of transponder space. In the preferred embodiment, the EIS with yield management may be used by the packager to assist in decisions on allocating transponder space.

20 The generator subroutine 442 creates the program control information signal for output. The Generator subroutine receives the cable franchise control signal and uses this signal to help create a custom signal for each cable headend 208.

25 The Packaging Routine 448 obtains and packages the programs, along with the program control information signal 216, for transmission to the transponders.

30 With continued reference to Figures 7, 8 and 9, the general software flow of the operations center 202 is depicted. The flow can be broken up into modules that apply to parts of the database to allow viewing, editing, and adding records to the database. The software also accomplishes

2151458

database integrity checking by restricting the user to enter only valid data, and by checking for conflicts.

5 Figure 9 shows some of the software involved in the creation of programs, events and services. This creation occurs prior to or during the processing of the program line-up 430 shown in Figure 8. With reference to Figure 9, a first step is indicated generally at 461 and includes acquiring source materials for program production at the Operations Center 202 (e.g., tape production). Once the source materials are collected 460, and entered into the database "D", they can be used to create programs 462. These programs are made up of source 'cuts' from various video/audio source materials. Once the programs have been generated and entered into the database "D", events, collections of one or more programs, are created 464. Each event is then schedule onto a service 466, with the software checking for conflicts. Each service is given run times, and days, and checked for conflicts. Once the services and events have been created, the event names can be added to the menus 468. The programs for the events and services may be stored at the Operations Center (as shown in Figure 11 at 286). Processing and manipulation of the events or records is depicted generally at 463.

25 The packager user interface (a portion of 463) for each of the creation modules works substantially identically to each of the other modules to make the interface easy to use and learn. The packager user interfaces forms a portion of the PDEI 400 shown on Figure 8. The browse system 470 is entered first and allows viewing of records, and selection of specific records. The database can be 'populated' by selection of a button, which activates a populate screen. As represented at block 471, this allows details to be deleted.

2151458

49

added or changed for events, programs, and sources. The
browse screen also allows access to the edit screen 472,
where fields in a selected record can be modified, with
conflicts or errors, in scheduling for example, being checked
continuously, as at 473 and 474.

In use, the Operations Center 202 of the present
invention performs a variety of management functions which
can be broken out into five primary areas: (1) cable headend
208 management, (2) program source management, (3)
broadcast program management, (4) internal program storage
and management, and (5) marketing, management and
customer information. A relational database, such as that
represented by Figure 10, can be used to maintain the data
associated with these areas.

Customer billing is not included in any of the above five
areas for the Operations Center 202. Although billing can be
handled by the Operations Center 202 (as shown in the
database structure 508, 511), it is preferred that billing is
handled at a remote location through traditional channels and
methods (such as Cable TV billing provided by Telecorp
corporation). Extracts of customer purchases will be
provided to the Operations Center 202. These extracts of
information will be formatted and correlated with customer
demographics for marketing purposes by the Marketing
Information Interface (MII) 402.

(1) Cable Headend Management

Management of the cable headend 208 includes the
following activities: defining the cable headend site; profiling
the viewers; determining available set top equipment;
defining the concatenated cable systems connected to the
cable headend site. This information may be stored as cable
franchise information within the Operations Center 202

2151458

51

	Description	Describes the service. The description will allow the packager to easily assign a service to a broadcast program.
5	Type	Defines the type of service. Current service types include YCTV™, Grid, Network and Other.
	Network ID	Relevant for network services. (examples: ABC, NBC, DISC™)
10	Broadcast Event	Relevant for a YCTV™ service. Identifies the current YCTV™ broadcast event assigned to the service.
15	PICON File	Name of the picture icon (PICON) assigned to the service. This picon is displayed for example on the buy screen for a pay per view event.
	Expiration Date	Expiration date of the service. Removes the service from the service selection list.
20	Day Start	Each service is a series of days within a week. This represents the starting day. (example: Monday)
	Day Stop	Represents the last day in the interval.
25	Time Start	Within a day, the service has a time period. This field represents the start of the period.
	Time Stop	Represents the end of the time period.
	Required Tape	If stored tapes are required, the number of tapes required by the service.

(3) Broadcast Program Management

30 Broadcast program management is one focal point of the data management system. The issues of product, price, promotion and packaging are addressed at this level.

2151458

5 Decisions in these areas will affect the actual programming that will be shown to the viewers. Information on description of the content of each program event, program scheduling, broadcast program pricing, TV/set top information flow and information on how broadcast programs will be mapped to viewer channels should be included in the database. Preferably, the EIS system described below will access this data and assist in the Broadcast Program Management.

10 (4) Internal Program Management

Information on internally stored programs at the Operations Center 202 should also be maintained. This will allow the Operations Center 202 to assemble electronically stored programs, CD stored programs and program tapes, and ensure the quality of programs and location of programs.

15 (5) Marketing And Customer Information

20 Last, and important, marketing and customer information should be maintained. In order to effectively manage the operations, information is constantly needed on market conditions. Information is needed on the existence of markets for certain programs. The following type of information must be maintained in a Marketing and Customer Information data base: demographic profile of viewers, viewer buy information; correlation of demographic information with buy information, information rapid restructuring of program mix in response to data analysis. As a subscriber uses the system, this viewer information or viewer log data can be stored and maintained in relational database. The Marketing Information Interface 402 gathers the marketing information and indexes the information for inclusion in the Marketing and Customer Information database. An example of the type of information that is needed in this data base is a viewer profile.

25

30

2151458

53

The viewer profile data fields are an example of typical fields required in the databases. Definitions of various fields are listed below. The primary purpose of profiling the viewer is to acquire marketing information on the viewer's response to available selections. Ancillary information will be available including the actual program and channel selections of the viewer. Information tracked within the viewer's profile includes:

10	Viewer ID	A unique identifier generated by the system.
	Set-Top Types	Boolean field which identifies the type of set top used.
	Headend ID	Links the viewer to a particular cable site.
15	Site Assigned ID	Viewer ID assigned by the cable site.
	Set-Top ID	ID of the viewer's set top.
	Hookup Date	Date physical hardware is connected.
20	Survey Date	A demographic profile will be conducted on each user. The following fields represent this demographic information. The data represents when the
25	Viewers Age 2-5	Boolean field if the household has viewers between 2 and 5 years of age.
30	Viewers Age 6-11	Boolean field if the household has viewers between 6 and 11 years of age.

2151458

	Viewers Age 12-17	Boolean field if the household has viewers between 12 and 17 years of age.
5	Tape Rental \$	Approximate amount spent on tape rentals on a monthly basis.
	PPV \$	Household average pay-pre-view expenditures per month.
	Income	Annual household income.
	Zip Code	Self-explanatory.
10	Cable Tier	Level of cable service purchased.
	Number of TV's	Self-Explanatory.
	Years with Cable	Self-Explanatory.
	Occupancy	Number of people in household.
15	Highest Education	Highest level of education of any member of the household.

20 The compilation of viewer demographic information has an impact on decisions based on marketing. The names of the heads of household are not used due to Privacy Act considerations. Completion of demographic data can be accomplished referencing the cable site assigned ID or the system generated ID. There are numerous variations to the field definitions listed above such as different age groupings.

25 To maintain the database at the Operations Center 202, a data base server, communications server, user work station or stations 262, or the suitable equivalent thereof, are needed. The database server performs the following functions: it is the repository for data base files, event logging, event scheduling (example, automated download of files to headends 208), multi-user services, data base server services, and data base security access.

30 The communications server performs the following functions on data base data: integrity check, filtering.

2151458

55

processing, downloading to headends 208, uploading from headends 208, and uploading from remote location.

5 User work stations 262 perform the following tasks: creation, deletion and access of all database data, system administration and report generation. Database manipulations are performed through the user workstations or remotely. The database structure is designed to support multiple users performing multiple tasks simultaneously. The preferred embodiment includes a network of user workstations 262. 10 The workstations 262, through user interface software, access data within database files on the database server.

For example, once the appropriate database data has been generated for downloading to a cable headend 208, the communications server is instructed to perform the 15 download. Although this may be done manually at the communications server, it is preferred that the communications server automatically send information to the cable headends 208. The communications server retrieves required data from the database server, filters out any data 20 not associated with the specified headend 208, and performs data integrity checks, creates data files to be downloaded and then downloads the data file via modem (or other means such as the DCPU 270). While the communication server is connected with the headend 208, it also requests any data 25 that the headend might be holding for the Operations Center 202. This may consist of cable headend 208 event log information, set top billing and viewer log data on programs watched, etc.

30 The communications server may also assist in retrieving information from other remote sites such as remote billing and statistic sites. For example, if a location is being used for billing purposes, the communications server may retrieve

2151458

viewer log data. Also, the communications server may retrieve billing and viewer log data from actual set top converters in the field. Once the data is retrieved it is sent to the database server. Thus, in the preferred embodiment the
5 communications server will support incoming information via modem or otherwise.

The basic database structure at the Operations Center 202 consists of multiple tables. Database data tables contain one or more data records, each with multiple fields. Each
10 field contains a piece of data about the particular record. This data may be general information, such as a numeric value, date or text string, or it may be a reference to another database record relating one piece of data to another. Database index files contain information about associated data
15 files to allow for improved data retrieval. The database index file makes retrieval of information much quicker.

In an alternative embodiment where some television programming begins with the procurement of source material in the form of tapes or CDs, additional data about the tapes or
20 CDs may be stored in the Operations Center database. Each tape or CD may have a database record associated with it, source tape data file. Each tape may contain multiple cuts of which each cut has an associated record in a source tape detailed data file. Additionally, a company data file may
25 contain individual records for the rights of the holders of the source tapes as well as company information about cable headends 208. In this alternative embodiment with tapes, programs may be created from multiple tapes using multiple tape source cuts. The programs created by these source cuts
30 may be stored and the individual cuts that make up the programs may be stored in a database record called "program tape detail." Events may be created that consist of more than

2151458

57

one program and details on individual programs that make up these events may be stored in a database file called "event detail." Using this embodiment, events may be sold to subscribers.

5 Figure 10 and the description below is a more complete example of a database structure that can be used with the present invention. Each database file is listed below along with a description, record field details and explanation of relationships. The software data structures are defined after
10 the description of the database structure.

 The SCHEDULE Database file 501 contains scheduling data for a single day. There are many schedule files, one for each day of schedule information. The actual filename for a given days schedule is assigned under computer control.
15 Schedules are broken up into single days so they may be easily created, dispatched and archived. A cross-reference of days to computer generated filenames is kept. Each scheduled event (either a program or a preview) has its own record entry and unique schedule ID. This record references the
20 corresponding scheduled program or preview and program type (either program or preview). The service to carry the scheduled program is also referenced. The starting date and time is also specified. Program duration is stored as a program attribute and is not included here. Note that
25 program, preview and service records must be provisioned before they may be referenced in a schedule record.

 Another SCHEDULE Database file 500 contains a cross-reference of starting dates data to computer generated filenames.

30 The PROGRAM Database file 502 contains Program records are contained in another database file 502, with each record representing a source program. Each program has a

unique program ID. If the program has a corresponding preview, it is also referenced. Program category and price are also referenced. The structure of the program category database may be modified if multiple categories per program are desired. Program name, description and duration are also given. Note that preview, program category and price category records must be provisioned before they may be referenced in a program record.

10 The SERVICE Database file 503 contains service records with each record representing an available service. A service may be thought of as a virtual video channel. Virtual channels are non-existent channels which are mapped or created by hardware and software and is described in co-
15 pending patent application Ser. No. PCT/US93/11606, entitled ADVANCED SET TOP TERMINAL FOR A CABLE TELEVISION DELIVERY SYSTEM, incorporated herein by reference. Services are then mapped into local headend channels. Since initial distribution of video source material may be by
20 "Federal Express" instead of a video channel, a service ID is used to identify the virtual channel being used for the desired service, "60 Minutes" could be distributed and then be mapped into any desired local headend channel. The service database exists at both the national site and at each
25 local headend 208. Every service has a name, call letters and a description of the service. Every service also has an assigned local channel, "A" tape (or CD) machine ID and "B" tape (or CD) machine ID. Note that these last three parameters only apply to the service databases at the local
30 headends 208. The local headend service database performs an equivalent function of a "channel map". For a further description of the cable headend function, see co-pending patent application Ser. No.

PCT/US93/11616, entitled NETWORK CONTROLLER FOR A CABLE TELEVISION DELIVERY SYSTEM, filed by the same assignee.

5 The PREVIEW Database file 504 contains preview records with each record representing a source preview. A preview is like a program that is scheduled and distributed over a service. It differs from a program in that multiple previews may be distributed over the same service at the same time. Also, previews are free. Each preview specifies
10 its location on the TV screen. This is generally done by selecting from a menu of valid screen positions. Unlike programs, previews do not reference program and price categories or other previews.

15 The PROGRAM CATEGORY Database file 505 contains program category records with each record representing a valid program category. Examples of program categories are movies, sports, educational and news. Multiple program categories per program may be accommodated if desired with simple changes to the database structure.

20 The PRICE CATEGORY Database file 506 contains price category records with each record representing a valid price category. Price categories are used to provide pricing consistency throughout the system. It also provides flexibility at the headend 208 to price various categories differently
25 should this be desired. For example, distributed movies may be assigned the price category "movie" at the national site. Each headend 208 could then charge differing amounts for their movies by manipulating their local price category database. If a current price structure needed to be changed,
30 the change would be made once in the price category database instead of in each program record.

AMENDED SHEET

2151458

60

The EVENT LOG Database file 510 contains event data for a single day. There are many event files, one for each day of event information. The actual filename for a given days events is assigned under computer control. Events are
5 broken up into single days so they may be easily archived. A cross-reference of days to computer generated filenames is kept.

Each event record contains a unique ID, an event code, ID of the process that generated the event and date/time
10 stamp of the event.

The EVENT LOG FILENAME Database file 507 contains a cross-reference of start date to computer generated filenames.

The VIEWER LOG Database file 512 contains viewer log
15 data for a single day. There are many viewer log files, one for each day of viewer log information. The actual filename for a given days viewer log data is assigned under computer control. Viewer log data is broken up into single days so it may be easily archived. A cross-reference of days to computer
20 generated filenames is kept.

Each event record contains a unique ID, an event code, ID of the process that generated the event and date/time stamp of the event. The Marketing Information Interface 402 accesses the VIEWER LOG Database file as necessary to
25 retrieve "program watched" information 420.

The VIEWER LOG FILENAME Database file 509 contains a cross-reference of date to computer generated filenames.

The BILLING Database file 511 contains billing data for a single day. There are many billing files, one for each day of
30 billing information. The actual filename for a given days billing data is assigned under computer control. Billing data is broken up into single days so it may be easily archived. A

cross-reference of days to computer generated filenames is kept.

Each event record contains a unique ID, an event code, ID of the process that generated the event and date/time stamp of the event.

The BILLING FILENAME Database file 508 contains a cross-reference of start date to computer generated filenames.

The NEWS FILENAME Database file 509 contains a cross-reference of date to computer generated filenames.

The SET TOP Database file 517 contains set top converter records with each record representing a unique set top converter. Each set top is assigned to a headend 208. Set-top type, software version and serial number is also stored. Note that headend records must be provisioned before they may be referenced in a set top record.

The HEAD END Database file 518 contains headend records with each record containing headend 208 data specific to a single headend 208. Each headend 208 has a name, contact name, address, phone number, modem information, time zone (relative to GMT) and daylight savings time flag. This information may be stored in a separate database file called Cable Franchise Configuration (shown as 328 in Figure 11).

The NATIONAL Database file 515 contains a single record containing national site information. This includes site name, contact, modem information, time zone and daylight savings time flag.

The CUSTOMER Database file 516 contains customer records with each record containing customer data specific to a single customer. This includes personal information

2151458

62

(name, address, phone number, . . .) and assigned set top converter.

5 The TAPE MACHINE Database file 519 contains video tape or CD machine information. Each machine is assigned a unique ID, its control port address, its A/B switch address (if present), its assigned service and an A/B assignment. This database is only located at the headends 208.

10 The MESSAGE Database file 514 contains available system messages. They are detailed in nature and are pre-programmed. Each message has an associated function. To schedule a desired function, the appropriate message is referenced in the scheduler task list.

15 The TASK Database file 513 contains scheduled tasks to be performed periodically. It is used in conjunction with a scheduler process to control computer system functions such as data dispatch and retrieval, archival and database maintenance. Each task is assigned a unique ID, start time, stop time, period in minutes) and task type (single, periodic, round-robin). Functions are actually scheduled by scheduling
20 the appropriate message to be sent to the appropriate process. Available messages are kept in a separate database. Note that these messages must be provisioned before they may be referenced in a task record.

E. System Operations

25 Figure 11 shows the basic operations that must occur in order for the packaged signal to be sent to the satellite 206. External digital 280 and analog signals 282 must be received from television programming sources and converted to a standard digital format by a converter 284, as described
30 above. Also within the Operations Center 202, stored programs 286 must be accessed using banks of looping tape machines or other video storage/retrieval devices, either

2151458

63

analog or digital, and converted to a standard digital format by the converter 284 prior to use by the CAP 260.

5 The programmer or program packager utilizing the CAP 260 must input a variety of information, including program information, in order to allow the CAP 260 to perform its function of generating program control information and packaging programs. Some of the information required by the CAP 260 are the date, time slots and program categories desired by the television programmer.

10 The CAP 260 system includes one or more CPUs and one or more programmer/packager consoles, together identified in Figure 4 as workstations 262. In the preferred embodiment, each packager console includes one or more CRT screens, a keyboard, a mouse (or cursor movement), and
15 standard video editing equipment. In large Operations Centers 202, multiple packager consoles 262 may be needed for the CAP 260.

As shown in Figure 12, the first step in the operation of the CAP 260 is selecting the type of programming 300 which
20 will be packaged. Basically there are six broad categories in which most television programming can be classified: static programming 302, interactive services 304, pay per view 306, live sports specials 308, mini pays 310, and data services 312. Static programs are programs which will show
25 repetitively over a period of time such as a day or week. Static programs include movies showing repetitively on movie channels, children's programs, documentaries, news, entertainment. Program services, with defined start and end time periods, behave like static programs and may be handled
30 in a similar manner.

Interactive services 304 typically include interactive programs using the Vertical Blanking Interval (VBI) or other

2151458

data streams synchronized with the programming to communicate interactive features (such as those used in education), and games. Using this feature, interactive home shopping programs are possible. Pay per view 306 are programs which are individually ordered by the subscriber. After ordering, the subscriber is authorized to access the program for a limited time, (e.g. three hours, two days, etc.). Live sports specials are live events usually related to sports which subscribers are unlikely to watch on taped delay.

Mini pays 310 are channels to which existing set top converter boxes (not shown) and the set top terminals 220 of the present invention may subscribe. The subscriptions for mini pays 310 may be daily, weekly, or monthly. An example would be the Science Fiction channel. Data services 312 are services in which information is interactively presented to the subscriber using a modem or other high rate of speed data transfer. Some examples are Prodigy, services for airline reservations, and TV guide services (e.g. TV Guide X*PRESS™, InSight™, etc.). Data could also include classified or other forms of advertising.

The packager begins the CAP processing using the Packager Data Entry Interface Software 400 and a workstation 262. After selecting the type of programming, the packager must identify a pool of programs (within a category) to be packaged. The next CAP step varies for different program categories. For the category of live sports 308, additional program interstitial elements 314 such as promos and other sports news may be added before further processing. For the live sports 308, static (or program service) 302, interactive services 304 and pay per view 306 categories, the next CAP 260 step is for one television program to be selected 316. This is followed by each program individually being assigned

2151458

65

dates to be played, a start date (for continuous play) and start times 318. Many dates and start times may be assigned to any given program. Using this methodology, programs may be purchased by viewers in time slices (e.g., one week). The program information for these categories may then be processed for allocation of transponder space and setting of prices, as indicated at blocks 320, 322, respectively.

Mini pays 310 and data services 312 require less processing by the CAP 260. After identifying the mini pays 310, the CAP 260 may proceed to allocation of transponder space and pricing, block 320, for the mini pays 310. Data services in the preferred embodiment generally do not require allocation of transponder space and generally do not require price setting. The information for data services 312 may be directly processed for menu configuration, block 324. In alternate embodiments, the data services 312 may be processed through these portions of the CAP 260 program.

The CAP 260 uses an interactive algorithm 416 to allocate transponder space 320 and set prices 322. The factors weighed by the algorithm are: 1. buy rates of the program, 2. margin of profit on the program, 3. length of the program, 4. any contractual requirement which overrides other factors (such as requirement to run a specific football game live in its entirety). The information on buy rates of the program may be obtained by the Marketing Information Interface 400 from a Central Statistical and Billing Site, a Regional Statistical and Billing Site, the cable headend 208 or directly from the set top terminals 220 as will be described later. The CAP 260 must consider the priority levels of programming (e.g., Figure 16) when allocating transponder space. Particularly, as in the preferred embodiment, transponders are assigned to three specific priority levels.

2151458

The CAP may automatically (without packager intervention) access the MII 400 and the EIS to obtain necessary decision making information on transponder allocation.

5 Following transponder allocation and price setting 320, 322, respectively, the CAP 260 proceeds to menu configuration 324. The positioning of programs within the menu configuration 324 can have an effect on subscriber buy rates for the program. (The processing of menu configurations 432 is also described in reference to Figure 8.)

10 Therefore, an algorithm accounting for either a manually assigned program importance or a calculated weight of the program importance is used to determine each programs position within the menu scheme. For instance, a popular program with a high profit margin may be assigned a high

15 weight of importance and shown in a prominent place in the menu scheme. Alternatively, a high profit program with sagging sales may be manually assigned a prominent place in the program schedule to increase sales.

20 After a series of entries by the programmer/packager at the Operations Center 202, the CAP 260 displays draft menus 434 or schedules (including priority levels) for programming. The packager may now manipulate the menus and schedules and make changes as necessary 436. After each change, the packager may again display the menus or schedules and

25 determine if any more changes are necessary 436. The packager may use the Executive Information System with yield management as described below to assist in editing the menus and schedules. When the packager is satisfied with the menu configuration 324 and scheduling of television

30 programs, the packager may then instruct the CAP 260 to complete the process.

2151458

67

After menu configuration 324, the CAP 260 may begin the process of generating a program control information signal 326 (see also Figure 8 software description at 442 and 404). In order to generate program control information signals 326 which are specific to a particular cable headend 208 system, the CAP 260 incorporates cable franchise configuration information 328. In the preferred embodiment, unique cable franchise configuration information 328 is stored at the Operations Center 202. The cable franchises upload changes to their specific franchise information 426 from time to time to the Operations Center 202 for storage 328. Preferably, a separate CPU (not shown) handles the management of the cable franchise information 328. From the stored cable franchise information 328, the CAP 260 generates a cable franchise control information signal 330 unique to each franchise.

Using the unique cable franchise control information signals 328 and the menu configuration 324 information, the CAP 260 generates the program control information signal 276, as shown at function block 326. The program control information that is unique to a particular cable franchise may be identified in various ways such as with a header. With the header identification, the cable headend 208 may extract the portions of the program control information signal 276 it needs. Now, the CAP 260 may complete its process by electronically packaging the programs into groupings 280 for the signal transmission and adding the program control information 276 to the packaged programs 334 to form a single signal for transmission. Through manual entries by the packager (PDEI 400) or by comparing against a list of programs, the CAP 260 will determine whether the programs

2151458

are arriving from external sources 280 or sources internal 286 to the Operations Center 202.

Referring back to Figure 11, upon completion of the CAP's functions, the Operations Center 202, or the uplink site 204 (Figure 1), compresses 288 (if necessary), multiplexes 290, modulates 292 and amplifies 294 the signal for satellite transmission 296. In a basic embodiment, the CAP 260 will also allow entry of time slots for local avails where no national programming will occur.

Figure 13 is a more detailed flow chart 340 of some of the functions performed by the CAP 260 after an initial program schedule has been entered and menu configurations generated. This flow chart highlights that some of the functions described earlier in reference to Figures 8, 9, 11 and 12 can be performed in parallel. The flow chart 340 shows six basic functions that are performed by the CAP 260: (1) editing program schedule for local availability 342 (only for non-standard services, i.e., those services that are not national cable services); (2) generating program control information signals 344; (3) processing external programs 346; (4) processing internal programs 348; (5) processing live feeds 350; and, (6) packaging of program information 352. In an alternate embodiment, the CAP 260 is capable of incorporating local programs and accommodating local availability for local television stations.

Following completion of the programming scheduling (accounting for local availability if necessary) and menu generation 342, the CAP 260 may perform three tasks simultaneously, generating program information signals 344, processing external programs 346 and processing internal programs 348.

The CAP 260 automatically identifies external programs feeds 356 and identifies which external feed to request the external program 358. The CAP 260 gathers and receives the external programming information 280, 282 (Figure 11) and converts it to a standard digital format 360 for use. The CAP 260 also identifies internal programs 362 (and defined program services), accesses the internal programs 364 (and program services), and converts them to a standard digital format 366, if necessary. In addition, the CAP 260 identifies live signal feeds 368 that will be necessary to complete the packaged programming signal 370. In its last task depicted in Figure 13 the CAP 260 completes the packaging of the programs and combines the packaged program signal with the program control information signal 352, amplifies the signal 354 and sends it out for further processing prior to uplink.

F. Allocation of Cable System Bandwidth

One of the primary tasks of the Operations Center 202 is, with assistance from the cable headends 208, effective utilization of available bandwidth from the Operations Center 202 to the subscriber homes. Figure 14 shows effective allocation of 750 MHz of bandwidth (1 MHz to 750 MHz) for television programming. In Figure 14, bandwidth is allocated for both analog 226 and digitally compressed 227 signals. In the preferred embodiment, the bandwidth is divided so that each category of programs receives a portion of the bandwidth. These categories correspond with major menus of the set top terminal software. The representative categories shown in Figure 14 include: (1) high definition TV (HDTV) made possible through the use of compression technology, (2) A La Carte Channel category which provides

2151458

specialty channels for subscription periods such as monthly, and (3) pay-per-view.

Figure 15 shows a chart 228 of compressed channel allocation for a variety of programming categories 229 that have been found to be desirable to subscribers. By grouping similar shows or a series of shows into blocks of channels 230, the system 200 is able to more conveniently display similar programming with on-screen television menus. For example, in the movie category, which has the greatest allocation of channels, the same movie may be shown continuously and simultaneously on different channels. Each channel starts the movie at a different time allowing the subscriber to choose a more suitable movie starting time (e.g., every 15 minutes).

In order to accommodate cable TV systems that have different bandwidths and channel capacities, the television programming and television program control information may be divided into parts such as priority one, two and three. The large bandwidth cable TV systems can accommodate all the parts of the television programming and all parts of the television programming control information. Those cable TV systems with a more limited bandwidth are able to use the program delivery system 200 by only accepting the number of parts that the cable system can handle within its bandwidth.

For instance, as is shown in Figure 16, three cable television systems with different bandwidths may use the program delivery system 200 simultaneously with each system accepting only those parts of the information sent which it is capable of handling. Priority one television programming and menus 240 are accepted by all three systems. Priority two television programming and menus 242 are not accepted by the cable television system whose

capacity is the smallest or in this case 330 MHz (40 channels) system. Priority two television programming and menus 242 are accepted and used by the two larger capacity cable television systems shown. Priority three television programming and menus 244 are only used by the largest capacity television system which is capable of handling all three parts -- Priority one, two and three programming and menu information.

With this division of television programming and menus, the program delivery system 200 may be utilized simultaneously by a variety of concatenated cable systems 210 (depicted in Figure 1) with varying system capacities. By placing the heavily watched or more profitable programming and menus in the priority one division 240, both users and owners of the cable TV systems will be accommodated as best as possible within the limited bandwidth.

Figure 17 shows three different cable headend 208 systems, each system receiving the entire satellite signal from the Operations Center 202 and stripping those parts of the signal which cannot be handled by the local cable system due to bandwidth limitations. In this particular embodiment, the three local cable television systems shown have bandwidth limitations which correspond with the bandwidth limitations depicted in the previous Figure 16. As the bandwidth decreases, the programming options available to the viewer in the exemplary on-screen menu decreases. Using this preferred embodiment, the Operations Center 202 is able to send one identical signal to the satellite 206 that is sent to all the cable headends 208. Each cable headend 208 accepts the entire signal and customizes the signal for the local cable system by stripping those portions of the Operations Center signal that are unable to be handled by the local cable system.

2151458

An alternate embodiment (not shown) requires the Operations Center 202 (and uplink sites 204) to send different signals for reception by different capacity cable headends 208.

5 There are several ways in which a cable headend 208 may strip the unnecessary signal from the Operations Center 202. A person skilled in the art will derive many methods from the three examples discussed below. The first method is for the signal originating from the Operations Center 202
10 (and uplink site 204) to be sent in portions with each portion having a separate header. The respective cable headend 208 would then recognize the headers and transmit to the concatenated cable system 210 only those signals in which the proper headers are identified. For example, using three
15 concatenated cable systems shown in Figure 17, the headers may be "001," "002," and "003." A wide bandwidth concatenated cable system can accept program signals with all three headers, while the narrowest bandwidth concatenated cable system may only be able to accept signals
20 with a "001" header. For this first method, a central Operations Center 202 must divide the program signal into three parts and send a separate leading header before each signal for each part. This method requires has the additional signal overhead of a header on the program signal. The
25 header would be transmitted from time to time as necessary.

A second method requires a set of transponders to be assigned to each priority level and the cable headend 208 to route signals from the transponders corresponding to the proper priority level for the concatenated cable system 210.
30 For example, if there are three priority levels and eighteen transponders, transponders one through nine may be assigned to priority level one, transponders ten through

fourteen priority level two, and transponders fifteen through
eighteen assigned to priority level three. Thus, a
concatenated cable system 210 capable of operating only at
priority level two, would only receive signals from
5 transponders one through nine, and ten through fourteen
from the respective cable headend 208. The program signal
from transponders fifteen through eighteen would not be
transmitted to the priority level two concatenated cable
system. This method requires the Operations Center 202 to
10 properly assign programs to transponders by priority level.
This can be accomplished by the CAP using the software
described earlier (e.g., Figure 8 at 438 and 440).

The third and the preferred method is for the cable
headend 208 to pick and choose programming from each
15 transponder and create a customized priority one, two, and
three signal with chosen television programming. The cable
headend 208 would then route the appropriate customized
signal to each part of the concatenated cable system 210 that
the cable headend 208 serves. This third method requires
20 that the cable headend 208 have a component, such as the
combiner (described in greater detail in a co-pending U.S.
Patent Application entitled Digital Cable Headend For A Cable
Television Delivery System, Ser. No. PCT/US93/11615, filed
Dec. 2, 1993, owned by the assignee of the present
25 application) which can select among programs prior to
combining the signal for further transmission on a
concatenated cable system 210. The third method requires
the least coordination between Operations Center 202 and
the cable headend 208.

30 In addition to dividing the television programming and
menus into parts, the Operations Center 202 of the preferred
embodiment is also capable of dynamically changing the

2151458

bandwidth allocation for a particular category of programming. Figure 18 depicts this dynamic change in bandwidth allocation from a typical week day prime time signal 250 to a Saturday afternoon in October signal 252 (during the college football season). Figure 18 highlights the fact that the bandwidth allocated to sports is limited to eight selections 251 during week day prime time 250 but is increased to sixteen selections 253 during a Saturday afternoon in October 252. This dynamic increase in bandwidth allocation allows the system to accommodate changes in programming occurring on an hourly, daily, weekly, monthly, seasonal and annual basis.

In addition to dynamically allocating bandwidth for programming categories, the Operations Center 202 can also dynamically change the menu capacities in order to accommodate the change in programming and bandwidth. For example, on a Saturday afternoon in October 252, the major menu for sports may include a separate subcategory for college football. This subcategory would, in turn, have a separate submenu with a listing of four, six, eight, or more college football games available for viewing. In order to accommodate this dynamic menu change, the Operations Center 202 must add a submenu listing to the major sports menu, create a new or temporary submenu for college football, and allocate the necessary menu space on the college football submenu.

Once the television programs have been packaged and a program control information signal is generated to describe the various categories and programs available, the packaged programs are then digitized, compressed, and combined with the program control information signal. Upon the signal's departure from the Operations Center 202 the breakdown

2151458

75

into categories is insignificant and the signal is treated like any other digitally compressed signal

G. Compressing and Transmitting Program Signals

5 After packaging, the packaged television program signal is prepared for satellite transmission and sent from the Operations Center 202 to the cable headend 208 via satellite 206. Depending on the specific embodiment, the television program signal may need to be compressed, combined/multiplexed, encoded, mapped, modulated, 10 upconverted and amplified. This system, which is intended to be compatible with existing C and Ku Band satellite transmission technologies, accepts video, audio and data signals ranging in signal quality, and input from a number of sources.

15 As shown in Figure 3, in the preferred embodiment, the packaged program signal will be treated at a master control uplink site 211 prior to being transmitted to the satellite 206. Following compression the channels must be multiplexed for each transponder carrier and sent to the 20 satellite 206 dish that will provide the uplink. A variety of multiplexing schemes may be used in the system. In some situations, it may be advantageous to use different multiplexing schemes in different parts of the overall system. In other words, one multiplexing scheme may be used for 25 satellite transmission 206 and a second remultiplexing scheme for the land transmission. Various satellite multi-accessing schemes and architectures can be used with the system, including both single channel per carrier (SCPC) frequency division multiplex (FDM) and multiple channel per 30 carrier (MCPC) time division multiplexing (TDM). Time division multiplexing is the more desirable scheme. Once the signal has arrived at the uplink or master control site

2151458

76

211, it must be modulated, upconverted, and amplified. Various types of satellites and transponders capable of handling digital signals may be used in this cable television packaging and delivery system. One of the achievements of the present invention is effective utilization of digital compression technology by packaging television programs into categories that allow easy access to television programs by consumers. With current digital compression techniques for video, the typical 50-channel capacity cable satellite receiving system can be increased to 300 channels.

Presently, one transponder is used for each satellite delivered channel. The preferred embodiment uses 18 satellite transponders and compression ratios of 4:1 to 8:1 to achieve a capacity of 136 satellite delivered channels. More transponders or higher compression ratios can be used to deliver up to the channel capacity of any existing cable system.

An example of a satellite that may be used is the AT&T Telstar 303. The signal is transmitted from the satellite to the cable headend where a computer system including a digital switch treats the signal and delivers it through cables to a subscriber's home. In alternate embodiments, multiple Operations Center and multiple uplink sites can be simultaneously utilized.

H. Cable System Use of Control Signal

Figures 19 through 21 depict sample menu screens produced by the set top terminal using the program control information signal 276. Figure 19 shows a menu which enables the viewer to select a program category or program service from among a choice of eight program categories. Figure 20 shows a menu for the viewer to select a hit movie from among ten hit movies. Figure 21 provides

2151458

77

information about a movie (or event) and enables a viewer to order the movie for viewing.

Figure 19 through 21 show text generation by the set top terminal 220. This text is generated using information received via the program control information signal. Figure 20 shows the text 380 generated for the hit movies major menu. In the preferred embodiment, text 380 such as that shown in Figures 19 through 21 is generated separately by a text generator (not shown) in the set top terminal unit 220. Those portions of the text that generally remain unchanged for a period of weeks or months may be stored in EEPROM or other local storage. For example, the text "HIT MOVIES from" 382 will consistently appear on each hit movies' major menu. This text may be stored on EEPROM or other local storage. Further, text such as that which appears at the lower center part of the screen "PRESS HERE TO RETURN TO CABLE TV" 384 appears many times throughout the menu sequence. This text may also be stored locally at the set top terminal 220. Text which changes on a regular basis, such as the movie titles (or other program selections), will be transmitted to the set top terminal 220 by either the operations center 202 or the cable headend 208. In this manner, the cable headend 208 may change the program selections available on any major menu modifying the program control information signal sent by the operations center 202 and transmitting the change. The network controller 214 of the cable headend 208 generally modifies the program control information signal and transmits the set top terminal control information signal (STTCIS). It is preferred that the text 380 is generated by the set top terminal 220 separately from the graphics because the text can be stored locally in a more compact manner requiring less storage space at the set

top terminal 220. In addition, it allows for easy communication of text changes from the operations center 202 or cable headend 208 to the set top terminal 220.

5 Figures 19 through 21 show the use of day, date and
time 386 information on menus. This information may be
obtained in a variety of ways. The day, date, and time
information 386 may be sent from the operations center 202,
the cable headend 208 (signal processor or network
10 controller 214), the uplink site, or generated by the set top
terminal unit 220 internally. Each manner of generating the
day, date, and time information 386 has advantages and
disadvantages which may change given the particular
embodiment and costs. In the preferred embodiment, the
day, date, and time 386 are generated at a central location
15 such as the operations center 202 and are adjusted for
regional changes in time at the cable headend 208.

In order for the set top terminal 220 to generate
submenus for subcategories of categories shown in Figure 19
(which relate to the content of the programs), and to
20 generate menus for movies such as Figure 21, the terminal
must receive information on the content of the programs
from the Operations Center 202 (via the cable headend 208).
Normally the set top terminal 220 would receive this
information in the form of the program control information
25 signal (or STTCIS). As shown figure 21, in addition to the
text needed for these program menus, video or program
scenes are also necessary.

Live video signals may be used in windows of certain
menus such as Figure 21. These video signals can be sent via
30 the program control information signal, STTCIS, or can be
taken off channels being transmitted simultaneously with the
menu display. If the video signal is taken off a channel, less

2151458

79

information needs to be sent via the program control information signal. However, this technique requires that separate decompression hardware be used for the program control information and the channel carrying the video.

5 Separate decompressors for the video signals and program information signal allows for the greatest flexibility in the system and is therefore the preferred embodiment. A separate decompressor also assists in assuring that the switch from menus to television programming is smooth and without

10 any significant time delay.

Live video for menus, promos or demos may be sent to the set top terminal 220 in several ways: a) on a dedicated channel, b) on a regular program channel and scaled to size, c) sent along with the program control information signal,

15 etc. However, in the preferred embodiment, a great deal of short promos or demo video are sent using a split screen technique on a dedicated channel.

Using a split screen technique, any number of different video clips may be sent (e.g., 2, 4, 6, or 8 video clips). To

20 show the video clip on a menu, the video must either be scaled and redirected to a video window on a menu screen or a masking methodology can be used. Masking involves playing the entire channel of video (all 2, 4, 6, or 8 split screens) in background and masking the unwanted video clip portions of

25 the split screen by playing the menu in foreground and overlaying the unwanted background video. Masking is the least expensive method because it does not require any special hardware and it increases video throughput to the set top terminal 220. However, using the masking technique

30 without any video redirecting causes each video clip to be located in a different position on the screen. It also requires the masking to be different for each video clip and makes

2151458

80

consistent format difficult. On the other hand, scaling and redirecting video is generally difficult, expensive and requires additional hardware.

5 In order for the Operations Center 202 to prepare the promo video signal to be sent to the set top terminal 220, the Operations Center 202 must first identify the duration and actual video cut to be used for each promo and its position within the promo video signal. This information is maintained within the Operations Center 202 database. When
10 it is time to produce the promo video signal (either to tape or to broadcast), each promo cut is scaled, positioned and combined with the other promos to form the single promo video signal. This is performed by readily available commercial equipment. Each promo is run repeatedly while
15 the promo video signal is being generated. The audio signals of the individual promo cuts may be combined into the promo video signal audio tracks based upon the number of audio tracks available. The mapping of the audio tracks to the promos is also stored in the Operations Center database.
20 Additionally, the mapping of promos to the programs that they are previewing is also stored in the Operations Center database. All promo database data is made available to the set top terminal 220 through the STTCIS.

25 In the preferred embodiment, the Operations Center 202 transmits six video/graphic promos for advertising purposes all on one channel. The throughput of the video/graphics on a single channel can be increased through the use of digital compression techniques. The set top terminal 220 uses either video scaling and redirecting
30 techniques or masking to utilize the six video scenes. Although the set top terminal 220 actually performs the manipulation of video as necessary to generate the "live"

2151458

81

menus for the subscriber, the appropriately prepared video signals must be formed and sent by the Operations Center 202 to the set top terminal 220.

5 If a promo for a given program is available at the set top terminal 220, the viewer may command the set top terminal 220 to display the promo. Generally, this is done through program selection from a menu screen by the subscriber. The selected program is referenced to information about available promos and allows the set top terminal 220 to tune
10 to the proper channel, select the appropriate menu overlay mask based on the promos position and switch on the audio track(s) if they are available. The promos position on the screen dictates the displaying of the "live" text (refer to the video window of Figure 21). The program associated with the
15 currently selected promo may be purchased from this menu screen. Events, services and slices of time may be purchased from promotional menus.

Management of promo video signals at the Operations Center 202 is similar to that of other programs except that
20 more information is needed in order to specify the details of the promo video signal. The broadcasting of the promo video signal is identical to the broadcasting of a video program.

In order to limit the amount of bandwidth needed to transmit the program control information signal, various
25 compression techniques employed for non-video may be used such as block coding, contour coding, blob encoding, and run-length encoding. Further, the program control information signal may be divided into text and graphics, or video, text and graphics and then recombined at the set top terminal
30 220 using a text generator, graphics decompression, and video decompression as necessary.

2151458

As shown in Figure 2, an analog cable TV system 205 can continue to exist alongside and within the digitally compressed system of the present invention. The digital transmissions do not effect the analog system. In fact, the analog cable signal may be transmitted simultaneously on the same cable as the digital signal. Cable headends 208 may continue to supply subscribers with local channels in an analog signal format.

In the preferred embodiment, the Operations Center 202 and uplink 204 (Figure 1) or master control site 211 (Figure 3) are collocated. However, the Operations Center 202 and uplink site 204 may be located in different geographical places. Also, functions and equipment within the Operations Center 202 may be remotely located. For instance, the program storage may be at a different site and the programs may be sent to the CAP 260 via landline.

Alternate embodiments of the system 200 of the present invention may use multiple Operations Centers described above. In such an embodiment, it is preferred that one Operations Center be designated the Master Operations Center and all other Operations Centers be Slave Operations Centers. The Master Operations Center performs the functions of managing and coordinating the Slave Operations Centers. Depending on the method in which the Slave Operations Centers share functions, the Master Operations Center coordination function may involve synchronization of simultaneous transmissions from multiple Slave Operations Centers. To perform its functions, the Master Operations Center may include a system clock for synchronization.

An efficient method of dividing tasks among multiple Operations Centers is to assign specific satellite transponders

2151458

83

to each Operations Center 202 and to assign external program sources to the nearest Operations Center 202. Of course, this division of resources may not always be possible. Since programming will be grouped into priority levels with each priority level likely to be assigned specific satellite transponders, it is also possible to assign each Operations Center 202 to a priority level. For example, in a three priority level system with two Slave Operations Centers A and B and 18 transponders, the Master Operations Center may be assigned priority level 1 and assigned 9 transponders. Slave Operations Center A may be assigned priority level 2 and 5 transponders, while Slave Operations Center B is assigned priority level 3 and 4 transponders. In a multiple Operations Center configuration dynamic bandwidth allocation and dynamic menu capacity allocation becomes more complex and will be coordinated by the Master Operations Center.

Just as in the alternate embodiment wherein multiple Operations Centers 202 are used, a delivery system may have multiple satellite uplinks. Preferably, each Operations Center 202 has one or more uplink sites. Each Operations Center 202 controls the functions of its assigned uplink sites and may assign one site as a master uplink site.

In another alternative configuration, in regions or areas without cable services, where subscribers might use backyard satellite systems (TV RO) to receive packaged television services, the set top terminal 220 will include the appropriate hardware to allow connection to the backyard satellite reception equipment, i.e., a typical communication port. In this configuration, the backyard satellite system will receive programming signals originating from the Operations Center 202 directly from the satellite transponders. No cable headend 208 is utilized with a backyard satellite system. The

2151458

84

menu system within the set top terminal 220 will be programmed directly from the Operations Center 202. The Operations Center program signals and control signals arrive at the set top terminal 220 essentially unchanged.

5 Additionally, in this configuration, an upstream communication mechanism must be in place at the subscriber's home (e.g., modem) to communicate information to the Operations Center 202 such as program ordering information. The set top terminals 220 can be equipped with

10 a modem port for this upstream communication to the Operations Center 202. The two alternative embodiments described in the preceding four paragraphs, and other such embodiments not specifically referred to herein but within the understanding of those skilled in the art, incorporate or

15 combine one or more of the components of the system 200 of the present invention.

Although the present invention has been shown and described with respect to preferred embodiments, various changes and modification that are obvious to a person skilled

20 in the art to which the invention pertains are deemed to lie within the spirit and scope of the invention as defined by the following claims.

What is claimed is:

1. An apparatus for a television program delivery system characterized by:
 - receiving means (272) for receiving television programs in analog or digital format, each having video and audio components, wherein the receiving means (272) includes at least one reception port;
 - 5 coordinating means, connected to the receiving means (272), for coordinating the receipt of the television programs;
 - input means (262) for receiving input commands and specific information about each of the television programs;
 - 10 database means (268), including a central processing unit (264), connected to the input means (262), for storing and supplying information about the television programs;
 - generation means (264), connected to the input means (262) and database means (268), for generating a program control information signal (276) based on the input from the input means (262) and the database means (268), the signal (276) containing specific identification about each television program in a subset of television programs received by the receiving means (272), including the date and time of display and the category into which the television program falls;
 - 15 combining means (270), connected to the generation means (264) and receiving means (272), for combining the subset of television programs identified in the program control information signal (276) in preparation for transmission;
 - 20 multiplexing means (290), including a multiplexer, connected to the combining means (270), for multiplexing the combined television programs and program control information signal (276) for transmission; and
 - 25 transmitting means (292, 294, 296), including a modulator, connected to the multiplexing means (290), for simultaneously transmitting the multiplexed program control information signal (276) along with the multiplexed television programs so that video displays can
 - 30

be generated from the program control information signal and so that the downstream displays of the television programs can be selected and controlled by the viewers.

- 5 2. The apparatus of claim 1 further characterized by a conversion means (284), connected to the receiving means (272), for digitizing the television programs received in analog format.
- 10 3. The apparatus of claim 1 wherein the database means (268) further includes means for storing and for supplying information about the viewers.
- 15 4. The apparatus of claim 1 wherein the generation means (264) includes means for designating a set of television programs whose identities will be included in the program control information signal (276) so that the subset of television programs corresponds to one or more television program line-ups.
- 20 5. The apparatus of claim 1 wherein the input means (262) includes a local sensor and receptor which responds to voice, touch sensitive entries or input keys.
- 25 6. The apparatus of claim 1 wherein at least one of the television programs includes a television program which is continuously and repeatedly transmitted and wherein the program control information signal (276) continuously transmits the next incremental start time.
- 30 7. The apparatus of claim 1 wherein the central processing unit (264) combines and analyzes information from the database means and input entered from the input means (262) to generate the digital program control data information signal (276).
8. The apparatus of claim 1 wherein the apparatus is further characterized by internal video storage (267) of television programs in analog or digital format

and means for acquiring external feeds of television programming, both of which are accessible by and connected to the receiving means (272) whereby either internally stored programming or externally obtained programming can be converted by the converting means (284), combined by the combining means (270) and transmitted by the transmitting means (292, 294, 296) along with a related program control information signal (276).

9. The apparatus of claim 1 wherein the central processor unit (264) includes processing means for controlling the content of the program control information signal combined with software operating the processing means based on commands entered into input means (262), the combined processing means and software characterized by:

means (262, 264) for creating program lineups for transmission to viewers;

means (264, 268), connected to the creating means (262, 264) for prioritizing programs based on a plurality of factors including popularity of the program, its weighted importance and the bandwidth available to the viewer to receive the plurality of programs;

means (262), connected to the prioritizing means, for initiating allocation of different menus to different classes of viewers;

means (262), connected to the menu means, for initiating bandwidth allocations so that different program content is sent to different viewers; and

editing means (262), connected to the menu means, to design, create and change menus listing the variable content created by the prioritizing means and the allocation means.

10. The apparatus of claim 1 wherein the program control data information signal includes a category designation for each television program, each category designation selected from the group consisting of static programming, interactive services, pay for view, live sport specials, mini pays or data services.

11. The apparatus of claim 1 wherein the transmitting means (292, 294, 296) includes means for transmitting the signal to a plurality of selectable satellite transponders and wherein the apparatus is further characterized by means for
5 grouping television programs into separate groups for transmission over selected transponders.

12. The apparatus of claim 1 wherein the transmitting means (292, 294, 296) includes means for transmitting the signal to a plurality of selectable satellites and
10 the apparatus is further characterized by means for grouping television programs into separate groups for transmission to different geographical regions.

13. The apparatus as claimed in claim 1 wherein the database means (268) includes a plurality of databases and wherein the apparatus is further
15 characterized by processing means for accessing the databases and processing the information therein to provide the requisite program control information signal, the databases including information concerning each scheduled Program, records representing the source from which each television program was obtained, optional display services available, available previews of television programs,
20 program categories for each television program to be transmitted and price categories for each television program to be transmitted.

14. The apparatus as claimed in claim 1 wherein the database means (268) includes a plurality of databases, each database composed of multiple related sets
25 of data, and wherein the apparatus is further characterized by processing means for accessing the databases and processing the information therein and management means for determining how to operate the apparatus so that it provides the requisite control information signal, the databases including:

30 means for storing information about each destination to which the apparatus transmits;

means for storing information about rights in or ownership in each program source;

means for storing information about price, promotion and packaging of each program broadcast;

5 means for storing information about the storage location of each internally stored program; and

means for storing information about marketing and customer.

15. The apparatus of claim 1 modified in that:

10 the apparatus is further characterized by an internal collection means, connected to the receiving means (272), for gathering television programs from internal sources and feeding the television programs from internal sources to the reception port;

15 the generation means (264) and the input means (262) are part of a packaging means for creating program control information and for packaging television programs using the program control information, the packaging means including:

the central processing unit (264);

20 the input means (262) which includes an interface, connected to the central processing unit (264), to enable the program packager to enter program line-up information, wherein the interface is operably connected to the central processing unit (264);

25 a storage means, connected to the central processing unit (264), for storing the entered program line-up information;

logic means (264), connected to the central processing unit (264), for arranging the stored program line-up information and for creating program control information; and

30 means (264), connected to the logic means (264), for generating a program control information signal (276) from the program control information;

the combining means (270) combines the set of television programs identified in the program control information signal (276) with the program control information signal(276) to create a combined signal, wherein the combining means includes a delivery control processor (270);

5 the multiplexing means (290) multiplexes the combined signal;
and

 the transmission means (292, 294, 296), transmits the combined signal.

10 16. The apparatus of claim 15, wherein
 the packaging means includes means for generating menu configurations (324); and
 the packaging means generates the program control information using the menu configurations.

15 17. The apparatus of claim 15 further characterized by:
 means (264) for receiving unique cable franchise control information from cable franchises;
 means (269, 328), connected to the receiving means (264), for
20 storing the unique cable franchise control information, the storing means includes the cable franchise configuration database (328); and
 wherein the generating means (264), connected to the storing means (328) comprises means for including the unique cable franchise control information signal in the generated program control information
25 signal.

18. A method for delivering televisions programs in a television program delivery system characterized by the steps of:
 (a) receiving (272) a plurality of television programs in analog or
30 digital format, each having video and audio components;

(b) supplying (262) information about the received television programs, including information on the identities of the received television programs;

5 (c) storing (268) information supplied about the received television programs for use in the steps of delivering the received television programs;

(d) creating (400, 316, 318, 342) a plurality of program line-ups that identify received television programs using the stored information about the received television programs;

10 (e) generating (326, 442) a program control information signal (276) using one or more of the created program line-ups;

(f) preparing (332, 334) the program control information signal (276) and a plurality of the television programs identified in the program control information signal for transmission; and

15 (g) transmitting (292, 294, 296) the prepared program control information signal (276) and the prepared television programs for redistribution to subscriber locations, whereby, the prepared and transmitted television programs may be viewed by a subscriber.

19. The method of claim 18 wherein the preparing step includes a method of
20 transmitting a plurality of programs to a cable headend (208), each of the plurality of programs corresponding to one of a plurality of genre categories, the transmitting including the steps of:

25 prioritizing (400) each of the programs by assigning to each of the programs one of a plurality of priority levels, the plurality of priority levels including a high priority level and progressively lower priority levels;

forming (400) a plurality of signals, each of the signals including programs corresponding to a single priority level;

30 appending (320) a header to each of the signals, wherein the header identifies the priority level for a corresponding signal, thereby enabling recognition by the cable headend; and

transmitting (292, 294, 296) each of the headers and the corresponding signals to the cable headend (208).

20. The method of claim 18, wherein the preparing step includes a method of transmitting programs to a plurality of transponders, the method including the steps of:

5 prioritizing (400) each of the programs by assigning to each of the programs one of a plurality of priority levels, the plurality of priority levels including a high priority level and progressively lower priority levels;

10 forming (400) a plurality of signals, each of the signals including programs corresponding to a single priority level; and

transmitting (292, 294, 296) the plurality of signals to the plurality of transponders so that none of the transponders receives more than one of the signals.

21. The method of claim 20 further including the step of dynamically changing bandwidth allocation for at least one of the plurality of categories.

20 22. The method of claim 18 wherein the preparing step includes a method of transmitting a plurality of programs in a first amount of bandwidth for reception by a first cable headend (208), and in a second amount of bandwidth which is less than the first amount of bandwidth for a second cable headend (208), the method including the steps of:

25 prioritizing (400) each of the programs by assigning to each of the programs one of a plurality of priority levels, the plurality of priority levels including a high priority level and progressively lower priority levels;

30 dividing (320) the first amount of bandwidth so that each program category receives a portion of the first amount of bandwidth;

forming (320) a first allocation of bandwidth by allocating the first amount of bandwidth to high priority programs in each category;

continuing the forming (400) a first allocation step with the progressively lower priority levels until at least one of the following conditions occurs:

all programs are allocated;

all of the first amount of bandwidth is allocated;

dividing the second amount of bandwidth so that each program category receives a portion of the second amount of bandwidth;

forming (320) a second allocation of bandwidth by allocating the second amount of bandwidth to high priority programs in each category;

continuing the forming a second allocation step with the progressively lower priority levels until at least one of the following conditions occurs:

all programs are allocated;

all of the second amount of bandwidth is allocated;

transmitting the first allocation of bandwidth to the first cable headend (208); and

transmitting the second allocation of bandwidth to the second cable headend (208).

23. The method of claim 18 wherein the step of generating a program control information signal (276) for use by viewers using menus of available programming based on program line-up information includes the steps of:

obtaining and storing (400) program line-up information for each program, the program line-up information comprising, program name, program start time, program duration, program category and program price;

arranging (432) the program line-up information for all programs in a menu configuration;

creating (430) program control information using the program line-up information;

generating (442) a digital program control information data signal using the program control information; and

5 continuously transmitting (292, 294, 296) the digital program control information data signal simultaneously with the programs.

24. The method of claim 18 wherein the step of generating a program control information signal includes generating a program control information signal for
10 transmission to viewers of a simultaneously transmitted plurality of television programs so that variable video displays of current and future programming can be generated and so that the downstream displays of the television programs can be selected and controlled by the viewers, the method including:

receiving (400) as input data entry, program names, start times
15 (412), program duration and program category (302, 304, 306, 308, 310, 312) and price (414);

combining (402) the input data with stored marketing data (420, 422) including the frequency with which programs are watched by viewers and the demographics of viewers;

20 weighing (424) the data according to algorithms which assign a weight of importance to each type of data;

generating (430, 432) from the data a program line-up, and program position on menu formats;

displaying (434) the resulting draft menu for editing;

25 editing (436, 400) the menu; and

processing (438) the edited menu to generate (442) the program control information signal for transmission to viewers.

25. The method of claim 24 wherein digital program control information
30 signal is transmitted to cable franchises and wherein the method further includes:

means (404) for receiving specific information relating to each cable franchise that receives the signal; and

means (404) for creating a customized signal (428) for each cable franchise.

5

26. The method of claim 24 wherein the program control information signal also contains information for identifying virtual channels for interactive services (304) and data services (312) available to viewers using service information (503), the method further including the steps of:

10 collecting service information (503) on the data services (312) available; inventorying the interactive services (304) to be made available to the viewer;

assigning a virtual channel for the data services (312) and the interactive services (304);

15 determining method of upstream transmissions for interactive services (304); and

creating a menu for interactive services (304) and data services (312) for later processing.

20 27. The method of claim 18 wherein the step of creating a program line-up includes a method to assist a program packager to create a transmissible data information signal which organizes stored information on television programs available for viewing into program line-ups and generates (442) a program control information signal (276) from the program line-ups to enable selection of television programs for viewing by viewers, the method including the steps of:

25 receiving (400) information on television programs available for viewing; organizing (430) the information on television programs available for viewing into program line-up information using stored computer instructions including a set of computer instructions for utilizing the stored data to optimize the selection of television programs to be watched by each viewer;

30

editing (436) the program line-up information;

generating (442) the program control information signal (276) using the program line-up information; and

transmitting (292, 294, 296) the program control information signal (276) as a digital data signal so that the television programs from which a viewer can
5 choose will be displayed for selection by a viewer.

28. The method of claim 27 further including the steps of gathering of program watched information from viewers, and wherein the organizing step further includes:

10 targeting (402) a television program; and

managing (402) the yield of the programs watched information for the targeted program so that the targeted program yields higher programs watched information.

15 29. The method of claim 27 wherein at least one of the television programs is a program service including a time limited series of programming offered for a defined time each day for a limited number of calendar days and wherein the program control information signal (276) includes information providing an identification and description of the service, the starting and stopping dates and
20 the times each day that the service can be viewed by the viewers.

30. The method of claim 18 wherein the step of creating a program line-up includes a method to create program services containing at least one program and an interstitial audio/video for transmission, the method, including the following
25 steps:

obtaining (461) one or more programs and interstitial audio/video;

creating (460) events including:

30 combining (462) one or more programs with one or more interstitial audio/video so that an event is longer than the one or more combined programs; and

creating (464) an event identification for recalling the event;

generating program services including:

integrating one or more events using the event identification so that there are no disruptions to the programs or interstitial audio/video;

5 determining (318) calendar days that the program service will be transmitted;

defining (400) time of day that the program service will be transmitted; and

transmitting (292, 294, 296) the program service containing the integrated events on the determined calendar days at the defined time.

10

31. The method of claim 30 wherein program services are paid for by viewers, the method further including the steps of:

creating a mini-pay consisting of one or more program services; and
assigning a price to the mini-pay.

15

32. The method of claim 18 characterized in that the step of creating a program line-up includes a method for creating near video on demand service using programs wherein the near video on demand service is transmitted from a central location for distribution to subscribers, including:

20 designating (400) a program to be available to subscribers more than once during a day;

evaluating (400) the length of the designated program;

creating (400) program start times using the evaluated length of the program;

25 organizing (430) a program line-up with the designated program and the program start times so that the program appears in the program line-up more than once and wherein more than one designated programs is in the program line-up; and

30 wherein the step of generating (442) a program control information signal (276) uses the organized program line-ups.

33. The method of claim 32 wherein programs may be demanded within fifteen minutes, the step of creating program start times includes:

dividing the evaluated program length into multiple fifteen minutes segments and one last segment; and

5 identifying interstitial audio/video to be added to the last segment.

34. The method of claim 32 wherein a monitor is used, the method further characterized by:

10 graphically (438) reorganizing the program line up using a monitor before generating the program control information signal.

35. The method of claim 18 characterized in that the step of creating a program line-up includes a method for creating near video on demand service using programs wherein the near video on demand service is transmitted from a central location for distribution to subscribers, including:

15 designating (400) a program to be available to subscribers more than once;

evaluating (400) the length of the designated program;

20 creating (400) program start times using the evaluated length of the program;

organizing (430) a program line-up using the program start times (412) so that the program appears in the program line-up more than once;

generating (434) a program control information signal using the organized program line-up; and

25 transmitting (292, 294, 296) the program control information signal (276) and the designated program to subscribers, wherein the designated program is transmitted to subscribers at the designated programs start times (412).

36. The method of claim 18 further including method for compiling and using program watched data (420) containing information on programs wherein

30

program watched data is received from one or more remote locations, the method further characterized by the steps of:

receiving (402) program watched data;

designating (402) a program for analysis;

5 compiling (402) the received program watched data (420) for the designated program; and

 using the compiled program watched data (420) in the formation of a program line-up including:

 determining (430) whether the compiled data is favorable for

10 placing the designated program in a particular time slot; and

 allotting (430) a time slot for the designated program in the program line up.

37. The method of claim 35 wherein menus having menu space are filled using the program watched data, further characterized by the step of:

15 allocating menu space for the designated program using the program line-up.

38. The method of claim 18 wherein the packaging step includes a method for allocating a given amount of bandwidth for a plurality of television programs from the programs received by the receiving means (272), each of the programs corresponding to one of a plurality of genre categories, the allocation method including the steps of:

25 prioritizing (400) each of the programs by assigning to each of the programs one of a plurality of priority levels, the plurality of priority levels including a high priority level and progressively lower priority levels, whereby programs having a higher priority level will be accepted by systems having a limited bandwidth;

30 dividing the given amount of bandwidth so that each program category receives a portion of the given amount of bandwidth;

allocating (326) the given amount of bandwidth to high priority programs in each category; and

continuing the allocating step with the progressively lower priority levels until at least one of the following conditions occurs:

- 5 all programs are allocated,
 all of the given amount of bandwidth is allocated.

39. An operations center for use by a program packager to provide a television program delivery system, said operations center comprising:

10 a reception port for receiving television programs;
 external collection means for gathering television programs from external sources and feeding television programs from external sources to said reception port;

15 internal collection means, connected to said reception port, for gathering television programs from internal sources and feeding said television programs from internal sources to said reception port;

 a converter for converting any of said television programs that are in non-digital format to digital format;

20 packaging means for creating program control information and for packaging said digital format television programs using said program control information, said packaging means comprising:

 a central processing unit;

25 an interface, connected to the central processing unit, to enable a program packager to enter program line-up information, wherein said interface is operably connected to said central processing unit;

 storage means, connected to the central processing unit, for storing said entered program line-up information;

30 logic means, connected to the central processing unit, for arranging said stored program line-up information and for creating the program control information; and

means, connected to the logic means, for generating a digital program control information signal from the program control information;

5 combining means for creating a combined signal, said combined signal comprising the packaged digital format programs and the digital program control information signal; and

transmission means, operably connected to said packaging means, for transmitting said combined signal.

10 40. The operations center of claim 39, wherein said packaging means comprises means for generating menu configurations; and

said packaging means generates said program control information using said menu configurations.

15

41. The operations center of claim 39, said operations center further comprising:

means for receiving unique cable franchise control information from cable franchises;

20 means, connected to the receiving means, for storing said unique cable franchise control information; and

wherein said generating means is connected to the storing means and comprises means for including said unique cable franchise control information in said generated digital program control information signal.

25

42. A method for remotely generating a program control information signal for use by viewers using menus of available programming based on program line-up information, said method comprising the steps of:

30 obtaining and storing program line-up information for programs, the program line-up information comprising, program name, program start time, program duration, program category and program price;

arranging said program line-up information for said programs in a menu configuration;

creating program control information using said program line-up information;

5 generating a digital program control information data signal using said program control information; and

continuously transmitting said digital program control information data signal simultaneously with said programs.

10 43. A method of generating a digital program control data information signal for transmission to viewers receiving a simultaneously transmitted plurality of television programs so that variable video displays of current and future programming can be generated and so that the downstream displays of the television programs can be selected and controlled by the
15 viewers, the method uses stored marketing data, algorithms, and menus, the method comprising:

receiving input data, including program names, start times, program duration or program category and price;

20 combining the input data with the stored marketing data comprising the frequency with which programs are watched by viewers and the demographics of viewers:

weighing the combined data according to algorithms which assign a weight of importance to each type of data;

25 generating from the weighted data a program line-up and program positions on menu formats resulting in a draft menu;

displaying the resulting draft menu for editing;

editing the draft menu; and

processing the edited menu to generate the digital program control data information signal for transmission to viewers.

44. The method of claim 43 wherein the digital program control data information signal is transmitted to cable franchises and wherein the method further comprises:

- receiving specific information relating to each cable franchise that
5 receives the signal; and
- creating a customized signal for each cable franchise.

45. The method of claim 43 wherein the digital program control data information signal also contains information for identifying virtual
10 channels for interactive services and data services available to viewers using service information, the method further comprising:

- collecting service information on the data services available;
- inventorying the interactive services to be made available to the
viewer:
- 15 assigning a virtual channel for the data services and the interactive services;
- determining method of upstream transmissions for interactive services; and
- creating a menu for interactive services and data services for later
20 processing.

46. A method to assist a program packager to create a transmissible data information signal which organizes stored information on television programs available for viewing into program line-ups and generates a
25 program control information signal from the program line-ups to enable selection of television programs for viewing by viewers, the method comprising:

- receiving information on television programs available for
viewing;
- 30 organizing the information on television programs available for viewing into program line-up information using stored computer instructions including a set of computer instructions for utilizing stored

data to optimize the selection of television programs to be watched by each viewer;

editing the program line-up information;

generating the program control information signal using the
5 program line-up information; and

transmitting the program control information signal as a digital data signal so that the television programs from which a viewer can choose will be displayed for selection by a viewer.

10 47. The method of claim 46 further comprising gathering of program watched information from viewers, and wherein the organizing step further comprises:

targeting a television program; and

managing the yield of the programs watched information for the
15 targeted program so that the targeted program yields higher programs watched information.

48. The method of claim 46 wherein at least one of the television programs is a program service comprising a time limited series of
20 programming offered for a defined time each day for a limited number of calendar days and wherein the program control information signal comprises information providing an identification and description of the service, the starting and stopping dates and the times each day that the service can be viewed by the viewers.

25

49. A method to create program services containing at least one program and an interstitial audio/video for transmission, comprising:

obtaining one or more programs and interstitial audio/video;

creating events comprising:

30 combining one or more programs with one or more interstitial audio/video so that an event is longer than the one or more combined programs; and

creating an event identification for recalling the event;

generating program services comprising:

integrating one or more events using the event identification so that there are no disruptions to the programs or interstitial audio/video;

determining calendar days that the program services will be transmitted:

defining time of day that the program services will be transmitted; and

transmitting the program services containing the integrated events on the determined calendar days at the defined time.

50. The method of claim 49 wherein program services are paid for by viewers, the method further comprising:

creating a mini-pay consisting of one or more program services;

and

assigning a price to the mini-pay.

51. A method for generating a program control information signal for near video on demand service using programs wherein the near video on demand service is transmitted from a central location for distribution to subscribers, comprising:

designating a program to be available to subscribers more than once during a day;

evaluating the length of the designated program;

creating program start times using the evaluated length of the program;

organizing a program line-up with the designated program and the program start times so that the program appears in the program line-up more than once and wherein more than one designated program is in the program line-up;

generating the program control information signal using the organized program line up for transmission.

52. The method of claim 51 wherein designated programs may be demanded within fifteen minutes, the step of creating program start times comprises:

dividing the evaluated program length into multiple fifteen minutes segments and one last segment; and

identifying interstitial audio/video to be added to the last segment.

10

53. The method of claim 51 wherein a monitor is used further comprising:

graphically reorganizing the program line up using a monitor before generating the program control information signal.

15

54. A method for creating near video on demand service using programs wherein the near video on demand service is transmitted from a central location for distribution to subscribers, comprising the steps of:

20 designating a program to be available to subscribers more than once;

evaluating the length of the designated program;

creating program start times using the evaluated length of the program;

25 organizing a program line-up using the program start times so that the program appears in the program line-up more than once;

generating a program control information signal using the organized program line-up;

30 transmitting the program control information signal and the designated program to subscribers, wherein the designated program is transmitted to subscribers at the designated program's start times.

55. A method for compiling and using program watched data containing information on programs wherein the program watched data is received from one or more remote locations, comprising the steps of:

receiving the program watched data;

5 designating a program for analysis;

compiling the received program watched data for the designated program; and

using the compiled program watched data in the formation of a program line-up comprising:

10 determining whether the compiled data is favorable for placing the designated program in a particular time slot; and

allotting a time slot for the designated program in the program line up.

15 56. The method of claim 55, wherein menus having menu space are filled using the received program watched data, further comprising the step of:

allocating menu space for the designated program using the program line-up.

20

57. A centralized operating center for packaging a large number of diverse television programs for selective remote display by viewers, the operating center comprising:

25 means for receiving television programs in analog or digital format, each having video and audio components;

means, connected to the receiving means, for coordinating the receipt of the television programs;

input means for receiving input commands and specific information about each of the television programs;

30 database means, connected to the input means, for storing and supplying information about the television programs, comprising:

a central processing unit that analyzes information from the database means and the input means to generate a program control information signal, the signal contains specific identification concerning each television program received by the receiving means, including the date and time of display and the category into which the television program falls;

means, connected to the database means and receiving means, for combining the subset of television programs identified in the program control information signal in preparation for transmission;

multiplexing means, connected to the combining means, for multiplexing the combined television programs and the program control information signal for transmission; and

transmitting means, connected to the multiplexing means, for simultaneously transmitting the multiplexed program control information signal along with the multiplexed television programs so that video displays can be generated from the program control information signal and so that the downstream displays of the television programs can be selected and controlled by the viewers.

58. A centralized operating center for packaging a large number of diverse television programs for selective remote display by viewers using information about television programs, the operating center comprising:

a receiver, wherein television programs are received in analog or digital format, each having video and audio components;

a keyboard, wherein input commands are entered;

a memory, wherein the information about the television programs is stored;

a processor, operably connected to the memory and keyboard, wherein a program control information signal is generated using information stored in the memory and commands entered on the keyboard, the program control information signal containing specific identification

concerning each television program in a subset of television programs received by the receiver, including the date and time of display comprising:

5 a combiner, operably connected to the processor and receiver, wherein the subset of television programs identified in the program control information signal are combined in preparation for transmission;

10 a multiplexer, connected to the combiner, wherein the combined television programs and the program control information signal are multiplexed for transmission; and

15 a transmitter, connected to the multiplexer, wherein the multiplexed program control information signal is simultaneously transmitted along with the multiplexed television programs so that video displays can be generated using the program control information signal and so that the downstream displays of the television programs can be selected and controlled by the viewers.

59. An operations center for use by a program packager in a television program delivery system, said operations center comprising:

20 a reception port, wherein television programs are received;

a local video storage database, operably connected to the reception port, wherein television programs are stored;

25 a converter, operably connected to the reception port, wherein television programs that are in not in digital format are converted to digital format;

a computer assisted packaging system, operably connected to the local storage, wherein program control information is created and digital format television programs are packaged using the program control information, said packaging system comprising:

30 a central processing unit;

an interface, operably connected to the central processing unit, wherein a program packager may enter program line-up information;

5 a database, operably connected to the central processing unit, wherein the entered program line-up information is stored:
and

wherein the central processing unit arranges the stored program line-up information and creates the program control information and generates a program control information signal
10 from the program control information;

a combiner, connected to the computer assisted packaging system, wherein a combined signal is created, the combined signal comprising the packaged digital format programs and the program control information signal; and

15 a transmitter, operably connected to the combiner, for transmitting said combined signal.

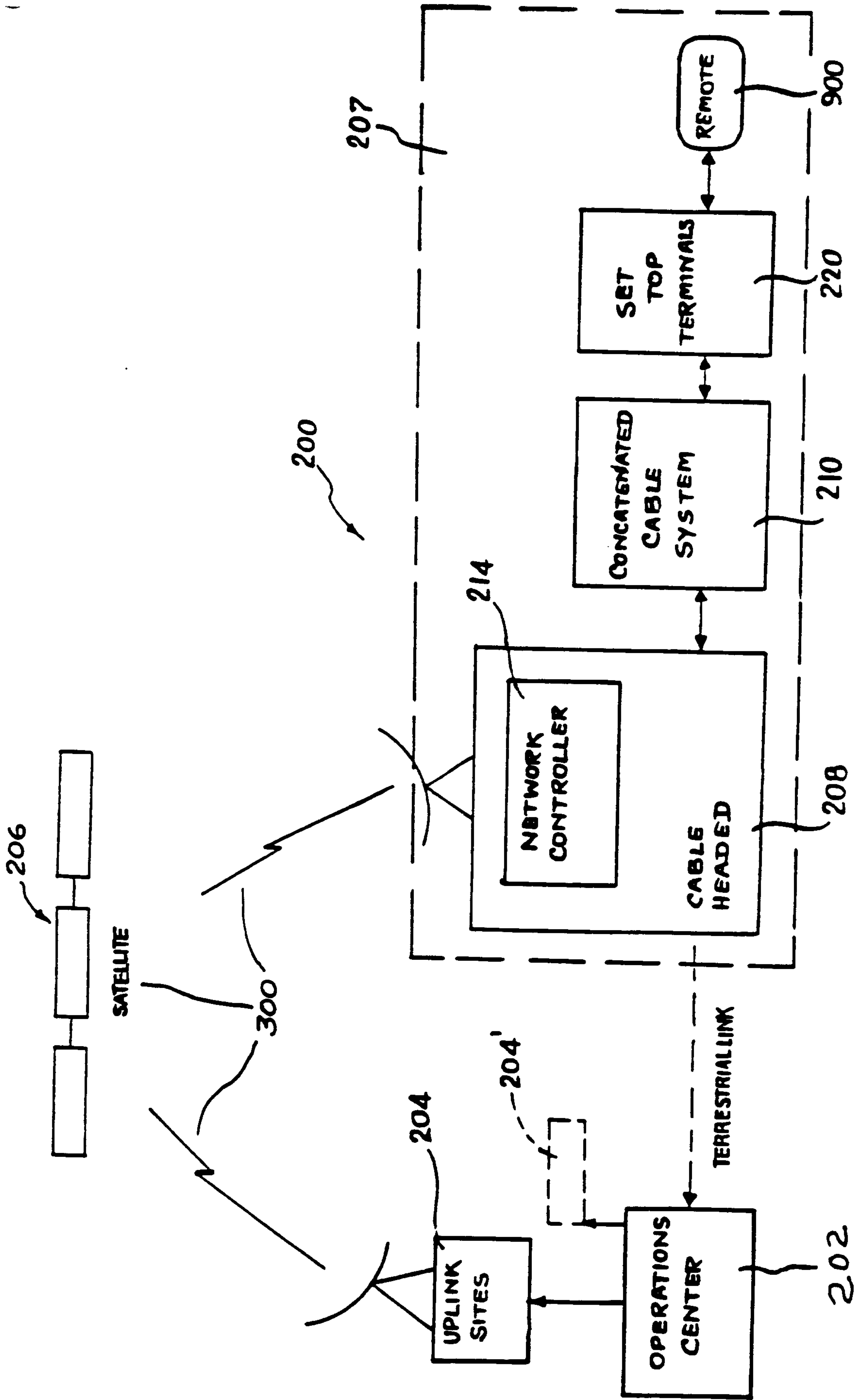

Fig. 1

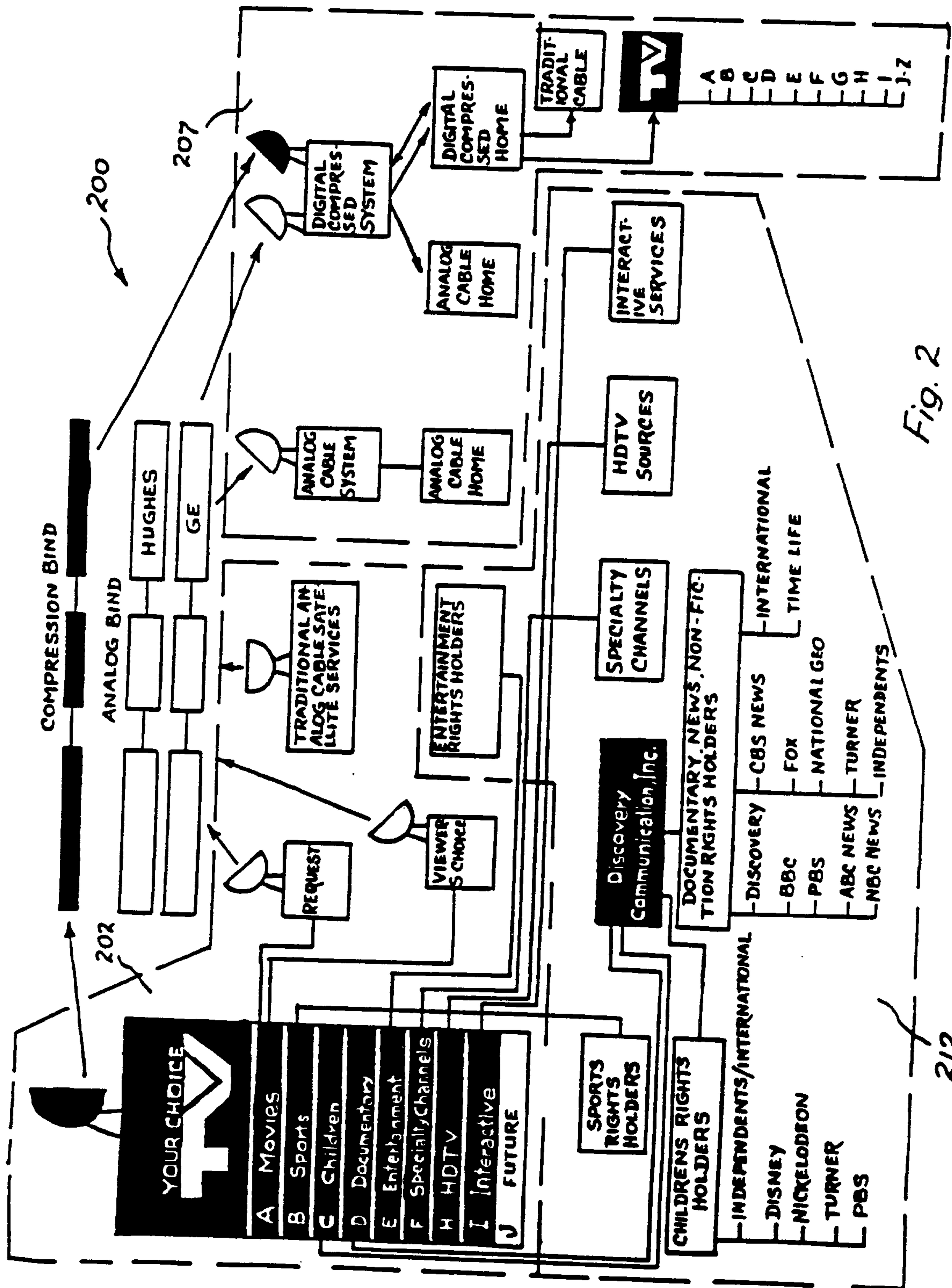

Fig. 2

212

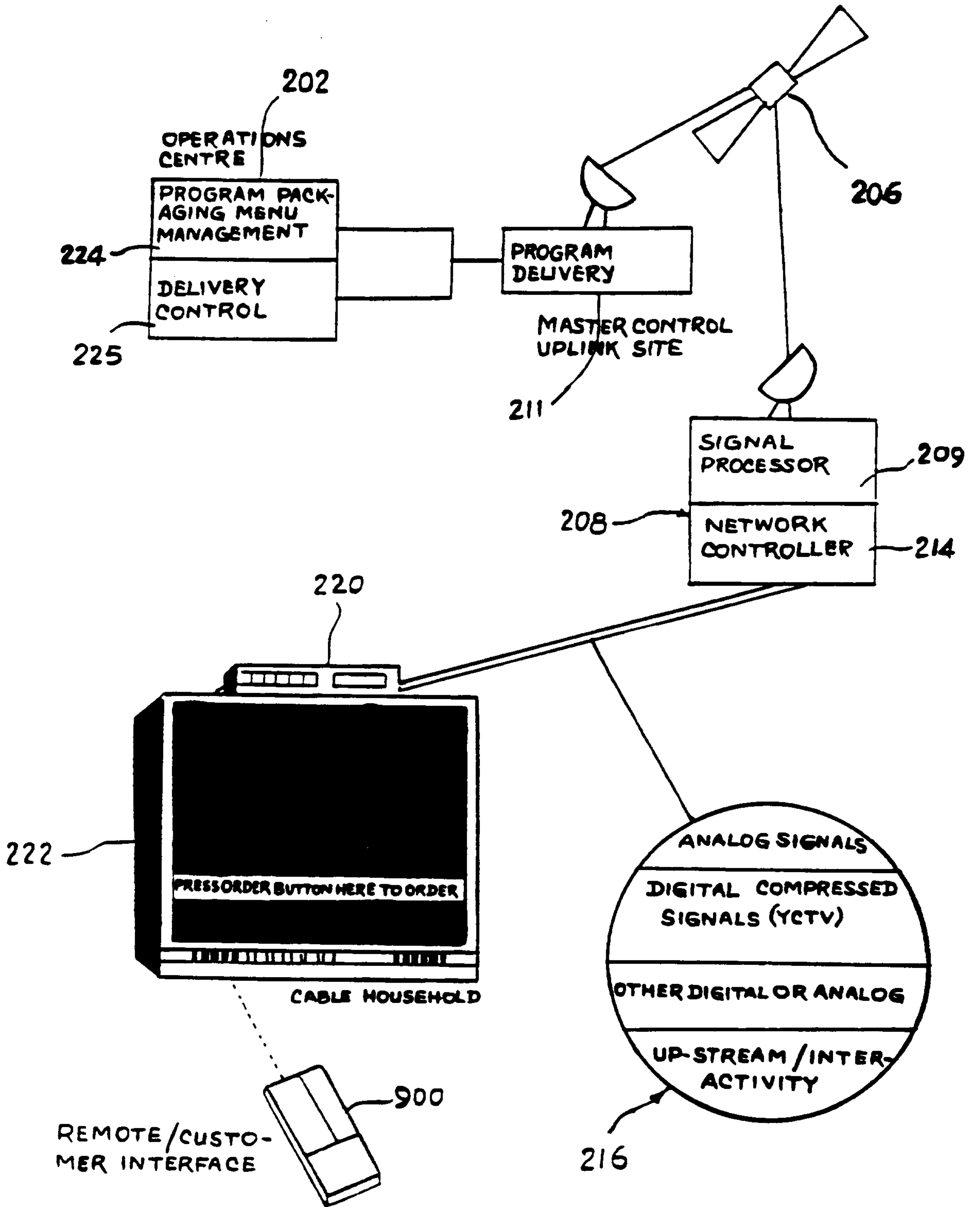

Fig. 3

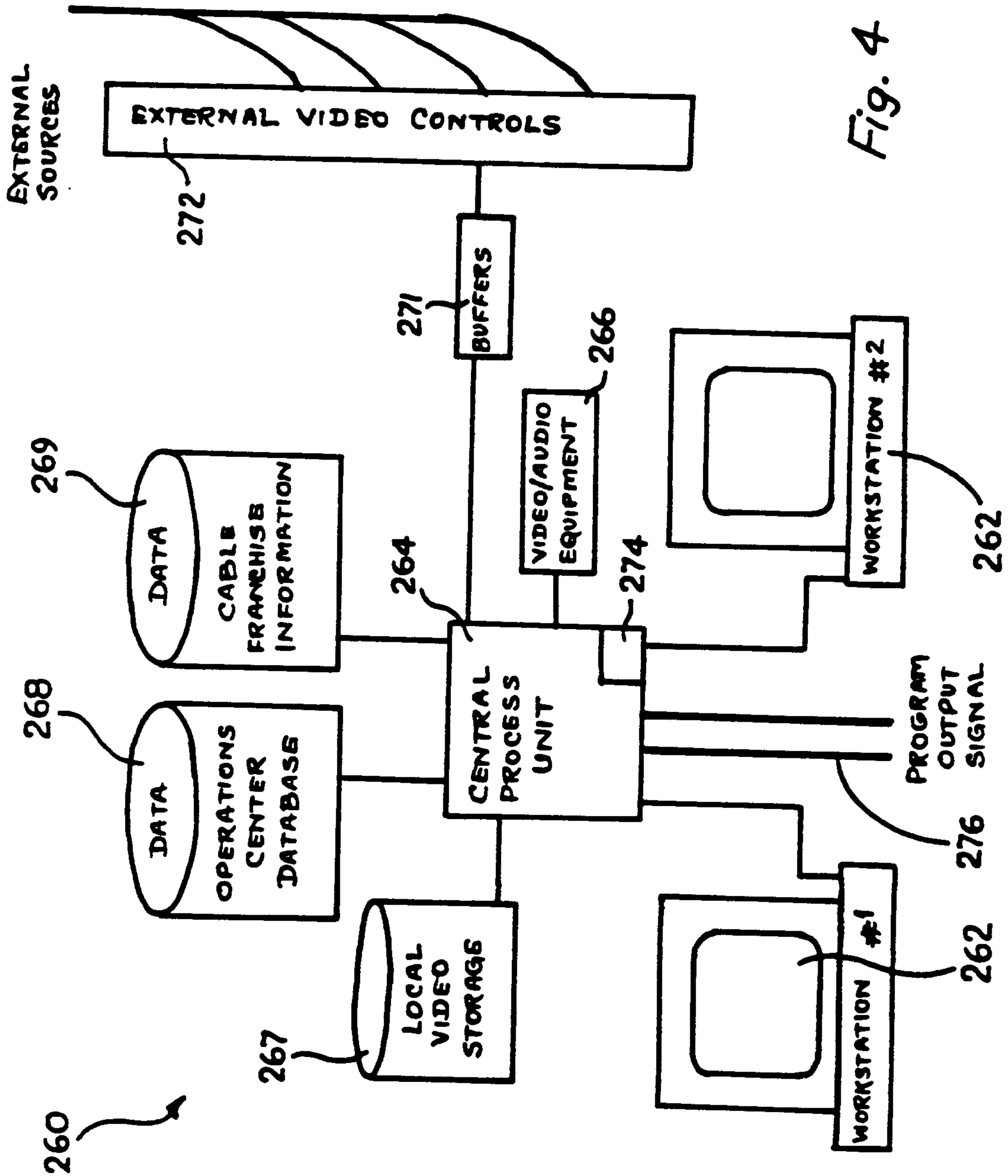

Fig. 4

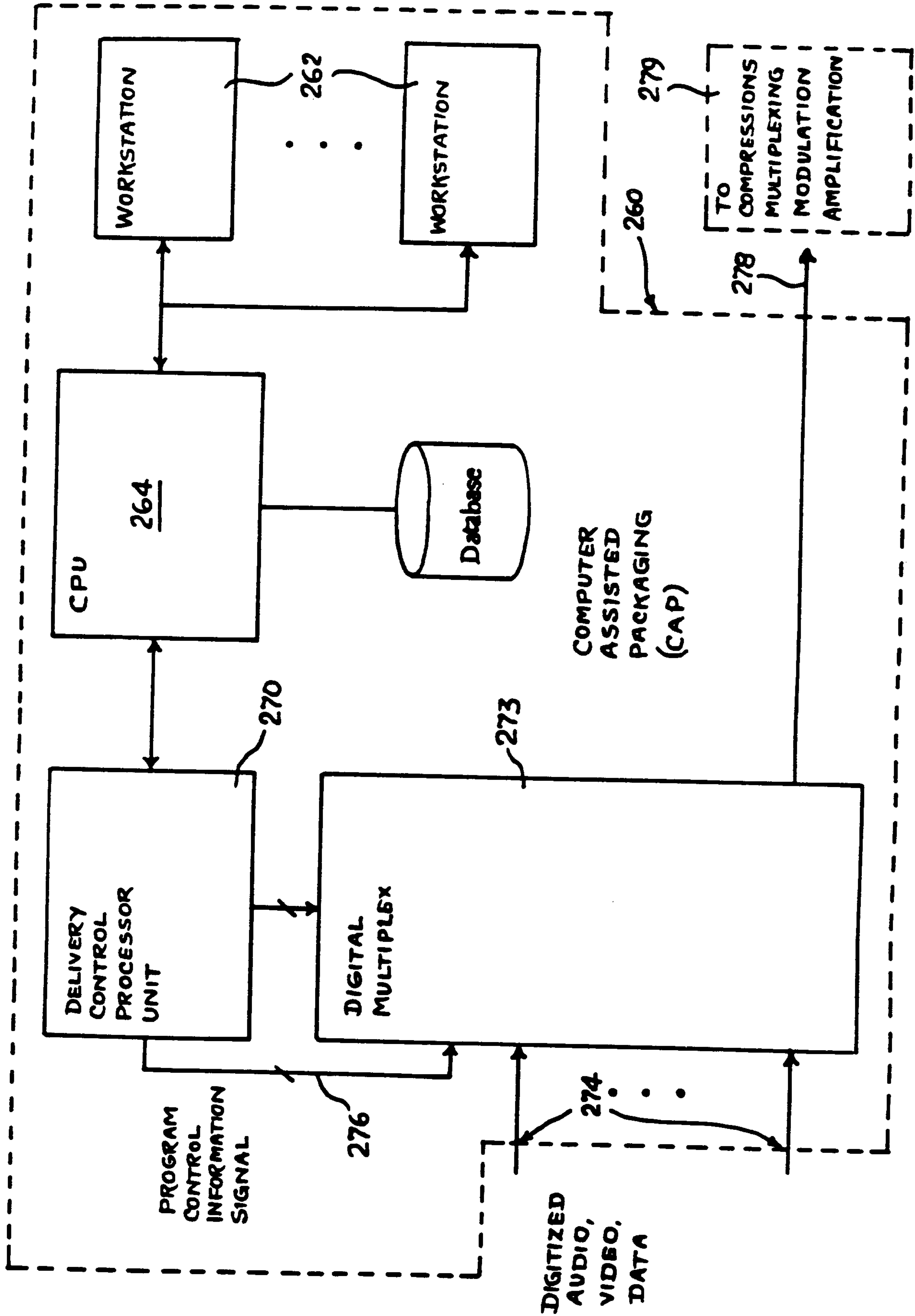
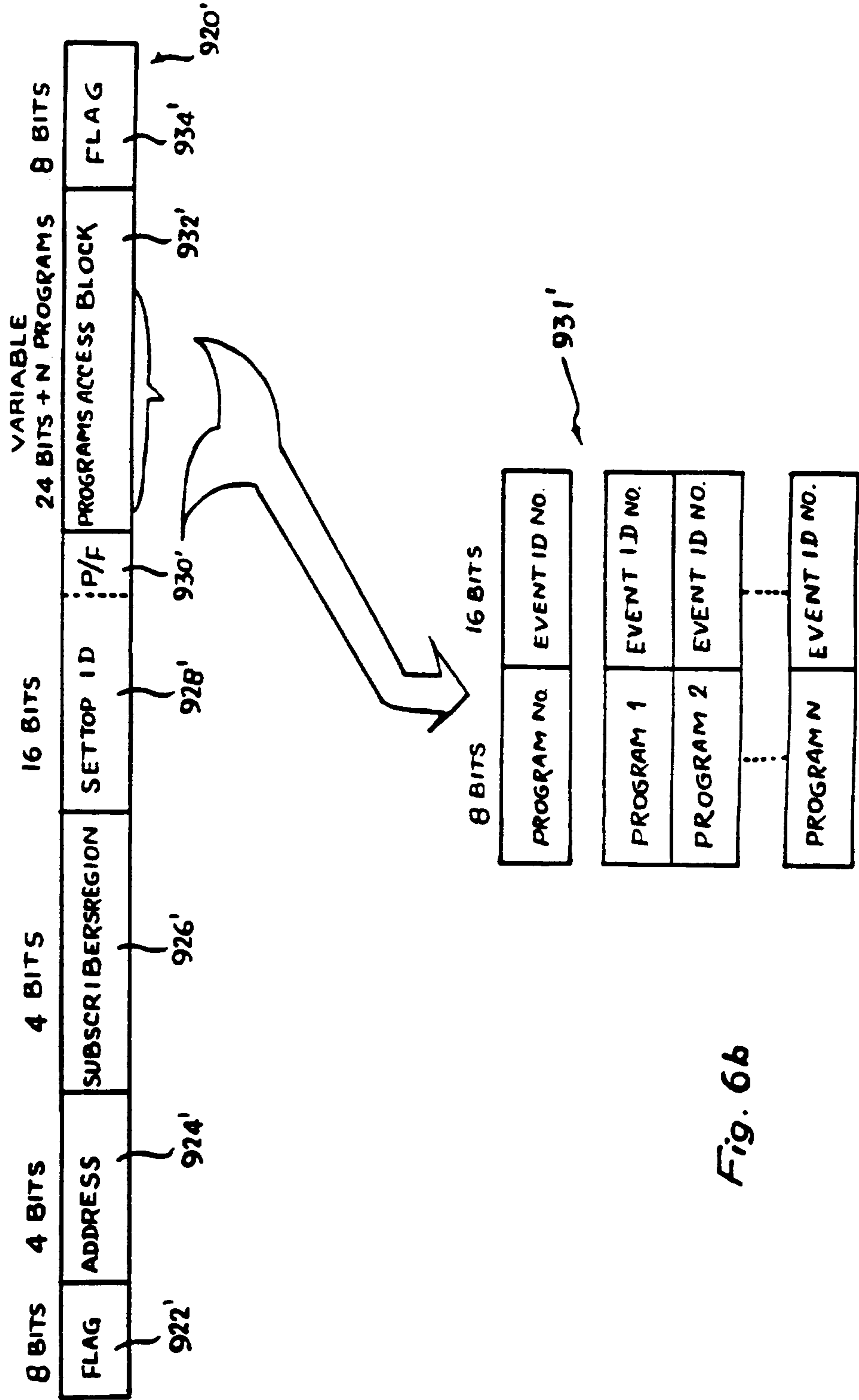
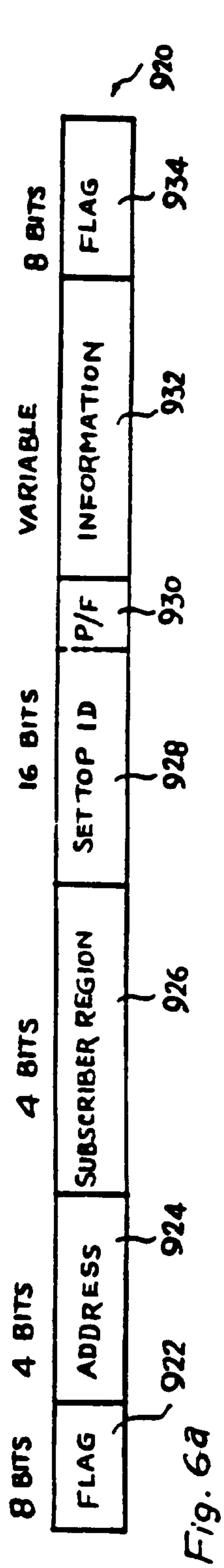

Fig. 5



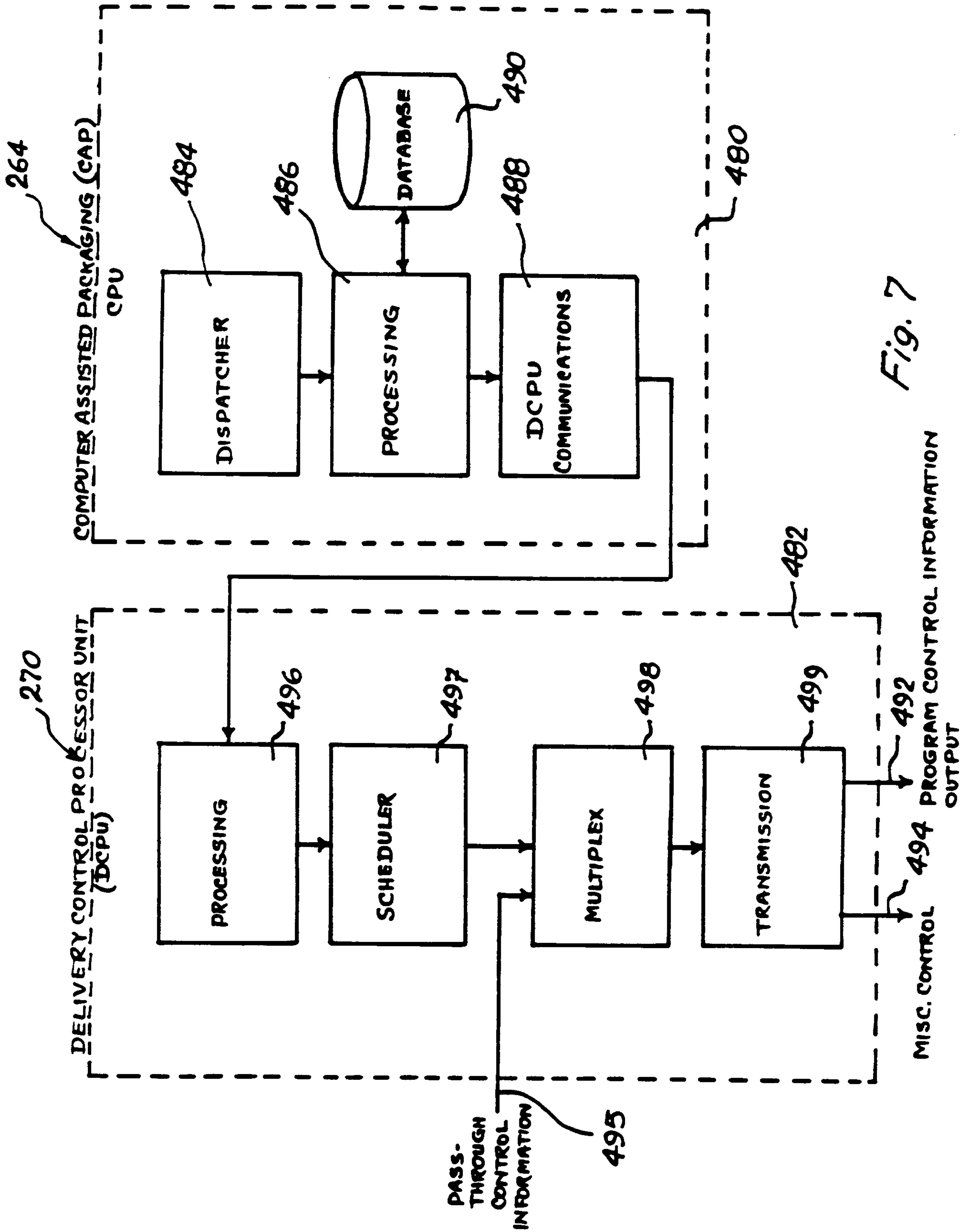

Fig. 7

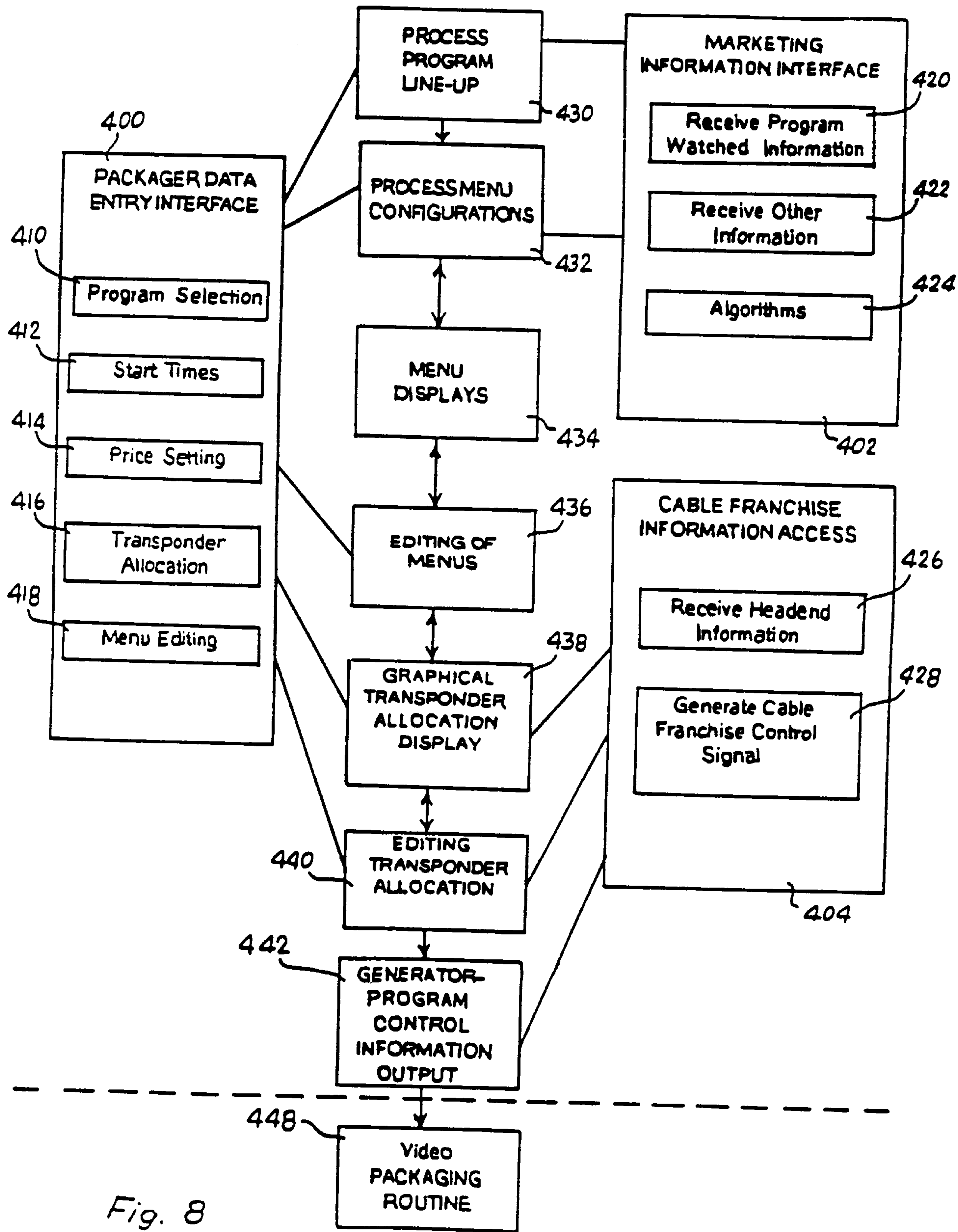

Fig. 8

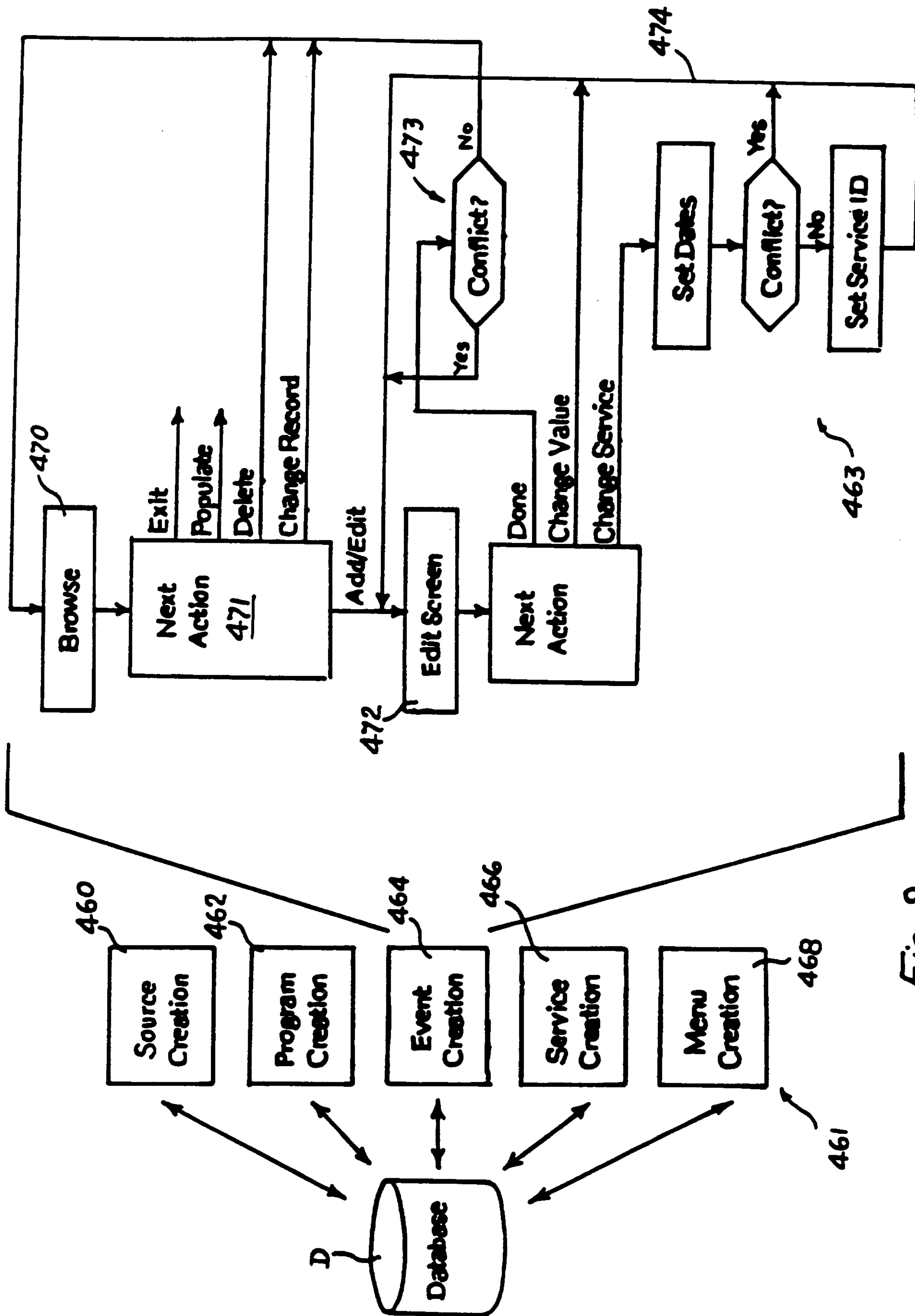

Fig. 9

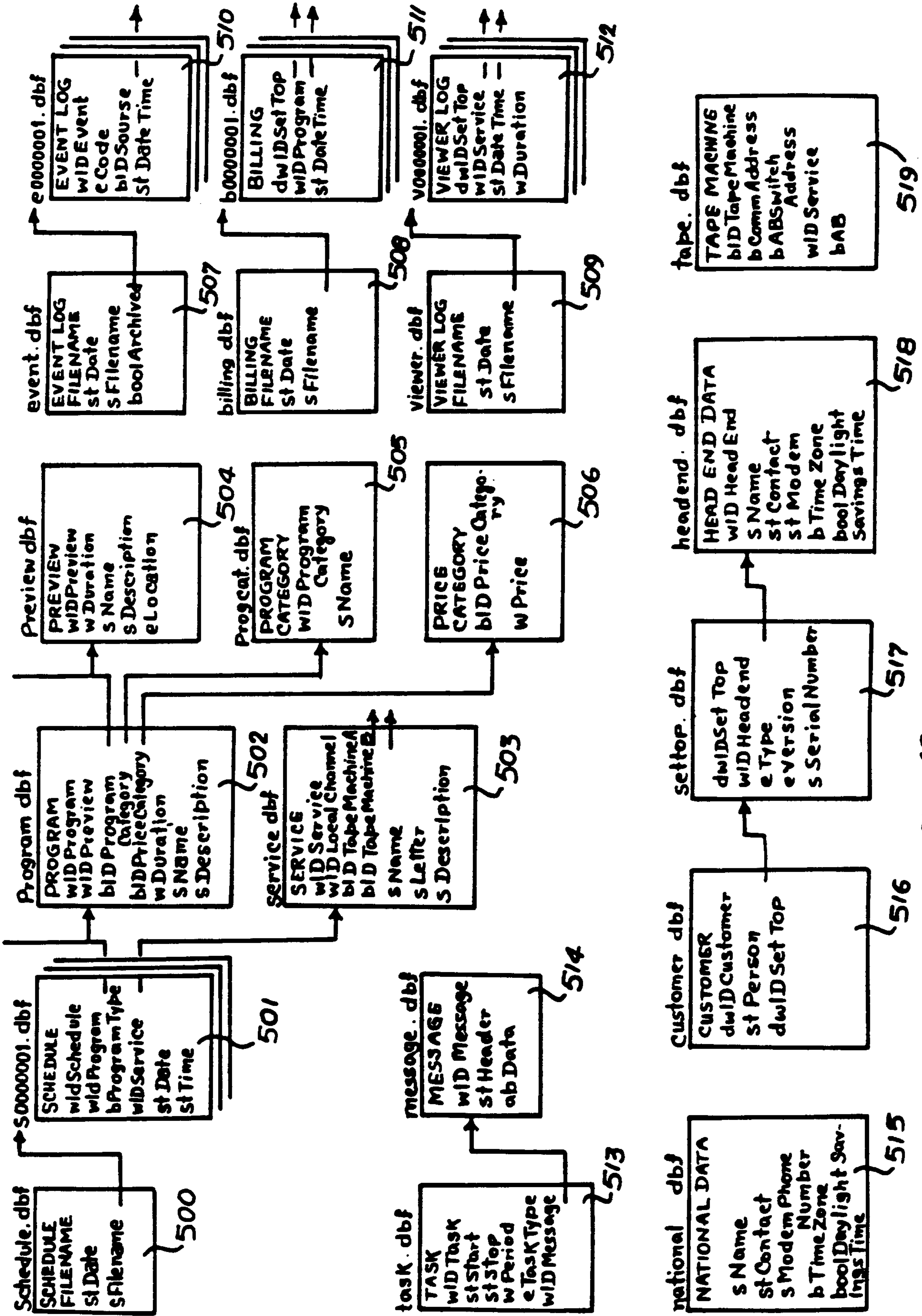

Fig. 10

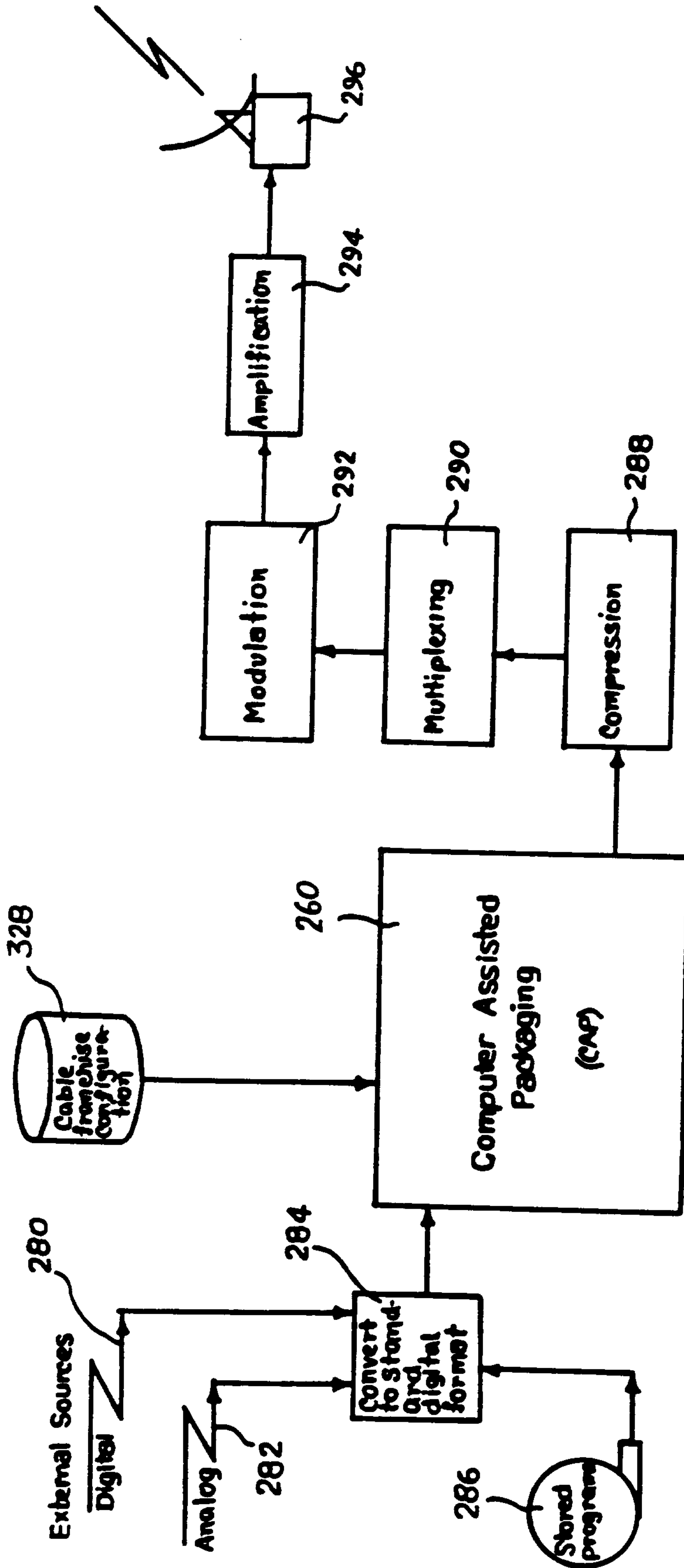

Fig. 11

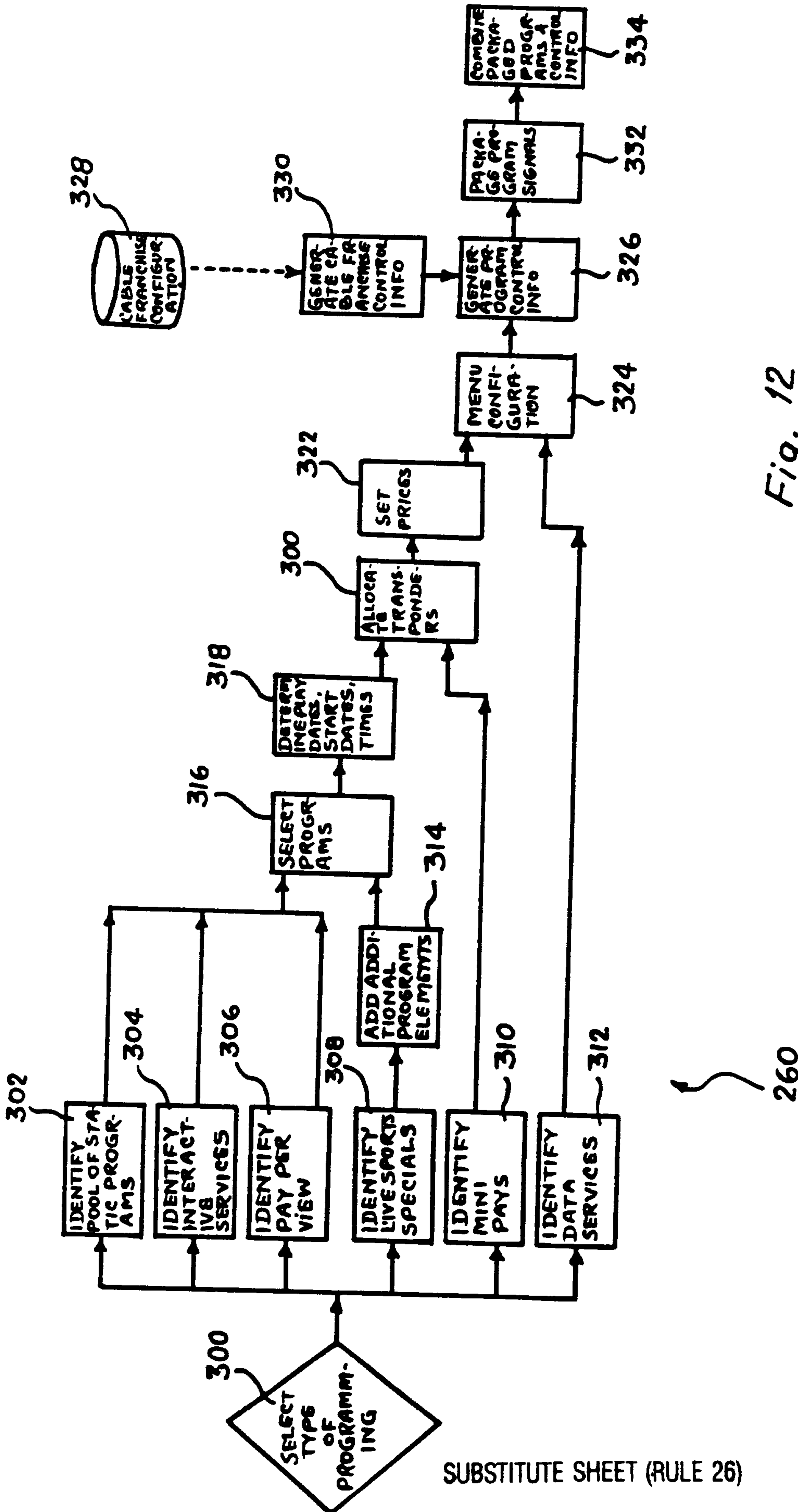

Fig. 12

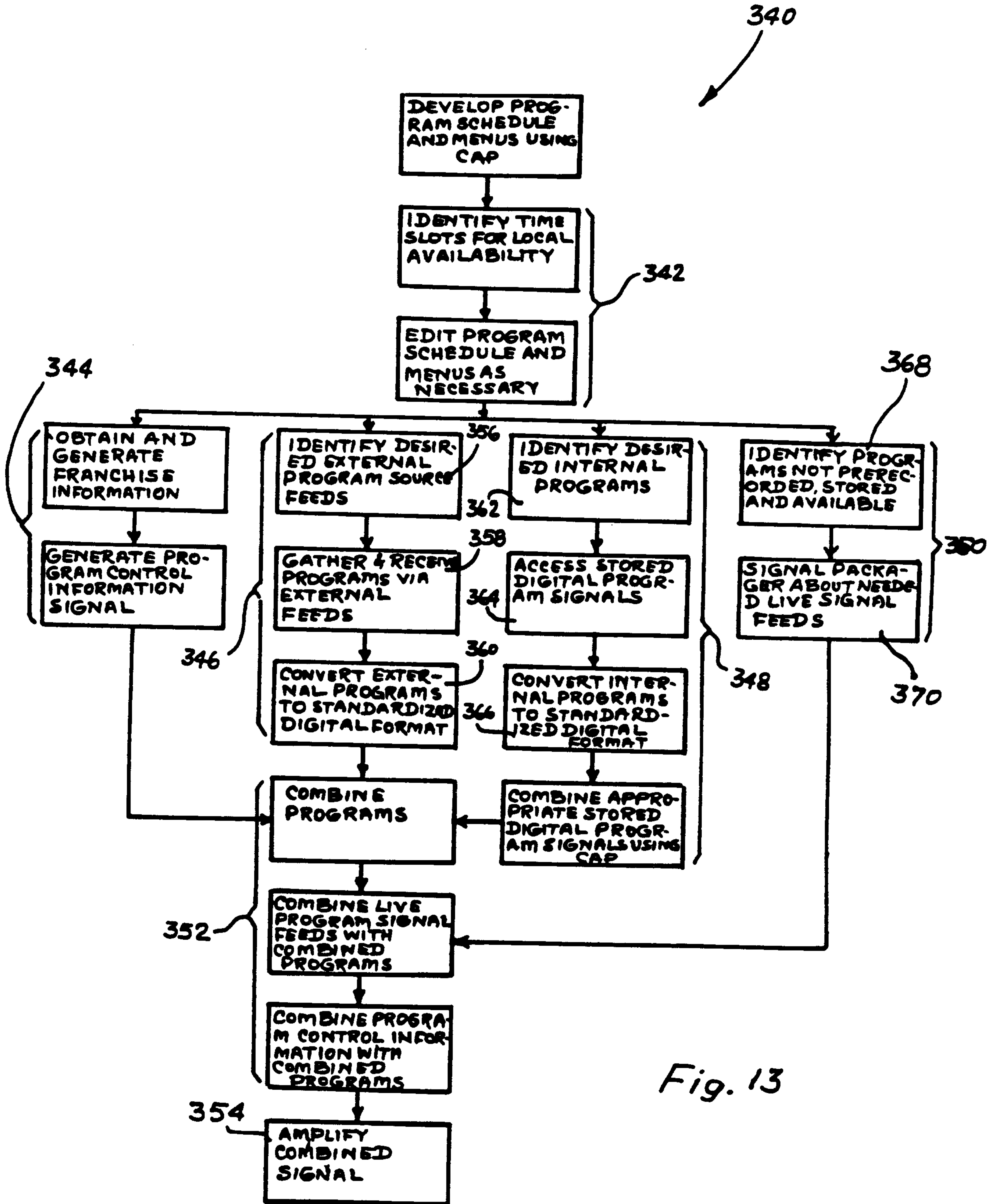

Fig. 13

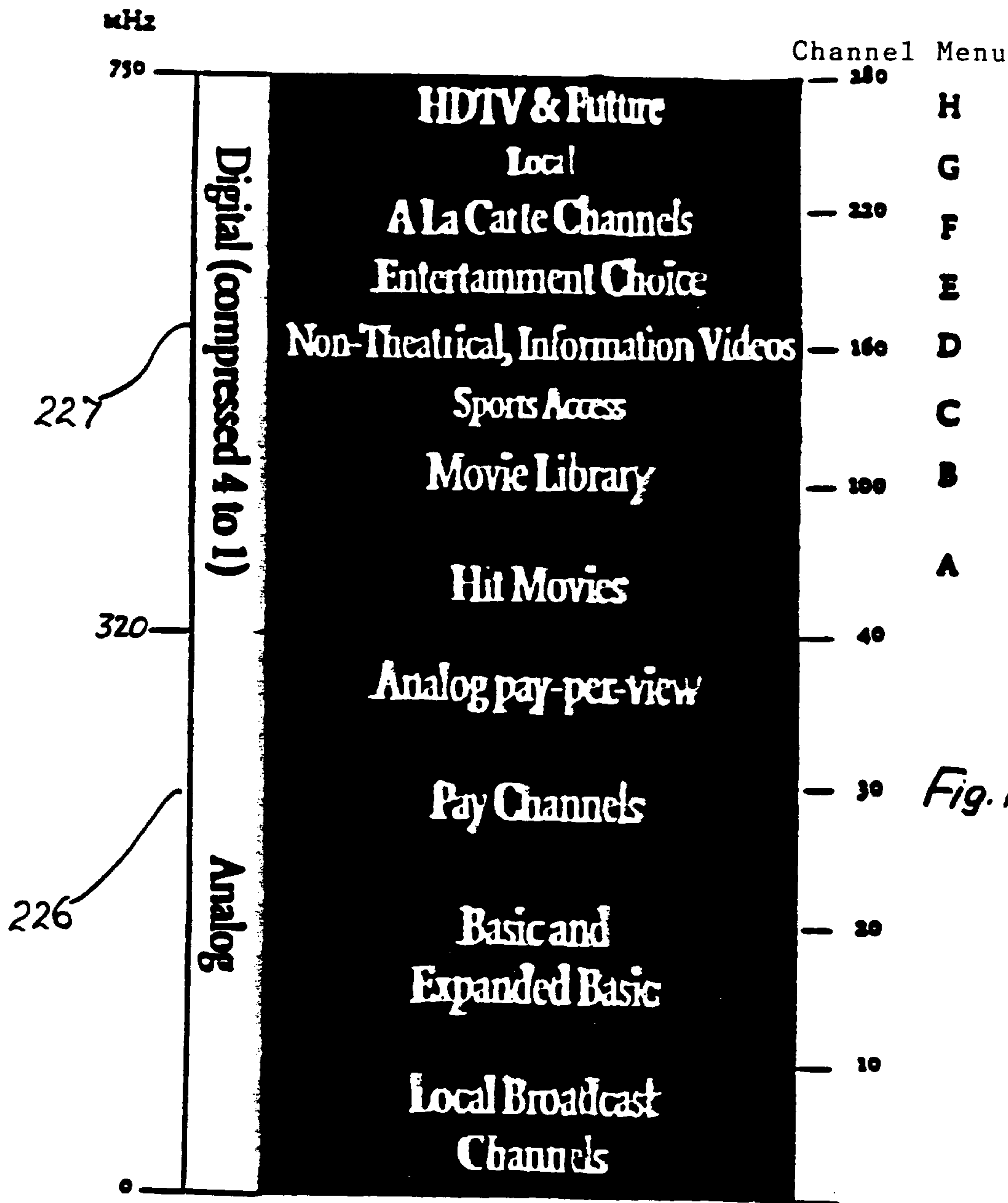

Fig. 14

CHANNEL MENU	PROGRAMMING CATEGORY	CHANNEL ALLOCATED
A	Movies	50
B	Sports	2
C	Childrens	3
D	Documentary	14
E	Entertainment	10
F	Specialty Channels	15
G	Local	N/A
H	HDTV	4
I	Interactive	2
	COMBINED	100

Fig. 15

SATELLITE MOVIE
OPTIONS

VTV Combo	Comp. Ratio	AVAILABLE MENUS (1, 2, & 3)	PRIORITY ONE MENUS	PRIORITY ONE PLUS TWO MENUS
1	8:1	HIT MOVIES 8 movie Selections with start times every 15 minut	HIT MOVIES 6 movie Selections with start times every 30 minutes	HIT MOVIES 6 movie Selections with start times every 15 minutes
2	8:1			
3	8:1			
4	8:1			
5	8:1			
6	8:1			
7	8:1			
8	8:1			
9	4:1	SPORTS 8 Selections	SPORTS 4 Selections	SPORTS 4 Selections
10	4:1			
11	8:1	CHILDRENS 8 Selections	CHILDRENS 4 Selections	CHILDRENS 4 Selections
12	8:1	DOCS/News 8 selections	DOCS/News 4 Selections	DOCS/News 4 Selections
13	8:1	ENTERTAINMENT 8 selections	ENTERTAINMENT 6 Selections	ENTERTAINMENT 6 Selections
14	8:1	SPECIAL-INTEREST channels 16 Selections	SPECIAL-INTEREST channels 8 Selections	SPECIAL-INTEREST channels 4 Selections
15	8:1			
16	8:1	Promos (1/6 screen) 48	Promos (1/6 screen) 48	Promos (1/6 screen) 48
17	8:1 OR 2:1	Data Stream	Data Stream	Data Stream
18	8:1 OR 2:1	MUSIC 32 digitized Station	MUSIC 16 digitized Stations	MUSIC 32 digitized Stations

Fig. 16

244

240

242

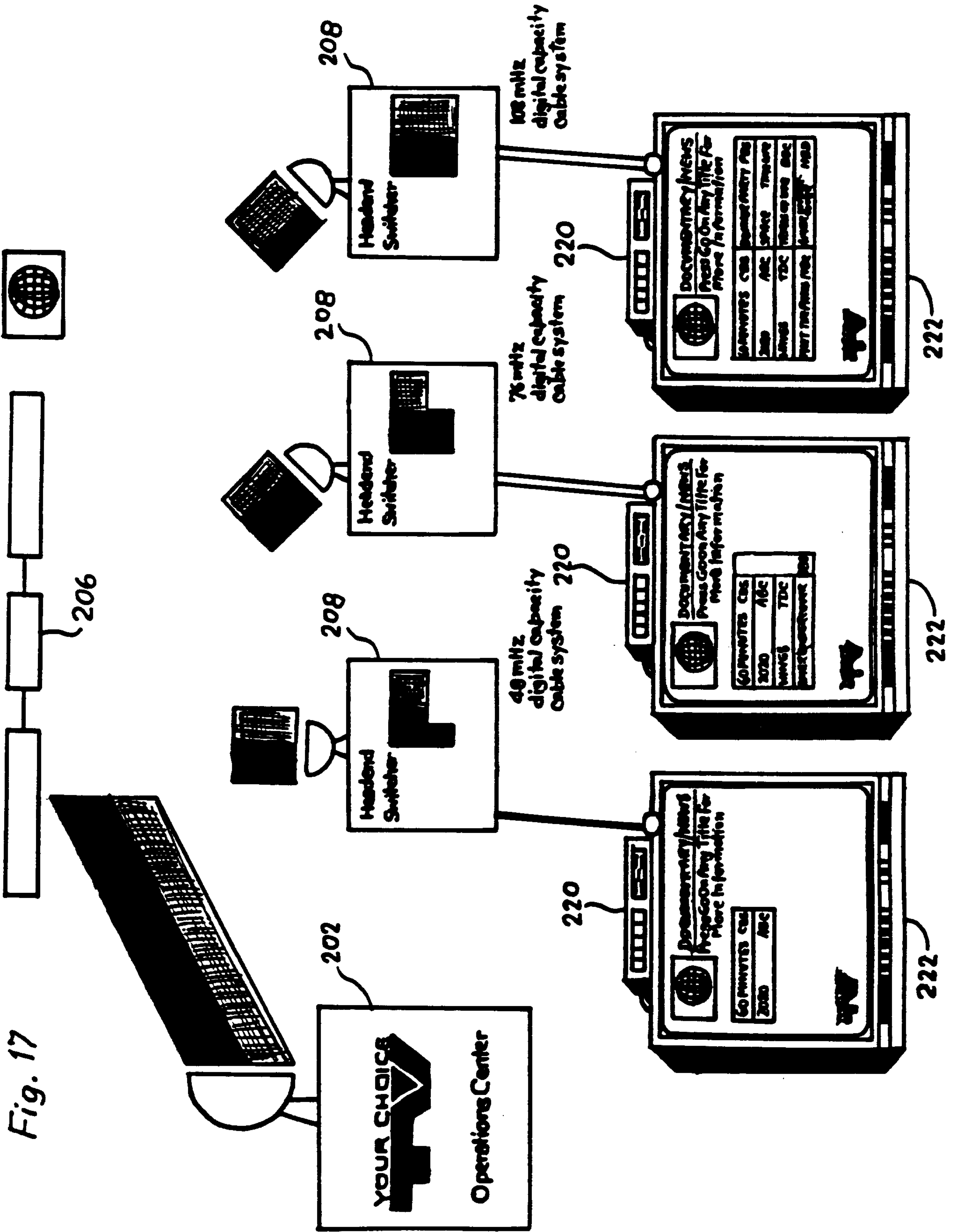

Fig. 17

VCTV Combo	Comp. Ratio	TYPICAL WEEKDAY PRIME	SATURDAY AFTERNOON IN OCTOBER
1	8:1	Hit Movies 8 movie selections with start times every 15 minutes	Hit Movies 8 movie selections with start times every 15 minutes
2	8:1		
3	8:1		
4	8:1		
5	8:1		
6	8:1		
7	8:1		
8	8:1		
9	4:1	Sports 8 Selections	sports 16 Selections 253
10	4:1		
11	8:1	Children's 8 Selections	Children's 8 Selections
12	8:1	Doc/News 8 Selections	Doc/News 8 Selections
13	8:1	Entertainment 8 Selections	Entertainment 8 Selections
14	8:1	Special Interest Channels 16 Selections	Special Interest Channels 8 Selections
15	8:1		
16	8:1	Promos (1/6 every 4)	Promos (1/6 every 4)
17	8:1	Data Stream	Data Stream
18	8:1 or max	Music 200 digital selections	Music 200 digital selections

251

250

252

Fig 18

SUBSTITUTE SHEET (RULE 26)

Fig. 19

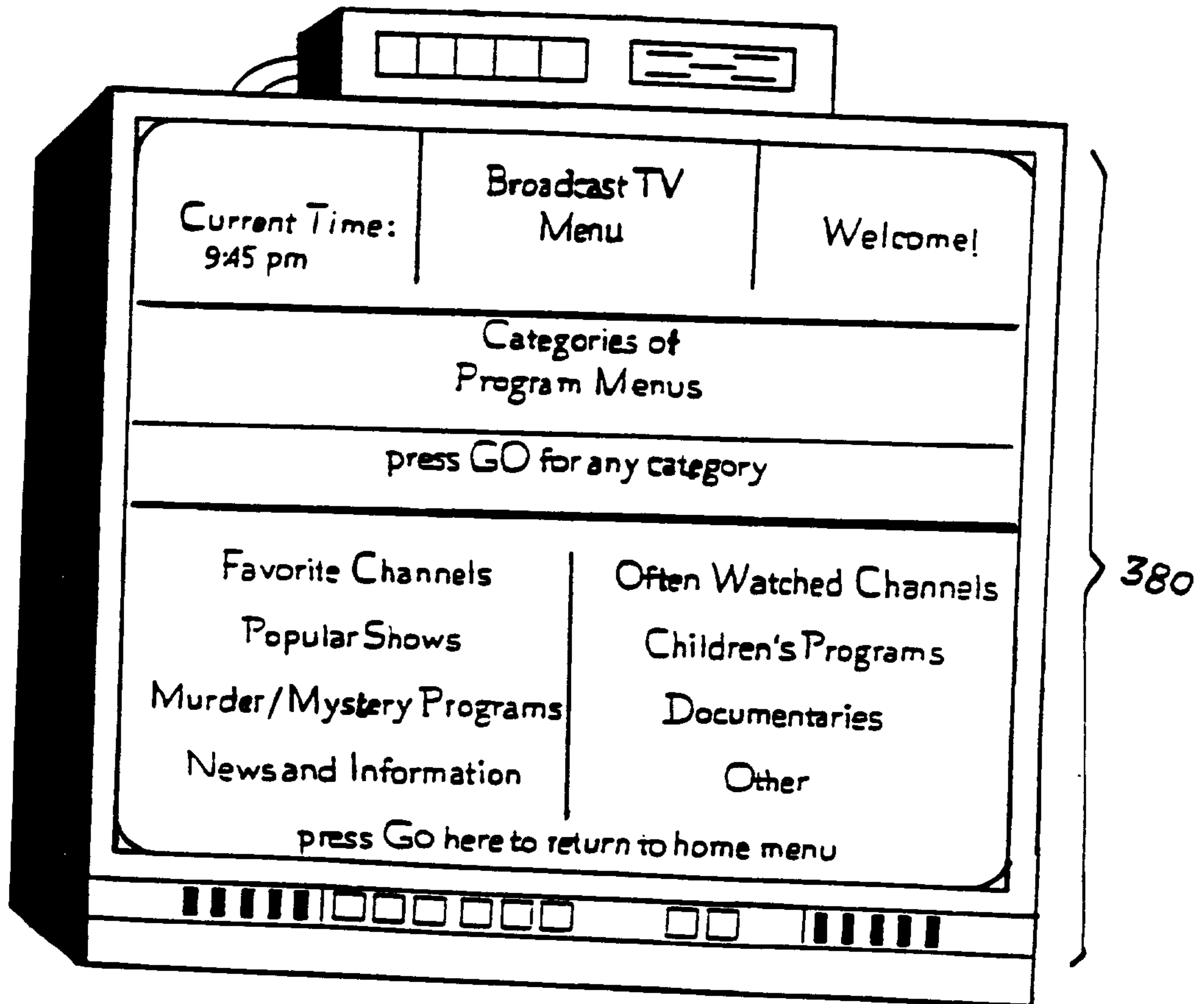

2151458
19/20

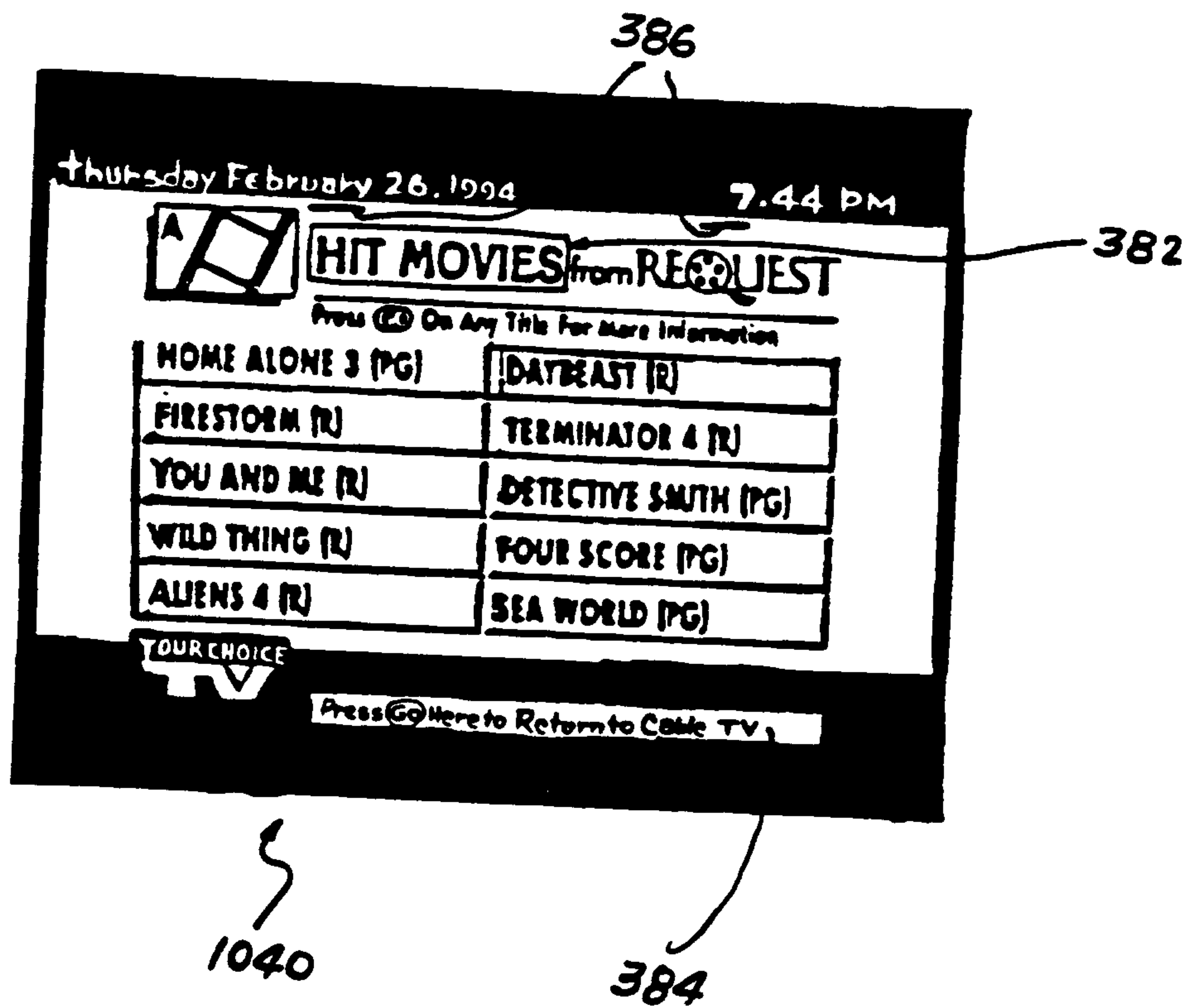
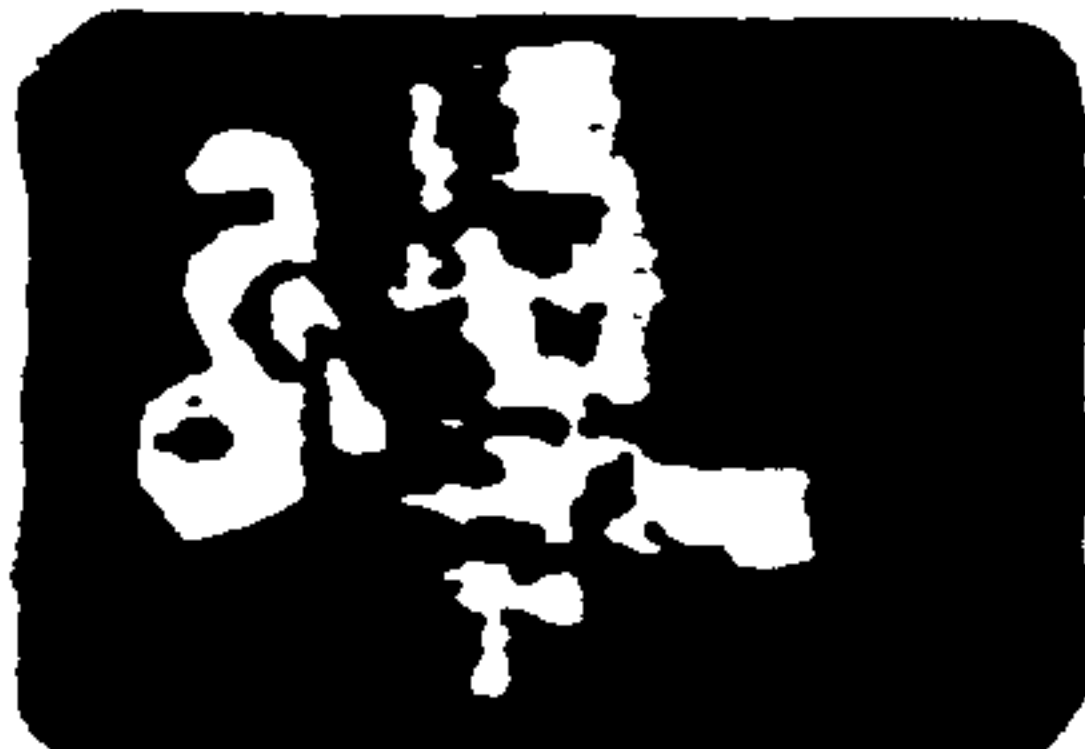

Fig. 20

20/20

Thursday February 26 1994 7.45 PM
Next start time 8.00 PM

TERMINATOR 4 (R)



Arnold Schwarzenegger Returns Again In This Sci-fi Action Thriller Set In The Present 2025 and In The Far Future 9010 AD

\$1.95 Running time 2:34
Circle Theatrical Release Press **0** Here to ORDER

YOUR CHOICE
TV Press **0** Here to Return to Menu A
Press **0** Here to Return to Cable TV

↑
1120

Fig. 21

